

Operating Manual



CAL 3300 and 9300
Autotune Temperature
Controllers



CAL Controls
Temperature Controllers

SAFETY & WARRANTY	A1	SECOND SETPOINT (SP2)	12
FUNCTIONS MENU	A3	SP2 as an alarm	12
QUICK START		SP2 subsidiary mode	13
Quick Start Set-up	1a	SP2 as a proportional output	13
INTRODUCTION	2	SP2 alarm condition table	13
The controllers	2	SP2 alarm annunciator	13
OVERVIEW	3	ERROR MESSAGES	14
Installation	3	Recommendations	14
Set-up	3	Autotune data in <i>tECH</i>	14
Autotune	3	IMPROVING CONTROL ACCURACY	15
Cycle-time	4	Using <i>ChEK</i> accuracy monitor	15
SET-UP	5	FUNCTION LIST	16
Power-up	5	Level 1	16
Select input sensor	5	Level 2	18
Select display units	5	Level 3	19
Allocate output device	5	Level 4	21
Enter initial configuration	5	OUTPUT OPTIONS	22
Set main setpoint	5	ADVANCED SETTINGS	23
MENU NAVIGATION	6	Heat Cool strategy	23
Using program mode	6	Calibration to other instrument	24
AUTOTUNE	7	Linear input calibration	25
Tune program	7	MECHANICAL INSTALLATION	27
Tune at setpoint program	8	DIN panel cut-outs	27
PROPORTIONAL CYCLE-TIME	9	Minimum spacing	27
Cycle-time selection methods	9	Mounting	28
Cycle-time recommendations	9	ELECTRICAL INSTALLATION	29
Autotune calculated cycle-time	9	General requirements	29
PROGRAMMER	11	Connection diagrams	30
Ramp-Soak	11	INPUT/SENSOR SELECTION	31
		SPECIFICATION	32



SAFETY AND WARRANTY INFORMATION

INSTALLATION



Designed for use:

UL873 - only in products where the acceptability is determined by Underwriters Laboratories Inc.

EN61010-1 / CSA 22.2 No 1010.1 - 92

To offer a minimum of Basic Insulation only.

Suitable for installation within Category II and III and Pollution Degree 2.

SEE ELECTRICAL INSTALLATION P29 & P30

It is the responsibility of the installation engineer to ensure this equipment is installed as specified in this manual and is in compliance with appropriate wiring regulations.

CONFIGURATION

All functions are front selectable, it is the responsibility of the installing engineer to ensure that the configuration is safe. Use the program lock to protect critical functions from tampering.

ULTIMATE SAFETY ALARMS

Do not use SP2 as the sole alarm where personal injury or damage may be caused by equipment failure.

WARRANTY

CAL Controls warrant this product free from defect in workmanship and materials for three (3) years from date of purchase.

- 1 Should the unit malfunction, return it to the factory. If defective it will be repaired or replaced at no charge.
- 2 There are no user-servisable parts in this unit. This warranty is void if the unit shows evidence of being tampered with or subjected to excessive heat, moisture, corrosion or other misuse.
- 3 Components which wear, or damage with misuse, are excluded e.g. relays.
- 4 CAL Controls shall not be responsible for any damage or losses however caused, which may be experienced as a result of the installation or use of this product. CAL Controls liability for any breach of this agreement shall not exceed the purchase price paid E. & O.E.

FUNCTIONS MENU

KEY ★ OR ▲ TOGETHER TO CHANGE LEVELS OR OPTIONS
KEY ★ ▼ OR ▲ TO VIEW FUNCTIONS

LEVEL 4	LOCK PRO NO AL D SS DER S													
USER-PROTECTED SETTINGS														
LEVEL 3	SP1 ID	SP2 ID	BURN	RELD	REUL	SPAN	ZERO	CHEV	READ	TECH	VER	RSET		
CONFIGURE OUTPUT SAFETY SETTINGS CALIBRATION PERFORMANCE DATA														
LEVEL 2	SP1 IP	HAND	PL.1	PL.2	SP2A	SP2B	d.SP	H. SC	Lo SC	INPE	UNIT			
MANUAL ADJUSTMENTS SP2 MODES RANGING CONFIGURE INPUT														
LEVEL 1	TUNE	BAND	ALTB	DETB	DAC	CYCLE	OFFSE	SP1L	SP1R	SP1R	SOAK	SET.2	BND.2	CYC.2
SP1 SETTINGS PROGRAMMER SETTINGS SP2 SETTINGS														
LEVEL C	ADDR	BAUD	DATA	DBUD										
COMMS SETTINGS														

Security lock *noneE: LEV 3; LEV 2: ALL*
 Disable program auto-exit *Auto: STAY*
 Disable -AL- alarm display *Off: on*
 Display averaging *dir: 1 to 32 (6)*
 Derivative sensitivity *0.1 to 1.0 x dEr:1 (0.5)*

SP1 output device *noneE: rIf; SSd **
 SP2 output device *noneE: SSd: rIf (read only) **
 Sensor burn-out *uP SC: dn SC; 1u.2d; 1d.2u*
 Reverse outputs *1r.2d; 1d.2d; 1r.2r; 1d.2r*
 Reverse O/P LEDs *1n.2n; 1l.2n; 1n.2l; 1l.2l*
 Span adjustment *0.0 to 25% sensor fis*
 Zero Adjustment *0.0 to 25% sensor full scale*
 Set Monitor *Off: on*
 Read Monitor *VAR: hi: lo deg*
 Read Tune Data *CtA; CtB; Ct1; Ct2; Ct3; Ct4; oS1; uS; oS2*
 Software version *Consult unit*
 RESET *noneE: ALL*

Read SP1 output % *0 to 100% read only*
 SP1 manual output % *0 to 100% proportional mode only*
 Limit SP1 output % *100 to 0%*
 Limit SP2 output % *100 to 0%*
 Main SP2 mode *noneE: dVhi; dVLo: bAnd; FS:hi; FS:Lo: Cool*
 Second SP2 mode *noneE: LICH; hold: Lt:ho; rLin*
 Display resolution *1 or 0.1 degree*
 Set scale maximum *0.0 sensor max to full scale*
 Set scale minimum *0.0 sensor min to full scale*
 Select input sensor *noneE*
 Select display units *noneE: oC; oF: bAr; PSI; Ph; rh; SET*

Autotune or Park *off: on; tune: Park; At:Sp*
 SP1 Prop band (gain)/hyst *0.1 deg to 25% sensor fis (10°C/18°F)*
 Integrate time (reset) *Off: 0.1 to 60 min (5 min)*
 Derivative time (rate) *Off: 1 to 200 sec (25 sec)*
 Derivative approach *0.5 to 5.0 x bAnd (1.5)*
 Cycle time or on/off *On:off: 0.1 to 81 sec (20 sec)*
 Offset (manual reset) *0 to 50% x bAnd (In.t = off)*
 Setpoint lock (SP1) *Off: on*
 Setpoint Ramp rate *0 to 9990 deg/hour*
 Ramp off/on *On: off: hold*
 Soak time *Off: 0 to 1440 min*
 Adjust SP2 setpoint *+/- sensor full scale or full scale*
 SP2 prop band/Gain/Hyst *0.1 deg to 100% sensor fis (2°C/3.6°F)*
 SP2 Cycle on/off *On:off: 0.1 to 81 sec*

Level C only visible when COMMS Option fitted
 Instrument address *0 to 255*
 Baud rate *1200; 2400; 4800; 9600; 19k2*
 Data format *18n1;18E1;18O1*
 Tx/Rx activity *Off: on*

Range of Adjustment shown in red under description. If applicable, factory settings shown in bold.
 * Note: Dual Relay and Dual SSd Output Options Models 3311/9311 and 3322/9322 have their outputs pre-configured. (see page 22)

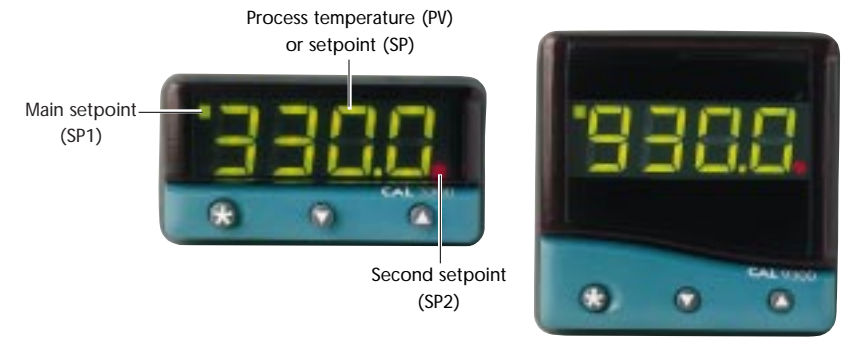

INSTRUMENT ADJUSTMENTS

- To enter or exit **program mode**: Press ▲ ▼ together for 3 seconds
- To scroll through **functions**: Press ▲ or ▼
- To change **levels or options**: Press ★ ▲ together or ★ ▼ together
- To view setpoint: Press ★
- To increase setpoint: Press ★ ▲ together
- To decrease setpoint: Press ★ ▼ together
- To reset an alarm or fault condition: Press ▲ ▼ together briefly

Notes: If in difficulty by becoming "lost" in program mode, press ▲ and ▼ together for 3 seconds to return to display mode, check the INSTRUMENT ADJUSTMENTS above and try again.

When in program mode, after 60 seconds of key inactivity the display will revert to either **INPE noneE** or, if the initial configuration has been completed, the measured value. Any settings already completed will be retained.

QUICK START

After power-up the controller requires programming with the following information:

Type of Sensor (See list of temperature sensors p.31)

Operating unit (See list of units p.18)

Allocation of Output Device to SP1/SP2 (Relay or SSd)

Temperature Setpoint eg. Degrees

When the above information has been programmed into the controller it will be operational with the following factory settings.

Proportional band/Gain	10°C/18°F
Integral time/Reset	5 mins
Derivative time/Rate	25 secs

Proportional cycle-time (Typical setting for relay output)	20 secs
DAC Derivative approach control (Average setting for minimum overshoot)	1.5

NB: Please note that in the manual, functions are reversed out from a black background and options are shown in bold italic;

eg. ***TURN*** and ***ParK***

Note: In this manual the letter k is represented by the character ***ƀ***

Note: During the following procedure the display will revert to alternating ***TURN*** and ***nonE*** after 60 seconds of key inactivity, but will retain any settings already completed. Should this occur, or in the event of becoming 'lost' in the program, please start again from the alternating ***TURN*** and ***nonE*** display.

QUICK START SET-UP

On power-up the controller will display the self test sequence followed by alternating ***TURN*** and ***nonE***

1 Select input sensor.

Press and hold ✖ and use the ▲ or ▼ buttons to scroll through the sensor selection list until the correct sensor is displayed. Release the buttons. The display now alternates selected sensor type (eg. ***TURN*** and ***Tc.S***)

Press ▲ **once** The display will now alternate ***TURN*** and ***nonE***

2 Select unit.

Press and hold **★** and use the **▲** or **▼** buttons to scroll through the unit selection list until the correct unit is displayed. Release the buttons. The display will now alternate selected unit (eg. **unit** and **°C**).

Press **▲** once The display will now alternate **SP 1.d** and **nonE**

3 Select SP1 (Main setpoint output device)

Note: Dual Relay and Dual Ssd Output Options Models 3311/9311 and 3322/9322 have their outputs pre-configured. (see page 22)

Press and hold **★** and use the **▲** or **▼** buttons to select **SSd** or **rLY** as required. The controller will now alternate selected output device (e.g. **SP 1.d** and **SSd**).

4 To enter initial configuration into controller memory

Press and hold both **▲** and **▼** buttons for 3 seconds. The display will now alternate **ParK** and measured variable (temperature) (eg. **23**) **ParK** is displayed because a setpoint has not yet been entered.

To display setpoint

Press and hold **★** The display will now alternate **0** and **unit** (eg. **°C**)

To enter setpoint

Press and hold **★** and use **▲** button to increase or **▼** button to decrease the reading and scroll to required setpoint value. (The digit roll-over rate increases with time).

THE CONTROLLER IS NOW OPERATIONAL WITH FACTORY SETTINGS

Note: For precise control of an application the controller may need to be TUNED. Please study section headed FUNCTIONS and OPTIONS before moving to the section on AUTOTUNE.

INTRODUCTION

THE CONTROLLERS



The CAL 3300 1/32 DIN and the CAL 9300 1/16 DIN miniature controllers share the same PID control strategy and features while giving the user the flexibility of a choice of panel format. Control can be optimised with a single shot autotune either on initial warm-up or at setpoint. A second setpoint can be configured in a variety of alarm modes or PID Heat-Cool strategy. A programmer offers a single ramp to setpoint with a choice of timed soak period before switching off the output.

Control of non temperature processes is achieved by the provision of linear input ranges and scaling in commonly used engineering units.

Serial communication is available as an option on both controllers, and the easy to use **CALCOMMS™** is a graphic

WINDOWS™ based software package designed for PC supervision of up to 32 instruments, for remote adjustment, configuration, cloning, saving and retrieving settings to files and logging and charting in real time.

CALCOMMS™ uses the MODBUS® protocol via either a fully isolated RS232 or RS485 link depending on the number of instruments and the transmission distances involved in the application.

A users manual is supplied with the comms option. For more information contact CAL. For details, see rear cover.

It is suggested that users read the **OVERVIEW** section of this manual before any installation or setting-up procedures are undertaken.

Note: The controller will not be operational until either the **QUICK-START** or **SET-UP** procedure has been completed.

NB: Please note that in the manual, functions are reversed out from a black background and options are shown in bold italic;

eg. ***TUNE*** and ***Park***

INSTALLATION

The Model 3300 controller is designed to be mounted in a 1/32 DIN panel cutout and the Model 9300 in a 1/16 DIN cutout. See the **INSTALLATION** section.

SET-UP

After installation the controller requires programming with the following information:

- Type of Input Sensor
- Operating unit (C or F etc)
- Type of Output Device
- Temperature Setpoint

Note: The controller will not be operational until this information is entered.

When the above information has been programmed into the controller it will be operational with the following factory PID (proportional band, integral time, derivative time) settings.

Proportional band/Gain	10°C/18°F
Integral time/Reset	5 mins
Proportional cycle-time	20 secs
Derivative time/Rate	25 secs
DAC Derivative approach control	1.5

AUTOTUNE

To precisely control an application the controller will need to be 'tuned' using the built-in '**AUTOTUNE**' feature. Autotune 'teaches' the controller the main characteristics of the process and 'learns' by cycling the output on and off. The results are measured and used to calculate optimum PID values which are automatically entered in the controller memory.

During **AUTOTUNE** the optimum cycle-time is calculated but is not automatically implemented. The cycle-time requires manual acceptance unless pre-selected.

To ensure good control over a wide range of applications two versions of the Autotune program are provided, **TUNE** and **TUNE AT SETPOINT**.

The **TUNE** method normally achieves the best results. Starting with the load cool, tuning occurs during warm-up preventing overshoot. This method of tuning is recommended.

The **TUNE AT SETPOINT** method is used for specialist applications. eg. Heat-cool, multizones and processes below 100°C/200°F. During the tuning cycle some overshoot occurs because the tuning cycle is at set point. The **DAC** setting is not re-calculated.

CYCLE-TIME

The choice of cycle-time is influenced by the external switching device or load. e.g. contactor, SSR, Valve. A setting that is too long for the process will cause oscillation and a setting that is too short will cause unnecessary wear to an electro-mechanical switching device.

Cycle-time selection methods

The following methods of cycle-time selection may be used:

Autotune calculated

After **Autotune** has been run and completed the calculated cycle-time can be manually accepted or adjusted to suit the switching device. For selection method see **Select Autotune Calculated Cycle-time**.

Pre-select autotune cycle-time

The controller can be programmed to automatically accept the calculated **Autotune** cycle-time. For selection method see **Pre-Select Automatic Acceptance of Any Autotune Cycle-time**.

Pre-select before autotune

The controller can be programmed manually with any cycle-time between 0.1 and 81 sec. This cycle-time will not be changed by any **Autotune** functions. For selection method see **Pre-Select Cycle-time Before Autotune**.

Factory set

To use the 20 sec factory set cycle-time no action is needed whether **Autotune** is used or not.

Further information can be programmed into the controller, see **SECOND SETPOINT, RANGING AND SETPOINT LOCK, IMPROVING CONTROL ACCURACY**

Functions and options

The facilities of the controller are selected from the multi-level menu using the front panel mounted buttons.

Note: It is advisable to study this section before any programming is undertaken.

Each level within the multi-level menu offers different functions, see **FUNCTIONS MENU** for menu of main functions. Each function has a range of user selections or options, see **FUNCTION LIST** for functions and options details.

Note: Please note that in the manual, functions are reversed out from a black background and options are shown in bold italic;
eg. **tune** and *ParK*

The controller has two modes, program mode and operating mode. When in program mode the controller can be programmed with settings and functions to suit the application. When in operating mode the controller uses the setting and functions entered in the program mode to control the application and also displays the process variable (temperature). For full details on how to program the controller see **VIEWING AND SELECTING FUNCTIONS**.

Note: In this manual the letter k is represented by the character **k**

This section details the four step initial configuration that enables control with factory PID settings to start, once the setpoint has been entered.

POWER-UP

On power-up the controller will display the self test sequence and brief display blanking and then alternately display **, rP E** and **nonE**

1 SELECT INPUT SENSOR

Press and hold ***** and use either the **▲** or **▼** buttons to scroll through the sensor selection (see table p.31). When the correct sensor is displayed, release the buttons. The controller will now alternately display selected sensor type **, rP E** and eg. **tc.S**

2 TO SELECT °C/°F

Press and release the **▲** button, the controller will now alternately display **u n, E** and **nonE**. Press and hold the ***** button and using the **▲** button select **°C**, **°F**, **Bar**, **PSI**, **Ph**, **Rh** or **SEt** as required. Release the buttons when the correct unit is displayed.

The controller will now alternately display selected range (eg. °C) and **unit**.

3 TO SELECT SP1 (Main setpoint output device)

Note: Dual Relay and Dual SSd Output Options
Models 3311/9311 and 3322/9322 have their outputs pre-configured. (see page 22)

Press and release the **▲** button, the controller will now alternately display **SP 1, d** and **nonE**. Press and hold the ***** button and using the **▲** button select **SSd** or **rLY** as required. Release the buttons when the correct device is displayed. The controller will now alternately display **SP 1, d** and selected output device (eg. **SSd**).

4 TO ENTER INITIAL CONFIGURATION INTO CONTROLLER MEMORY

Press and hold both **▲** and **▼** buttons for 3 seconds. The process temperature (e.g. **23°C**) and **ParK** will be alternately displayed as no setpoint has yet been selected.

TO SET THE MAIN SETPOINT

To display the setpoint, press and hold the ***** button. **°C** and **0** or **°F** and **32** will be alternately displayed. Press and hold the ***** button. Press **▲** to increase or **▼** to decrease the setpoint. The main setpoint LED will flash indicating that SP1 output is ON. The controller will now be set with the factory PID settings.

MENU NAVIGATION

The facilities of the controller are selected from the multi-level menu using the front panel mounted buttons. Each level within the multi-level menu offers different functions, see **FUNCTIONS MENU** for menu of main functions. Each function has a range of user select or input options, see **FUNCTION LIST** for functions and options details.

The controller has two modes, program mode and operating mode. When in program mode the controller can be programmed with settings and functions to suit the application. When in operating mode the controller uses the setting and functions entered in the program mode to control the application.

USING PROGRAM MODE

Note: The controller will auto-exit program mode after 60 seconds of inactivity.

To enter program mode from normal operating mode

Press and hold both ▲ and ▼ buttons for at least 3 seconds.

Release the buttons together when the function **tUNE** is displayed, this is the program entry point.

The controller will now alternately display the function and option (setting of that function), e.g. **tUNE** and **oFF**.

To view function on the same level

Press ▲ or ▼ button once to view the next function.

Press and hold ▲ or ▼ buttons to scroll through functions.

To display the current option or value for a function

On release of ▲ or ▼ buttons, option alternates with the function.

To change an option value or setting

Press and hold the ✱ button, then press ▲ to increase or ▼ to decrease the value or select the next option.

Note: Check the new option value before moving to another function or exiting program mode.

To change levels

Press and hold ▼ to scroll through the functions until **LEUL** is displayed. Release ▼ to display current level. Press and hold the ✱ button, then press ▲ to increase or ▼ to decrease the level. Release buttons when required level is obtained.

To exit program mode

Press and hold both ▲ and ▼ buttons for at least 3 seconds.

Note: Control commences with any new instructions now entered in the memory.

REMINDER OF INSTRUMENT ADJUSTMENTS

Press ▲ ▼ together for 3 seconds for program entry or exit.

Press ▲ or ▼ to scroll through functions.

Press ✱ ▲ together or ✱ ▼ together to change levels or alter options.

Note: If in difficulty by becoming "lost" in program mode, press ▲ and ▼ together for 3 seconds to return to display mode, check the Menu Navigation summary above and try again.

AUTOTUNE

Select the most appropriate method of Autotune , Tune or Tune at Setpoint, to suit the application.

Note: The proportional cycle-time can be pre-selected before starting Autotune, see **PROPORTIONAL CYCLE-TIME**.

The **TUNE** program should be run with the load cool. The output is cycled at 75% of the setpoint value to avoid any overshoot during the tuning cycle. The warm-up characteristics are monitored and set DAC which minimises overshoot on subsequent warm-ups.

The **TUNE AT SETPOINT** program is recommended:

when the setpoint is below 100°C/200°F, where TUNE's tuning cycle at 75% setpoint may be too close to ambient to produce good results;

when the process is already hot and the cooling rate is slow;

when controlling multi-zone or heat-cool applications;

to re-tune if the setpoint is changed substantially from previous Autotune.

Note: dAC is not re-tuned by **TUNE AT SETPOINT**.

TUNE PROGRAM

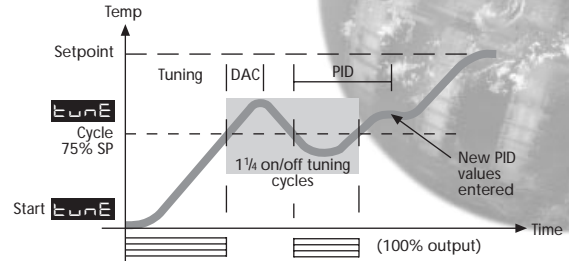

Enter program mode and select **TUNE**

The controller will alternately display **TUNE** and **oFF**.

Press and hold **★** and press **▲** once,

The controller will alternately display **TUNE** and **on**.

Exit program mode.

The **TUNE** program will now start. The controller will alternately display **TUNE** and the process temperature as it climbs to setpoint.

Note: During tuning, the main setpoint (SP1) LED will flash.

When the **TUNE** program is complete the alternating display stops and the process temperature is displayed. The PID values are entered automatically. The process temperature will rise to setpoint and control should be stable. If not, this may be because optimum cycle time is not automatically implemented. To set the cycle time see **PROPORTIONAL CYCLE-TIME**.

TUNE AT SETPOINT PROGRAM

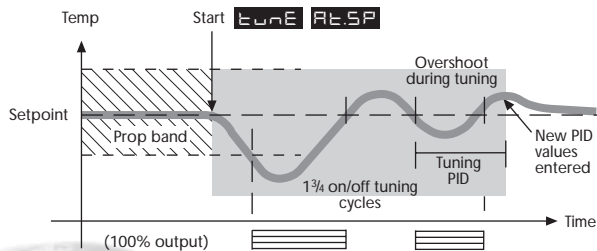

Enter program mode and select **tUNE**

The controller will alternately display **tUNE** and **OFF**.

Select **tUNE At.SP**.

The controller will alternately display **tUNE** and **At.SP**.

Exit program mode.

The **TUNE AT SETPOINT** program will now start. The controller will alternately display **tUNE** and the process temperature.

Note: During tuning the main setpoint (SP1) LED will flash.

When the **TUNE AT SETPOINT** program is complete the alternating display stops and the process temperature is displayed. The PID values are entered automatically. The process temperature will rise to setpoint and control should be stable. If not, this may be because optimum cycle time is not automatically implemented. To set the cycle time see **PROPORTIONAL CYCLE-TIME**.

REMINDER OF INSTRUMENT ADJUSTMENTS

Press **▲ ▼** together for 3 seconds for program entry or exit.

Press **▲** or **▼** to scroll through functions.

Press **★ ▲** together or **★ ▼** together to change levels or alter options.

Note: If in difficulty by becoming "lost" in program mode, press **▲** and **▼** together for 3 seconds to return to display mode, check the Menu Navigation summary above and try again.

PROPORTIONAL CYCLE-TIME

The choice of cycle-time is influenced by the external switching device or load. eg. contactor, SSR, valve. A setting that is too long for the process will cause oscillation and a setting that is too short will cause unnecessary wear to an electro-mechanical switching device.

CYCLE-TIME SELECTION METHODS

The following methods of cycle-time selection may be used:

Autotune calculated

After Autotune has been run and completed the calculated cycle-time can be manually accepted or adjusted to suit the switching device. For selection method see **Select Autotune Calculated Cycle-time**.

Pre-select Autotune cycle-time

The controller can be programmed to automatically accept any calculated Autotune cycle-time. For selection method see **Pre-Select Automatic Acceptance of Any Autotune Cycle-time**, page 10.

Pre-select before Autotune

The controller can be programmed manually with any cycle-time between 0.1 and 81 sec. This cycle-time will not be changed by any Autotune functions. For selection method see **Pre-Select Cycle-time Before Autotune**, page 10.

Factory set

To use the 20 sec factory set cycle-time no action is needed whether autotune is used or not.

CYCLE-TIME RECOMMENDATIONS

Output Device	Factory Setting	Recommended Minimum	Load max (resistive)
Internal relay rLY/rLY1	20 seconds	10 seconds	2A/250 Vac
Internal relay rLY2	20 seconds	10 seconds	1A/250 Vac
Solid state drives SSd/SSd1/SSd2	20 seconds	0.1 seconds	Externally fitted SSR (n/a)

To Select AUTOTUNE CALCULATED CYCLE-TIME

On completion of Autotune enter program mode.

Select **CYCLE**

The controller will now alternately display **CYCLE** and **20** (the factory setting).

To view the calculated optimum cycle-time press and hold the **★** button then press and hold **▼** until indexing stops. The controller will display the calculated cycle-time **CYCLE** and eg. **A 16**. This indicates that the calculated cycle-time is 16 seconds.

Proportional Cycle-time (continued)

If this cycle-time is suitable press and hold both ▲ and ▼ buttons for 3 seconds to enter it into the controllers memory.

If the calculated cycle-time is not compatible with the switching device press and hold the ✱ button then press and hold ▲ or ▼ until a more suitable cycle-time is displayed. Release the buttons, then press and hold both ▲ and ▼ buttons for 3 seconds to enter it into the controllers memory.

Pre-Select Automatic Acceptance of Any Autotune Cycle-time

Before selecting Autotune, enter program mode.

Select **CYCLE**

Press and hold the ✱ button then press and hold ▼ until indexing stops and A -- is displayed.

Note: A -- indicates that no cycle-time exists.

Press and hold ▼ to scroll to **TUNE**
The controller will now alternately display **TUNE** and **OFF**. Press and hold the ✱ button and use ▲ to select either **on** or **At.SP**. Release ▲.

The controller will now run Autotune and will accept the calculated cycle-time.

To Pre-Select Cycle-time Before Autotune

Before selecting Autotune, enter program mode.

Select **CYCLE**

Press and hold the ✱ button, then press ▲ to increase or ▼ to decrease the displayed cycle-time. Release buttons when required value is displayed.

Select **TUNE** or index to another function then exit program mode.

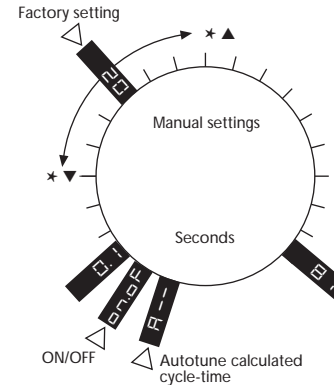

PROGRAMMER

RAMP-SOAK

This feature enables the controller to ramp up or down from current temperature to a target setpoint at a pre-determined rate. It then controls at the target setpoint for an adjustable soak period before switching off the heat output.

Set **Ramp rate** (0 to 9995 deg/hour)

Press ▲ and ▼ buttons for 3 seconds to enter program entry point **tune**

Press ▲ to scroll to **SPrr**

Press and hold ✱, then press ▲ or ▼ to scroll to required value.

Set **Soak** (if required) 0 to 1440 minutes

Press ▲ to scroll to **Soak**

Press and hold ✱, then press ▲ or ▼ to scroll to required soak period.

Set **Ramp On** (Off) : On : hold

Press ▲ to scroll to **SPrr**

Press and hold ✱, then press ▲ to select **On**

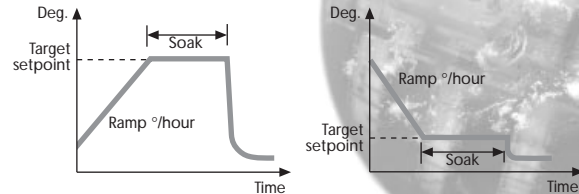

Exit program to enter settings into memory and commence ramp to target setpoint.

Notes

In **Ramp on** configuration, if power is removed from the controller, the Ramp will re-start when power is restored.

The **Ramp hold** option suspends the ramp at its last value.

If no **Soak** period has been set, control at target setpoint continues indefinitely.

SP2 deviation alarms follow the ramp setpoint and can be used to alarm "out of limits" ramp rate.

WARNING

The Soak timer is triggered when the ramp setpoint reaches the target setpoint. If the ramp rate is set too fast for the process, the Soak timer will be triggered before the process temperature reaches the target setpoint.

SECOND SETPOINT (SP2)

The second setpoint SP2 can be used to trigger an alarm or as a proportional control output.

TO CONFIGURE SP2 AS AN ALARM

Enter program mode.

Select level 2 then **SP2.A**, followed by the required option below:

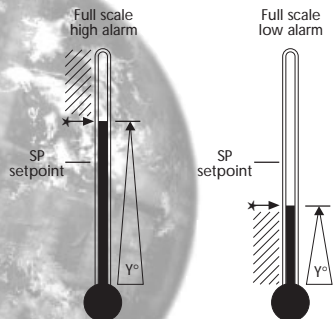
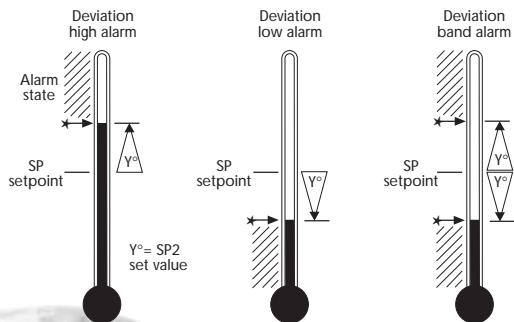

- dV.hi** sets off alarm signal when temperature rises above a pre-set temperature above the setpoint.
- dV.Lo** sets off alarm signal when temperature falls below a pre-set temperature below the setpoint.
- bAnd** sets off alarm signal when temperature rises above or falls below a pre-set temperature above or below the setpoint.
- FS.hi** sets off alarm signal when the temperature rises above setpoint to a pre-set temperature above scale minimum.
- FS.Lo** sets off alarm signal when the temperature falls below setpoint to a pre-set temperature above scale minimum.

Select level 1 and select **SET.2** and set the required setpoint value (y°).

If the factory set hysteresis 2.0°C/3.6°F is unsuitable:

Index to **bnd.2** and adjust the setting.

Check **CYC.2** is set to **on.oF** (for alarm).

Exit program mode. SP2 is now operational as an alarm.

Cool see heat-cool configuration, page 23.

SUBSIDIARY SP2 MODE: **SP2.b** Latch/sequence or non-linear cool.

Latch alarm **LtCh**

When activated, the alarm latches until manually reset, even though the alarm condition may have disappeared.

Sequence alarm **hoLd**

When **hoLd** is selected, in any alarm mode, it prevents an alarm signal on power-up. The alarm is enabled only when the process temperature reaches setpoint.

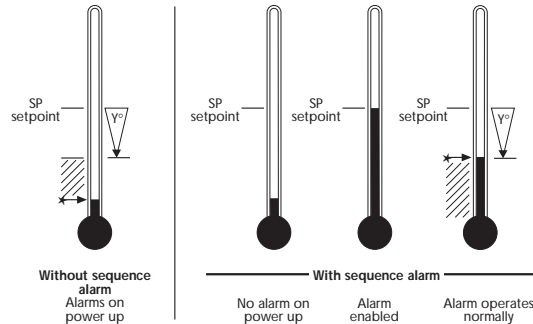

TO CONFIGURE SP2 AS A PROPORTIONAL CONTROL OUTPUT

In level 2 select **SP2.A**, then select the required option.

In level 1 select **band.2** and then set the required proportional band.

In level 1 select **SEt.2** and then set the setpoint (SP2) value (y°).

SP2 OUTPUT AND LED INDICATION STATES - IN ALARM CONDITION

Alarm type	ON-OFF operating mode		Proportional operating mode	
Deviation du.h du.Lo band	SP2 Output state 	SP2 LED state 	SP2 Output state 	SP2 LED state
Full scale F.S.h F.S.Lo				
Cool Strategy	Temperature above setpoint			

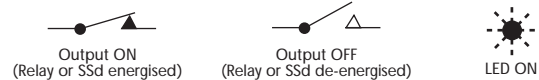

SP2 ALARM ANNUNCIATOR

When an SP2 alarm mode is selected in SP2.A the alarm annunciator **-AL-** is displayed, alternating with the process temperature, during alarm condition.

Note: The annunciator may be disabled by selecting function **no.AL**, option **on** in level 4.

SP2 in cool strategy

(See heat-cool configuration in **ADVANCED SETTINGS** page 23).

ERROR MESSAGES

SENSOR FAULT

Display flashing: **TEMP** and *Fail*

Indicates: thermocouple burnout RTD/Pt100 open or short circuit or negative over-range.

Action: Check sensor/wiring

NON-VOLATILE MEMORY ERROR

Display flashing: **DATA** and *Fail*

Action: De-power briefly. Replace unit if problem persists

MANUAL POWER ERROR

Display flashing: **DATA** and *Fail*
SP1 set to ON/OFF in **CYC.t**

Action: Select proportional mode

IMMEDIATE FAIL ON AUTOTUNE START

Display flashing: (setpoint), **TUNE** and *Fail*
1. No setpoint entered

Action: Enter setpoint

2. SP1 set to ON/OFF in **CYCLE**

Action: Select proportional mode

Note: To reset and clear error press **▲▼** together briefly to cancel message.

FAIL LATER DURING AUTOTUNE CYCLE

The thermal characteristics of the load exceed the Autotune algorithm limits. The failure point indicated by any display

0.0 in **EECH** eg. Ctb = 0.0 see diagram below.

- Action:
1. Change the conditions. eg. raise setpoint
 2. Try **TUNE At.SP**
 3. Check SP1.P percentage power (see **IMPROVING CONTROL ACCURACY**)
 4. If the error message persists, call CAL for advice.

READING AUTOTUNE TUNING CYCLE RESULTS IN **EECH**

1. Index to **EECH**, release **▲** or **▼**, display will alternately display **EECH** and **Ct.A**
2. Press and hold **★**, the display will alternate **Ct.A** and value (eg. 10.4)
3. Keep **★** pressed and press **▲** once, the display **Ct.B** and value (eg. 19.6)
4. Repeat step 3 above to view: **Ct 1, Ct 2, Ct 3, Ct 4, oS 1, uS** and **oS 2**.

Autotune tuning data and limits

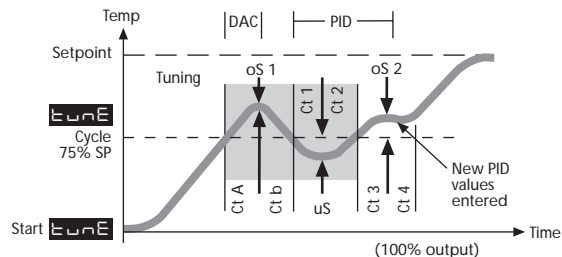

IMPROVING CONTROL ACCURACY

The following functions are to assist engineers with machine development, commissioning and troubleshooting.

SP 1.P READ SP1 OUTPUT PERCENTAGE POWER

Poor control may be due to incorrectly sized heaters.

SP 1.P (Level 2) constantly displays the output percentage power applied, which at normal setpoint should ideally be within 20 - 80% to achieve stable control.

CH EE CONTROL ACCURACY MONITOR

This measures the control stability, to within 0.1 °C/°F.

The monitor is started using **CH EE** (Level 3) and the variance (deviation), maximum and minimum temperatures are displayed and constantly updated in **READ**

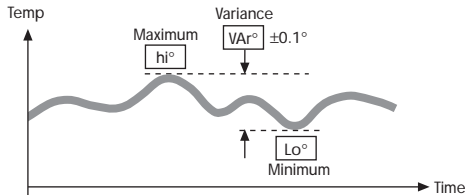

Using the **CH EE** Control accuracy monitor

To start the monitor select **CH EE on**

Note: During monitoring either return to normal operation or remain in program mode.

To view monitor readings: index to **READ**

The display will alternate between **READ** and **Var°**

Press and hold **★**, the display will alternate between **Var°** and the variance displayed in degrees (e.g. 0.6)

Press and hold **★** and press **▲** once, the display will alternate between **Var°** and the maximum **hi°** displayed in degrees (e.g. 320.3)

Press and hold **★** and press **▲** once, the display will alternate between **Var°** and the minimum **Lo°** displayed in degrees (e.g. 319.7)

CH EE OFF stops monitor retaining readings

CH EE on resets readings.

On de-powering **CH EE** resets to **OFF** and **READ** is zeroed.

FUNCTION LIST

The functions and options are available in four levels.

Note: A Functions Menu is shown on the cover fold-out

LEVEL 1

Function Options [Factory settings] shown in brackets

SELECT AUTOTUNE

tune [oFF] on *ParK At.Sp*

Used to switch the Autotune feature on and off, to select *ParK* or Autotune at setpoint.

ParK temporarily turns the output(s) off. To use select *ParK* and exit program mode. To disable re-enter program at

tune and select *oFF*.

SP1 OPERATING PARAMETERS

bAnd 0.1 to * °C/°F [10°C/18°F]

SP1 proportional band/Gain or Hysteresis

* 25% sensor maximum

Proportional control eliminates the cycling of on-off control. Heater power is reduced, by time proportioning action, across the proportional band.



Too narrow
(oscillates)

increase **bAnd**

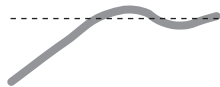

Too wide
(slow warm up and response)

decrease **bAnd**

intE oFF 0.1 to 60 minutes [5.0]

SP1 integral time/reset

Auto-corrects proportional control offset error



Too short
(overshoots and oscillates)



Too long
(slow warm up and response)

derE oFF 1 - 200 seconds [25]

SP1 derivate time/rate

Suppresses overshoot and speeds response to disturbances



Too short
(slow warm up and response,
under corrects)



Too long
(oscillates and over corrects)

dAC 0.5 - 5.0 x bAnd [1.5]

SP1 derivative approach control dAC

Tunes warm-up characteristics, independent of normal operating conditions, by controlling when derivative action starts during warm-up (smaller dAC value = nearer setpoint).



Too small
(overshoots)



Too large
(slow stepped warm up)

LEVEL 1 (continued)

CYC.1 A -- on.oF 0.1 - 81 sec [20]

SP1 proportional cycle-time (see pages 9/10)

Determines the cycle rate of the output device for proportional control. Select **on.oF** for ON/OFF mode.

oFSE [0] to * °C/°F

SP1 offset/manual reset

* ±50% **bAnd**. Applicable in proportional and ON/OFF mode with integral disable: **Int.t oFF**.

SP.LY [oFF] on

Lock main setpoint

Locks the setpoint preventing unauthorised adjustment.

PROGRAMMER SETTINGS (see page 11)

SP.r.r [0] to 9995 deg/hour

Sets the ramp rate

SP.r.n on [oFF] hoLd

Switches the ramp on or off, or hold at last ramp value

SoAK [oFF] 0 to 1440 min

Sets the soak time

SP2 OPERATING PARAMETERS (see pages 12/13)

SEt.2 0 to * °C/°F [0]

Adjust SP2 setpoint

* Deviation Alarms **DV.hi**, **DV.Lo**, **bAnd**
25% sensor maximum (see figure 7).

* Full scale alarms **FS.hi**, **FS.Lo**
sensor range f/s (see figure 8)

band.2 0.1 - * °C/°F [2.0 °C/3.6 °F]

Adjust SP2 hysteresis or proportional band/gain
(see **CyC.2** setting)

* 25% sensor f/s

CYC.2 [on.oFF] 0.1–81 seconds

Select SP2 ON/OFF or proportional cycle-time

Select on.oFF for ON/OFF mode, or the cycle rate of SP2 output device for proportional mode.

LEVEL 2

MANUAL CONTROL MODES

SP1P 0 to 100 % 'read only'

Read SP1 output percentage power

HARD [oFF] 1 to 100 % (not in ON/OFF)

SP1 manual percentage power control

For manual control should a sensor fail.

Record typical *SP1.P* values beforehand.

PL1 100 to 0 % duty cycle [100]

Set SP1 power limit percentage

Limits maximum SP1 heating power during warm-up and in proportional band.

PL2 100 to 0 % duty cycle [100]

Set SP2 percentage power limit (cooling)

SP2 OPERATING MODES (see page 12/13)

SP2A [nonE] dV.hi dV.Lo bAnd
FS.hi FS.Lo Cool

Main SP2 operating mode

SP2b [nonE] LtCh hoLd nLin

Subsidiary SP2 mode: latch/sequence

Non-linear cool proportional band

INPUT SELECTION AND RANGING

d, SP [1] 0.1

Select display resolution: for display of process temperature, setpoint, *OFSt*, *Set.2*, *hi.SC*, *LoSC*.

h, SC sensor minimum [sensor maximum]
°C/°F

Set full scale

LoSC [sensor minimum] sensor maximum
°C/°F

Set scale minimum (default 0°C or 32°F)

, nPt Select input sensor [nonE]
(See **SENSOR SELECTION** table, page 31)

uniE nonE °C °F bAr Psi Ph rh SET
Select °C/°F or process units

LEVEL 3

OUTPUT CONFIGURATION

Note: 'Read only' after initial configuration. **rSET ALL** full reset to factory settings required to change **SP 1.d** subsequently.

SP 1.d [nonE] rLY SSd rLY1 rLY2 SSd1
Select SP1 output device

SP 2.d [nonE] SSd rLY rLY2 rLY1 SSd2
Read SP2 output device
(read only)

Dual Relay and Dual SSd output options Models 3311 and 3322 are factory set. See page 22

Note: (when in initial configuration only)

Hold **★** and **▲** or **▼** for 10 seconds to move to or from output devices in shaded portion.

burn

Sensor burn-out/break protection

Caution: Settings affect fail safe state.

	SP1	SP2
[uP.SC]	Upscale	Upscale
dn.SC	Downscale	Downscale
1u.2d	Upscale	Downscale
1d.2u	Downscale	Upscale

rE u.d

Select output modes: Direct/Reverse

Caution: Settings affect fail safe state.

	SP1	SP2
[1r.2d]	Reverse	Direct
1d.2d	Direct	Direct
1r.2r	Reverse	Reverse
1d.2r	Direct	Reverse

Select **Reverse** on SP1 for heating and **Direct** for cooling applications.

LEVEL 3 (continued)

FEUL

Select SP1/2 LED indicator modes

	SP1	SP2
<i>[1n.2n]</i>	Normal	Normal
<i>1i.2n</i>	Invert	Normal
<i>1n.2i</i>	Normal	Invert
<i>1i.2i</i>	Invert	Invert

SPAN*[0.0]* to $\pm 25\%$ sensor maximum

Sensor span adjust

For recalibrating to a remote standard e.g. External Meter, data logger. See **ADVANCED SETTINGS** page 24,25.

ZER0*[0.0]* to $\pm 25\%$ sensor f/s

Zero sensor error, see SPAN

CHER*[oFF]* on

Select control accuracy monitor

FEAD*[Var]* hi Lo

Read control accuracy monitor

EECH*[Ct A] CT b Ct 1 Ct 2 Ct 3
Ct 4 oS 1 uS oS 2*

Read Autotune tuning cycle data (see figure, page 14)

VER

Software version number

RESET*[nonE]* ALL

Resets all functions to factory settings

Caution: Note current configuration before using this function, otherwise initial configuration and OEM settings must be re-entered.

LEVEL 4

Access to level 4 is gained through **VER** in level 3. Press and hold ▲ and ▼ for 10 seconds.

Enter level 4 at **Lock**, release ▲ and ▼ together. Display will alternate **LoCK** and **nonE**

Program security using Lock

Select from three **Lock** options:

Press and hold ✱, press ▲ to index.

- LEV.3** locks level 3 and 4 only- Technical Functions.
- LEV.2** locks levels 2, 3 and 4 only - Configuration and Technical Functions.
- ALL** locks all functions (unrestricted **LEVL**, **VEr**, **TECH**, **SPLK**)

Note: Locked functions and options may be read.

Press ▼ to access following functions

Prog [Auto] **StAY**

Program mode auto-exit switch
Auto-exit returns display to normal if 60 seconds of key inactivity, select **StAY** to disable

no.AL [oFF] **on**

Disable SP2 alarm annunciator -AL-
Select on to disable -AL-

d.SS **dir** 1 to 32 [6]

Display sensitivity
dir = direct display of input
1 = maximum, **32** = minimum sensitivity

DER.S 0.1 to 1.0 [0.5]

Derivative sensitivity



IMPORTANT NOTE FOR OEM's: For safety and to protect settings from tampering USE THE SOFTWARE SECURITY LOCK.... THEN REMOVE THIS SECTION.

FACTORY SET OUTPUT OPTIONS

DUAL RELAY OR DUAL SSd OUTPUT MODELS

The table below details the factory set output options. rLY2 is a 1A electromechanical relay, and SSd1/SSd2 is an identical second SSR drive output.

Product Code	Terminals			
	3	4	5	6
3311/9311	rLY1 (2A)		rLY2 (1A)	
3322/9322	SSd1 (+) (-)		SSd2 (+) (-)	

QUICK START (page 1a) or **SET-UP** (page 5) follow steps 1 and 2 ignore step 3 and proceed straight to step 4.

Factory Options 3311/9311 and 3322/9322 pre-allocate SP1 to terminals 3 and 4.

Note: Output device rLY/rLY1 is rated 2A
Output device rLY2 is rated 1A

Factory Option 3311/9311 offers the ability to change the allocation of SP1 to terminals 5 and 6.

To make this selection during the initial configuration in either QUICK START (page 1b) or SET-UP (page 5), start from step 3.

3 TO SELECT SP1 (Main setpoint output device)

From the alternating display **SP 1d** and **rLY1** press and hold **★** button then press the **▲** once to display **rLY2**.

ADVANCED SETTINGS

Before embarking on the Advanced Settings, please familiarise yourself with the basic operation of the controller as described in this manual. The following instructions assume that the user understands how to make the initial configuration, can navigate through the Function Menu and successfully Autotune the controller in heating mode.

HEAT COOL STRATEGY CONFIGURATION

Using **SP2.A** *Cool* option

Heat-Cool strategy is a feature that improves control of processes that need heating and cooling, depending on the conditions, for example:

Environmental test chambers used in rooms where the ambient temperature swings above and below the test temperature.

Plastics extruders where the material initially needs heating, then cooling, when it begins to heat itself exothermically due to pressure and friction applied by the process.

The purpose of cool strategy is to maintain smooth control of the process during transition from heating to cooling. This is achieved by using PID control for heating and cooling with the proportioning bands linked by an adjustable deadband.

From cold (normal procedure on a new installation)

Enter setpoint and allow the process to reach the setpoint using factory settings for **heating only**.

Autotune at setpoint

Make the following pre-settings:

Level 1 set **DAE** to **1.0** **CYC.t** to **10**
and **CYC.2** to **10**

Level 2 set **SP2.A** to **Cool**

Level 1 set **tUNE** to **At.SP**

Autotune will cause a temporary disturbance. Check that the temperature has stabilised in **heating** mode before running the process in cooling mode.

If regular temperature oscillations occur, change **CYC.t** to optimum value. See page 9. **To select Autotune Calculated Cycle-time**

Further adjustments – Cooling

Autotune uses the same calculated **band** value for both **SP1** (heating) and **SP2** (cooling). In some processes, regular temperature oscillations occur when cooling.

Make the following manual adjustment:

In level 1 double the value of **band.2**

Heat Cool Strategy Configuration (continued)

If no improvement, return to the original value and;

In level 1 halve the value of **CYC.2**

If the process hunts between heating and cooling, a deadband setting may be needed. Enter a small value, eg. 1 and observe the process. Increase the setting until hunting stops.

Level 1 adjust value **SEt.2**

Water cooled applications

Water cooled applications operating at temperatures greater than 100°C may suffer from the non linear effect caused by water turning to steam. This can be countered by the non linear setting for SP2;

In level 2 set **SP2.6** to *nL in*

Multi zone applications

When tuning multi zone applications like extruders, distortions due to thermal interaction between adjacent zones can be minimised by running autotune on all controllers at the same time.

CALIBRATION TO ANOTHER INSTRUMENT

If the controller and instrument readings are different, the **ZERO** and/or **SPAN** function in Function Menu Level 3 will require adjustment.

Adjust **ZERO** to make an equal adjustment across the full scale of the controller and **SPAN** to make a correction when the error increases/decreases across the scale.

1 To adjust using the **ZERO** function

1.1 Substitute measured values in the expression:

$$\text{Instrument reading} - \text{controller reading} = \mathbf{ZERO}$$

Example:

$$\begin{aligned} \text{Instrument reading} &= 396^\circ \\ \text{Controller reading} &= 400^\circ \\ 396 - 400 &= (-)4^\circ \end{aligned}$$

1.2 Adjust **ZERO** to (-) 4° to correct error.

To make a correction when there are different errors across the scale.

Calibration to Another Instrument (continued)

- 2 Adjust using the **SPAN** function
 - 2.1 Chose a temperature near the bottom and another near the top of the scale.
 - 2.2 Run the process at the lower temperature (T_1). Note the error (E_1) between the controller and the instrument readings.
 - 2.3 Repeat at the upper temperature (T_2) and note error (E_2).
 - 2.4 Substitute the values for T_1 , T_2 , E_1 and E_2 in the expression below to calculate **SPAN**

$$\frac{E_2 - E_1 \times hi.SC}{T_2 - T_1} = SPAN$$

For **hi.SC** settings see level 2.

Example:	T_1	T_2
Instrument reading	58°	385°
Controller reading	60°	400°
Error	$E_1(-) 2^\circ$	$E_2 (-) 15^\circ$

$$\frac{(-15) - (-2) \times 450}{385 - 58} = \frac{(-13) \times 450}{327} = (-)17.9$$

- 2.5 Therefore adjust **SPAN** to (-) 18 to correct error.

- Notes:** (1) After making the adjustment the reading will immediately change. Allow time for the temperature to stabilise at T_2 before making any further adjustment. At this point, a **ZERO** adjustment may be needed, refer to step 1 above.
- (2) Check that the temperature correctly stabilises at T_2 and then adjust setpoints to T_1 . If an error is present at T_1 repeat from step 2.

LINEAR INPUT CALIBRATION

In addition to the ten temperature inputs, the controller has five linear input ranges which can be calibrated to display a range of engineering units. This procedure involves making adjustments to the controller's **hi.SC**, **ZERO** and **SPAN** adjustments found in function menu levels 2 and 3.

Note: The controllers linear inputs are in mV. If your transducer provides an output in mA this should be converted to mV by feeding the controller input via a high stability one ohm resistor, see figure page 26. Other low Vdc signals can be connected via a suitable voltage divider network to match the controller input requirements.

Linear Input Calibration (continued)

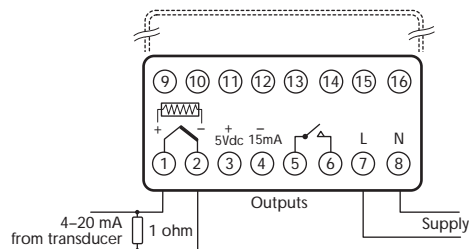

- 1 Power up the controller, and in response to the prompt **LINE** *none* select an appropriate Linear Range from the table below.

Ensure that the Nominal Signal Span chosen is wider than the transducer's actual signal span, and the Nominal Scale is wider than the full scale of the engineering units to be displayed.

Linear Range	Nom. Signal Span	Nom. Scale Span	Max. Scale Settings
Lin 1	0-20 mV	0 - 100	0 - 400
Lin 2	4-20 mV	0 - 100	-25 to 400
Lin 3	0-20 mV	0 -1000	0 to 3000
Lin 4	4-20 mV	0 - 1000	-250 to 3000
Lin 5	0-20 mV	0 - 2000	0 to 3000

- 2 Select **UNIT**, then select the process unit, **°C**, **°F**, **Bar**, **PSI**, **Ph**, or **rh**. If the required unit is not shown select **Set**.

- 3 Allocate the output devices at function **SP1.d** as described in **SET-UP**, enter the configuration into the memory and proceed as follows:

Calculate the values for the controller settings for **hi.SC** and **SPAN** using the example below as a guide:

4 to 7mV input from transducer is required to display 0 - 110 units

Chose Linear Range Lin4 4-20mV = 0 to 1000 units.

$$\mathbf{hi.SC} = \frac{\text{Nominal Signal Span}}{\text{actual signal span}}$$

$$\frac{(20-4)}{(7-4)} \times (110-0) = 587$$

$$\mathbf{SPAN} = \frac{(\mathbf{hi.SC} - \text{nominal scale span}) \times \mathbf{hi.SC}}{\text{Nominal Scale Span}}$$

$$\frac{(587-1000) \times 587}{1000} = -242$$

These settings should provide the correct scaling adjustment, but a value for **ZERO** may need to be established by applying the lowest and highest mV input signal and recording the display offset. Check that this is the same at each end, and enter this plus or minus value as a **ZERO** adjustment. Should there be a difference between the two readings, a further adjustment of the **SPAN** setting can be made.

MECHANICAL INSTALLATION

The 3300 Controller is designed to be mounted in a 1/32 DIN panel cutout and the 9300 Controller in a 1/16 DIN cutout. The only differences between the two instruments are their vertical dimensions.

Both models are sleeve mounted with their front bezel assembly rated NEMA4/IP66 provided that:

- the panel is smooth and the panel cutout is accurate;
- the mounting instructions are carefully followed.

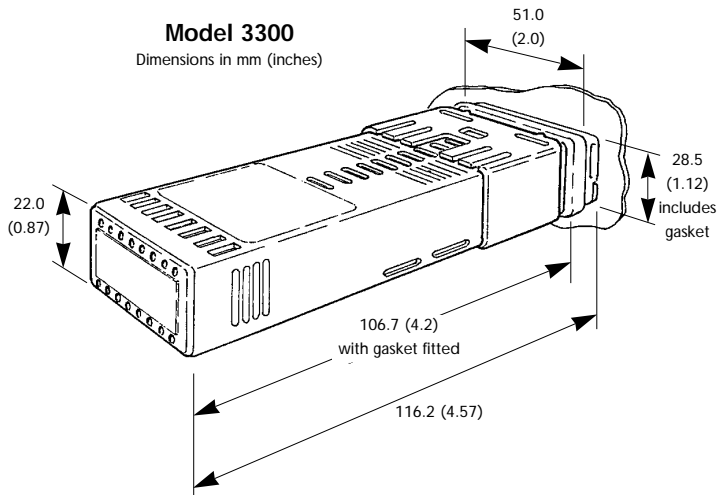

DIN PANEL CUTOUT SIZES

1/32 DIN panel cutout size

45.0mm +0.6mm -0.0mm (1.77in. +0.02in. -0.0in.) wide
22.2mm +0.3mm -0.0mm (0.87in. +0.01in. -0.0in.) high
9.5mm (0.374in) maximum panel thickness.

1/16 DIN panel cutout size

45.0mm +0.6mm -0.0mm (1.77in. +0.02in. -0.0in.) wide
45.0mm +0.6mm -0.0mm (1.77in. +0.02in. -0.0in.) wide
9.5mm (0.374in) maximum panel thickness.

MINIMUM SPACING

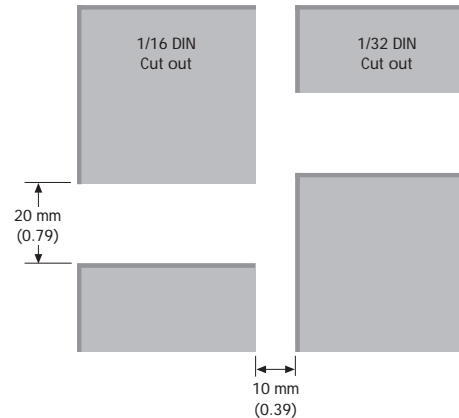

MOUNTING

To mount a Controller proceed as follows:

- 1 Check that the controller is correctly orientated and then slide the unit into the cutout.
- 2 Slide the panel clamp over the controller sleeve pressing it firmly against the panel until the controller is held firmly.
- 3 The controller front bezel and circuit board assembly can be unplugged from the sleeve. Grasp the bezel firmly by the recesses on each side and pull. A screwdriver can be used as a lever if required.
- 4 When refitting the bezel assembly it is important to press it firmly into the sleeve until the latch clicks in order to compress the gasket and seal to NEMA4X/IP66.

Cleaning

Wipe down with damp cloth (water only)

Model 9300
Dimensions in mm (inches)

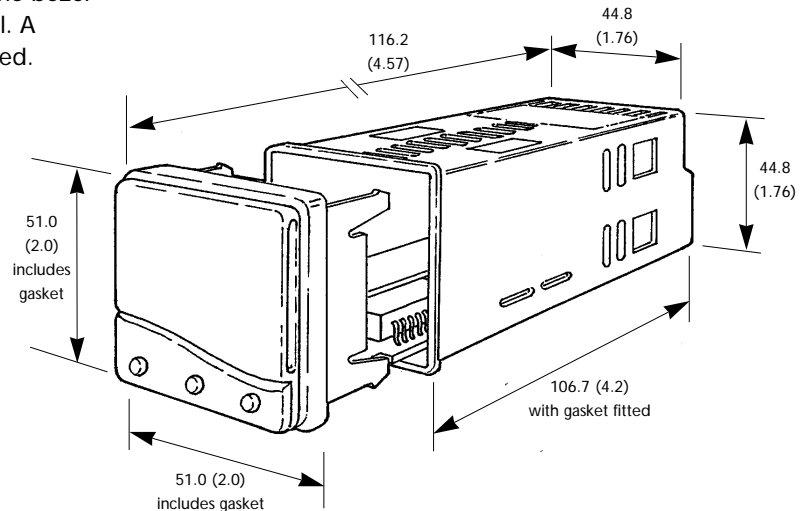

Note: The controller should be isolated before removing or refitting it in the sleeve, and electrostatic precautions should be observed when handling the controller outside the sleeve.

ELECTRICAL INSTALLATION

OUTPUT DEVICES

Two of the following output devices are fitted to the controllers, depending on the model.

- 1 Solid state relay drive (SSd/SSd1/SSd2)**
5Vdc +0/-15%, 15mA non isolating
To switch a remote SSR (or logic)
- 2 Miniature power relay (rLY/rLY1)**
2A/250V resistive, Form A/SPST contacts.
- 3 Sub miniature power relay (rLY2)**
1A/250V resistive, Form A/SPST contacts.

OUTPUT DEVICE ALLOCATION

Either of the available outputs may be chosen for the main setpoint (SP1), the remaining device being automatically allocated to the second setpoint (SP2).
See example illustrated on page 30.

STANDARD MODELS 3300/9300

Output Device 1 + Output Device 2

DUAL RELAY MODELS 3311/9311

Output Device 2 + Output Device 3

DUAL SSd MODELS 3322/9322

Output Device 1 + Output Device 1

Dual relay or dual SSd model options 3311/3322 and 3322/9322 are fully detailed on page 22.

Designed for use with the following supply voltages:

- 100 - 240V 50-60 Hz 4.0 VA (nominal)**
+/-10% maximum permitted fluctuation
- 12V - 24V (AC/DC) +/-20% 4.0 VA Polarity not required**

WIRING THE CONNECTOR

Prepare the cable carefully, remove a maximum of 8mm insulation and ideally tin to avoid bridging. Prevent excessive cable strain. Maximum recommended wire size: 32/0.2mm 1.0mm² (18AWG).

INDUCTIVE LOADS

To prolong relay contact life and suppress interference it is recommended engineering practice to fit a snubber (0.1uf/100 ohms), refer to illustration on page 30.

CAUTION:

Snubber leakage current can cause some electro-mechanical devices to be held ON. Check with the manufacturers specifications.

ELECTRICAL INSTALLATION (continued)

EN61010 - /CSA 22.2 No 1010.1 92

Compliance shall not be impaired when fitted to the final installation.

Designed to offer a minimum of Basic Insulation only. The body responsible for the installation is to ensure that supplementary insulation suitable for Installation Category II or III is achieved when fully installed.

To avoid possible hazards, accessible conductive parts of the final installation should be protectively earthed in accordance with EN6010 for Class 1 Equipment. Output wiring should be within a Protectively Earthed cabinet.

Sensor sheaths should be bonded to protective earth or not be accessible.

Live parts should not be accessible without the use of a tool.

When fitted to the final installation, an IEC/CSA APPROVED disconnecting device should be used to disconnect both LINE and NEUTRAL conductors simultaneously.

A clear instruction shall be provided not to position the equipment so that it is difficult to operate the disconnecting device.

MODEL 3300 TYPICAL CONNECTION DIAGRAM

The SSR driver output is allocated to SP1 and wired to switch the load (heater) using an SSR

F1 Fuse: time lag type to IEC127. CSA/UL rating 1A 250Vac

F2 Fuse: High Rupture Capacity (HRC) Suitable for maximum rated load current

S1 Switch: IEC/CSA/UL Approved disconnecting Device

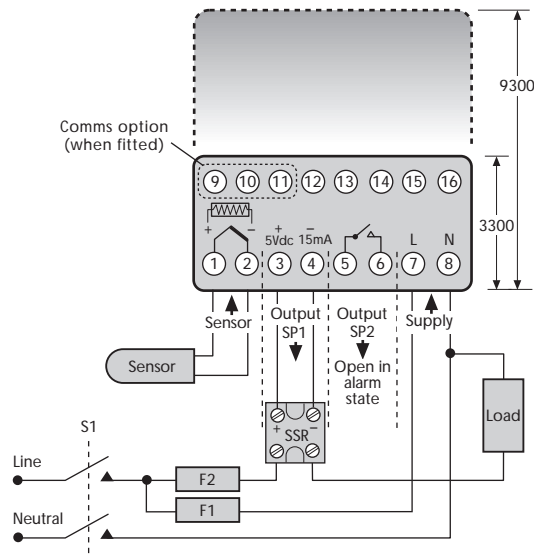

SENSOR SELECTION



Option/Sensor type		Sensor range			Linearity
Thermocouples					
tc b	B	0 to 1800 °C	32 to 3272 F	Pt-30%Rh/Pt-6%Rh	2.0 *
tc E	E	0 to 600 °C	32 to 1112 F	Chromel/Con	0.5
tc J	J	0 to 800 °C	32 to 1472 F	Iron/Constantan	0.5
tc K	K	-50 to 1200 °C	-58 to 2192 F	Chromel/Alumel	0.25*
tc L	L	0 to 800 °C	32 to 1472 F	Fe/Konst	0.5
tc n	N	-50 to 1200 °C	-58 to 2192 F	NiCrosil/NiSil	0.25*
tc r	R	0 to 1600 °C	32 to 2912 F	Pt-13%Rh/Pt	2.0*
tc s	S	0 to 1600 °C	32 to 2912 F	Pt-10%Rh/Pt	2.0*
tc t	T	-200 / 250 °C	-273 / 482 F	Copper/Con	0.25*

Resistance thermometer

rtd	-200 / 400 C	-273 / 752 F	Pt100/RTD-2	0.25*
-----	--------------	--------------	-------------	-------

Linear process inputs (Input mV range: 0 to 50mV)

Displays	0 - 20mV	4 - 20mV	setpoint limits	
Lin1	0 - 100		0 - 400	± 0.5%
Lin2		0 - 100	-25 - 400	± 0.5%
Lin3	0 - 1000		0 - 3000	± 0.5%
Lin4		0 - 1000	-250 - 3000	± 0.5%
Lin5	0 - 2000		0 - 3000	± 0.5%

Notes: 1 Linearity: 5-95% sensor range

2* Linearity B:5° (70° - 500°C) K/N:1° >350°C exceptions: R/S: 5° <300°C T:1° <- -25° >150°C RTD/Pt100: 0.5° <-100°C

SPECIFICATION

Thermocouple

9 types

Standards: IPTS/68/DIN 43710
CJC rejection: 20:1 (0.05°/°C) typical
External resistance: 100Ω maximum

Resistance thermometer

RTD-2/Pt100 2 wire
Standards: DIN 43760
(100Ω 0°C/138.5Ω 100°C Pt)
Bulb current: 0.2mA maximum

Linear process inputs

mV range: 0 to 50mV

Applicable to all inputs SM = sensor maximum

Calibration accuracy: $\pm 0.25\%SM \pm 1^\circ C$
Sampling frequency: input 10Hz, CJC 2 sec.
Common mode rejection: Negligible effect up to 140dB,
240V, 50-60Hz
Series mode rejection: 60dB, 50-60Hz
Temperature coefficient: 150ppm/°C SM
Reference conditions: 22°C $\pm 2^\circ C$, rated voltage after 15
minutes settling time.

Output devices

SSd/SSd1/SSd2: solid state relay driver: To switch a
remote SSR 5Vdc +0/-15% 15mA
non-isolated

Miniature power relay: form A/SPST contacts (AgCdO)
rLY and rLY1: 2A/250ac resistive load
rLY2: 1A/250ac resistive load

General

Displays: Main, 4 Digits high brightness
green LED. 10mm (0.4") high.
Digital range -199 to 9999
Hi-res mode -199.9 to 999.9

LED output indicators - flashing
SP1 square, green; SP2 round, red

Keypad: 3 elastomeric buttons

Environmental

Humidity: Max 80%
Altitude: up to 2000M
Installation: Categories II and III
Pollution: Degree II
Protection: NEMA 4X, IP66
EMC emission: EN50081-1 FCC Rules 15 subpart J
Class A
EMC immunity: EN50082-2
Ambient: 0-50°C (32-130°F)
Mouldings: flame retardant polycarbonate
Weight: 3300: 110g (3.9 oz)
9300: 120g (4.2 oz)

Copyright CAL Controls Ltd. 1997

Not to be reproduced without prior written permission from CAL Controls Ltd. Whilst every effort has been made to ensure the accuracy of the specifications contained in this manual, due to our policy of continuous development, CAL Controls Ltd reserves the right to make changes without prior notice.



CAL Controls
Temperature Controllers



CAL Controls Ltd