

### Module for emergency stops, end position monitoring for movable guards and magnetic safety sensors

#### Main features

- For safety applications up to SIL CL 3/PL e
- Input with 1 or 2 channels
- Choice between automatic start, manual start or monitored start
- Connection of input channels of opposite potentials
- Reduced housing width of 22.5 mm
- Output contacts:  
2 NO safety contacts,  
1 NC auxiliary contact
- Supply voltage:  
10 ... 30 Vdc, 24 Vac/dc, 120 Vac, 230 Vac

#### Utilization categories

Alternating current: AC15 (50...60 Hz)

U<sub>e</sub> (V) 230

I<sub>e</sub> (A) 3

Direct current: DC13 (6 oper. cycles/min.)

U<sub>e</sub> (V) 24

I<sub>e</sub> (A) 4

#### Quality marks and certificates:



EC type examination certificate: IMQ CP 432 DM

UL approval: E131787

CCC approval: 2013010305640211

EAC approval: RU C-IT.AQ35.B.00454

#### Compliance with the requirements of:

Low Voltage Directive 2014/35/EU,

Machinery Directive 2006/42/EC,

EMC Directive 2014/30/EU

#### Technical data

##### Housing

Polyamide housing PA 66, self-extinguishing V0 acc. to UL 94

Protection degree:

IP40 (housing), IP20 (terminal strip)

Dimensions:

see page 295, design A

##### General data

SIL CL:

up to SIL CL 3 acc. to EN 62061

Performance Level (PL):

up to PL e acc. to EN ISO 13849-1

Safety category:

up to cat. 4 acc. to EN ISO 13849-1

Safety parameters:

see page 349

Ambient temperature:

-25°C...+55°C

Mechanical endurance:

>10 million operating cycles

Electrical endurance:

>100,000 operating cycles

Pollution degree:

external 3, internal 2

Impulse withstand voltage (U<sub>imp</sub>):

4 kV

Rated insulation voltage (U<sub>i</sub>):

250 V

Overvoltage category:

II

Weight:

0.3 kg

##### Supply

Rated supply voltage (U<sub>n</sub>):

10 ... 30 Vdc

24 Vac/dc; 50...60 Hz

120 Vac; 50...60 Hz

230 Vac; 50...60 Hz

Max. DC residual ripple in DC:

10%

Supply voltage tolerance:

-10% ... +15% of U<sub>n</sub>

Power consumption AC:

< 5 VA

Power consumption DC:

< 2 W

##### Control circuit

Protection against short circuits:

PTC resistance, I<sub>h</sub>=0.5 A

PTC times:

response time > 100 ms, release time > 3 s

Maximum resistance per input:

≤ 50 Ω

Current per input:

30 mA (typical)

Min. duration of start impulse t<sub>MIN</sub>:

> 100 ms, > 50 ms (E02)

Response time t<sub>A</sub>:

< 50 ms, < 150 ms (E02)

Release time t<sub>R1</sub>:

< 20 ms

Release time in absence of power supply t<sub>R</sub>:

< 70 ms, < 100 ms (E02)

Simultaneity time t<sub>C</sub>:

unlimited

##### In compliance with standards:

EN 60204-1, EN ISO 13855, EN 1037, EN ISO 12100, EN ISO 13850, EN 60529,

EN 61000-6-2, EN 61000-6-3, EN 61326-1, EN 60664-1, EN 60947-1, EN ISO 13849-1,

EN ISO 13849-2, EN 62061, UL 508, CSA C22.2 n° 14-95

##### Output circuit

Output contacts:

2 NO safety contacts,

1 NC auxiliary contact

Contact type:

forcibly guided

Material of the contacts:

gold-plated silver alloy

Maximum switching voltage:

230/240 Vac; 300 Vdc

Max. current per contact:

6 A

Conventional free air thermal current (I<sub>th</sub>):

6 A

Max. total current Σ I<sub>th</sub><sup>2</sup>:

72 A<sup>2</sup>

Minimum current:

10 mA

Contact resistance:

≤ 100 mΩ

External protection fuse:

4 A

The number and the load capacity of output contacts can be increased by using expansion modules or contactors. See page 241-250.

#### Code structure

## CS AR-01V024

Connection type	
<b>V</b>	Screw terminals
<b>M</b>	Connector with screw terminals
<b>X</b>	Connector with spring terminals

Supply voltage	
<b>024</b>	24 Vac/dc
<b>120</b>	120 Vac
<b>230</b>	230 Vac
<b>E02</b>	10 ... 30 Vdc

#### Stock items

CS AR-01V024

CS AR-01V120

CS AR-01VE02

#### Features approved by UL

Rated supply voltage (U<sub>n</sub>): 24 Vac/dc; 50...60 Hz  
120 Vac; 50...60 Hz  
230 Vac; 50...60 Hz

Power consumption AC: < 5 VA

Power consumption DC: < 2 W

Maximum switching voltage: 230 Vac

Max. current per contact: 6 A

Utilization category: C300

Notes:

- Use 60 or 75 °C copper (Cu) conductors, rigid or flexible, wire size 30-12 AWG.

- Tightening torque for terminal screws of 5-7 lb in.

- Only for 24 Vac/dc versions: power supply only with class 2 sources or with limited voltage and energy. (Supply from Remote Class 2 Source or limited voltage limited energy).



### Safety module CS AR-01

#### Pin assignment

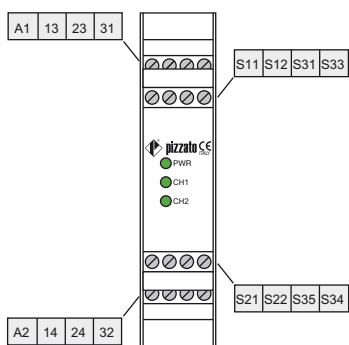

#### Internal block diagram

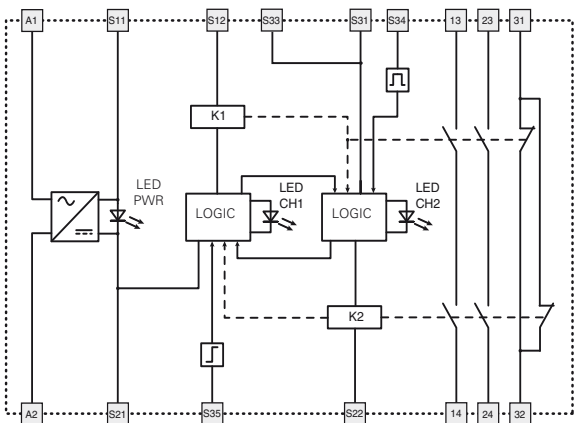

#### Input configuration

Emergency stop circuits	
Input configuration with manual start	
1 channel	2 channels

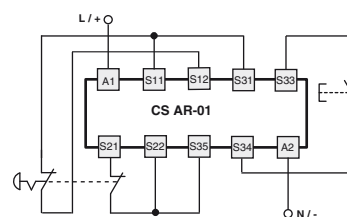
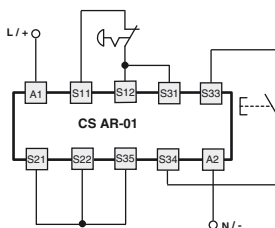

The diagram does not show the exact position of the terminals in the product

#### Automatic start

With regard to the indicated diagrams, bridge the start button between S33 and S34 in order to activate the automatic start module.

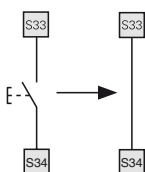

#### Monitored start

With regard to the indicated diagrams, remove the connection between S22 and S35 in order to activate the monitored start module.

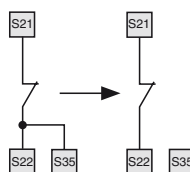

#### Monitoring of movable guards and magnetic safety sensors

The safety module can monitor emergency stop circuits, control circuits for movable guards as well as magnetic safety sensors. Replace the emergency stop contacts with switch contacts or sensor contacts. The sensors can only be used in 2-channel configuration.

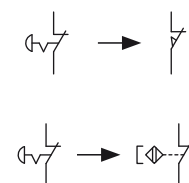

#### Function diagrams

Configuration with automatic start

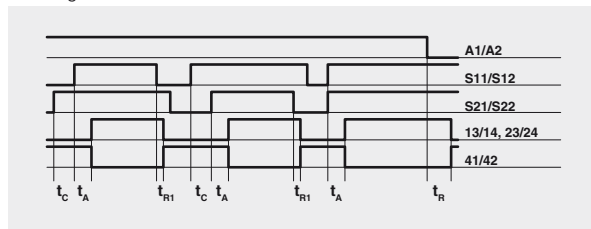

Configuration with monitored start

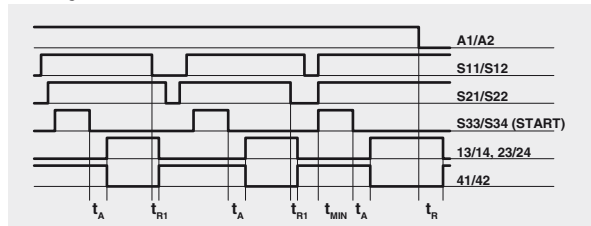

Configuration with manual start

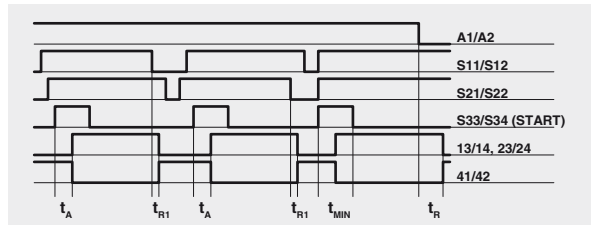

Legend:

- $t_{MIN}$ : Min. duration of start impulse
- $t_c$ : simultaneity time
- $t_A$ : response time
- $t_{R1}$ : release time
- $t_R$ : release time in absence of power supply

Notes:

The configurations with one channel are obtained taking into consideration the S11/S12 input only. In this case it is necessary to consider time  $t_{R1}$  referred to input S11/S12, time  $t_R$  referred to the supply, time  $t_A$  referred to the start, and time  $t_{MIN}$  referred to the start.



### Module for emergency stops, end position monitoring for movable guards and magnetic safety sensors

#### Main features

- For safety applications up to SIL CL 3/PL e
- Input with 1 or 2 channels
- Choice between automatic start, manual start or monitored start
- Connection of input channels of opposite potentials
- Reduced housing width of 22.5 mm
- Output contacts:  
3 NO safety contacts
- Supply voltage:  
10 ... 30 Vdc, 24 Vac/dc, 120 Vac, 230 Vac

#### Utilization categories

Alternating current: AC15 (50...60 Hz)

U<sub>e</sub> (V) 230

I<sub>e</sub> (A) 3

Direct current: DC13 (6 oper. cycles/min.)

U<sub>e</sub> (V) 24

I<sub>e</sub> (A) 4

#### Quality marks and certificates:



EC type examination certificate: IMQ CP 432 DM

UL approval: E131787

CCC approval: 2013010305640211

EAC approval: RU C-IT.AQ35.B.00454

#### Compliance with the requirements of:

Low Voltage Directive 2014/35/EU,

Machinery Directive 2006/42/EC,

EMC Directive 2014/30/EU

#### Technical data

##### Housing

Polyamide housing PA 66, self-extinguishing V0 acc. to UL 94

Protection degree:

IP40 (housing), IP20 (terminal strip)

Dimensions:

see page 295, design A

##### General data

SIL CL:

up to SIL CL 3 acc. to EN 62061

Performance Level (PL):

up to PL e acc. to EN ISO 13849-1

Safety category:

up to cat. 4 acc. to EN ISO 13849-1

Safety parameters:

see page 349

Ambient temperature:

-25°C...+55°C

Mechanical endurance:

>10 million operating cycles

Electrical endurance:

>100,000 operating cycles

Pollution degree:

external 3, internal 2

Impulse withstand voltage (U<sub>imp</sub>):

4 kV

Rated insulation voltage (U<sub>i</sub>):

250 V

Overtoltage category:

II

Weight:

0.3 kg

##### Supply

Rated supply voltage (U<sub>n</sub>):

10 ... 30 Vdc

24 Vac/dc; 50...60 Hz

120 Vac; 50...60 Hz

230 Vac; 50...60 Hz

Max. DC residual ripple in DC:

10%

Supply voltage tolerance:

±15% of U<sub>n</sub>

Power consumption AC:

< 5 VA

Power consumption DC:

< 2 W

##### Control circuit

Protection against short circuits:

PTC resistance, I<sub>h</sub>=0.5 A

PTC times:

Response time > 100 ms, release time > 3 s

Maximum resistance per input:

≤ 50 Ω

Current per input:

< 30 mA

Min. duration of start impulse t<sub>MIN</sub>:

> 100 ms

Response time t<sub>A</sub>:

< 50 ms

Release time t<sub>R1</sub>:

< 20 ms

Release time in absence of power supply t<sub>R</sub>:

< 70 ms

Simultaneity time t<sub>C</sub>:

unlimited

##### In compliance with standards:

EN 60204-1, EN ISO 13855, EN 1037, EN ISO 12100, EN ISO 13850, EN 60529,

EN 61000-6-2, EN 61000-6-3, EN 61326-1, EN 60664-1, EN 60947-1, EN ISO 13849-1,

EN ISO 13849-2, EN 62061, UL 508, CSA C22.2 n° 14-95

##### Output circuit

Output contacts:

3 NO safety contacts,

Contact type:

forcibly guided

Material of the contacts:

gold-plated silver alloy

Maximum switching voltage:

230/240 Vac; 300 Vdc

Max. current per contact:

6 A

Conventional free air thermal current (I<sub>th</sub>):

6 A

Max. total current Σ I<sub>th</sub><sup>2</sup>:

72 A<sup>2</sup>

Minimum current:

10 mA

Contact resistance:

≤ 100 mΩ

External protection fuse:

4 A

The number and the load capacity of output contacts can be increased by using expansion modules or contactors. See page 241-250.

#### Code structure

## CS AR-02V024

#### Connection type

<b>V</b>	Screw terminals
<b>M</b>	Connector with screw terminals
<b>X</b>	Connector with spring terminals

#### Supply voltage

<b>024</b>	24 Vac/dc
<b>120</b>	120 Vac
<b>230</b>	230 Vac
<b>E02</b>	10 ... 30 Vdc

#### Stock items

CS AR-02V024

#### Features approved by UL

Rated supply voltage (U <sub>n</sub> ):	24 Vac/dc; 50...60 Hz 120 Vac; 50...60 Hz 230 Vac; 50...60 Hz
Power consumption AC:	< 5 VA
Power consumption DC:	< 2 W
Maximum switching voltage:	230 Vac
Max. current per contact:	6 A
Utilization category	C300

#### Notes:

- Use 60 or 75 °C copper (Cu) conductors, rigid or flexible, wire size 30-12 AWG.
- Tightening torque for terminal screws of 5-7 lb in.
- Only for 24 Vac/dc versions: power supply only with class 2 sources or with limited voltage and energy. (Supply from Remote Class 2 Source or limited voltage limited energy).



### Safety module CS AR-02

#### Pin assignment

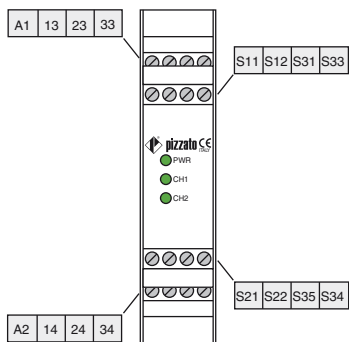

#### Internal block diagram

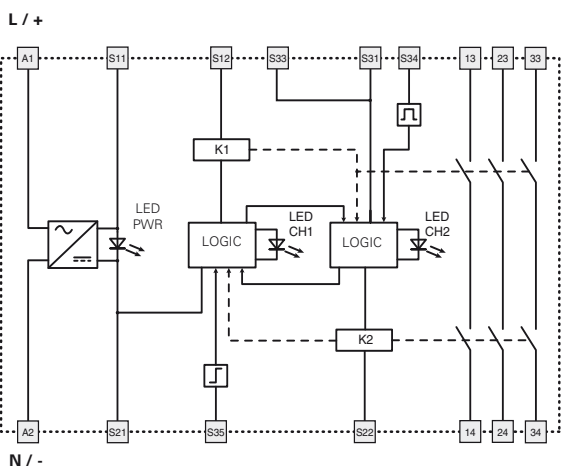

#### Function diagrams

Configuration with automatic start

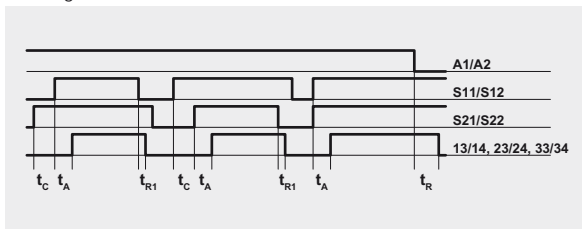

Configuration with monitored start

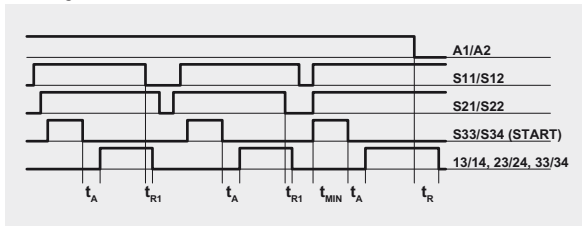

Configuration with manual start

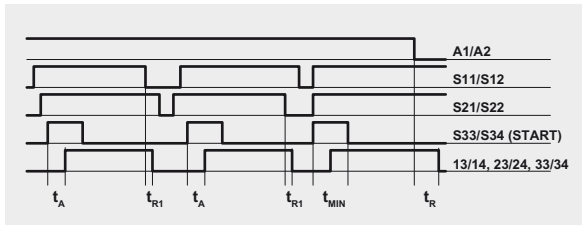

Legend: t\_min: Min. duration of start impulse; t\_c: simultaneity time; t\_a: response time; t\_r1: release time; t\_r: release time in absence of power supply

Notes: The configurations with one channel are obtained taking into consideration the S11/S12 input only. In this case it is necessary to consider time t\_r1 referred to input S11/S12, time t\_r referred to the supply, time t\_a referred to input S11/S12 and to the start, and time t\_min referred to the start.

#### Input configuration

Emergency stop circuits	
Input configuration with manual start	
1 channel	2 channels

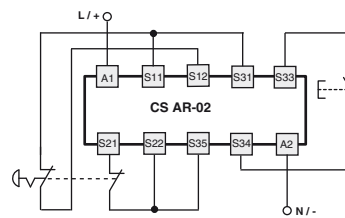
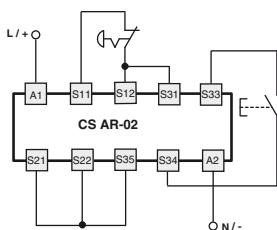

The diagram does not show the exact position of the terminals in the product

#### Automatic start

With regard to the indicated diagrams, bridge the start button between S33 and S34 in order to activate the automatic start module.

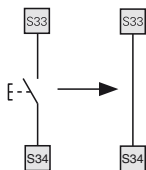

#### Monitored start

With regard to the indicated diagrams, remove the connection between S22 and S35 in order to activate the monitored start module.

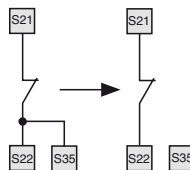

#### Monitoring of movable guards and magnetic safety sensors

The safety module can monitor emergency stop circuits, control circuits for movable guards as well as magnetic safety sensors. Replace the emergency stop contacts with switch contacts or sensor contacts. The sensors can only be used in 2-channel configuration.

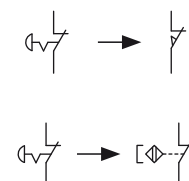



### Module for emergency stops, end position monitoring for movable guards and magnetic safety sensors

#### Main features

- For safety applications up to SIL CL 3/PL e
- Input with 1 or 2 channels
- Choice between automatic start, manual start or monitored start
- Connection of input channels of opposite potentials
- Reduced housing width of 22.5 mm
- Output contacts:  
3 NO safety contacts,  
1 NC auxiliary contact
- Supply voltage:  
24 Vac/dc, 120 Vac, 230 Vac

#### Utilization categories

Alternating current: AC15 (50...60 Hz)

U<sub>e</sub> (V) 230

I<sub>e</sub> (A) 3

Direct current: DC13 (6 oper. cycles/min.)

U<sub>e</sub> (V) 24

I<sub>e</sub> (A) 4

#### Quality marks and certificates:



EC type examination certificate: IMQ CP 432 DM

UL approval: E131787

CCC approval: 2013010305640211

EAC approval: RU C-IT.AД35.B.00454

#### Compliance with the requirements of:

Low Voltage Directive 2014/35/EU,

Machinery Directive 2006/42/EC,

EMC Directive 2014/30/EU

#### Technical data

##### Housing

Polyamide housing PA 66, self-extinguishing V0 acc. to UL 94

Protection degree:

IP40 (housing), IP20 (terminal strip)

Dimensions:

see page 295, design A

##### General data

SIL CL:

up to SIL CL 3 acc. to EN 62061

Performance Level (PL):

up to PL e acc. to EN ISO 13849-1

Safety category:

up to cat. 4 acc. to EN ISO 13849-1

Safety parameters:

see page 349

Ambient temperature:

-25°C...+55°C

Mechanical endurance:

>10 million operating cycles

Electrical endurance:

>100,000 operating cycles

Pollution degree:

external 3, internal 2

Impulse withstand voltage (U<sub>imp</sub>):

4 kV

Rated insulation voltage (U<sub>i</sub>):

250 V

Oversvoltage category:

II

Weight:

0.3 kg

##### Supply

Rated supply voltage (U<sub>n</sub>):

24 Vac/dc; 50...60 Hz

120 Vac; 50...60 Hz

230 Vac; 50...60 Hz

Max. DC residual ripple in DC:

10%

Supply voltage tolerance:

±15% of U<sub>n</sub>

Power consumption AC:

< 5 VA

Power consumption DC:

< 2 W

##### Control circuit

Protection against short circuits:

PTC resistance, I<sub>h</sub>=0.5 A

PTC times:

Response time > 100 ms, release time > 3 s

Maximum resistance per input:

≤ 50 Ω

Current per input:

30 mA (typical)

Min. duration of start impulse t<sub>MIN</sub>:

> 100 ms

Response time t<sub>A</sub>:

< 50 ms

Release time t<sub>R1</sub>:

< 20 ms

Release time in absence of power supply t<sub>R</sub>:

< 70 ms

Simultaneity time t<sub>c</sub>:

unlimited

##### In compliance with standards:

EN 60204-1, EN ISO 13855, EN 1037, EN ISO 12100, EN ISO 13850, EN 60529,

EN 61000-6-2, EN 61000-6-3, EN 61326-1, EN 60664-1, EN 60947-1, EN ISO 13849-1,

EN ISO 13849-2, EN 62061, UL 508, CSA C22.2 n° 14-95

##### Output circuit

Output contacts:

3 NO safety contacts

1 NC auxiliary contact

forcibly guided

Contact type:

gold-plated silver alloy

Material of the contacts:

230/240 Vac; 300 Vdc

Maximum switching voltage:

6 A

Max. current per contact:

6 A

Conventional free air thermal current (I<sub>th</sub>):

6 A

Max. total current Σ I<sub>th</sub><sup>2</sup>:

64 A<sup>2</sup>

Minimum current:

10 mA

Contact resistance:

≤ 100 mΩ

External protection fuse:

4 A

The number and the load capacity of output contacts can be increased by using expansion modules or contactors. see page 241-250.

#### Code structure

## CS AR-04V024

Connection type	
<b>V</b>	Screw terminals
<b>M</b>	Connector with screw terminals
<b>X</b>	Connector with spring terminals

Supply voltage	
<b>024</b>	24 Vac/dc
<b>120</b>	120 Vac
<b>230</b>	230 Vac

#### Stock items

CS AR-04V024

#### Features approved by UL

Rated supply voltage (U<sub>n</sub>):  
24 Vac/dc; 50...60 Hz  
120 Vac; 50...60 Hz  
230 Vac; 50...60 Hz

Power consumption AC:  
< 5 VA

Power consumption DC:  
< 2 W

Maximum switching voltage:  
230 Vac

Max. current per contact:  
6 A

Utilization category  
C300

Notes:

- Use 60 or 75 °C copper (Cu) conductors, rigid or flexible, wire size 30-12 AWG.

- Tightening torque for terminal screws of 5-7 lb in.

- Only for 24 Vac/dc versions: power supply only with class 2 sources or with limited voltage and energy. (Supply from Remote Class 2 Source or limited voltage limited energy).



### Safety module CS AR-04

#### Pin assignment

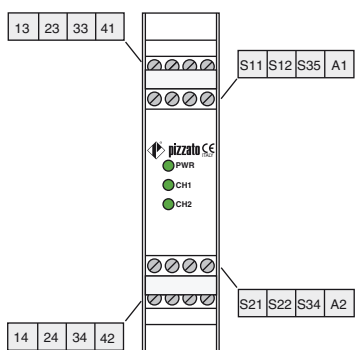

#### Internal block diagram

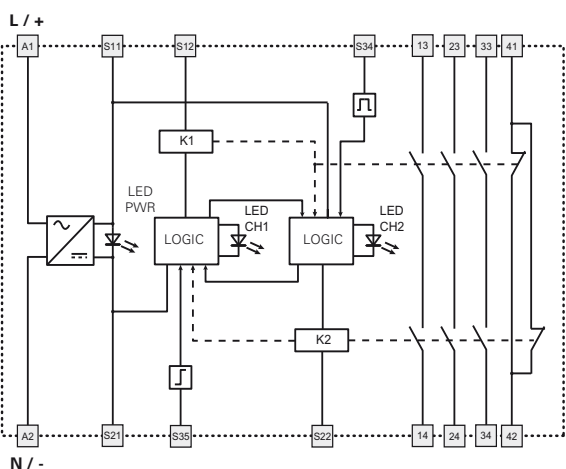

#### Input configuration

Emergency stop circuits	
Input configuration with manual start	
1 channel	2 channels

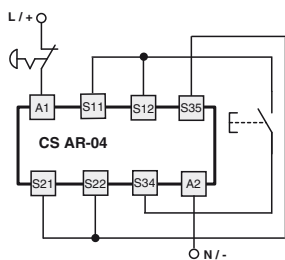

The diagram does not show the exact position of the terminals in the product

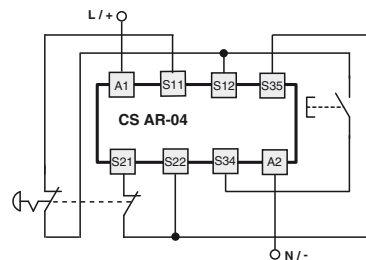

#### Automatic start

With regard to the indicated diagrams, bridge the start button between S12 and S34 in order to activate the automatic start module.

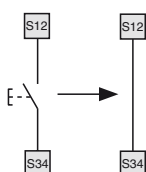

#### Monitored start

With regard to the indicated diagrams, remove the connection between S22 and S35 in order to activate the monitored start module.

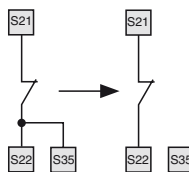

#### Monitoring of movable guards and magnetic safety sensors

The safety module can monitor emergency stop circuits, control circuits for movable guards as well as magnetic safety sensors. Replace the emergency stop contacts with switch contacts or sensor contacts. The sensors can only be used in 2-channel configuration.

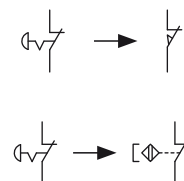

#### Function diagrams

Configuration with automatic start

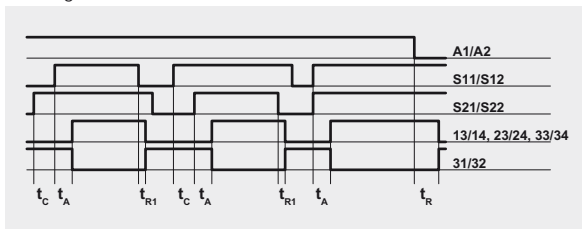

Configuration with monitored start

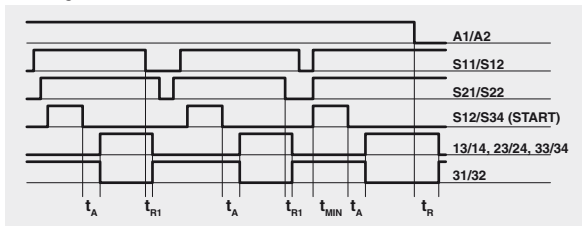

Configuration with manual start

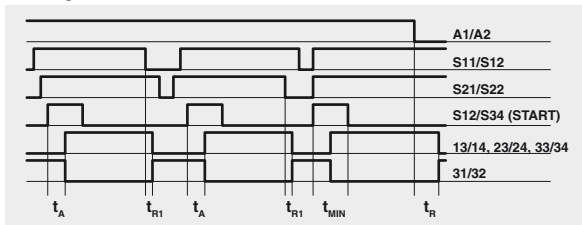

- Legend:
- $t_{MIN}$ : Min. duration of start impulse
  - $t_c$ : simultaneity time
  - $t_A$ : response time
  - $t_R$ : release time
  - $t_{R1}$ : release time in absence of power supply

Notes: The configurations with one channel are obtained taking into consideration only the effect of the S11/S12 input on the supply. In this case it is necessary to consider time  $t_{R1}$  referred to input S11/S12, time  $t_R$  referred to the supply, time  $t_A$  referred to input S11/S12 and to the start, and time  $t_{MIN}$ .

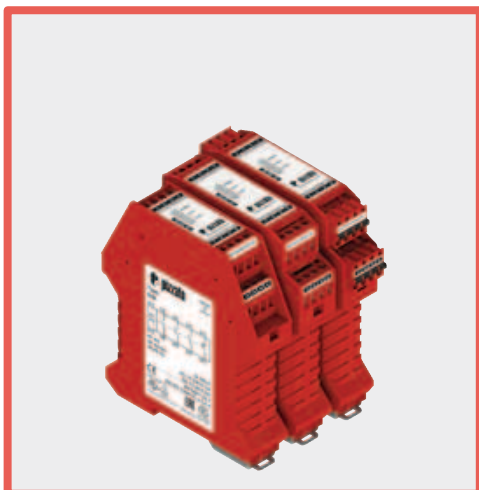

**Module for emergency stops, end position monitoring for movable guards, semiconductor outputs (e.g. light barriers) and magnetic safety sensors**

#### Main features

- For safety applications up to SIL CL 3/PL e
- Input with 1 or 2 channels
- Choice between automatic start, manual start (CS AR-05 only) or monitored start (CS AR-06 only)
- Can be connected to semiconductor outputs (e.g. light barriers), to electromechanical contacts or to magnetic safety sensors
- Output contacts:
  - 3 NO safety contacts,
  - 1 NC auxiliary contact
- Supply voltage:
  - 24 Vac/dc, 120 Vac, 230 Vac

#### Utilization categories

Alternating current: AC15 (50...60 Hz)

U<sub>e</sub> (V) 230

I<sub>e</sub> (A) 3

Direct current: DC13 (6 oper. cycles/min.)

U<sub>e</sub> (V) 24

I<sub>e</sub> (A) 4

#### Quality marks and certificates:



EC type examination certificate: IMQ CP 432 DM

UL approval: E131787

CCC approval: 2013010305640211

EAC approval: RU C-IT.AQ35.B.00454

#### Compliance with the requirements of:

Low Voltage Directive 2014/35/EU,

Machinery Directive 2006/42/EC,

EMC Directive 2014/30/EU

#### Technical data

##### Housing

Polyamide housing PA 66, self-extinguishing V0 acc. to UL 94

Protection degree:

IP40 (housing), IP20 (terminal strip)

Dimensions:

see page 295, design A

##### General data

SIL CL:

up to SIL CL 3 acc. to EN 62061

Performance Level (PL):

up to PL e acc. to EN ISO 13849-1

Safety category:

up to cat. 4 acc. to EN ISO 13849-1

Safety parameters:

see page 349

Ambient temperature:

-25°C...+55°C

Mechanical endurance:

>10 million operating cycles

Electrical endurance:

>100,000 operating cycles

Pollution degree:

external 3, internal 2

Impulse withstand voltage (U<sub>imp</sub>):

4 kV

Rated insulation voltage (U<sub>i</sub>):

250 V

Overtoltage category:

II

Weight:

0.3 kg

##### Supply

Rated supply voltage (U<sub>n</sub>):

24 Vac/dc; 50...60 Hz

120 Vac; 50...60 Hz

230 Vac; 50...60 Hz

Max. DC residual ripple in DC:

10%

Supply voltage tolerance:

±15% of U<sub>n</sub>

Power consumption AC:

< 5 VA

Power consumption DC:

< 2 W

##### Control circuit

Protection against short circuits:

PTC resistance, I<sub>h</sub>=0.5 A

PTC times:

Response time > 100 ms, release time > 3 s

Maximum resistance per input:

≤ 50 Ω

Current per input:

< 30 mA

Min. duration of start impulse t<sub>MIN</sub>:

> 250 ms

Response time t<sub>A</sub>:

< 200 ms

Release time t<sub>R1</sub>:

< 20 ms

Release time in absence of power supply t<sub>R</sub>:

< 70 ms

Simultaneity time t<sub>c</sub>:

unlimited

##### In compliance with standards:

EN 60204-1, EN ISO 13855, EN 1037, EN ISO 12100, EN ISO 13850, EN 60529,

EN 61000-6-2, EN 61000-6-3, EN 61326-1, EN 60664-1, EN 60947-1, EN ISO 13849-1,

EN ISO 13849-2, EN 62061, UL 508, CSA C22.2 n° 14-95

##### Output circuit

Output contacts:

3 NO safety contacts

1 NC auxiliary contact

forcibly guided

gold-plated silver alloy

230/240 Vac; 300 Vdc

6 A

Contact type:

Material of the contacts:

Maximum switching voltage:

Max. current per contact:

Conventional free air thermal current (I<sub>th</sub>):

Max. total current Σ I<sub>th</sub><sup>2</sup>:

Minimum current:

Contact resistance:

External protection fuse:

6 A

64 A<sup>2</sup>

10 mA

≤ 100 mΩ

4 A

The number and the load capacity of output contacts can be increased by using expansion modules or contactors. see page 241-250.

#### Code structure

## CS AR-05V024

##### Start mode

**05** manual or automatic start

**06** monitored start

##### Connection type

**V** Screw terminals

**M** Connector with screw terminals

**X** Connector with spring terminals

##### Supply voltage

**024** 24 Vac/dc

**120** 120 Vac

**230** 230 Vac

#### Stock items

CS AR-05V024

CS AR-06V024

#### Features approved by UL

Rated supply voltage (U<sub>n</sub>):

24 Vac/dc; 50...60 Hz

120 Vac; 50...60 Hz

230 Vac; 50...60 Hz

< 5 VA

Power consumption AC:

Power consumption DC:

Maximum switching voltage:

Max. current per contact:

Utilization category

230 Vac

6 A

C300

Notes:

- Use 60 or 75 °C copper (Cu) conductors, rigid or flexible, wire size 30-12 AWG.

- Tightening torque for terminal screws of 5-7 lb in.

- Only for 24 Vac/dc versions: power supply only with class 2 sources or with limited voltage and energy. (Supply from Remote Class 2 Source or limited voltage limited energy).



# Safety module CS AR-05-06

## Pin assignment

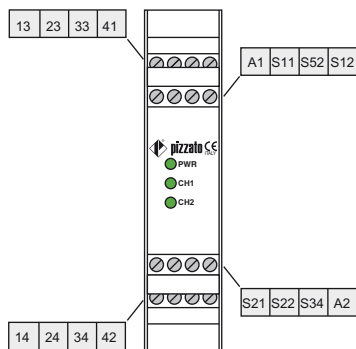

## Internal block diagram

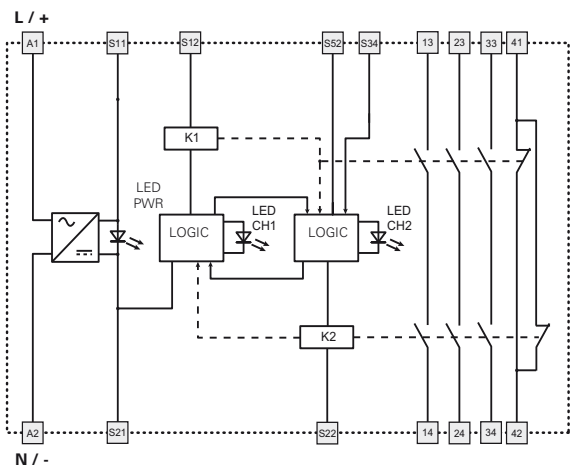

## Input configuration

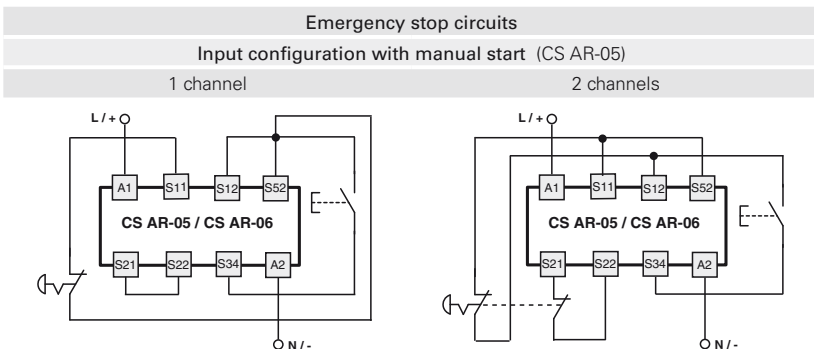
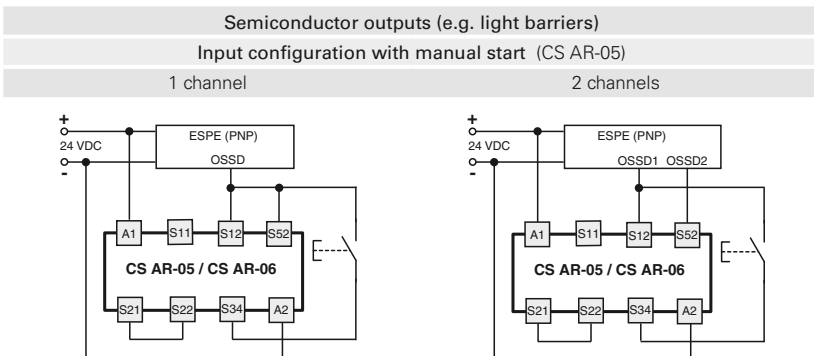

The diagram does not show the exact position of the terminals in the product

Items with code on **green** background are stock items

## Function diagrams

Configuration with automatic start (CS AR-05 only)

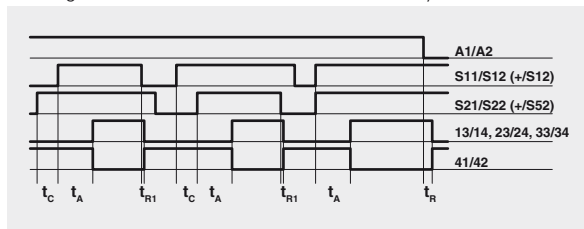

Configuration with monitored start (CS AR-06 only)

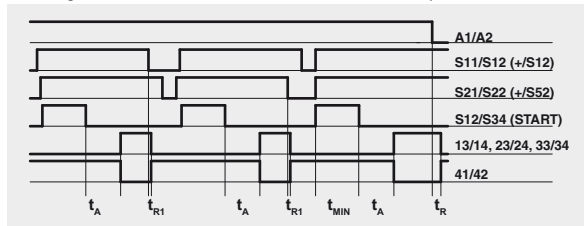

Configuration with manual start (CS AR-05 only)

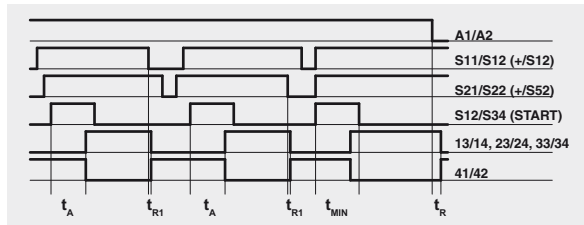

Legend:

- $t_{MIN}$ : Min. duration of start impulse
- $t_C$ : simultaneity time
- $t_A$ : response time
- $t_{R1}$ : release time
- $t_R$ : release time in absence of power supply

Notes:

The configurations with one channel are obtained taking into consideration the CH1 input only. In this case it is necessary to consider time  $t_{R1}$  referred to input CH1, time  $t_R$  referred to the supply, time  $t_A$  referred to input CH1 and to the start, and time  $t_{MIN}$  referred to the start.

## Automatic start (CS AR-05 only)

Bridge the start button between S12 and S34 in order to activate the automatic start module.

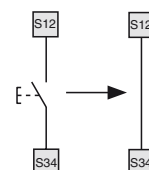

## Monitored start

Use module CS AR-06 with the circuit diagrams for manual start.

## Monitoring of movable guards and magnetic safety sensors

The safety module can monitor emergency stop circuits, control circuits for movable guards as well as magnetic safety sensors. Replace the emergency stop contacts with switch contacts or sensor contacts. The sensors can only be used in 2-channel configuration.

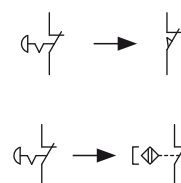





### Module for emergency stops and end position monitoring for movable guards

#### Main features

- For safety applications up to SIL CL 3/PL e
- Input with 1 or 2 channels
- Choice between automatic start, manual start or monitored start
- Connection of input channels of opposite potentials
- Reduced housing width of 22.5 mm
- Output contacts:  
4 NO safety contacts,  
1 NC auxiliary contact
- Supply voltage:  
24 Vac/dc

#### Utilization categories

Alternating current: AC15 (50...60 Hz)

U<sub>e</sub> (V) 230

I<sub>e</sub> (A) 3

Direct current: DC13 (6 oper. cycles/min.)

U<sub>e</sub> (V) 24

I<sub>e</sub> (A) 4

#### Quality marks and certificates:



EC type examination certificate: IMQ CP 432 DM

UL approval: E131787

CCC approval: 2013010305640211

EAC approval: RU C-IT.A.35.B.00454

#### Compliance with the requirements of:

Low Voltage Directive 2014/35/EU,

Machinery Directive 2006/42/EC,

EMC Directive 2014/30/EU

### Technical data

#### Housing

Polyamide housing PA 66, self-extinguishing V0 acc. to UL 94

Protection degree:

IP40 (housing), IP20 (terminal strip)

Dimensions:

see page 295, design B

#### General data

SIL CL:

up to SIL CL 3 acc. to EN 62061

Performance Level (PL):

up to PL e acc. to EN ISO 13849-1

Safety category:

up to cat. 4 acc. to EN ISO 13849-1

Safety parameters:

see page 349

Ambient temperature:

-25°C...+55°C

Mechanical endurance:

>10 million operating cycles

Electrical endurance:

>100,000 operating cycles

Pollution degree:

external 3, internal 2

Impulse withstand voltage (U<sub>imp</sub>):

4 kV

Rated insulation voltage (U<sub>i</sub>):

250 V

Overvoltage category:

II

Weight:

0.3 kg

#### Supply

Rated supply voltage (U<sub>n</sub>):

24 Vac/dc; 50...60 Hz

Max. DC residual ripple in DC:

10%

Supply voltage tolerance:

±15% of U<sub>n</sub>

Power consumption AC:

< 5 VA

Power consumption DC:

< 2 W

#### Control circuit

Protection against short circuits:

PTC resistance, I<sub>h</sub>=0.5 A

PTC times:

Response time > 100 ms, release time > 3 s

Maximum resistance per input:

≤ 50 Ω

Current per input:

30 mA (typical)

Min. duration of start impulse t<sub>MIN</sub>:

> 100 ms

Response time t<sub>A</sub>:

< 70 ms

Release time t<sub>R1</sub>:

< 40 ms

Release time in absence of power supply t<sub>R2</sub>:

< 80 ms

Simultaneity time t<sub>c</sub>:

unlimited

#### In compliance with standards:

EN 60204-1, EN ISO 13855, EN 1037, EN ISO 12100, EN ISO 13850, EN 60529,

EN 61000-6-2, EN 61000-6-3, EN 61326-1, EN 60664-1, EN 60947-1, EN ISO 13849-1,

EN ISO 13849-2, EN 62061, UL 508, CSA C22.2 n° 14-95

#### Output circuit

Output contacts:

4 NO safety contacts

1 NC auxiliary contact

forcibly guided

Contact type:

gold-plated silver alloy

Material of the contacts:

230/240 Vac; 220 Vdc

Maximum switching voltage:

6 A

Max. current per contact:

6 A

Conventional free air thermal current (I<sub>th</sub>):

72 A<sup>2</sup>

Max. total current Σ I<sub>th</sub><sup>2</sup>:

10 mA

Minimum current:

Contact resistance:

≤ 100 mΩ

External protection fuse:

4 A

The number and the load capacity of output contacts can be increased by using expansion modules or contactors. See page 241-250.

### Code structure

## CS AR-07M024

#### Connection type

**M** Connector with screw terminals

**X** Connector with spring terminals

#### Supply voltage

**024** 24 Vac/dc

### Stock items

CS AR-07M024

#### Features approved by UL

Rated supply voltage (U<sub>n</sub>): 24 Vac/dc; 50...60 Hz

Power consumption AC: < 5 VA

Power consumption DC: < 2 W

Maximum switching voltage: 230 Vac

Max. current per contact: 6 A

Utilization category: C300

#### Notes:

- Use 60 or 75 °C copper (Cu) conductors, rigid or flexible, wire size 30-12 AWG.

- Tightening torque for terminal screws of 5-7 lb in.

- Only for 24 Vac/dc versions: power supply only with class 2 sources or with limited voltage and energy. (Supply from Remote Class 2 Source or limited voltage limited energy).



# Safety module CS AR-07

## Pin assignment

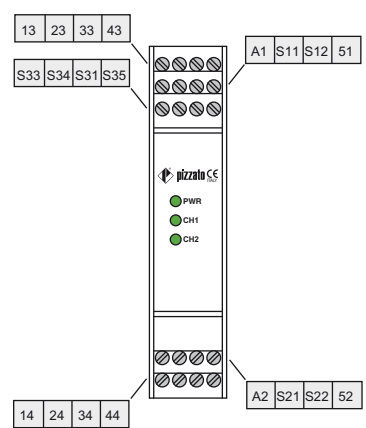

## Internal block diagram

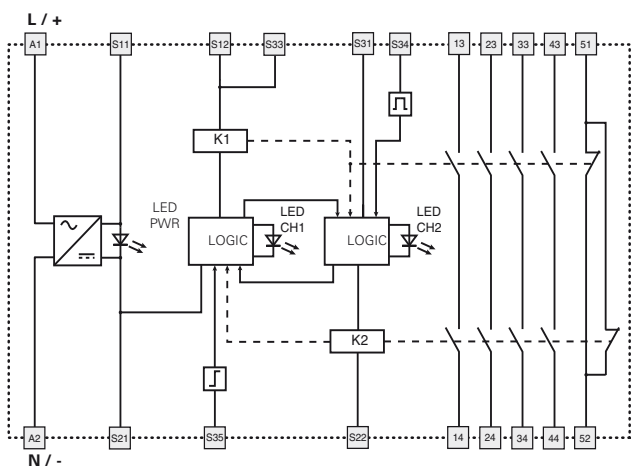

## Input configuration

Emergency stop circuits	
Input configuration with manual start	
1 channel	2 channels

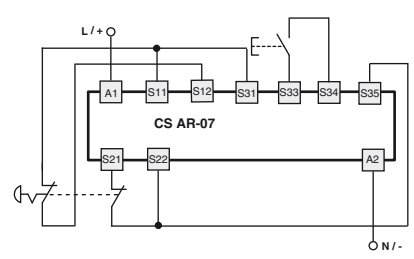
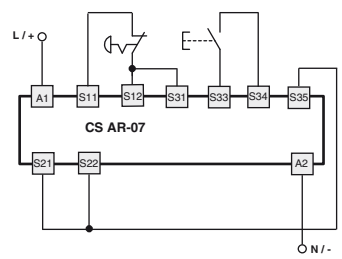

The diagram does not show the exact position of the terminals in the product

### Automatic start

With regard to the indicated diagrams, bridge the start button between S33 and S34 in order to activate the automatic start module.

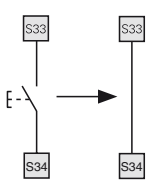

### Monitored start

With regard to the indicated diagrams, remove the connection between S22 and S35 in order to activate the monitored start module.

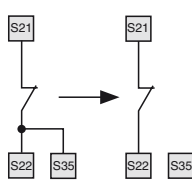

### Movable guard monitoring

The safety module can monitor emergency stop circuits and control circuits for movable guards. Replace the emergency stop contacts with the switch contacts.

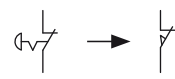

## Function diagrams

Configuration with automatic start

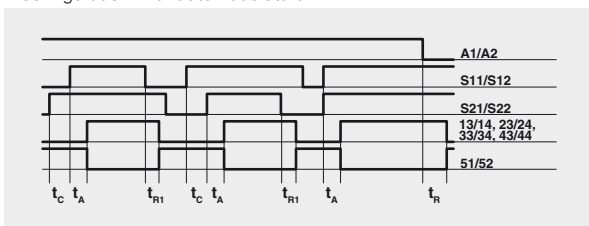

Configuration with monitored start

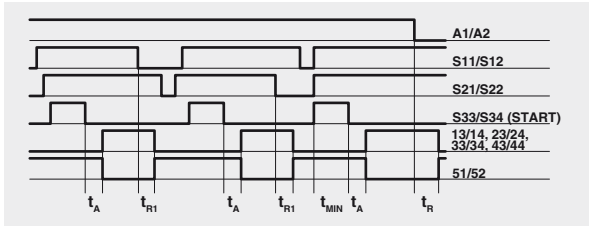

Configuration with manual start

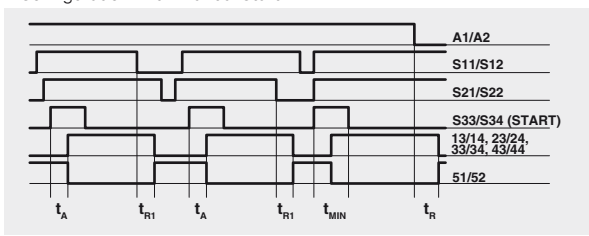

- Legend:
- $t_{MIN}$ : Min. duration of start impulse
  - $t_C$ : simultaneity time
  - $t_A$ : response time
  - $t_{R1}$ : release time
  - $t_R$ : release time in absence of power supply

Notes: The configurations with one channel are obtained taking into consideration the S11/S12 input only. In this case it is necessary to consider time  $t_{R1}$  referred to input S11/S12, time  $t_R$  referred to the supply, time  $t_A$  referred to input S11/S12 and to the start, and time  $t_{MIN}$  referred to the start.



**Module for emergency stops, end position monitoring for movable guards, semiconductor outputs (e.g. light barriers) and magnetic safety sensors**

#### Main features

- For safety applications up to SIL CL 3/PL e
- Input with 1 or 2 channels
- Choice between automatic start, manual start or monitored start
- Can be connected to semiconductor outputs (e.g. light barriers), to electromechanical contacts or to magnetic safety sensors
- Output contacts:  
2 NO safety contacts
- Supply voltage:  
12 Vdc, 24 Vac/dc, 120 Vac, 230 Vac
- Possibility of parallel reset of several modules

#### Utilization categories

Alternating current: AC15 (50...60 Hz)

U<sub>e</sub> (V) 230

I<sub>e</sub> (A) 3

Direct current: DC13 (6 oper. cycles/min.)

U<sub>e</sub> (V) 24

I<sub>e</sub> (A) 4

#### Quality marks:



EC type examination certificate: IMQ CP 432 DM

UL approval: E131787

CCC approval: 2013010305640211 TÜV

SÜD approval: Z10 10 09 75157 002

EAC approval: RU C-IT.AD35.B.00454

#### Compliance with the requirements of:

Low Voltage Directive 2014/35/EU,

Machinery Directive 2006/42/EC,

EMC Directive 2014/30/EU

#### Code structure

## CS AR-08V024

Connection type	Supply voltage
<b>V</b> Screw terminals	<b>U12</b> 12 Vdc
<b>M</b> Connector with screw terminals	<b>024</b> 24 Vac/dc
<b>X</b> Connector with spring terminals	<b>120</b> 120 Vac
	<b>230</b> 230 Vac

#### Stock items

CS AR-08V024

#### Technical data

##### Housing

Polyamide housing PA 66, self-extinguishing V0 acc. to UL 94

Protection degree:

IP40 (housing), IP20 (terminal strip)

Dimensions:

see page 295, design A

##### General data

SIL CL:

up to SIL CL 3 acc. to EN 62061

Performance Level (PL):

up to PL e acc. to EN ISO 13849-1

Safety category:

up to cat. 4 acc. to EN ISO 13849-1

Safety parameters:

see page 349

Ambient temperature:

-25°C...+55°C

Mechanical endurance:

>10 million operating cycles

Electrical endurance:

>100,000 operating cycles

Pollution degree:

external 3, internal 2

Impulse withstand voltage (U<sub>imp</sub>):

4 kV

Rated insulation voltage (U<sub>i</sub>):

250 V

Oversvoltage category:

II

Weight:

0.3 kg

##### Supply

Rated supply voltage (U<sub>n</sub>):

12 Vdc  
24 Vac/dc; 50...60 Hz  
120 Vac; 50...60 Hz  
230 Vac; 50...60 Hz

Max. DC residual ripple in DC:

10%

Supply voltage tolerance

±15% of U<sub>n</sub>

24 Vac/dc, 120 Vac, 230 Vac:

Supply voltage tolerance 12 Vdc:

-10% ... +15% of U<sub>n</sub>

Power consumption AC:

< 5 VA

Power consumption DC:

< 2 W

##### Control circuit

Protection against short circuits:

PTC resistance, I<sub>h</sub>=0.5 A

PTC times:

Response time > 100 ms, release time > 3 s

Maximum resistance per input:

≤ 50 Ω (15 Ω)\*

Current per input:

30 mA (70 mA)\* (typical)

Min. duration of start impulse t<sub>MIN</sub>:

> 200 ms (100 ms)\*

Response time t<sub>A</sub>:

< 150 ms (220 ms)\*

Release time t<sub>R1</sub>:

< 20 ms (15 ms)\*

Release time in absence of power supply t<sub>R2</sub>:

< 150 ms (50 ms)\*

Simultaneity time t<sub>C</sub>:

unlimited

\* Version CS AR-08•U12

##### In compliance with standards:

EN 60204-1, EN ISO 13855, EN 1037, EN ISO 12100, EN ISO 13850, EN 60529,

EN 61000-6-2, EN 61000-6-3, EN 61326-1, EN 60664-1, EN 60947-1, EN ISO 13849-1,

EN ISO 13849-2, EN 62061, UL 508, CSA C22.2 n° 14-95

##### Output circuit

Output contacts:

2 NO safety contacts,

Contact type:

forcibly guided

Material of the contacts:

gold-plated silver alloy

Maximum switching voltage:

230/240 Vac; 300 Vdc

Max. current per contact:

6 A

Conventional free air thermal current (I<sub>th</sub>):

6 A

Max. total current Σ I<sub>th</sub><sup>2</sup>:

36 A<sup>2</sup>

Minimum current:

10 mA

Contact resistance:

≤ 100 mΩ

External protection fuse:

4 A

The number and the load capacity of output contacts can be increased by using expansion modules or contactors. see page 241-250.

##### Features approved by UL

Rated supply voltage (U<sub>n</sub>): 24 Vac/dc, 50...60 Hz, 120 Vac;

50...60 Hz: 230 Vac; 50...60 Hz

Power consumption AC: < 5 VA

Power consumption DC: < 2 W

Maximum switching voltage: 230 Vac

Max. current per contact: 6 A

Utilization category: C300

- Use 60 or 75 °C copper (Cu) conductors, rigid or flexible, wire size 30-12 AWG.

- Tightening torque for terminal screws of 5-7 lb in.

- Only for 24 Vac/dc versions: power supply only with class 2 sources or with limited voltage and energy. (Supply from Remote Class 2 Source or limited voltage limited energy).

##### Features approved by TÜV SÜD

Rated supply voltage (U<sub>n</sub>): 24 Vac/dc, ± 15%, 120 Vac ± 15%,

230 Vac ± 15%

Power consumption: 5 VA max AC, 2 W max DC

Rated operating current (max.): 4 A

Maximum switching load (max.): 1380 VA

Ambient temperature: -25°C ... +55°C

Storage temperature: -25 °C ... + 70°C

Protection degree: IP40 (housing), IP20 (terminal strip)

In compliance with standards: 2006/42/EEC Machine Directive,

EN ISO 13849-1 (up to cat. 4 PL e), EN 50178:1997, EN 60947-5-3/

A1:2005, EN 61508-1:1998 (SIL CL 1-3), EN 61508-2:2000 (SIL CL

1-3), EN 61508-4:1998 (SIL CL 1-3), IEC 62061:2005 (SIL CL 3)



# Safety module CS AR-08

## Pin assignment

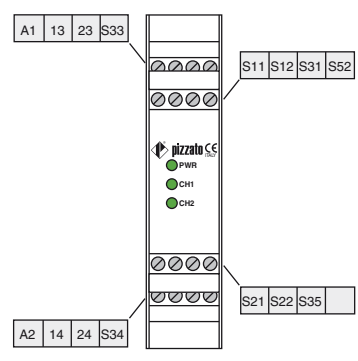

## Function diagrams

Configuration with automatic start

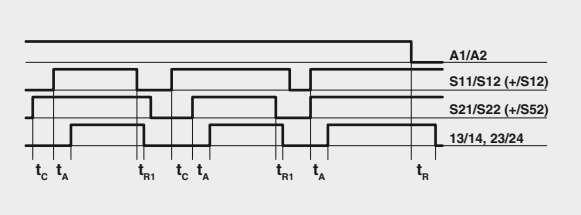

Configuration with monitored start

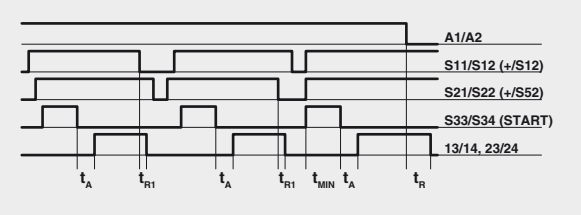

Configuration with manual start

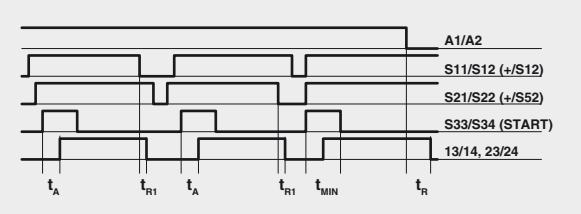

## Internal block diagram

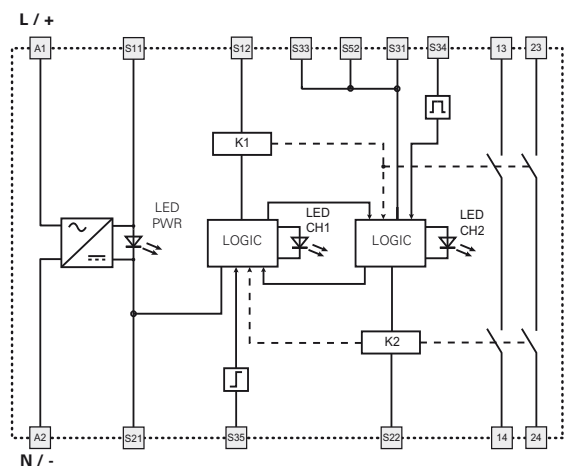

Legend:

- $t_{MIN}$ : Min. duration of start impulse
- $t_c$ : simultaneity time
- $t_A$ : response time
- $t_{R1}$ : release time
- $t_r$ : release time in absence of power supply

Notes:

The configurations with one channel are obtained taking into consideration the CH1 input only. In this case it is necessary to consider time  $t_{R1}$  referred to input CH1, time  $t_A$  referred to the supply, time  $t_A$  referred to input CH1 and to the start, and time  $t_{MIN}$  referred to the start.

## Input configuration

### Semiconductor outputs (e.g. light barriers)

#### Input configuration with manual start

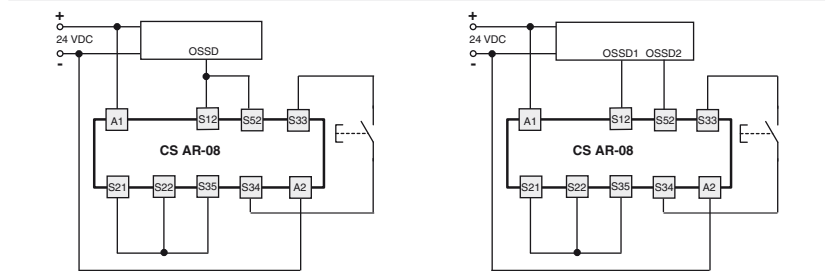

### Automatic start

With regard to the indicated diagrams, bridge the start button between S33 and S34 in order to activate the automatic start module.

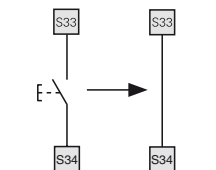

### Monitored start

With regard to the indicated diagrams, remove the connection between S22 and S35 in order to activate the monitored start module.

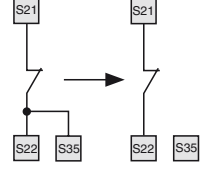

### Emergency stop circuits

#### Input configuration with manual start

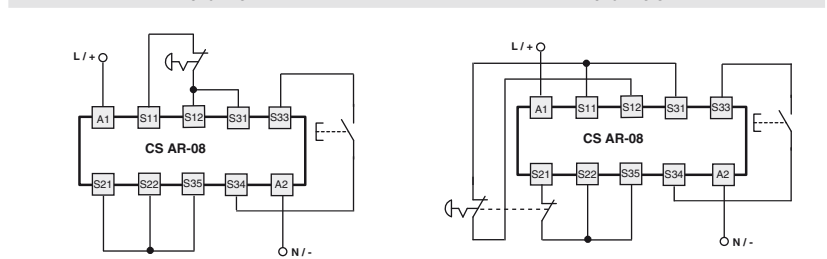

### Monitoring of movable guards and magnetic safety sensors

The safety module can monitor emergency stop circuits, control circuits for movable guards as well as magnetic safety sensors. Replace the emergency stop contacts with switch contacts or sensor contacts. The sensors can only be used in 2-channel configuration.

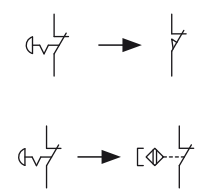

The diagram does not show the exact position of the terminals in the product

Items with code on green background are stock items

Application examples See page 251



### Module for emergency stops and end position monitoring for movable guards

#### Main features

- For safety applications up to SIL CL 3/PL e
- Input with 1 or 2 channels
- Choice between automatic start, manual start (CS AR-20 only) or monitored start (CS AR-21 only)
- Reduced housing width of 22.5 mm
- 2 NO safety contacts
- Supply voltage: 24 Vac/dc, 120 Vac, 230 Vac

#### Utilization categories

Alternating current: AC15 (50...60 Hz)

U<sub>e</sub> (V) 230

I<sub>e</sub> (A) 3

Direct current: DC13 (6 oper. cycles/min.)

U<sub>e</sub> (V) 24

I<sub>e</sub> (A) 4

#### Quality marks and certificates:



EC type examination certificate: IMQ CP 432 DM

UL approval: E131787

CCC approval: 2013010305640211

EAC approval: RU C-IT.AQ35.B.00454

#### Compliance with the requirements of:

Low Voltage Directive 2014/35/EU,

Machinery Directive 2006/42/EC,

EMC Directive 2014/30/EU

#### Technical data

##### Housing

Polyamide housing PA 66, self-extinguishing V0 acc. to UL 94

Protection degree:

IP40 (housing), IP20 (terminal strip)

Dimensions:

see page 295, design A

##### General data

SIL CL:

up to SIL CL 3 acc. to EN 62061

Performance Level (PL):

up to PL e acc. to EN ISO 13849-1

Safety category:

up to cat. 3 acc. to EN ISO 13849-1

Safety parameters:

see page 349

Ambient temperature:

-25°C...+55°C

Mechanical endurance:

>10 million operating cycles

Electrical endurance:

>100,000 operating cycles

Pollution degree:

external 3, internal 2

Impulse withstand voltage (U<sub>imp</sub>):

4 kV

Rated insulation voltage (U<sub>i</sub>):

250 V

Overvoltage category:

II

Weight:

0.2 kg

##### Supply

Rated supply voltage (U<sub>n</sub>):

24 Vac/dc; 50...60 Hz

120 Vac; 50...60 Hz

230 Vac; 50...60 Hz

Max. DC residual ripple in DC:

10%

Supply voltage tolerance:

±15% of U<sub>n</sub>

Power consumption AC:

< 5 VA

Power consumption DC:

< 2 W

##### Control circuit

Protection against short circuits:

PTC resistance, I<sub>h</sub>=0.5 A

PTC times:

Response time > 100 ms, release time > 3 s

Maximum resistance per input:

≤ 50 Ω

Current per input:

70 mA (typical)

Min. duration of start impulse t<sub>MIN</sub>:

> 100 ms

Response time t<sub>A</sub>:

< 50 ms

Release time in absence of power supply t<sub>R</sub>:

< 100 ms

Simultaneity time t<sub>c</sub>:

unlimited

##### In compliance with standards:

EN 60204-1, EN ISO 13855, EN 1037, EN ISO 12100, EN ISO 13850, EN 60529,

EN 61000-6-2, EN 61000-6-3, EN 61326-1, EN 60664-1, EN 60947-1, EN ISO 13849-1,

EN ISO 13849-2, EN 62061, UL 508, CSA C22.2 n° 14-95

##### Output circuit

Output contacts:

2 NO safety contacts

Contact type:

forcibly guided

Material of the contacts:

gold-plated silver alloy

Maximum switching voltage:

230/240 Vac; 300 Vdc

Max. current per contact:

6 A

Conventional free air thermal current (I<sub>th</sub>):

6 A

Max. total current Σ I<sub>th</sub><sup>2</sup>:

36 A<sup>2</sup>

Minimum current:

10 mA

Contact resistance:

≤ 100 mΩ

External protection fuse:

4 A

The number and the load capacity of output contacts can be increased by using expansion modules or contactors. see page 241-250.

#### Code structure

## CS AR-20V024

##### Start mode

**20** manual or automatic start

**21** monitored start

##### Connection type

**V** Screw terminals

**M** Connector with screw terminals

**X** Connector with spring terminals

##### Supply voltage

**024** 24 Vac/dc

**120** 120 Vac

**230** 230 Vac

#### Stock items

CS AR-20V024

#### Features approved by UL

Rated supply voltage (U<sub>n</sub>):

24 Vac/dc; 50...60 Hz

120 Vac; 50...60 Hz

230 Vac; 50...60 Hz

< 5 VA

Power consumption AC:

Power consumption DC:

Maximum switching voltage:

230 Vac

Max. current per contact:

6 A

Utilization category

C300

Notes:

- Use 60 or 75 °C copper (Cu) conductors, rigid or flexible, wire size 30-12 AWG.

- Tightening torque for terminal screws of 5-7 lb in.

- Only for 24 Vac/dc versions: power supply only with class 2 sources or with limited voltage and energy. (Supply from Remote Class 2 Source or limited voltage limited energy).



### Safety module CS AR-20 / CS AR-21

#### Pin assignment

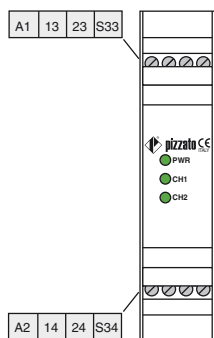

#### Internal block diagram

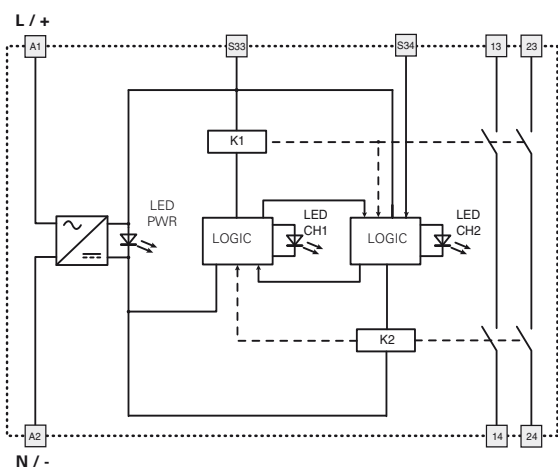

#### Function diagrams

Configuration with automatic start (CS AR-20)

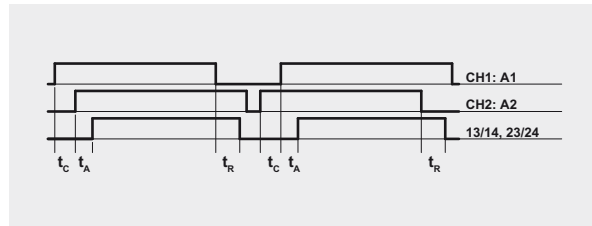

Configuration with monitored start (CS AR-21)

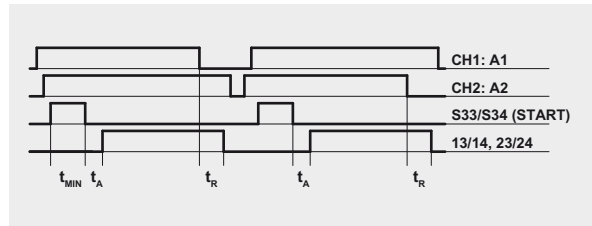

Configuration with manual start (CS AR-20)

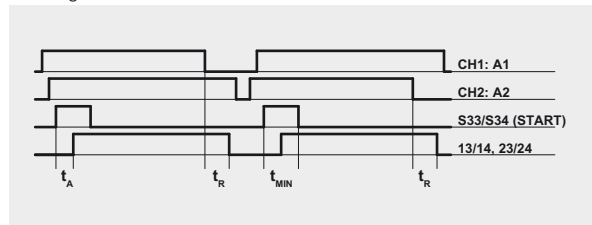

Legend: t\_MIN: Min. duration of start impulse, t\_A: response time, t\_c: simultaneity time, t\_R: release time in absence of power supply

Notes: The configurations with one channel are obtained taking into consideration the CH1:A1 input only. In this case it is necessary to consider time t\_R referred to input CH1:A1, time t\_A referred to input CH1:A1 and to the start, and time t\_MIN referred to the start.

#### Input configuration

Emergency stop circuits	
Input configuration with manual start	
1 channel	2 channels

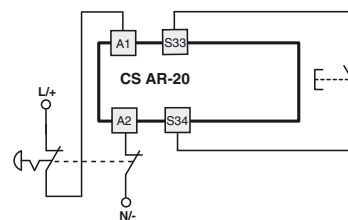
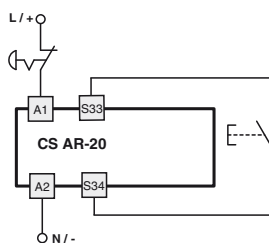

The diagram does not show the exact position of the terminals in the product

#### Automatic start

With regard to the indicated diagrams, bridge the start button between S33 and S34 in order to activate the automatic start module.

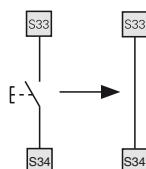

#### Monitored start

Use module CS AR-21 with the circuit diagrams for manual start.

#### Movable guard monitoring

The safety module can monitor emergency stop circuits and control circuits for movable guards. Replace the emergency stop contacts with the switch contacts.

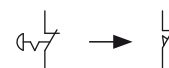

Items with code on green background are stock items

Application examples See page 251



### Module for emergency stops and end position monitoring for movable guards

#### Main features

- For safety applications up to SIL CL 3/PL e
- Input with 1 or 2 channels
- Choice between automatic start, manual start (CS AR-22 only) or monitored start (CS AR-23 only)
- Reduced housing width of 22.5 mm
- 3 NO safety contacts, 1 NC auxiliary contact
- Supply voltage: 24 Vac/dc, 120 Vac, 230 Vac

#### Utilization categories

Alternating current: AC15 (50...60 Hz)

U<sub>e</sub> (V) 230

I<sub>e</sub> (A) 3

Direct current: DC13 (6 oper. cycles/min.)

U<sub>e</sub> (V) 24

I<sub>e</sub> (A) 4

#### Quality marks and certificates:



EC type examination certificate: IMQ CP 432 DM

UL approval: E131787

CCC approval: 2013010305640211

EAC approval: RU C-IT.AQ35.B.00454

#### Compliance with the requirements of:

Low Voltage Directive 2014/35/EU,

Machinery Directive 2006/42/EC,

EMC Directive 2014/30/EU

#### Technical data

##### Housing

Polyamide housing PA 66, self-extinguishing V0 acc. to UL 94

Protection degree:

IP40 (housing), IP20 (terminal strip)

Dimensions:

see page 295, design A

##### General data

SIL CL:

up to SIL CL 3 acc. to EN 62061

Performance Level (PL):

up to PL e acc. to EN ISO 13849-1

Safety category:

up to cat. 3 acc. to EN ISO 13849-1

Safety parameters:

see page 349

Ambient temperature:

-25°C...+55°C

Mechanical endurance:

>10 million operating cycles

Electrical endurance:

>100,000 operating cycles

Pollution degree:

external 3, internal 2

Impulse withstand voltage (U<sub>imp</sub>):

4 kV

Rated insulation voltage (U<sub>i</sub>):

250 V

Overtoltage category:

II

Weight:

0.2 kg

##### Supply

Rated supply voltage (U<sub>n</sub>):

24 Vac/dc; 50...60 Hz

120 Vac; 50...60 Hz

230 Vac; 50...60 Hz

Max. DC residual ripple in DC:

10%

Supply voltage tolerance:

±15% of U<sub>n</sub>

Power consumption AC:

< 5 VA

Power consumption DC:

< 2 W

##### Control circuit

Protection against short circuits:

PTC resistance, I<sub>h</sub>=0.5 A

PTC times:

Response time > 100 ms, release time > 3 s

Maximum resistance per input:

≤ 50 Ω

Current per input:

70 mA (typical)

Min. duration of start impulse t<sub>MIN</sub>:

> 100 ms

Response time t<sub>A</sub>:

< 50 ms

Release time in absence of power supply t<sub>R</sub>:

< 75 ms

Simultaneity time t<sub>C</sub>:

unlimited

##### In compliance with standards:

EN 60204-1, EN ISO 13855, EN 1037, EN ISO 12100, EN ISO 13850, EN 60529,

EN 61000-6-2, EN 61000-6-3, EN 61326-1, EN 60664-1, EN 60947-1, EN ISO 13849-1,

EN ISO 13849-2, EN 62061, UL 508, CSA C22.2 n° 14-95

##### Output circuit

Output contacts:

3 NO safety contacts

1 NC auxiliary contact

forcibly guided

Contact type:

gold-plated silver alloy

Material of the contacts:

Maximum switching voltage:

230/240 Vac; 300 Vdc

Max. current per contact:

6 A

Conventional free air thermal current (I<sub>th</sub>):

6 A

Max. total current Σ I<sub>th</sub><sup>2</sup>:

80 A<sup>2</sup>

Minimum current:

10 mA

Contact resistance:

≤ 100 mΩ

External protection fuse:

4 A

The number and the load capacity of output contacts can be increased by using expansion modules or contactors. see page 241-250.

#### Code structure

## CS AR-22V024

##### Start mode

**22** manual or automatic start

**23** monitored start

##### Connection type

**V** Screw terminals

**M** Connector with screw terminals

**X** Connector with spring terminals

##### Supply voltage

**024** 24 Vac/dc

**120** 120 Vac

**230** 230 Vac

#### Stock items

CS AR-22V024

#### Features approved by UL

Rated supply voltage (U<sub>n</sub>): 24 Vac/dc; 50...60 Hz  
120 Vac; 50...60 Hz  
230 Vac; 50...60 Hz

Power consumption AC: < 5 VA

Power consumption DC: < 2 W

Maximum switching voltage: 230 Vac

Max. current per contact: 6 A

Utilization category: C300

Notes:

- Use 60 or 75 °C copper (Cu) conductors, rigid or flexible, wire size 30-12 AWG.

- Tightening torque for terminal screws of 5-7 lb in.

- Only for 24 Vac/dc versions: power supply only with class 2 sources or with limited voltage and energy. (Supply from Remote Class 2 Source or limited voltage limited energy).



### Safety module CS AR-22 / CS AR-23

#### Pin assignment

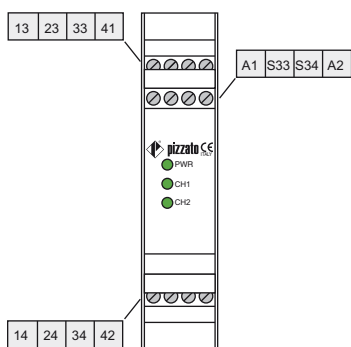

#### Internal block diagram

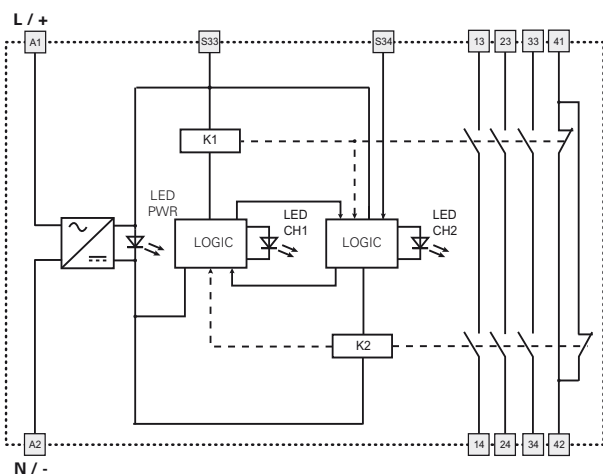

#### Input configuration

Emergency stop circuits	
Input configuration with manual start	
1 channel	2 channels

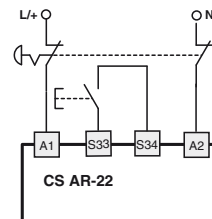
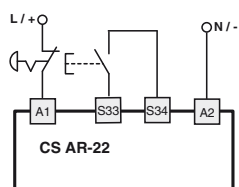

The diagram does not show the exact position of the terminals in the product

#### Automatic start

With regard to the indicated diagrams, bridge the start button between S33 and S34 in order to activate the automatic start module.

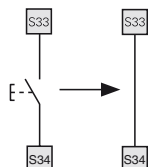

#### Monitored start

Use module CS AR-23 with the circuit diagrams for manual start.

#### Movable guard monitoring

The safety module can monitor emergency stop circuits and control circuits for movable guards. Replace the emergency stop contacts with the switch contacts.

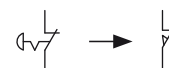

#### Function diagrams

Configuration with automatic start (CS AR-22)

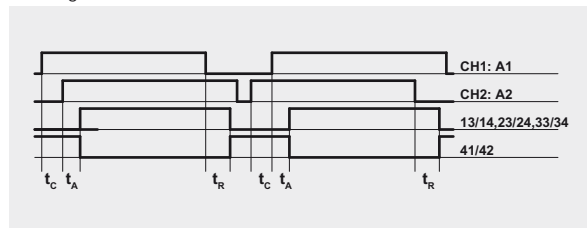

Configuration with monitored start (CS AR-23)

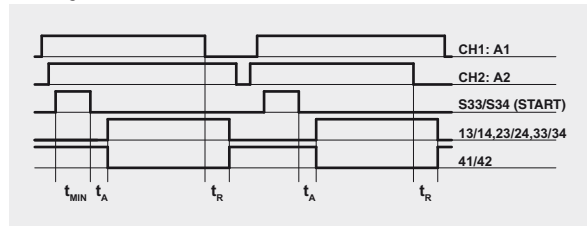

Configuration with manual start (CS AR-22)

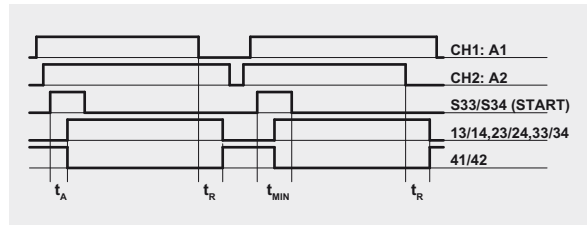

Legend:

- $t_{MIN}$ : Min. duration of start impulse
- $t_c$ : simultaneity time
- $t_A$ : response time
- $t_R$ : release time in absence of power supply

Notes:

The configurations with one channel are obtained taking into consideration the CH1:A1 input only. In this case it is necessary to consider time  $t_R$  referred to input CH1:A1, time  $t_A$  referred to input CH1:A1 and to the start, and time  $t_{MIN}$  referred to the start.





### Module for emergency stops and end position monitoring for movable guards

#### Main features

- For safety applications up to SIL CL 3/PL e
- Input with 1 or 2 channels
- Choice between automatic start, manual start (CS AR-24 only) or monitored start (CS AR-25 only)
- Reduced housing width of 22.5 mm
- 4 NO safety contacts
- 1 NC auxiliary contact
- Supply voltage: 24 Vac/dc

#### Utilization categories

Alternating current: AC15 (50...60 Hz)

U<sub>e</sub> (V) 230

I<sub>e</sub> (A) 3

Direct current: DC13 (6 oper. cycles/min.)

U<sub>e</sub> (V) 24

I<sub>e</sub> (A) 4

#### Quality marks and certificates:



EC type examination certificate: IMQ CP 432 DM

UL approval: E131787

CCC approval: 2013010305640211

EAC approval: RU C-IT.AQ35.B.00454

#### Compliance with the requirements of:

Low Voltage Directive 2014/35/EU,

Machinery Directive 2006/42/EC,

EMC Directive 2014/30/EU

#### Technical data

##### Housing

Polyamide housing PA 66, self-extinguishing V0 acc. to UL 94

Protection degree:

IP40 (housing), IP20 (terminal strip)

Dimensions:

see page 295, design A

##### General data

SIL CL:

up to SIL CL 3 acc. to EN 62061

Performance Level (PL):

up to PL e acc. to EN ISO 13849-1

Safety category:

up to cat. 3 acc. to EN ISO 13849-1

Safety parameters:

see page 349

Ambient temperature:

-25°C...+55°C

Mechanical endurance:

>10 million operating cycles

Electrical endurance:

>100,000 operating cycles

Pollution degree:

external 3, internal 2

Impulse withstand voltage (U<sub>imp</sub>):

4 kV

Rated insulation voltage (U<sub>i</sub>):

250 V

Overtoltage category:

II

Weight:

0.3 kg

##### Supply

Rated supply voltage (U<sub>n</sub>):

24 Vac/dc; 50...60 Hz

Max. DC residual ripple in DC:

10%

Supply voltage tolerance:

±15% of U<sub>n</sub>

Power consumption AC:

< 5 VA

Power consumption DC:

< 2 W

##### Control circuit

Protection against short circuits:

PTC resistance, I<sub>h</sub>=0.5 A

PTC times:

Response time > 100 ms, release time > 3 s

Maximum resistance per input:

≤ 50 Ω

Current per input:

30 mA (typical)

Min. duration of start impulse t<sub>MIN</sub>:

> 100 ms

Response time t<sub>A</sub>:

< 100 ms

Release time t<sub>R1</sub>:

< 40 ms

Release time in absence of power supply t<sub>R</sub>:

< 170 ms

Simultaneity time t<sub>C</sub>:

unlimited

##### In compliance with standards:

EN 60204-1, EN ISO 13855, EN 1037, EN ISO 12100, EN ISO 13850, EN 60529,

EN 61000-6-2, EN 61000-6-3, EN 61326-1, EN 60664-1, EN 60947-1, EN ISO 13849-1,

EN ISO 13849-2, EN 62061, UL 508, CSA C22.2 n° 14-95

##### Output circuit

Output contacts:

4 NO safety contacts

1 NC auxiliary contact

forcibly guided

Contact type:

Material of the contacts:

gold-plated silver alloy

Maximum switching voltage:

230/240 Vac; 300 Vdc

Max. current per contact:

6 A

Conventional free air thermal current (I<sub>th</sub>):

6 A

Max. total current Σ I<sub>th</sub><sup>2</sup>:

72 A<sup>2</sup>

Minimum current:

10 mA

Contact resistance:

≤ 100 mΩ

External protection fuse:

4 A

The number and the load capacity of output contacts can be increased by using expansion modules or contactors. see page 241-250.

#### Code structure

## CS AR-24V024

##### Start mode

**24** manual or automatic start

**25** monitored start

##### Connection type

**V** Screw terminals

**M** Connector with screw terminals

**X** Connector with spring terminals

##### Supply voltage

**024** 24 Vac/dc

##### Features approved by UL

Rated supply voltage (U<sub>n</sub>): 24 Vac/dc; 50...60 Hz

Power consumption AC: < 5 VA

Power consumption DC: < 2 W

Maximum switching voltage: 230 Vac

Max. current per contact: 6 A

Utilization category: C300

##### Notes:

- Use 60 or 75 °C copper (Cu) conductors, rigid or flexible, wire size 30-12 AWG.
- Tightening torque for terminal screws of 5-7 lb in.
- Only for 24 Vac/dc versions: power supply only with class 2 sources or with limited voltage and energy. (Supply from Remote Class 2 Source or limited voltage limited energy).



### Safety module CS AR-24 / CS AR-25

#### Pin assignment

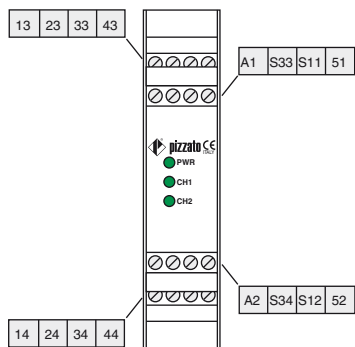

#### Function diagrams

Configuration with automatic start (CS AR-24)

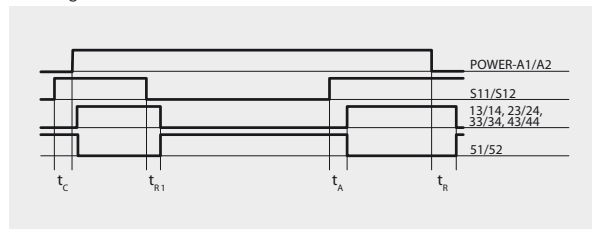

Configuration with monitored start (CS AR-25)

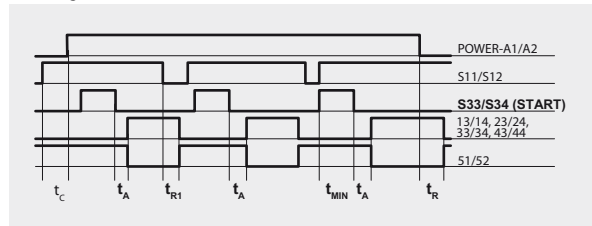

#### Internal block diagram

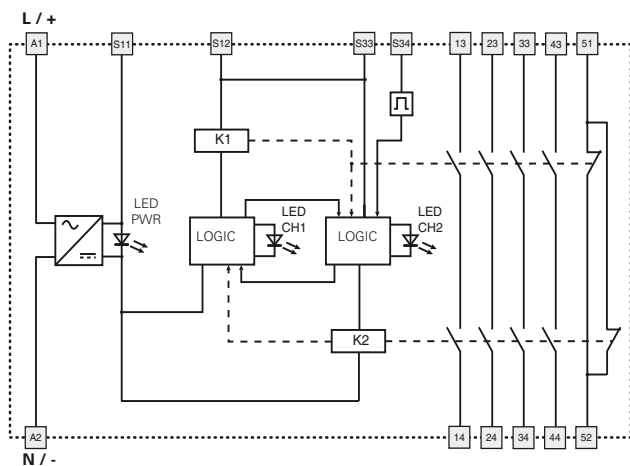

Configuration with manual start (CS AR-24)

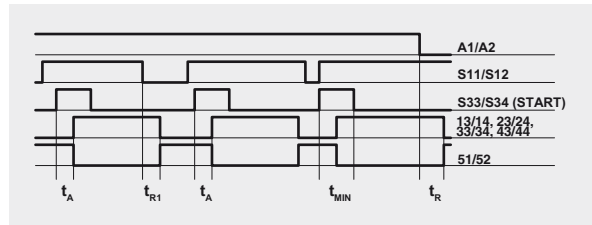

- Legend:
- $t_{MIN}$ : Min. duration of start impulse
  - $t_c$ : simultaneity time
  - $t_A$ : response time
  - $t_r$ : release time
  - $t_{r1}$ : release time in absence of power supply

Notes:  
The configurations with one channel are obtained taking into consideration the S11/S12 input only. In this case it is necessary to consider time  $t_{r1}$  referred to input S11/S12, time  $t_r$  referred to the supply, time  $t_A$  referred to input S11/S12 and to the start, and time  $t_{MIN}$  referred to the start.

#### Input configuration

Emergency stop circuits	
Input configuration with manual start	
1 channel	2 channels

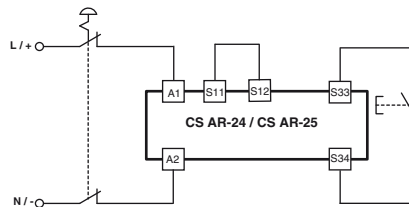
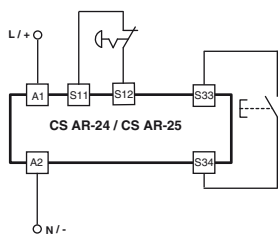

The diagram does not show the exact position of the terminals in the product

#### Automatic start

With regard to the indicated diagrams, bridge the start button between S33 and S34 in order to activate the automatic start module.

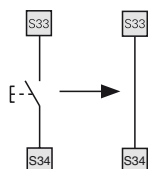

#### Monitored start

Use module CS AR-25 with the circuit diagrams for manual start.

#### Movable guard monitoring

The safety module can monitor emergency stop circuits and control circuits for movable guards. Replace the emergency stop contacts with the switch contacts.

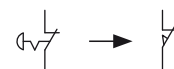

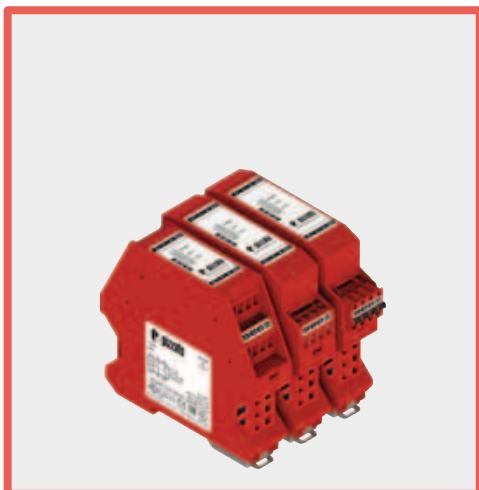

**Module for emergency stops and end position monitoring for movable guards**

#### Main features

- For safety applications up to SIL CL 2/PL d
- Choice between automatic start, manual start (CS AR-40 only) or monitored start (CS AR-41 only)
- Reduced housing width of 22.5 mm
- 2 NO safety contacts
- Supply voltage: 24 Vac/dc

#### Utilization categories

Alternating current: AC15 (50...60 Hz)

U<sub>e</sub> (V) 230

I<sub>e</sub> (A) 3

Direct current: DC13 (6 oper. cycles/min.)

U<sub>e</sub> (V) 24

I<sub>e</sub> (A) 4

#### Quality marks and certificates:



EC type examination certificate: IMQ CP 432 DM

UL approval: E131787

CCC approval: 2013010305640211

EAC approval: RU C-IT.A.35.B.00454

#### Compliance with the requirements of:

Low Voltage Directive 2014/35/EU,

Machinery Directive 2006/42/EC,

EMC Directive 2014/30/EU

#### Technical data

##### Housing

Polyamide housing PA 66, self-extinguishing V0 acc. to UL 94

Protection degree:

IP40 (housing), IP20 (terminal strip)

Dimensions:

see page 296, design D

##### General data

SIL CL:

up to SIL CL 2 acc. to EN 62061

Performance Level (PL):

up to PL d acc. to EN ISO 13849-1

Safety category:

up to cat. 2 acc. to EN ISO 13849-1

Safety parameters:

see page 349

Ambient temperature:

-25°C...+55°C

Mechanical endurance:

>10 million operating cycles

Electrical endurance:

>100,000 operating cycles

Pollution degree:

external 3, internal 2

Impulse withstand voltage (U<sub>imp</sub>):

4 kV

Rated insulation voltage (U<sub>i</sub>):

250 V

Overvoltage category:

II

Weight:

0.2 kg

##### Supply

Rated supply voltage (U<sub>n</sub>):

24 Vac/dc; 50...60 Hz

Max. DC residual ripple in DC:

10%

Supply voltage tolerance:

±15% of U<sub>n</sub>

Power consumption AC:

< 5 VA

Power consumption DC:

< 2 W

##### Control circuit

Protection against short circuits:

PTC resistance, I<sub>h</sub>=0.5 A

PTC times:

Response time > 100 ms, release time > 3 s

Maximum resistance per input:

≤ 50 Ω

Current per input:

70 mA (typical)

Min. duration of start impulse t<sub>MIN</sub>:

> 100 ms

Response time t<sub>A</sub>:

< 50 ms

Release time in absence of power supply t<sub>R</sub>:

< 105 ms

Simultaneity time t<sub>C</sub>:

unlimited

##### In compliance with standards:

EN 60204-1, EN ISO 13855, EN 1037, EN ISO 12100, EN ISO 13850, EN 60529,

EN 61000-6-2, EN 61000-6-3, EN 61326-1, EN 60664-1, EN 60947-1, EN ISO 13849-1,

EN ISO 13849-2, EN 62061, UL 508, CSA C22.2 n° 14-95

##### Output circuit

Output contacts:

2 NO safety contacts

Contact type:

forcibly guided

Material of the contacts:

silver alloy

Maximum switching voltage:

230/240 Vac; 300 Vdc

Max. current per contact:

6 A

Conventional free air thermal current (I<sub>th</sub>):

6 A

Max. total current Σ I<sub>th</sub><sup>2</sup>:

36 A<sup>2</sup>

Minimum current:

10 mA

Contact resistance:

≤ 100 mΩ

External protection fuse:

4 A

The number and the load capacity of output contacts can be increased by using expansion modules or contactors. see page 241-250.

#### Code structure

## CS AR-40V024

##### Start mode

**40** manual or automatic start

**41** monitored start

##### Connection type

**V** Screw terminals

**M** Connector with screw terminals

**X** Connector with spring terminals

##### Supply voltage

**024** 24 Vac/dc

#### Stock items

CS AR-40V024

#### Features approved by UL

Rated supply voltage (U<sub>n</sub>): 24 Vac/dc; 50...60 Hz

Power consumption AC: < 5 VA

Power consumption DC: < 2 W

Maximum switching voltage: 230 Vac

Max. current per contact: 6 A

Utilization category: C300

##### Notes:

- Use 60 or 75 °C copper (Cu) conductors, rigid or flexible, wire size 30-12 AWG.

- Tightening torque for terminal screws of 5-7 lb in.

- Only for 24 Vac/dc versions: power supply only with class 2 sources or with limited voltage and energy. (Supply from Remote Class 2 Source or limited voltage limited energy).



### Safety module CS AR-40 / CS AR-41

#### Pin assignment

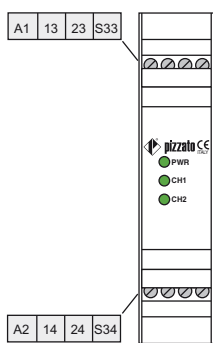

#### Internal block diagram

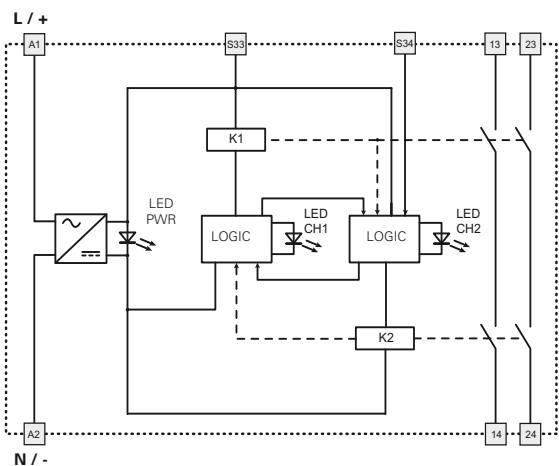

#### Function diagrams

1-channel configuration with automatic start (CS AR-40)

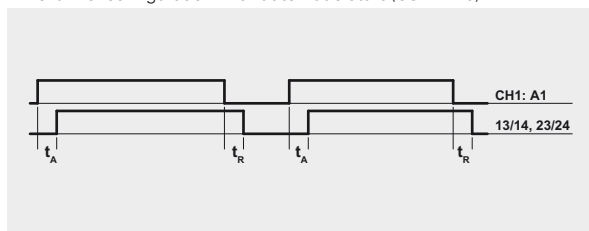

1-channel configuration with manual start (CS AR-40)



1-channel configuration with monitored start (CS AR-41)

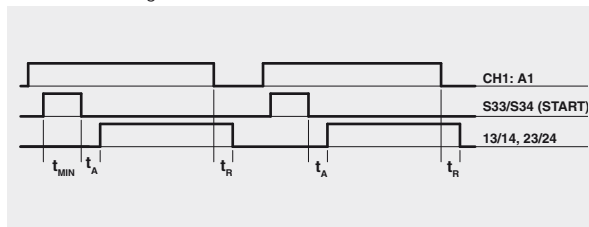

Legend:  
t<sub>MIN</sub>: Min. duration of start impulse  
t<sub>A</sub>: response time  
t<sub>R</sub>: release time in absence of power supply

#### Input configuration

Emergency stop circuits
One channel input configuration with manual start

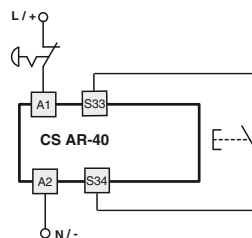

The diagram does not show the exact position of the terminals in the product

#### Automatic start

With regard to the indicated diagram, bridge the start button between S33 and S34 in order to activate the automatic start module.

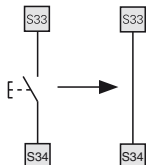

#### Monitored start

Use module CS AR-41 with the circuit diagrams for manual start.

#### Movable guard monitoring

The safety module can monitor emergency stop circuits and control circuits for movable guards. Replace the emergency stop contacts with the switch contacts.

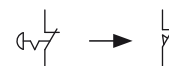

Items with code on **green** background are stock items

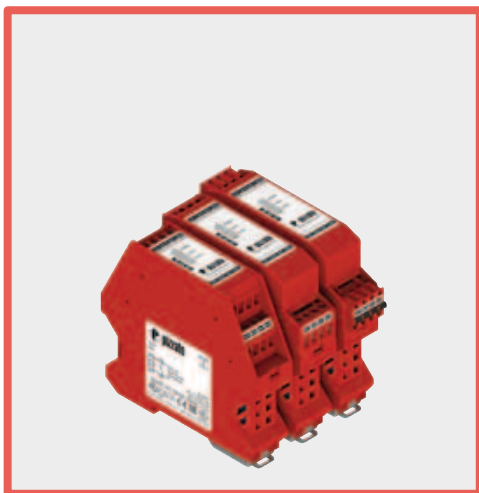

### Module for emergency stop, end position monitoring for movable guards, and magnetic safety sensors and devices

#### Main features

- For safety applications up to SIL CL 1/PL c
- Reduced housing width of 22.5 mm
- 1 NO safety contact
- Supply voltage: 24 Vac/dc

#### Utilization categories

Alternating current: AC15 (50...60 Hz)

U<sub>e</sub> (V) 230

I<sub>e</sub> (A) 3

Direct current: DC13 (6 oper. cycles/min.)

U<sub>e</sub> (V) 24

I<sub>e</sub> (A) 4

#### Quality marks and certificates:



EC type examination certificate: IMQ CP 432 DM

UL approval: E131787

CCC approval: 2013010305640211

EAC approval: RU C-IT.AД35.B.00454

#### Compliance with the requirements of:

Low Voltage Directive 2014/35/EU,

Machinery Directive 2006/42/EC,

EMC Directive 2014/30/EU

#### Technical data

##### Housing

Polyamide housing PA 66, self-extinguishing V0 acc. to UL 94

Protection degree:

IP40 (housing), IP20 (terminal strip)

Dimensions:

see page 296, design D

##### General data

SIL CL:

up to SIL CL 1 acc. to EN 62061

Performance Level (PL):

up to PL c acc. to EN ISO 13849-1

Safety category:

up to cat. 1 acc. to EN ISO 13849-1

Safety parameters:

see page 349

Ambient temperature:

-25°C...+55°C

Mechanical endurance:

>10 million operating cycles

Electrical endurance:

>100,000 operating cycles

Pollution degree:

external 3, internal 2

Impulse withstand voltage (U<sub>imp</sub>):

4 kV

Rated insulation voltage (U<sub>i</sub>):

250 V

Oversvoltage category:

II

Weight:

0.2 kg

##### Supply

Rated supply voltage (U<sub>n</sub>):

24 Vac/dc; 50...60 Hz

Max. DC residual ripple in DC:

10%

Supply voltage tolerance:

±15% of U<sub>n</sub>

Power consumption AC:

< 5 VA

Power consumption DC:

< 2 W

##### Control circuit

Protection against short circuits:

PTC resistance, I<sub>h</sub>=0.5 A

PTC times:

Response time > 100 ms, release time > 3 s

Maximum resistance per input:

≤ 50 Ω

Current per input:

20 mA (typical)

Response time t<sub>A</sub>:

< 15 ms

Release time t<sub>R1</sub>:

< 20 ms

Release time in absence of power supply t<sub>R2</sub>:

< 100 ms

Simultaneity time t<sub>c</sub>:

unlimited

##### In compliance with standards:

EN 60204-1, EN ISO 13855, EN 1037, EN ISO 12100, EN ISO 13850, EN 60529,

EN 61000-6-2, EN 61000-6-3, EN 61326-1, EN 60664-1, EN 60947-1, EN ISO 13849-1,

EN ISO 13849-2, EN 62061, UL 508, CSA C22.2 n° 14-95

##### Output circuit

Output contacts:

1 NO safety contact

Material of the contacts:

silver alloy

Maximum switching voltage:

230/240 Vac; 300 Vdc

Max. current per contact:

6 A

Conventional free air thermal current (I<sub>th</sub>):

6 A

Minimum current:

10 mA

Contact resistance:

≤ 100 mΩ

External protection fuse:

4 A

The number and the load capacity of output contacts can be increased by using expansion modules or contactors. see page 241-250.

#### Code structure

## CS AR-46V024

##### Connection type

**V** Screw terminals

**M** Connector with screw terminals

**X** Connector with spring terminals

##### Supply voltage

**024** 24 Vac/dc

#### Stock items

CS AR-46V024

#### Features approved by UL

Rated supply voltage (U<sub>n</sub>): 24 Vac/dc; 50...60 Hz

Power consumption AC: < 5 VA

Power consumption DC: < 2 W

Maximum switching voltage: 230 Vac

Max. current per contact: 6 A

Utilization category: C300

#### Notes:

- Use 60 or 75 °C copper (Cu) conductors, rigid or flexible, wire size 30-12 AWG.

- Tightening torque for terminal screws of 5-7 lb in.

- Only for 24 Vac/dc versions: power supply only with class 2 sources or with limited voltage and energy. (Supply from Remote Class 2 Source or limited voltage limited energy).



# Safety module CS AR-46

## Pin assignment

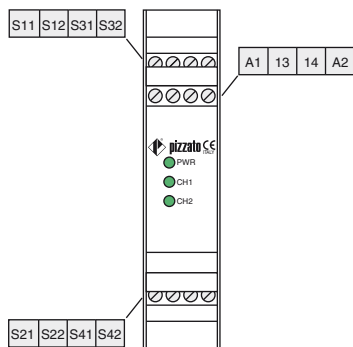

## Function diagrams

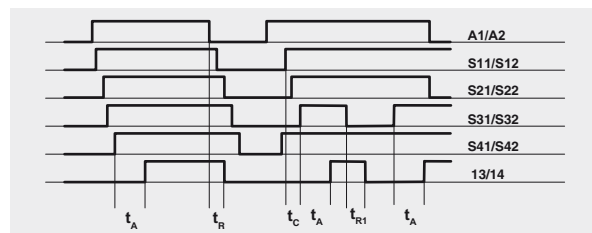

Legend:  
 $t_C$ : simultaneity time  
 $t_A$ : response time  
 $t_{R1}$ : release time  
 $t_A''$ : release time in absence of power supply

## Internal block diagram

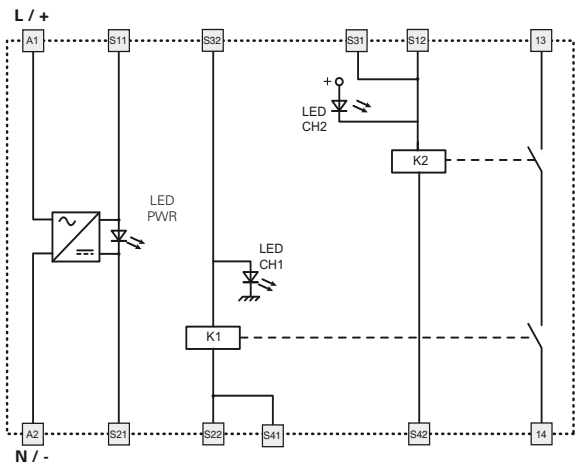

## Input configuration

Emergency stop circuits		
Input configuration with automatic start		
2 channels and 1 emergency button	2 channels and 2 emergency buttons	2 channels and 4 switches

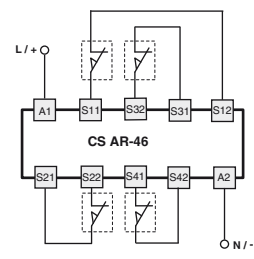
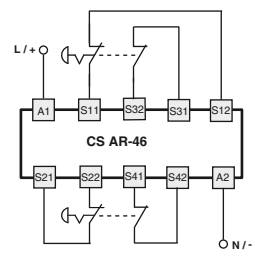
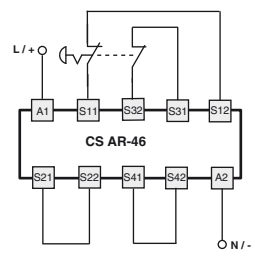

### 1 channel and 1 emergency button

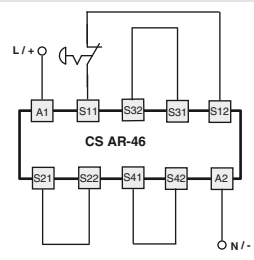

## Monitoring of movable guards and magnetic safety sensors

The safety module can monitor emergency stop circuits, control circuits for movable guards as well as magnetic safety sensors. Replace the emergency stop contacts with switch contacts or sensor contacts. The sensors can only be used in 2-channel configuration.

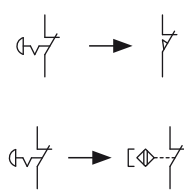

Items with code on **green** background are stock items



### Module for emergency stops, end position monitoring for movable guards and magnetic safety sensors

#### Main features

- For safety applications up to SIL 3/PL e
- Choice between automatic start, manual start or monitored start
- Connection of input channels of opposite potentials
- Reduced housing width of 22.5 mm
- Output contacts:  
2 NO safety contacts, 1 NO opto-decoupled auxiliary contact
- Supply voltage: 24 Vac/dc
- Insensitive to voltage dips

#### Utilization categories

Alternating current: AC15 (50...60 Hz)

U<sub>e</sub> (V) 230

I<sub>e</sub> (A) 3

Direct current: DC13 (6 oper. cycles/min.)

U<sub>e</sub> (V) 24

I<sub>e</sub> (A) 4

#### Quality marks and certificates:



IMQ certificate of conformity no. 340

(EN 81-20:2014; EN 81-50:2014; EN 81-1:1998+A3:2009;

EN 81-2:1998+A3:2009)

EC type examination certificate: IMQ CP 432 DM

(Machinery Directive)

EC type examination certificate: IMQ 236

(Machinery Directive)

CCC approval: 2013010305640211

EAC approval: RU C-IT.AQ35.B.00454

#### Compliance with the requirements of:

Low Voltage Directive 2014/35/EU,

Machinery Directive 2006/42/EC,

EMC Directive 2014/30/EU

### Technical data

#### Housing

Polyamide housing PA 66, self-extinguishing V0 acc. to UL 94

Protection degree:

IP40 (housing), IP20 (terminal strip)

Dimensions:

see page 295, design A

#### General data

SIL CL:

up to SIL CL 3 acc. to EN 62061

Performance Level (PL):

up to PL e acc. to EN ISO 13849-1

Safety category:

up to cat. 4 acc. to EN ISO 13849-1

Safety parameters:

see page 349

Ambient temperature:

-25°C...+55°C

Mechanical endurance:

>10 million operating cycles

Electrical endurance:

>100,000 operating cycles

Pollution degree:

external 3, internal 2

Impulse withstand voltage (U<sub>imp</sub>):

4 kV

Rated insulation voltage (U<sub>i</sub>):

250 V

Overvoltage category:

II

Weight:

0.2 kg

#### Supply

Rated supply voltage (U<sub>n</sub>):

24 Vac/dc; ±15%; 50...60 Hz

Max. DC residual ripple in DC:

10%

Power consumption AC:

< 5 VA

Power consumption DC:

< 2.5 W

#### Control circuit

Protection against short circuits:

PTC resistance, I<sub>h</sub>=0.5 A

PTC response time:

Response time > 100 ms, release time > 3 s

Maximum resistance per input:

≤ 50 Ω

Current per input:

< 40 mA

Min. duration of start impulse t<sub>MIN</sub>:

> 50 ms

Response time t<sub>A</sub>:

< 120 ms

Release time t<sub>R1</sub>:

< 15 ms

Release time in absence of power supply t<sub>R</sub>:

< 65 ms

Simultaneity time t<sub>c</sub>:

unlimited

Response time starting from application of the supply: < 300 ms

#### Auxiliary signalling circuit

Auxiliary output (Y43-Y44):

1NO opto-decoupled

Rated operating voltage (U<sub>o</sub>):

24 Vdc

Rated operating current (I<sub>o</sub>):

25 mA

Rated impulse withstand voltage (U<sub>imp</sub>):

4 kV

Release time t<sub>R2</sub>:

< 1 ms

#### In compliance with standards:

EN 60204-1, EN ISO 13855, EN 1037, EN ISO 12100, EN ISO 13850, EN 60529,

EN 61000-6-2, EN 61000-6-3, EN 61326-1, EN 60664-1, EN 60947-1, EN ISO 13849-1,

EN ISO 13849-2, EN 62061, UL 508, CSA C22.2 n° 14-95

#### Output circuit

Output contacts:

2 NO safety contacts,

Contact type:

forcibly guided

Material of the contacts:

gold-plated silver alloy

Maximum switching voltage:

230/240 Vac; 300 Vdc

Max. current per contact:

6 A

Conventional free air thermal current (I<sub>th</sub>):

6 A

Max. total current Σ I<sub>th</sub><sup>2</sup>:

36 A<sup>2</sup>

Minimum current:

10 mA

Contact resistance:

≤ 100 mΩ

External protection fuse:

4 A type F

The number and the load capacity of output contacts can be increased by using expansion modules or contactors. See page 241-250.

### Code structure

## CS AR-91V024

#### Connection type

V	Screw terminals
M	Connector with screw terminals
X	Connector with spring terminals

#### Supply voltage

024 24 Vac/dc

### Features approved by UL

Rated supply voltage (U <sub>n</sub> ):	24 Vac/dc; 50...60 Hz
Power consumption AC:	< 5 VA
Power consumption DC:	< 2.5 W
Maximum switching voltage:	230 Vac
Max. current per contact:	6 A
Utilization category	C300

Notes:  
 - Use 60 or 75 °C copper (Cu) conductors, rigid or flexible, wire size 30-12 AWG.  
 - Tightening torque for terminal screws of 5-7 lb in.  
 - Only for 24 Vac/dc versions: power supply only with class 2 sources or with limited voltage and energy. (Supply from Remote Class 2 Source or limited voltage limited energy).



### Safety module CS AR-91

#### Pin assignment

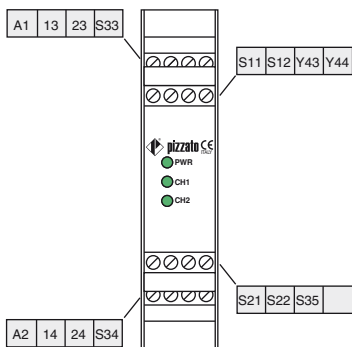

#### Voltage dips, short interruptions and voltage variations

The CS AR-91 safety module has a built-in voltage drop sensor which serves to protect and safeguard the internal state of the safety relays, in the event of dips or short voltage interruptions. This is to prevent unwanted switching states in relation to the state of the inputs from occurring. When voltage is restored, the device continues to operate with a switching state that is consistent with the input signals. The safety module retains its normal function during voltage dips and brief interruptions; for longer voltage interruptions, the safety outputs open and reset themselves automatically during an automatic start if voltage is restored or – in the case of a manual or monitored start – require that the system be reset by the operator.

#### Function diagrams

Configuration with automatic start

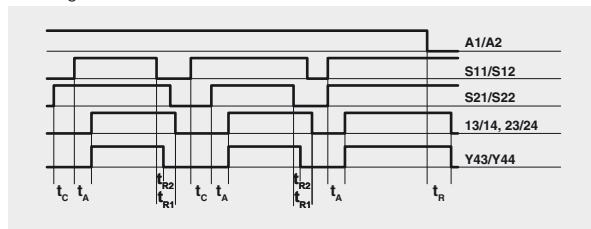

Configuration with monitored start

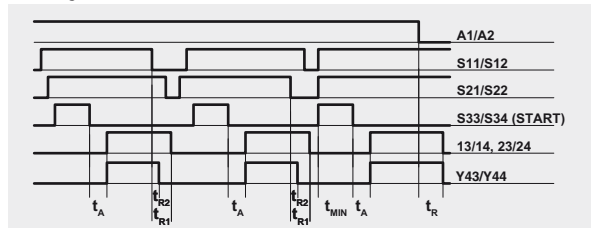

Configuration with manual start

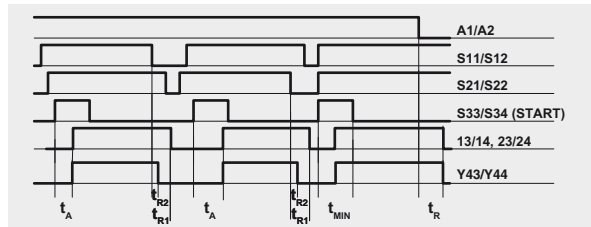

Legend:  
 $t_{MIN}$ : Min. duration of start impulse  
 $t_{R1}$ : release time  
 $t_{R2}$ : release time in absence of power supply  
 $t_C$ : simultaneity time  
 $t_A$ : response time

Notes:  
 The configurations with one channel are obtained taking into consideration the S11/ S12 input only. In this case it is necessary to consider time  $t_{R1}$  referred to input S11/S12, time  $t_R$  referred to the supply, time  $t_A$  referred to input S11/S12 and to the start, and time  $t_{MIN}$  referred to the start.

#### Internal block diagram

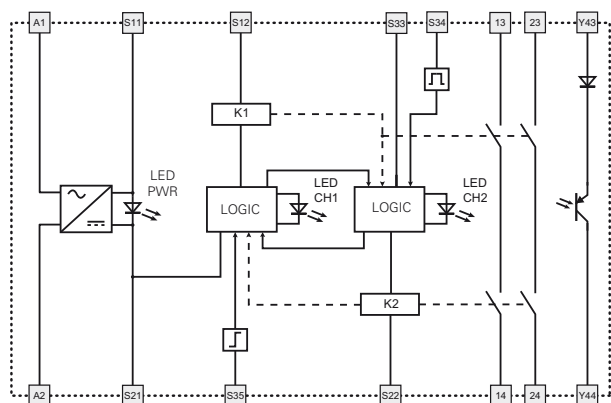

#### Input configuration

#### Input configuration with magnetic sensors

2 channels

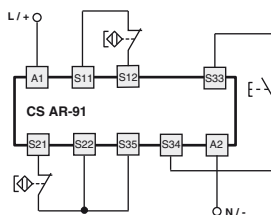

The diagram does not show the exact position of the terminals in the product

#### Automatic start

With regard to the indicated diagrams, bridge the start button between S33 and S34 in order to activate the automatic start module.

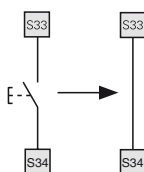

#### Monitored start

With regard to the indicated diagrams, remove the connection between S22 and S35 in order to activate the monitored start module.

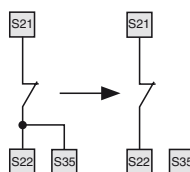

#### Monitoring of movable guards and magnetic safety sensors

The safety module can monitor emergency stop circuits, control circuits for movable guards as well as magnetic safety sensors. Replace the emergency stop contacts with switch contacts or sensor contacts. The sensors can only be used in 2-channel configuration.

