

Standard Cylinder Series

SZ 160

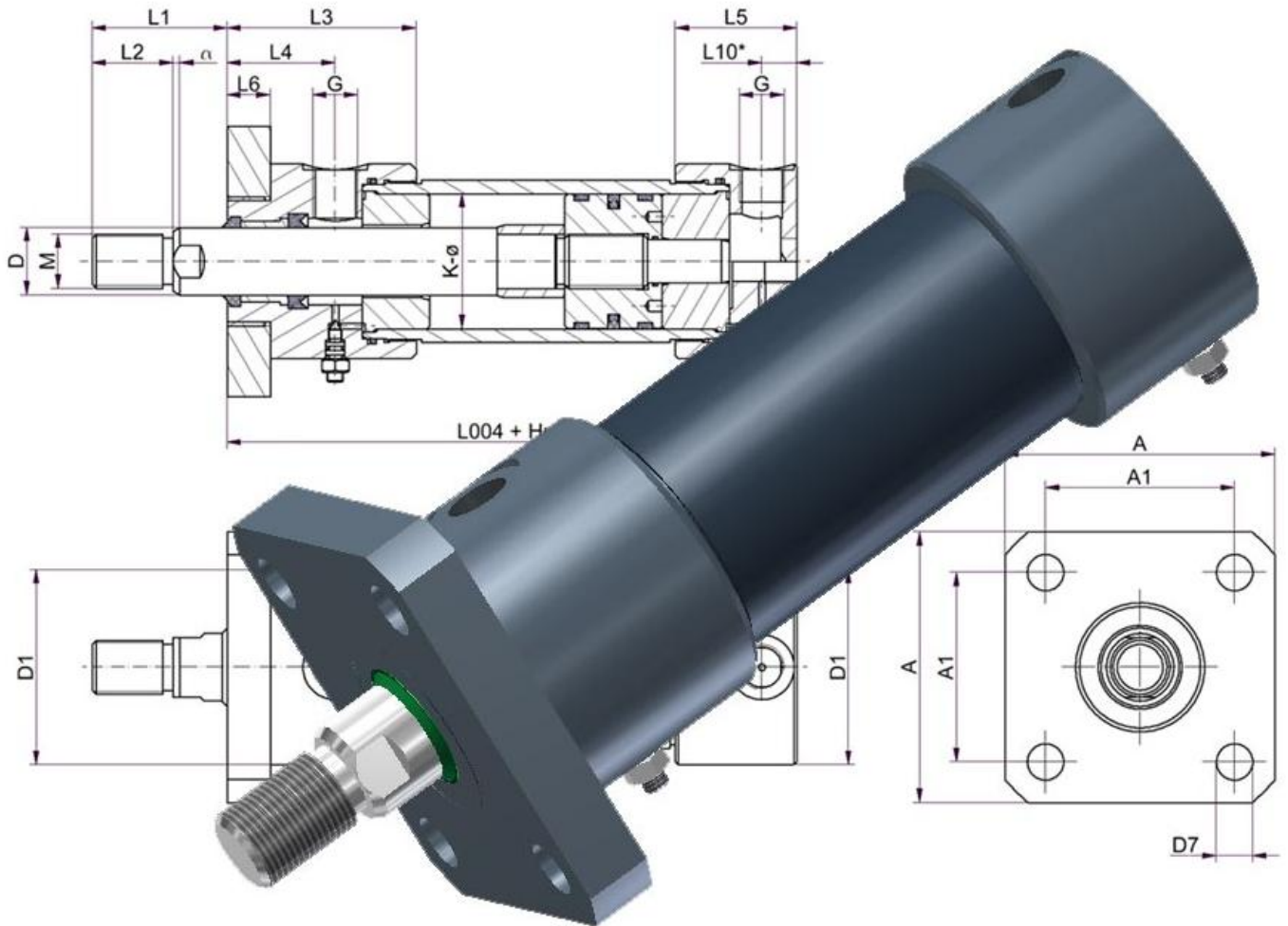
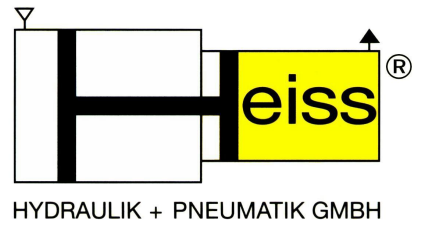

- Maximum operating pressure up to 160 bar
- Choice of 13 different piston sizes between 12 und 200mm and 23 different attachments
- Rugged yet compact design with good guiding properties
- Seal arrangement for easy service
- Seal groove and diameter according to ISO 5597/1 and DIN ISO 7425/1
- Seals by default for maximum continuous duty temperatures $\leq 80^{\circ}\text{C}$ and velocities $\leq 0,5 \text{ m/s}$
- Available for use with water

MANAGEMENTSYSTEM



DQS-zertifiziert nach
DIN EN ISO 9001
DIN EN ISO 14001



Reg.-Nr. 4744-01
Reg.-Nr. 14 4744-02

Table of contents:

General information / Technical specifications	2
Overview of attachment methods	3
Overview of functional modes	6
Dimension data sheets of configurations	7
Piston force diagram	30
Load/buckling diagram	31
Type designation	32

General information:

The cylinders are manufactured for the below listed applications in threaded design with ground and hard-chrome plated cylinder rods.

Special purpose designs of almost any kind can be considered. Intermediate sizes or piston sizes up to 500mm diameter are possible.

Cylinders can be fitted with vent valves upon request. Please indicate the desired location for the vent when ordering.

Please request our electronic product catalogue for CAD data or download it from www.heiss.de.

Technical specifications:

Operating pressure:

Maximum 160 bar, for higher operating pressures please contact us.

Operating fluids:

Hydraulic oil on the basis of mineral oils for example H, HL, HLP-oils per DIN 51524/51525. Other operating fluids like fire resisting fluids or water are possible upon request.

Operating temperature:

By default the cylinder is fitted with seals for a temperature range from -20°C to +80°C. High temperature resistant seals can be fitted without changes in design.

Piston travel speed:

Maximum 0,5 m/s. Please contact us for higher piston travel speeds.

Cylinder stroke:

The maximum permissible stroke is dependent on the permissible buckling stress. For dimensioning help please use the load/buckling diagram with the simplified calculation formulas.

Position of connections:

By default the bottom ports are concentric except with configurations 111-2, 116, 117, 118 to 225. Should the port be positioned radially, please, indicate this with the order.

Cylinders with dampers have the adjustment screw positioned across the port (Pos. 3) except with configuration 113, 113-1 and 113-2, here the adjustment screw is rotated by 90° away from the port when looking at the face of the piston rod end (Pos. 2).

Pos. 1 is the port position for all configurations. Should a different port position be required please indicate this with the order.

Example in combination with various attachments:

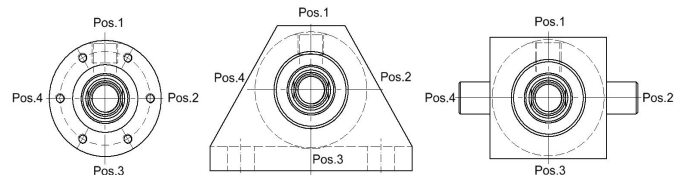

For port position rotated by 90° in clockwise direction please indicate with order "hydraulic port in Pos. 2".

Tolerances:

Tolerances for stroke and stroke dependent dimensions according to DIN ISO 2768 - g T1 (previously DIN 7168 - g)

Other tolerances according to DIN ISO 2768 - m T1 (previously DIN 7168 - m)

Attachment elements:

Swivel heads, rod clevis and rod end straight eyes as well as pivot brackets and pillow blocks for pivot pin attachments can be found in our main catalogue under Accessories.

Position sensing:

Three ways for position sensing are available:

- Pressure resistant inductive proximity switches for end-of-stroke polling.
- Magnetic field sensors for additional sensing of intermediate positions. (The cylinder length increases. If required please contact us.)
- Position measuring systems with various output signals for position measuring.

Technical specifications about end position sensing and position encoders can be found in our respective standard catalogue pages.

Attachment methods

Standard Cylinder Series SZ160



		Order No.	Description
		110	BASIC ATTACHMENT Clamping possible on cylinder tube
		110-1	BASIC ATTACHMENT With metric fine thread and grooved nut on cylinder tube (limited to strokes of up to 100 mm)
		111	THREAD ATTACHMENT With male thread on cylinder head
		111-1	THREAD ATTACHMENT Centering shoulder and threaded holes on the face of the cylinder head
		111-2	THREAD ATTACHMENT Centering shoulder and threaded holes on the face of the cylinder bottom
		112	FLANGE ATTACHMENT On front of cylinder head with 4 bolt holes
		112-1	FLANGE ATTACHMENT On back of cylinder head with 4 bolt holes
		113	FOOT ATTACHMENT Tangential foot screwed onto cylinder tube

Design subject to change

Revision B * 15.11.1996 *K.E.

Attachment methods

Standard Cylinder Series SZ160



Order No. Description

	<p>113-1</p>	<p>FOOT ATTACHMENT Angled foot screwed onto cylinder head</p>
	<p>113-2</p>	<p>FOOT ATTACHMENT Angled foot screwed onto cylinder head and angled foot shiftable along cylinder tube</p>
	<p>114</p>	<p>PIVOT PIN ATTACHMENT At front end of cylinder head</p>
	<p>114-1</p>	<p>PIVOT PIN ATTACHMENT At back end of cylinder head</p>
	<p>115</p>	<p>PIVOT PIN ATTACHMENT On cylinder tube, position adjustable</p>
	<p>116</p>	<p>PIVOT PIN ATTACHMENT At cylinder bottom (pivot pins removable)</p>
	<p>117</p>	<p>FLANGE ATTACHMENT At cylinder bottom with 4 bolt holes</p>
<p>View A:</p>	<p>118</p>	<p>PIVOT EYE ATTACHMENT With bronze bushing at cylinder bottom</p>

Design subject to change

Revision B * 15.11.1996 *K.E.

Attachment methods

Standard Cylinder Series SZ160



Order No. Description

<p>View A:</p>	<p>218</p>	<p>PIVOT EYE ATTACHMENT With bronze bushings both ends</p>
<p>View A:</p>	<p>119</p>	<p>PIVOT EYE ATTACHMENT With ball and socket joint at cylinder bottom</p>
<p>View A:</p>	<p>219</p>	<p>PIVOT EYE ATTACHMENT With ball and socket joints both ends</p>
	<p>120</p>	<p>NONDIFFERENTIAL CYLINDER Piston rod both sides, with thread attachment 111*)</p>
	<p>120-1</p>	<p>NONDIFFERENTIAL CYLINDER With stroke adjustment Piston rod both sides, with thread attachment 111*)</p>
<p>View A:</p>	<p>125</p>	<p>CLEVIS ATTACHMENT Clevis bracket at cylinder bottom</p>
<p>View A:</p>	<p>225</p>	<p>CLEVIS ATTACHMENT Both ends (clevis bracket at cylinder bottom and rod clevis at rod end)</p>

Design subject to change

Revision B * 15.11.1996 *K.E.

*) ... can be combine with other attachment modes

- Other attachment combinations available upon request -

Functional modes

Standard Cylinder Series SZ160

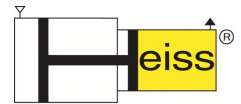

Symbol per DIN 24300	Identifier	Description
	001	Single acting, works pushing, return run requires outside force
	002	Single acting, works pulling, return run requires outside force
	003	Double acting
	004	Double acting, adjustable end-of-stroke damper on both sides
	005	Double acting, adjustable end-of-stroke damper on rod side
	006	Double acting, adjustable end-of-stroke damper on bottom side
	120.003	Double acting nondifferential cylinder
	120.004	Double acting nondifferential cylinder, adjustable end-of-stroke damper on both sides
	120.005	Double acting nondifferent cylinder, adjustable end-of-stroke damper on one side
Special functional modes		
	001-F	Single acting, works pushing, return run actuated by spring
	002-F	Single acting, works pulling, return run actuated by spring
	001	Plunger cylinder single acting, works pushing.
	003-T	Double acting tandem cylinder (high piston forces at small outside-Ø)

Standard Cylinder Series SZ 160



Configuration 110

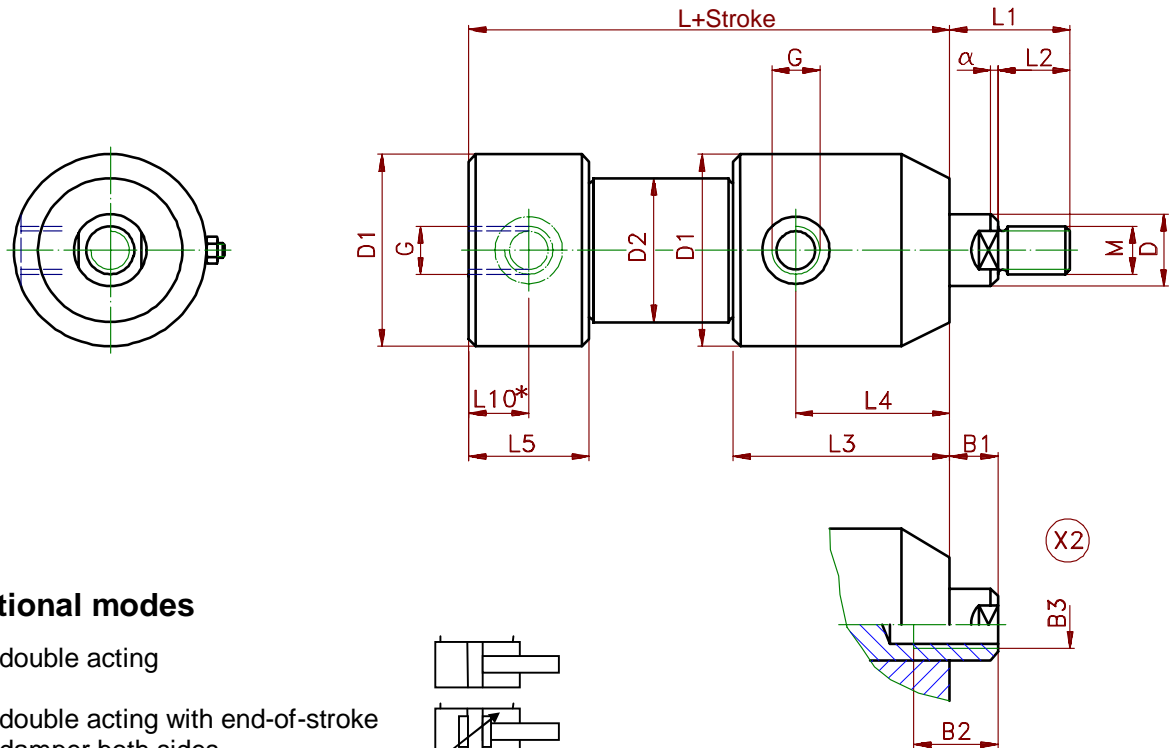

Functional modes

003 = double acting

004 = double acting with end-of-stroke damper both sides

005 = double acting with end-of stroke damper on rod side

006 = double acting with end-of-stroke damper on bottom side

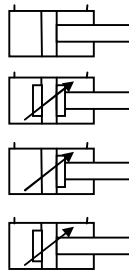

Piston rod end with female thread
Indicate required size when ordering
Or according to customers drawing

L10* only if radial port at bottom requested (indicate with cylinder order) !

Piston-ø	12	16	20	25	32	40	50	63	80	100	125	160	200
D rod ø	6	8	10	12	16	20	25	32	40	50	60	80	100
M	M5	M6	M8	M10	M14	M16	M20x1,5	M24x2	M35x1,5	M45x1,5	M58x1,5	M65x1,5	M80x2
D1	29	30	32	39	48	58	72	90	110	135	170	220	270
D2	18	22	25	30	38	48	60	75	92	115	145	190	245
L 003	64	64	70	82	87	100	111	126	138	171	212	300	340
L 004	84	84	100	122	127	140	161	166	178	221	292	400	460
L 005/006	74	74	85	102	107	120	136	146	158	196	252	350	400
L1	15	17	23	27	31	40	50	60	60	68	88	95	110
L2	10	12	14	16	20	25	30	40	35	45	58	65	80
L3	42	42	51	52	54	62	70	82	96	127	155	220	240
L4	23	23	25	26	28	35	40	48	55	75	95	145	145
L5	26	26	34	39	38	43	45	50	59	67	85	100	120
L10*	8	8	8	11	11	12	13	14	16	18	20	25	25
G	G1/8"	G1/8"	G1/8"	G1/8"	G1/4"	G1/4"	G3/8"	G3/8"	G1/2"	G1/2"	G3/4"	G1"	G1"
α	0,5x45°	0,5x45°	0,5x45°	1,5x30°	2x30°	2x30°	2,5x30°	3x30°	3x30°	3x30°	4x30°	5x30°	6x30°

Design subject to change

Revision B * 15.11.1996 *K.E.

Standard Cylinder Series SZ 160

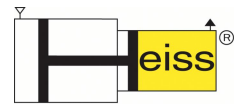

Configuration 110-1

- for stroke ranges up to 100 mm -

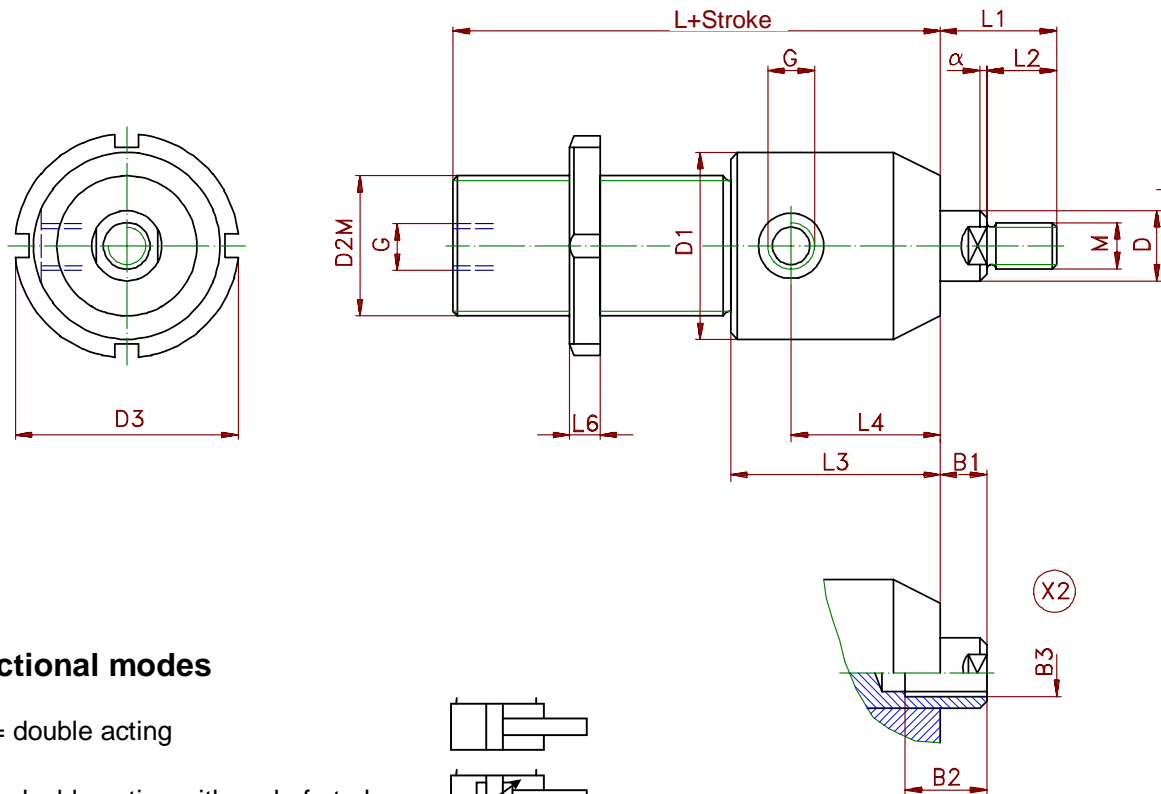

Functional modes

003 = double acting

004 = double acting with end-of-stroke damper on both sides

005 = double acting with end-of-stroke damper on rod side

006 = double acting with end-of-stroke damper on bottom side

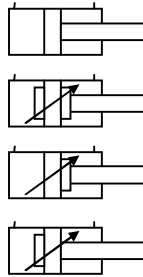

Piston rod end with female thread
Indicate required size when ordering
Or according to customers drawing

Piston-ø	12	16	20	25	32	40	50	63	80	100	125	160	200
D rod ø	6	8	10	12	16	20	25	32	40	50	60	80	100
M	M5	M6	M8	M10	M14	M16	M20x1,5	M24x2	M35x1,5	M45x1,5	M58x1,5	M65x1,5	M80x2
D1	29	30	32	39	48	58	72	90	110	135	170	220	270
D2M	M18x1,5	M22x1,5	M26x1,5	M30x1,5	M40x1,5	M50x1,5	M60x1,5	M75x1,5	M95x2	M120x2	M160x3	M205x3	M260x4
D3	34	40	45	50	52	75	90	110	135	165	210	250	330
L 003	63	63	68	77	82	93	104	119	132	168	192	280	315
L 004	83	83	100	117	122	133	154	159	172	218	272	380	435
L 005/006	73	73	85	97	102	113	129	139	152	193	232	330	375
L1	15	17	23	27	31	40	50	60	60	68	88	95	110
L2	10	12	14	16	20	25	30	40	35	45	58	65	80
L3	42	42	51	52	54	62	70	82	96	127	155	220	240
L4	23	23	25	26	28	35	40	48	55	75	95	145	145
L6	8	9	10	10	12	13	13	14	16	18	25	30	35
G	G1/8"	G1/8"	G1/8"	G1/8"	G1/4"	G1/4"	G3/8"	G3/8"	G1/2"	G1/2"	G3/4"	G1"	G1"
α	0,5x45°	0,5x45°	0,5x45°	1,5x30°	2x30°	2x30°	2,5x30°	3x30°	3x30°	3x30°	4x30°	5x30°	6x30°

Design subject to change

Revision B * 15.11.1996 *K.E.

Standard Cylinder Series SZ 160

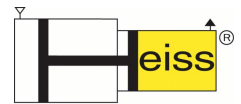

Configuration 111

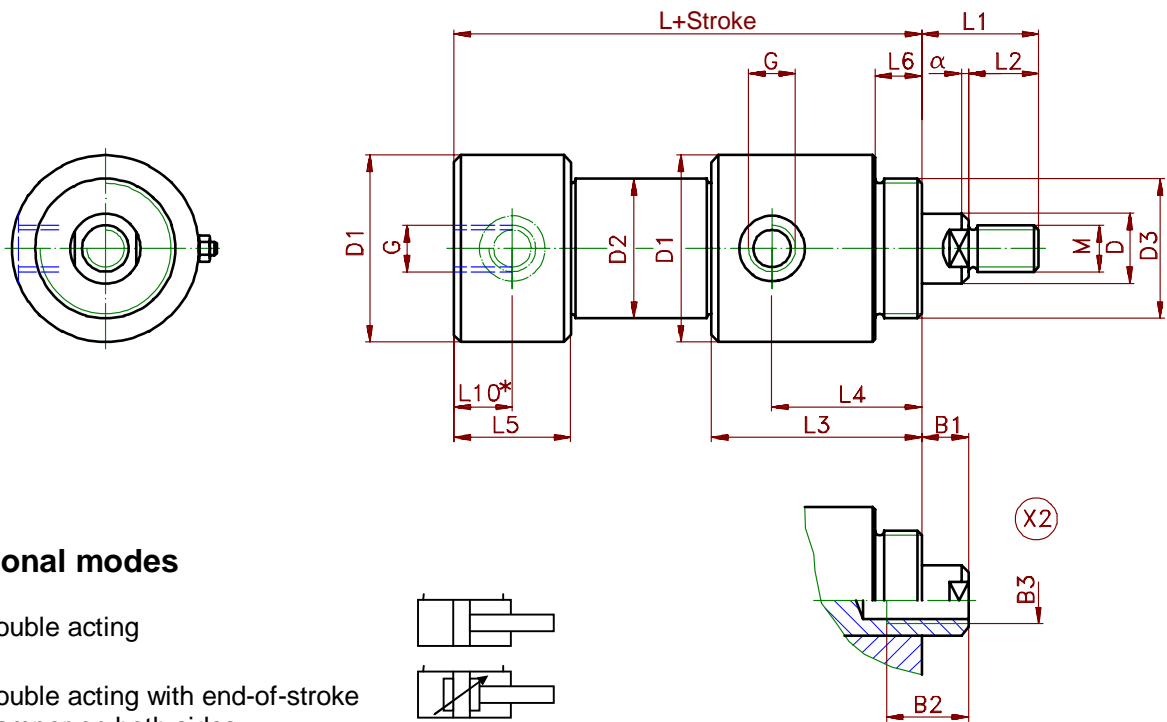

Functional modes

003 = double acting

004 = double acting with end-of-stroke damper on both sides

005 = double acting with end-of-stroke damper on rod side

006 = double acting with end-of-stroke damper on bottom side

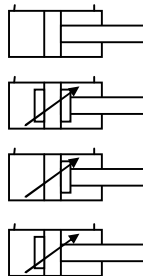

Piston rod end with female thread
Indicate required size when ordering
Or according to customers drawing

L10* only if radial port at bottom requested (indicate with cylinder order) !

Kolben-ø	12	16	20	25	32	40	50	63	80	100	125	160	200
D rod ø	6	8	10	12	16	20	25	32	40	50	60	80	100
M	M5	M6	M8	M10	M14	M16	M20x1,5	M24x2	M35x1,5	M45x1,5	M58x1,5	M65x1,5	M80x2
D1	29	30	32	39	48	58	72	90	110	135	170	220	270
D2	18	22	25	30	38	48	60	75	92	115	145	190	245
D3	M16x1,5	M20x1,5	G 1/2"	G 3/4"	G 1"	G 1 1/4"	G 1 1/2"	G 2"	G 2 1/2"	G 3"	M125x3	M180x3	M200x3
L 003	64	64	70	82	87	100	111	126	138	171	212	300	340
L 004	84	84	100	122	127	140	161	166	178	221	292	400	460
L 005/006	74	74	85	102	107	120	136	146	158	196	252	350	400
L1	15	17	23	27	31	40	50	60	60	70	88	95	110
L2	10	12	14	16	20	25	30	40	35	45	58	65	80
L3	42	42	51	52	54	62	70	82	96	127	155	220	240
L4	23	23	25	26	28	35	40	48	55	75	95	145	145
L5	26	26	34	39	38	43	45	50	59	67	85	100	120
L6	8	8	9	9	11	14	16	20	25	35	40	48	68
L10*	8	8	8	11	11	12	13	14	16	18	20	25	25
G	G 1/8"	G 1/8"	G 1/8"	G 1/8"	G 1/4"	G 1/4"	G 3/8"	G 3/8"	G 1/2"	G 1/2"	G 3/4"	G 1"	G 1"
α	0,5x45°	0,5x45°	0,5x45°	1,5x30°	2x30°	2x30°	2,5x30°	3x30°	3x30°	3x30°	4x30°	5x30°	6x30°

Design subject to change

Revision B * 15.11.1996 *K.E.

Standard Cylinder Series SZ 160



Configuration 111-1

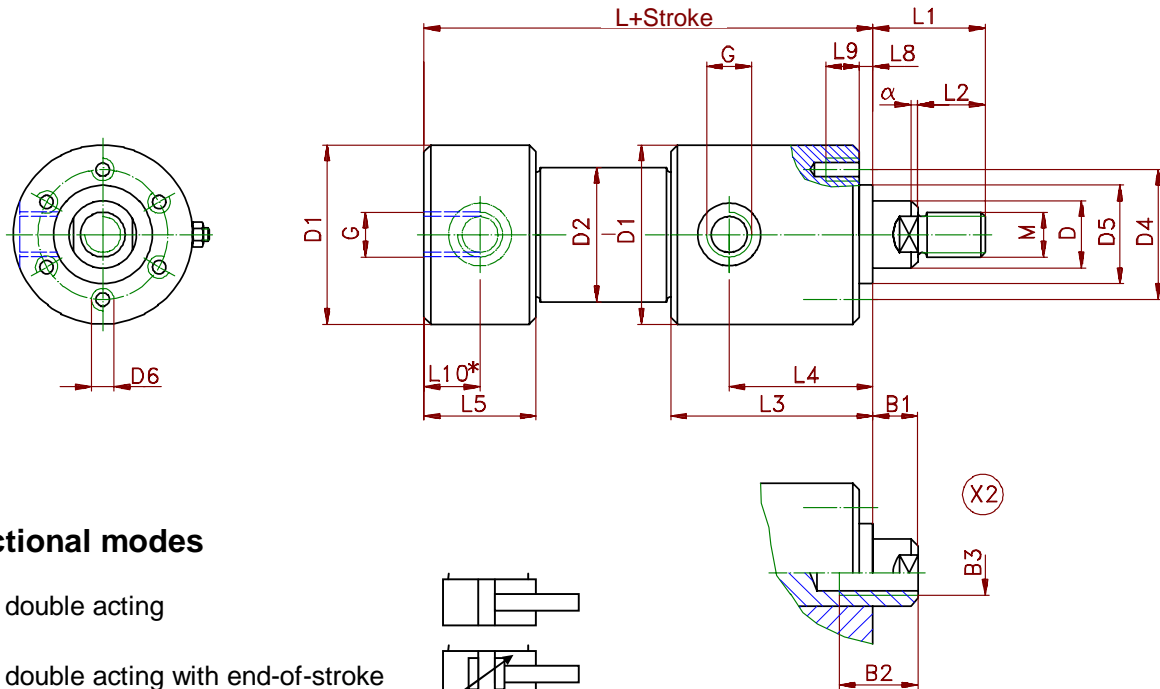

Functional modes

003 = double acting

004 = double acting with end-of-stroke damper on both sides

005 = double acting with end-of-stroke damper on rod side

006 = double acting with end-of-stroke damper on bottom side

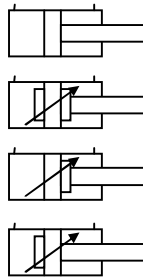

Piston rod end with female thread
Indicate required size when ordering
Or according to customers drawing

L10* only if radial port at bottom requested (indicate with cylinder order) !

Piston-ø	12	16	20	25	32	40	50	63	80	100	125	160	200
D rod ø	6	8	10	12	16	20	25	32	40	50	60	80	100
M	M5	M6	M8	M10	M14	M16	M20x1,5	M24x2	M35x1,5	M45x1,5	M58x1,5	M65x1,5	M80x2
D1	29	30	32	39	48	58	72	90	110	135	170	220	270
D2	18	22	25	30	38	48	60	75	92	115	145	190	245
D4	22	23	26	30	38	45	58	65	84	102	140	180	220
D5 f7	15	15	18	22	28	33	42	48	60	72	100	140	160
D6	4xM4	4xM4	M4	M5	M5	M6	M6	M8	M10	M12	M16	M20	M24
L 003	64	64	70	82	87	100	111	126	138	171	212	300	340
L 004	84	84	100	122	127	140	161	166	178	221	292	400	460
L 005/006	74	74	85	102	107	120	136	146	158	196	252	350	400
L1	15	17	23	27	31	40	50	60	60	70	88	95	110
L2	10	12	14	16	20	25	30	40	35	45	58	65	80
L3	42	42	51	52	54	62	70	82	96	127	155	220	240
L4	23	23	25	26	28	35	40	48	55	75	95	145	145
L5	26	26	34	39	38	43	45	50	59	67	85	100	120
L8	2	2	2	2	3	3	3	3	3	3	5	5	5
L9	8	8	8	10	10	12	12	16	20	24	32	40	48
L10*	8	8	8	11	11	12	13	14	16	18	20	25	25
G	G1/8"	G1/8"	G1/8"	G1/8"	G1/4"	G1/4"	G3/8"	G3/8"	G1/2"	G1/2"	G3/4"	G1"	G1"
α	0,5x45°	0,5x45°	0,5x45°	1,5x30°	2x30°	2x30°	2,5x30°	3x30°	3x30°	3x30°	4x30°	5x30°	6x30°

Design subject to change

Revision B * 15.11.1996 *K.E.

Standard Cylinder Series SZ 160



Configuration 111-2

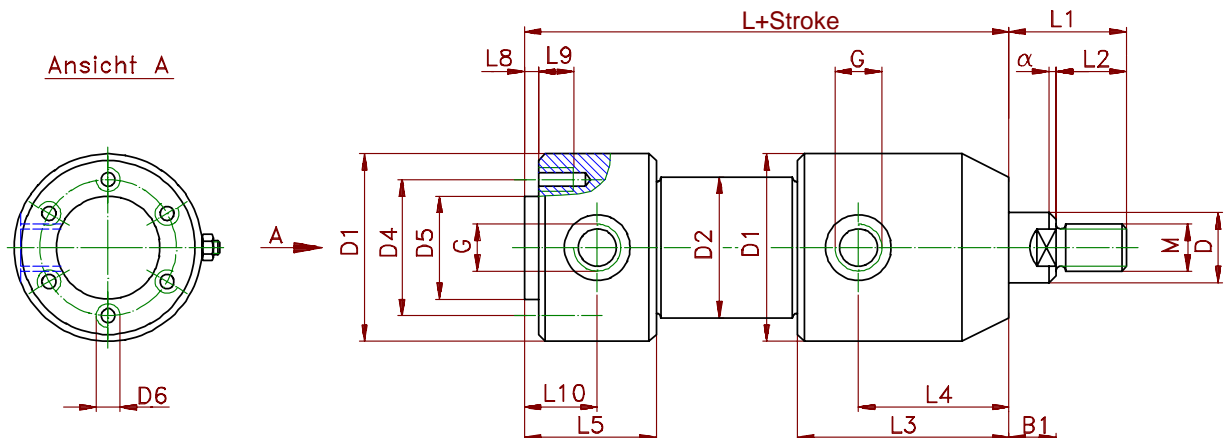

Functional modes

003 = double acting

004 = double acting with end-of-stroke damper on both sides

005 = double acting with end-of-stroke damper on rod side

006 = double acting with end-of-stroke damper on bottom side

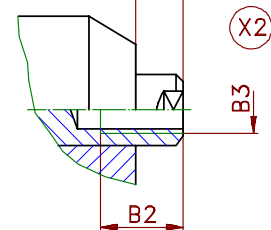
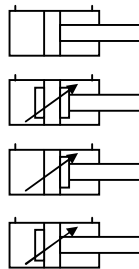

Piston rod end with female thread
Indicate required size when ordering
Or according to customers drawing.

Kolben-ø	12	16	20	25	32	40	50	63	80	100	125	160	200
D rod ø	6	8	10	12	16	20	25	32	40	50	60	80	100
M	M5	M6	M8	M10	M14	M16	M20x1,5	M24x2	M35x1,5	M45x1,5	M58x1,5	M65x1,5	M80x2
D1	29	30	32	39	48	58	72	90	110	135	170	220	270
D2	18	22	25	30	38	48	60	75	92	115	145	190	245
D4	22	23	26	30	38	45	58	65	84	102	140	180	220
D5 f7	15	15	18	22	28	33	42	48	60	72	100	140	160
D6	4xM4	4xM4	M4	M5	M5	M6	M6	M8	M10	M12	M16	M20	M24
L 003	70	72	80	93	99	100	111	126	138	171	214	300	340
L 004	90	92	110	133	139	140	161	166	178	221	294	400	460
L 005/006	80	82	95	113	119	120	136	146	158	196	254	350	400
L1	15	17	23	27	31	40	50	60	60	68	88	95	110
L2	10	12	14	16	20	25	30	40	35	45	58	65	80
L3	42	42	51	52	54	62	70	82	96	127	155	220	240
L4	23	23	25	26	28	35	40	48	55	75	95	145	145
L5	32	34	44	50	50	43	45	50	59	67	85	100	120
L8	2	2	2	2	3	3	3	3	3	3	5	5	5
L9	6	6	6	8	8	10	10	12	15	20	24	30	38
L10	14	16	18	22	24	15	15	16	17	20	24	29	33
G	G1/8"	G1/8"	G1/8"	G1/8"	G1/4"	G1/4"	G3/8"	G3/8"	G1/2"	G1/2"	G3/4"	G1"	G1"
α	0,5x45°	0,5x45°	0,5x45°	1,5x30°	2x30°	2x30°	2,5x30°	3x30°	3x30°	3x30°	4x30°	5x30°	6x30°

Design subject to change

Revision B * 15.11.1996 *K.E.

()

()

Standard Cylinder Series SZ 160



Configuration 112

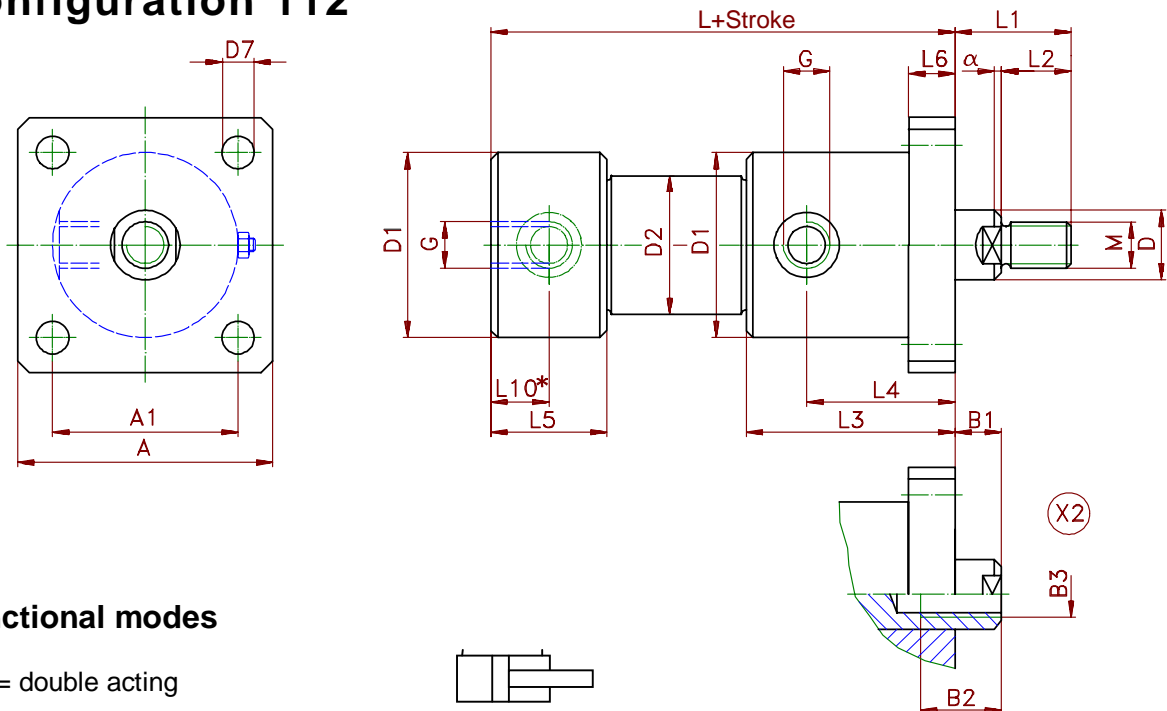

Functional modes

003 = double acting

004 = double acting with end-of-stroke damper on both sides

005 = double acting with end-of-stroke damper on rod side

006 = double acting with end-of-stroke damper on bottom side

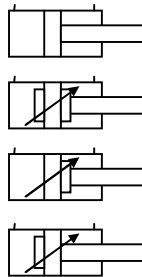

Piston rod end with female thread
Indicate required size when ordering
Or according to customers drawing

L10* only if radial port at bottom requested (indicate with cylinder order) !

Kolben-ø	12	16	20	25	32	40	50	63	80	100	125	160	200
D rod ø	6	8	10	12	16	20	25	32	40	50	60	80	100
M	M5	M6	M8	M10	M14	M16	M20x1,5	M24x2	M35x1,5	M45x1,5	M58x1,5	M65x1,5	M80x2
D1	29	30	32	39	48	58	72	90	110	135	170	220	270
D2	18	22	25	30	38	48	60	75	92	115	145	190	245
D7	6	6	7	7	9	11	13,5	13,5	17,5	17,5	30	39	45
L 003	64	64	70	82	87	100	111	126	138	171	212	300	340
L 004	84	84	100	122	127	140	161	166	178	221	292	400	460
L 005/006	74	74	85	102	107	120	136	146	158	196	252	350	400
L1	15	17	23	27	31	40	50	60	60	70	88	95	110
L2	10	12	14	16	20	25	30	40	35	45	58	65	80
L3	42	42	51	52	54	62	70	82	96	127	155	220	240
L4	23	23	25	26	28	35	40	48	55	75	95	145	145
L5	26	26	34	39	38	43	45	50	59	67	85	100	120
L6	8	8	9	9	11	14	16	20	25	35	40	48	68
L10*	8	8	8	11	11	12	13	14	16	18	20	25	25
A1	28	28	36	36	48	62	70	80	96	115	160	200	250
A	40	40	50	50	65	90	100	110	130	150	220	270	350
G	G1/8"	G1/8"	G1/8"	G1/8"	G1/4"	G1/4"	G3/8"	G3/8"	G1/2"	G1/2"	G3/4"	G1"	G1"
α	0,5x45°	0,5x45°	0,5x45°	1,5x30°	2x30°	2x30°	2,5x30°	3x30°	3x30°	3x30°	4x30°	5x30°	6x30°

Design subject to change

Revision B * 15.11.1996 *K.E.

Standard Cylinder Series SZ 160



Configuration 112-1

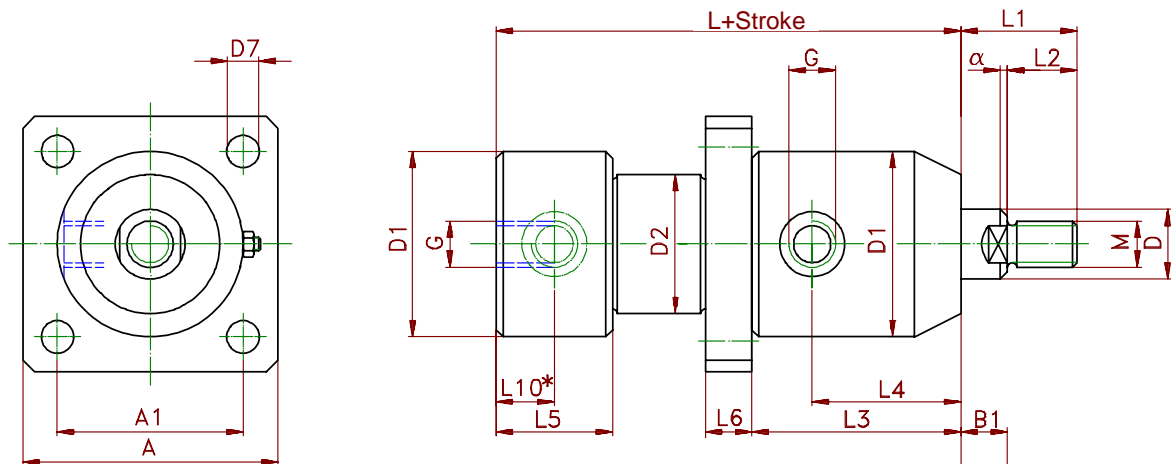

Functional modes

003 = double acting

004 = double acting with end-of-stroke damper on both sides

005 = double acting with end-of-stroke damper on rod side

006 = double acting with end-of-stroke damper on bottom side

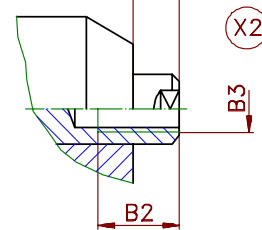
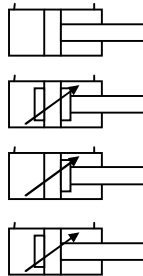

Piston rod end with female thread
Indicate required size when ordering
Or according to customers drawing

L10* only if radial port at bottom requested (indicate with cylinder order) !

Piston-ø	12	16	20	25	32	40	50	63	80	100	125	160	200
D rod ø	6	8	10	12	16	20	25	32	40	50	60	80	100
M	M5	M6	M8	M10	M14	M16	M20x1,5	M24x2	M35x1,5	M45x1,5	M58x1,5	M65x1,5	M80x2
D1	29	30	32	39	48	58	72	90	110	135	170	220	270
D2	18	22	25	30	38	48	60	75	92	115	145	190	245
D7	6	6	7	7	9	11	13,5	13,5	17,5	17,5	30	39	45
L 003	64	64	70	82	87	100	111	126	138	171	212	300	340
L 004	84	84	100	122	127	140	161	166	178	221	292	400	460
L 005/006	74	74	85	102	107	120	136	146	158	196	252	350	400
L1	15	17	23	27	31	40	50	60	60	68	88	95	110
L2	10	12	14	16	20	25	30	40	35	45	58	65	80
L3	42	42	51	52	54	62	70	82	96	127	155	220	240
L4	23	23	25	26	28	35	40	48	55	75	95	145	145
L5	26	26	34	39	38	43	45	50	59	67	85	100	120
L6	8	8	9	9	11	14	16	20	25	35	40	48	68
L10*	8	8	8	11	11	12	13	14	16	18	20	25	25
A1	28	28	36	36	48	62	70	80	96	115	160	200	250
A	40	40	50	50	65	90	100	110	130	150	220	270	350
G	G1/8"	G1/8"	G1/8"	G1/8"	G1/4"	G1/4"	G3/8"	G3/8"	G1/2"	G1/2"	G3/4"	G1"	G1"
α	0,5x45°	0,5x45°	0,5x45°	1,5x30°	2x30°	2x30°	2,5x30°	3x30°	3x30°	3x30°	4x30°	5x30°	6x30°

Design subject to change

Revision B * 15.11.1996 *K.E.*\..SZ 160 EN

Standard Cylinder Series SZ 160

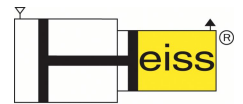

Configuration 113

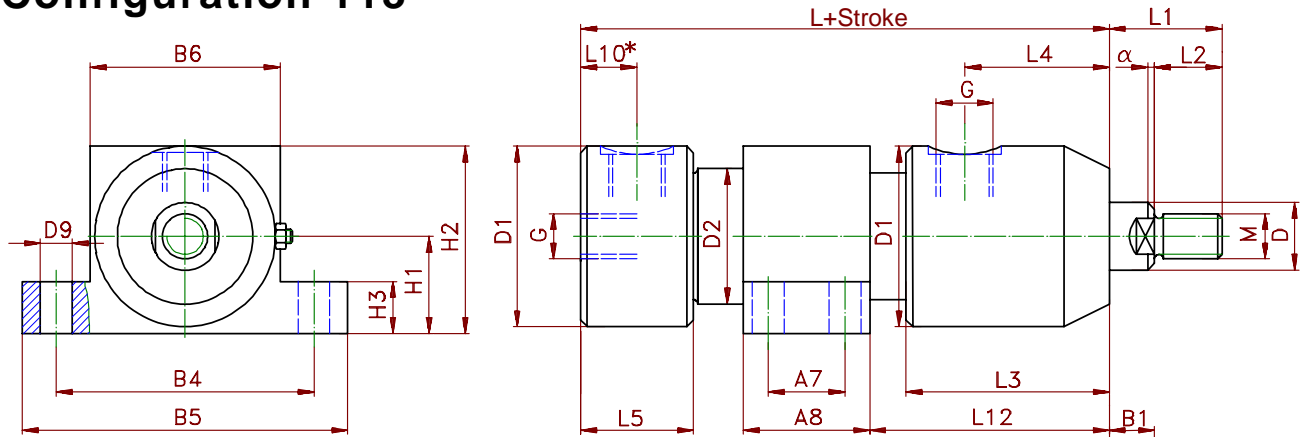

Functional modes

003 = double acting

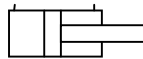

004 = double acting with end-of-stroke damper on both sides

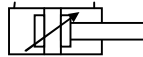

005 = double acting with end-of-stroke damper on rod side

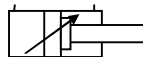

006 = double acting with end-of-stroke damper on bottom side

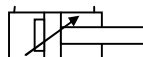

Piston rod end with female thread
Indicate required size when ordering
Or according to customers drawing

L10* only if radial port at bottom requested (indicate with cylinder order) !

Piston -ø	12	16	20	25	32	40	50	63	80	100	125	160	200			
D rod ø	6	8	10	12	16	20	25	32	40	50	60	80	100			
M	M5	M6	M8	M10	M14	M16	M20x1,5	M24x2	M35x1,5	M45x1,5	M58x1,5	M65x1,5	M80x2			
D1	29	30	32	39	48	58	72	90	110	135	170	220	2700			
D2	18	22	25	30	38	48	60	75	92	115	145	190	2455			
D9	6	7	9	11	13,5	17,5	17,5	21,5	21,5	26						
L 003	64	64	70	82	87	100	111	126	138	171	212	300	340			
L 004	84	84	100	122	127	140	161	166	178	221	292	400	460			
L 005/006	74	74	85	102	107	120	136	146	158	196	252	350	400			
L1	15	17	23	27	31	40	50	60	60	70	88	95	110			
L2	10	12	14	16	20	25	30	40	35	45	58	65	80			
L3	42	42	51	52	54	62	70	82	96	127	155	220	240			
L4	23	23	25	26	28	35	40	48	55	75	95	145	145			
L5	26	26	34	39	38	43	45	50	59	67	85	100	120			
L10*	8	8	8	11	11	12	13	14	16	18						
L12	- variable - indicate desired size when ordering															
A7	20	22	24	28	30	38	46	60	80	100	For piston sizes 125, 160 and 200 please request catalogue sheet K - 100 - 083					
A8	30	35	40	50	55	70	80	100	120	150						
B4	42	45	55	70	80	100	110	135	155	190						
B5	55	60	75	90	110	130	140	175	195	240						
B6	30	32	37	45	50	64	75	95	115	140						
H1	15	18	21	26	28	36	41	50	60	75						
H2	30	35	40	50	55	70	80	100	120	150						
H3	10	10	15	18	20	25	30	40	45	50						
G	G1/8"	G1/8"	G1/8"	G1/8"	G1/4"	G1/4"	G3/8"	G3/8"	G1/2"	G1/2"				G3/4"	G1"	G1"
α	0,5x45°	0,5x45°	0,5x45°	1,5x30°	2x30°	2x30°	2,5x30°	3x30°	3x30°	3x30°				4x30°	5x30°	6x30°

Design subject to change

Revision B * 15.11.1996 *K.E.

Standard Cylinder Series SZ 160

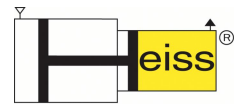

Configuration 113-1

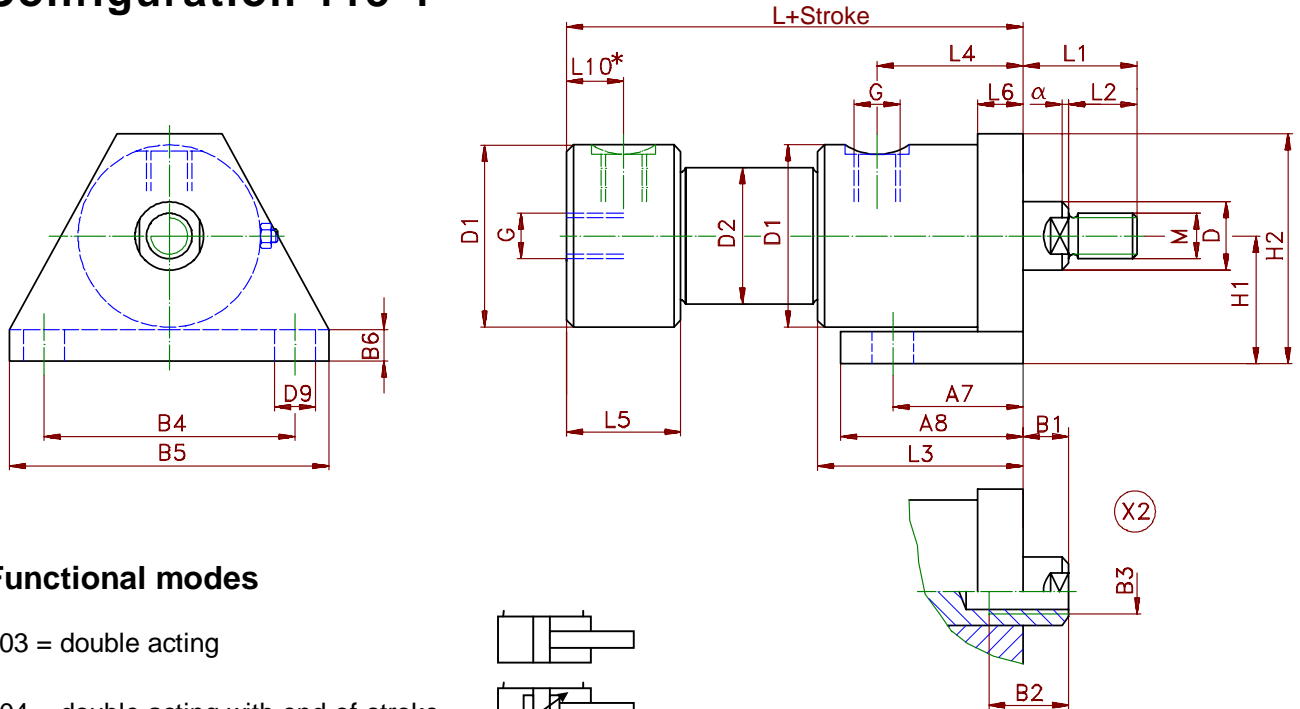

Functional modes

003 = double acting

004 = double acting with end-of-stroke damper on both sides

005 = double acting with end-of-stroke damper on rod side

006 = double acting with end-of-stroke damper on bottom side

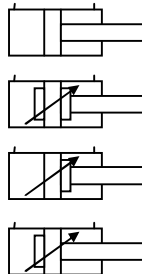

Piston rod end with female thread
Indicate desired size when ordering
Or according to customers drawing

L10* only if radial port at bottom requested (indicate with cylinder order) !

Piston -ø	12	16	20	25	32	40	50	63	80	100	125	160	200
D rod ø	6	8	10	12	16	20	25	32	40	50	60	80	100
M	M5	M6	M8	M10	M14	M16	M20x1,5	M24x2	M35x1,5	M45x1,5	M58x1,5	M65x1,5	M80x2
D1	29	30	32	39	48	58	72	90	110	135	170	220	270
D2	18	22	25	30	38	48	60	75	92	115	145	190	245
D9	6	6	7	9	11	13,5	17,5	17,5	21,5	26			
L 003	64	64	70	82	87	100	111	126	138	171	212	300	340
L 004	84	84	100	122	127	140	161	166	178	221	292	400	460
L 005/006	74	74	85	102	107	120	136	146	158	196	252	350	400
L1	15	17	23	27	31	40	50	60	60	70	88	95	110
L2	10	12	14	16	20	25	30	40	35	45	58	65	80
L3	42	42	51	52	54	62	70	82	96	127	155	220	240
L4	23	23	25	26	28	35	40	48	55	75	95	145	145
L5	26	26	34	39	38	43	45	50	59	67	85	100	120
L6	8	8	9	9	11	14	16	20	25	35			
L10*	8	8	8	11	11	12	13	14	16	18			
A7	18	18	20	22	24	30	35	45	50	70			
A8	35	35	40	45	55	50	65	80	90	140			
B4	40	40	40	45	60	80	90	110	130	200			
B5	55	55	55	62	80	110	130	140	170	260			
B6	5	5	6	8	10	12	15	20	25	40			
H1	20	20	22	25	32	40	50	65	80	115			
H2	35	35	40	45	55	70	90	110	135	190			
G	G1/8"	G1/8"	G1/8"	G1/8"	G1/4"	G1/4"	G3/8"	G3/8"	G1/2"	G1/2"	G3/4"	G1"	G1"
α	0,5x45°	0,5x45°	0,5x45°	1,5x30°	2x30°	2x30°	2,5x30°	3x30°	3x30°	3x30°	4x30°	5x30°	6x30°

For piston sizes 125, 160 and 200 please request catalogue sheet K - 100 - 083

Standard Cylinder Series SZ 160

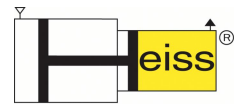

Configuration 113-2

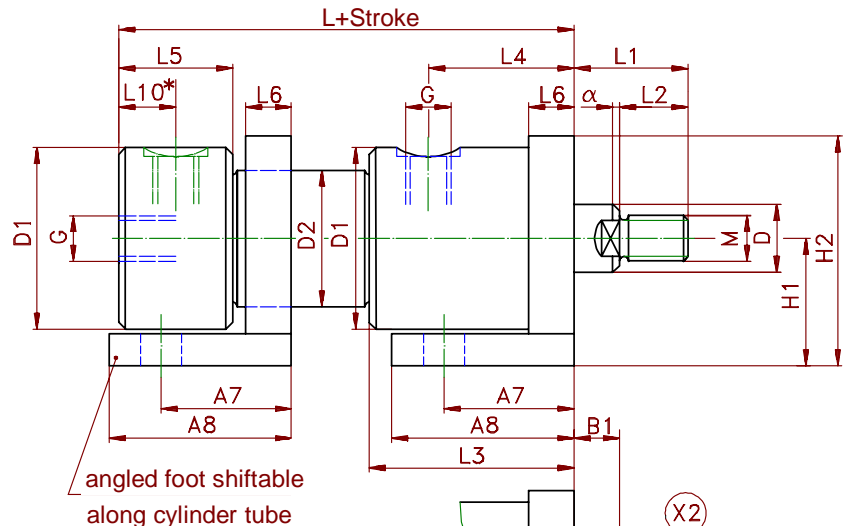
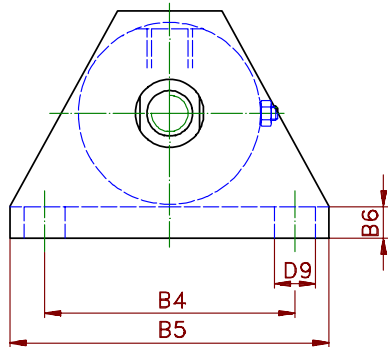

angled foot shiftable along cylinder tube

Functional modes

- 003 = double acting
- 004 = double acting with end-of-stroke damper on both sides
- 005 = double acting with end-of-stroke damper on rod side
- 006 = double acting with end-of-stroke damper on rod side

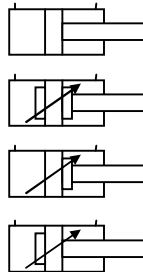

Piston rod end with female thread
Indicate desired size when ordering
Or according to customers drawing

L10* only if radial port at bottom requested (indicate with cylinder order)

Piston -ø	12	16	20	25	32	40	50	63	80	100	125	160	200
D rod ø	6	8	10	12	16	20	25	32	40	50	60	80	100
M	M5	M6	M8	M10	M14	M16	M20x1,5	M24x2	M35x1,5	M45x1,5	M58x1,5	M65x1,5	M80x2
D1	29	30	32	39	48	58	72	90	110	135	170	220	270
D2	18	22	25	30	38	48	60	75	92	115	145	190	245
D9	6	6	7	9	11	13,5	17,5	17,5	21,5	26			
L 003	64	64	70	82	87	100	111	126	138	171	212	300	340
L 004	84	84	100	122	127	140	161	166	178	221	292	400	460
L 005/006	74	74	85	102	107	120	136	146	158	196	252	350	400
L1	15	17	23	27	31	40	50	60	60	70	88	95	110
L2	10	12	14	16	20	25	30	40	35	45	58	65	80
L3	42	42	51	52	54	62	70	82	96	127	155	220	240
L4	23	23	25	26	28	35	40	48	55	75	95	145	145
L5	26	26	34	39	38	43	45	50	59	67	85	100	120
L6	8	8	9	9	11	14	16	20	25	35			
L10*	8	8	8	11	11	12	13	14	16	18			
A7	18	18	20	22	24	30	35	45	50	70			
A8	35	35	40	45	55	50	65	80	90	140			
B4	40	40	40	45	60	80	90	110	130	200			
B5	55	55	55	62	80	110	130	140	170	260			
B6	5	5	6	8	10	12	15	20	25	40			
H1	20	20	22	25	32	40	50	65	80	115			
H2	35	35	40	45	55	70	90	110	135	190			
G	G1/8"	G1/8"	G1/8"	G1/8"	G1/4"	G1/4"	G3/8"	G3/8"	G1/2"	G1/2"	G3/4"	G1"	G1"
α	0,5x45°	0,5x45°	0,5x45°	1,5x30°	2x30°	2x30°	2,5x30°	3x30°	3x30°	3x30°	4x30°	5x30°	6x30°

For piston sizes 125, 160 und 200 please request catalogue sheet K - 100 - 083

Standard Cylinder Series SZ 160



Configuration 114

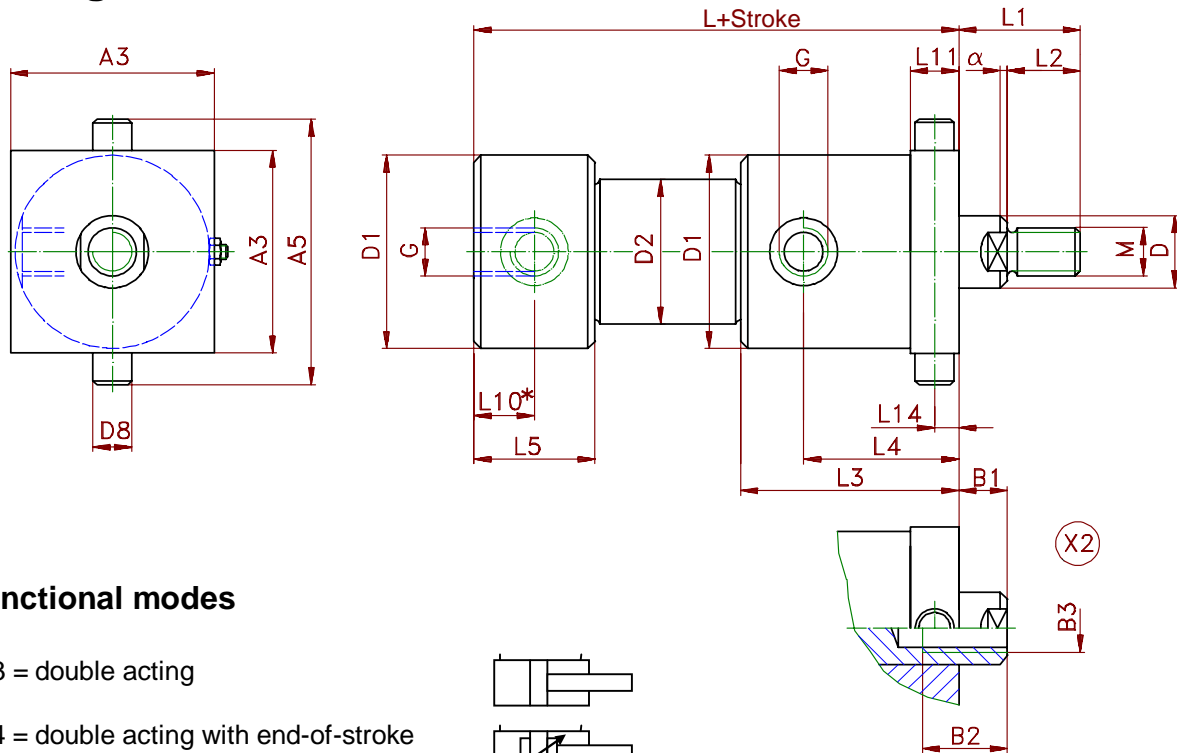

Functional modes

003 = double acting

004 = double acting with end-of-stroke damper on both sides

005 = double acting with end-of-stroke damper on rod side

006 = double acting with end-of-stroke damper on rod side

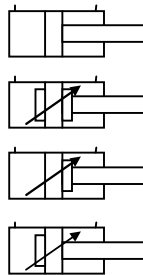

Piston rod end with female thread
Indicate desired size when ordering
Or according to customers drawing

L10* only if radial port at bottom requested (indicate with cylinder order)

Piston-ø	12	16	20	25	32	40	50	63	80	100	125	160	200
D rod ø	6	8	10	12	16	20	25	32	40	50	60	80	100
M	M5	M6	M8	M10	M14	M16	M20X1,5	M24X2	M35X1,5	M45X1,5	M58X1,5	M65X1,5	M80X2
D1	29	30	32	39	48	58	72	90	110	135	170	220	270
D2	18	22	25	30	38	48	60	75	92	115	145	190	245
D8 f7	5	6	8	10	14	16	20	25	40	50	60	70	80
L 003	64	64	70	82	87	100	111	126	138	171	212	300	340
L 004	84	84	100	122	127	140	161	166	178	221	292	400	460
L 005/006	74	74	85	102	107	120	136	146	158	196	252	350	400
L1	15	17	23	27	31	40	50	60	60	70	88	95	110
L2	10	12	14	16	20	25	30	40	40	35	45	58	80
L3	42	42	51	52	54	62	70	82	96	127	155	220	240
L4	23	23	25	26	28	35	40	48	55	75	95	145	145
L5	26	26	34	39	38	43	45	50	59	67	85	100	120
L10*	8	8	8	11	11	12	13	14	16	18	20	25	25
L11	10	10	12	14	18	22	28	28	42	54	64	74	100
L14	5	5	6	7	9	11	14	14	21	27	32	37	50
A3	30	30	35	40	50	60	75	92	112	145	175	225	275
A5	40	42	51	60	78	92	115	140	210	240	290	360	430
G	G1/8"	G1/8"	G1/8"	G1/8"	G1/4"	G1/4"	G3/8"	G3/8"	G1/2"	G1/2"	G3/4"	G1"	G1"
α	0,5x45°	0,5x45°	0,5x45°	1,5x30°	2x30°	2x30°	2,5x30°	3x30°	3x30°	3x30°	4x30°	5x30°	6x30°

Design subject to change

Revision B * 15.11.1996 *K.E.

Standard Cylinder Series SZ 160

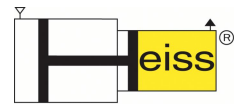

Configuration 114-1

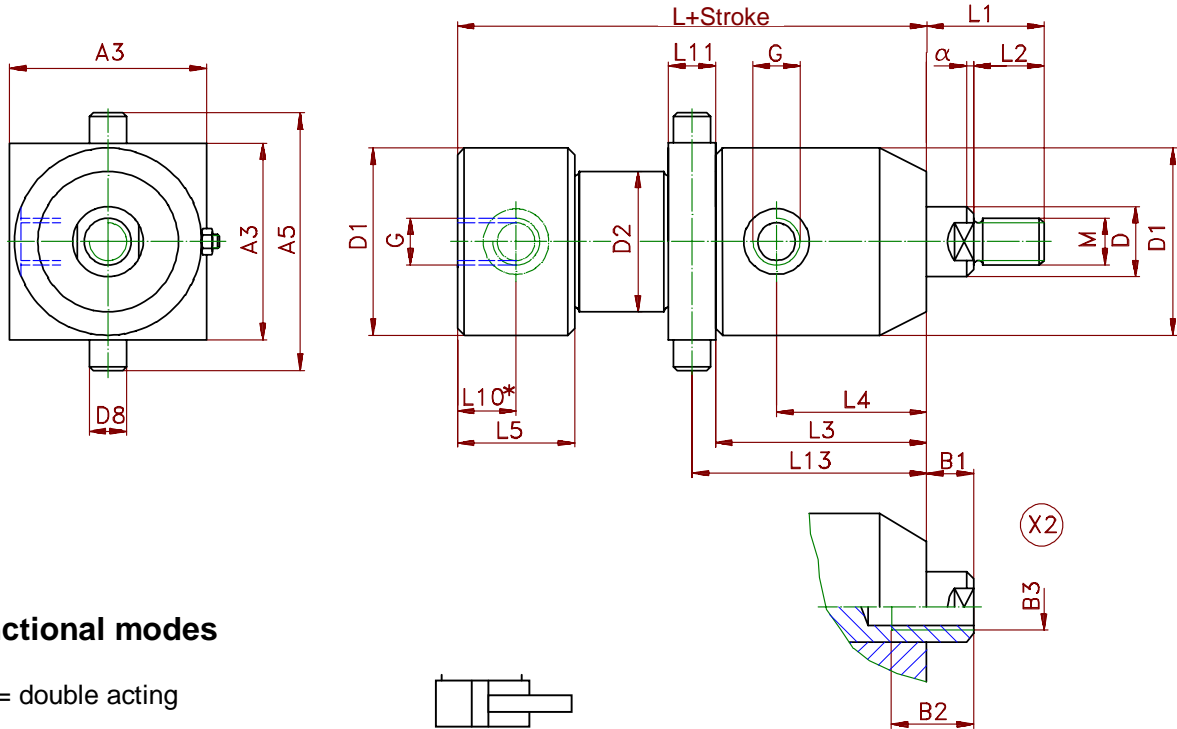

Functional modes

003 = double acting

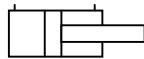

004 = double acting with end-of-stroke damper on both sides

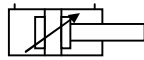

005 = double acting with end-of-stroke damper on rod side

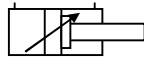

006 = double acting with end-of-stroke damper on bottom side

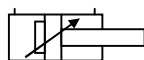

Piston rod end with female thread
Indicate required size when ordering
Or according to customers drawing

L10* only if radial port at bottom requested (indicate with cylinder order) !

Kolben-ø	12	16	20	25	32	40	50	63	80	100	125	160	200
D rod ø	6	8	10	12	16	20	25	32	40	50	60	80	100
M	M5	M6	M8	M10	M14	M16	M20X1,5	M24X2	M35X1,5	M45X1,5	M58X1,5	M65X1,5	M80X2
D1	29	30	32	39	48	58	72	90	110	135	170	220	270
D2	18	22	25	30	38	48	60	75	92	115	145	190	245
D8 f7	5	6	8	10	14	16	20	25	40	50	60	70	80
L 003	64	64	70	82	87	100	111	126	138	171	212	300	340
L 004	84	84	100	122	127	140	161	166	178	221	292	400	460
L 005/006	74	74	85	102	107	120	136	146	158	196	252	350	400
L1	15	17	23	27	31	40	50	60	60	68	88	95	110
L2	10	12	14	16	20	25	30	40	35	45	58	65	80
L3	42	42	51	52	54	62	70	82	96	127	155	220	240
L4	23	23	25	26	28	35	40	48	55	75	95	145	145
L5	26	26	34	39	38	43	45	50	59	67	85	100	120
L10*	8	8	8	11	11	12	13	14	16	18	20	25	25
L11	10	10	12	14	18	22	28	28	42	54	64	74	100
L13	47	47	57	59	63	73	84	96	117	154	187	257	290
A3	30	30	35	40	50	60	75	92	112	145	175	225	275
A5	40	42	51	60	78	92	115	140	210	240	290	360	430
G	G1/8"	G1/8"	G1/8"	G1/8"	G1/4"	G1/4"	G3/8"	G3/8"	G1/2"	G1/2"	G3/4"	G1"	G1"
α	0,5x45°	0,5x45°	0,5x45°	1,5x30°	2x30°	2x30°	2,5x30°	3x30°	3x30°	3x30°	4x30°	5x30°	6x30°

Design subject to change

Revision B1 * 06.05.1998 *K.E.

Standard Cylinder Series SZ 160

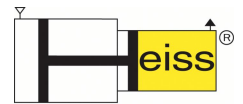

Configuration 115

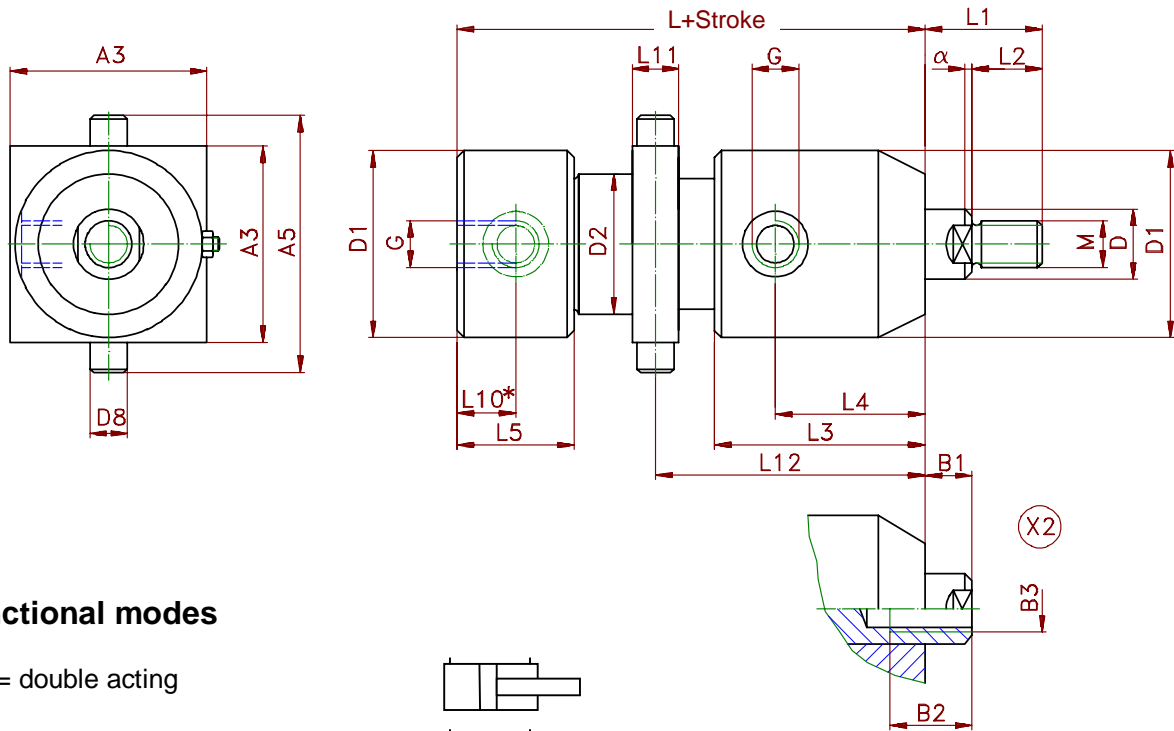

Functional modes

003 = double acting



004 = double acting with end-of-stroke damper on both sides

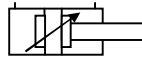

005 = double acting with end-of-stroke damper on rod side

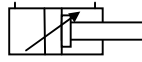

006 = double acting with end-of-stroke damper on bottom side

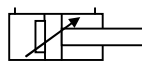

Piston rod end with female thread
Indicate desired size when ordering
Or according to customers drawing

L10* only if radial port at bottom requested (indicate with cylinder order) !

Kolben-ø	12	16	20	25	32	40	50	63	80	100	125	160	200
D rod ø	6	8	10	12	16	20	25	32	40	50	60	80	100
M	M5	M6	M8	M10	M14	M16	M20X1,5	M24X2	M35X1,5	M45X1,5	M58X1,5	M65X1,5	M80X2
D1	29	30	32	39	48	58	72	90	110	135	170	220	270
D2	18	22	25	30	38	48	60	75	92	115	145	190	245
D8 f7	5	6	8	10	14	16	20	25	40	50	60	70	80
L 003	64	64	70	82	87	100	111	126	138	171	212	300	340
L 004	84	84	100	122	127	140	161	166	178	221	292	400	460
L 005/006	74	74	85	102	107	120	136	146	158	196	252	350	400
L1	15	17	23	27	31	40	50	60	60	70	88	95	110
L2	10	12	14	16	20	25	30	40	35	45	58	65	80
L3	42	42	51	52	54	62	70	82	96	127	155	220	240
L4	23	23	25	26	28	35	40	48	55	75	95	145	145
L5	26	26	34	39	38	43	45	50	59	67	85	100	120
L10*	8	8	8	11	11	12	13	14	16	18	20	25	25
L11	10	10	12	14	18	22	28	28	42	54	64	74	100
L12	- variable – indicate desired size when ordering												
A3	30	30	35	40	50	60	75	92	112	145	175	225	275
A5	40	42	51	60	78	92	115	140	210	240	290	360	430
G	G1/8"	G1/8"	G1/8"	G1/8"	G1/4"	G1/4"	G3/8"	G3/8"	G1/2"	G1/2"	G3/4"	G1"	G1"
α	0,5x45°	0,5x45°	0,5x45°	1,5x30°	2x30°	2x30°	2,5x30°	3x30°	3x30°	3x30°	4x30°	5x30°	6x30°

Design subject to change

Revision B * 15.11.1996 *K.E.

()

()

Standard Cylinder Series SZ 160



Configuration 116

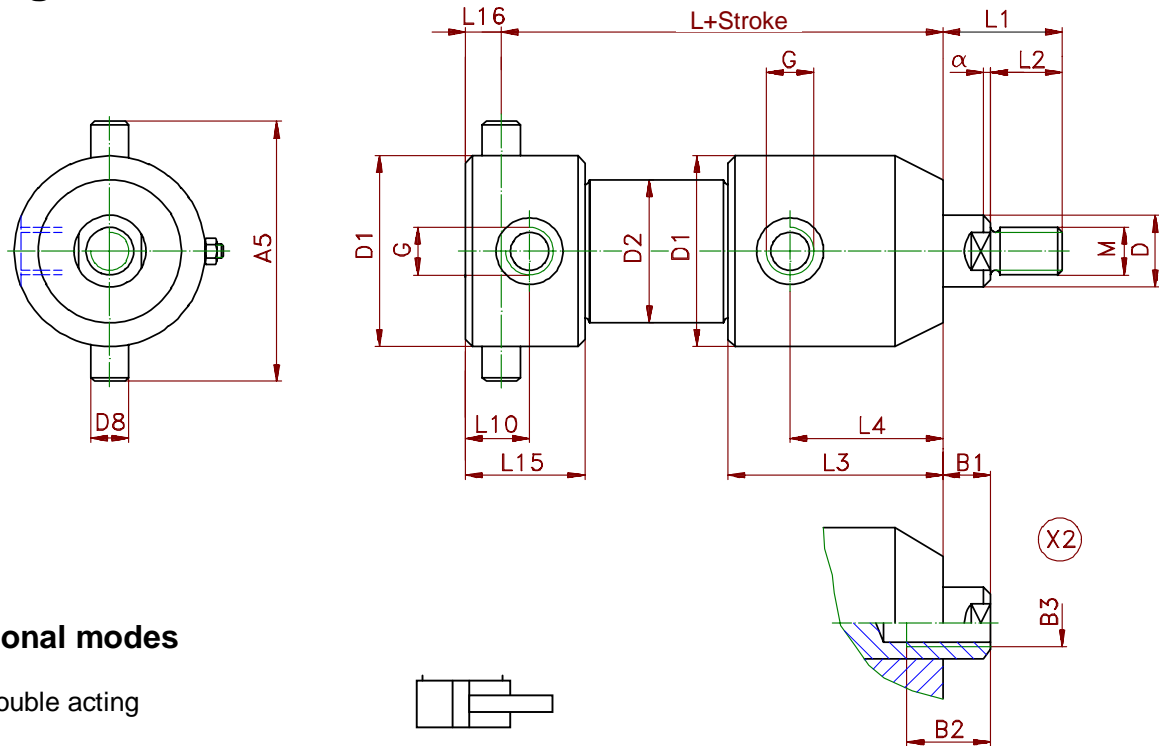

Functional modes

003 = double acting

004 = double acting with end-of-stroke damper on both sides

005 = double acting with end-of-stroke damper on rod side

006 = double acting with end-of-stroke damper on bottom side

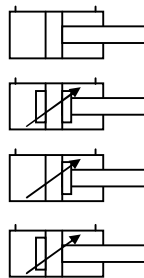

Piston rod end with female thread
Indicate required size when ordering
Or according to customers drawing

Kolben-ø	12	16	20	25	32	40	50	63	80	100	125	160	200
D rod ø	6	8	10	12	16	20	25	32	40	50	60	80	100
M	M5	M6	M8	M10	M14	M16	M20x1,5	M24x2	M35x1,5	M45x1,5	M58x1,5	M65x1,5	M80x2
D1	29	30	32	39	48	58	72	90	110	135	170	220	270
D2	18	22	25	30	38	48	60	75	92	115	145	190	245
D8 f7	5	6	8	10	14	16	20	25	40	50	60	70	80
L 003	65	66	73	85	89	104	111	122	151	179	237	335	385
L 004	85	86	103	125	129	144	161	162	191	229	317	435	505
L 005/006	75	76	88	105	109	124	136	142	171	204	277	385	445
L1	15	17	23	27	31	40	50	60	60	68	88	95	110
L2	10	12	14	16	20	25	30	40	35	45	58	65	80
L3	42	42	51	52	54	62	70	82	96	127	155	220	240
L4	23	23	25	26	28	35	40	48	55	75	95	145	145
L10	14	16	18	22	23	29	31	29	54	62	97	115	143
L15	32	34	44	50	50	60	61	62	97	110	160	190	240
L16	5	6	7	8	10	13	16	16	25	35	50	55	75
A5	39	42	48	59	76	90	112	140	190	240	290	360	430
G	G1/8"	G1/8"	G1/8"	G1/8"	G1/4"	G1/4"	G3/8"	G3/8"	G1/2"	G1/2"	G3/4"	G1"	G1"
α	0,5x45°	0,5x45°	0,5x45°	1,5x30°	2x30°	2x30°	2,5x30°	3x30°	3x30°	3x30°	4x30°	5x30°	6x30°

Design subject to change

Revision B * 15.11.1996 *K.E.

Standard Cylinder Series SZ 160



Configuration 117

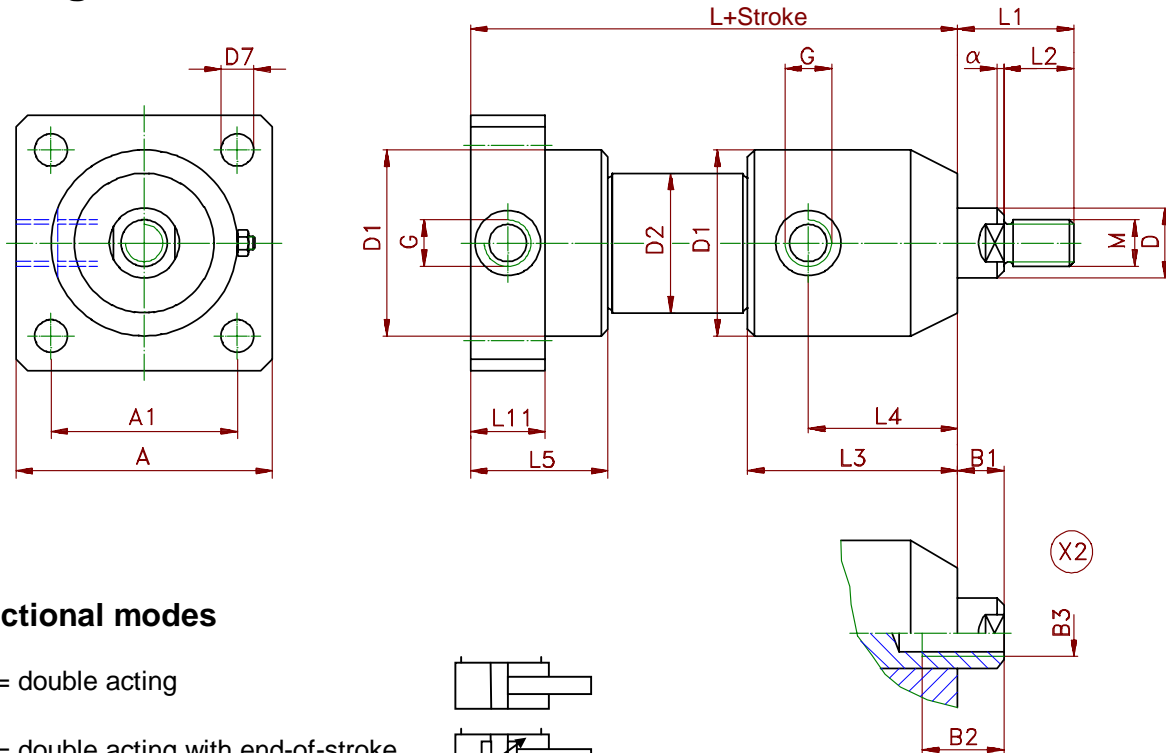

Functional modes

003 = double acting

004 = double acting with end-of-stroke damper on both sides

005 = double acting with end-of-stroke damper on rod side

006 = double acting with end-of-stroke damper on bottom side

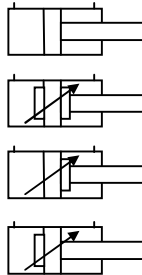

Piston rod end with female thread
Indicate required size when ordering
Or according to customers drawing

Piston-ø	12	16	20	25	32	40	50	63	80	100	125	160	200
D rod ø	6	8	10	12	16	20	25	32	40	50	60	80	100
M	M5	M6	M8	M10	M14	M16	M20x1,5	M24x2	M35x1,5	M45x1,5	M58x1,5	M65x1,5	M80x2
D1	29	30	32	39	48	58	72	90	110	135	170	220	270
D2	18	22	25	30	38	48	60	75	92	115	145	190	245
D7	6	6	7	7	9	11	13,5	13,5	17,5	17,5	30	39	45
L 003	64	64	70	82	87	100	111	126	138	171	212	300	340
L 004	84	84	100	122	127	140	161	166	178	221	292	400	460
L 005/006	74	74	85	102	107	120	136	146	158	196	252	350	400
L1	15	17	23	27	31	40	50	60	60	68	88	95	110
L2	10	12	14	16	20	25	30	40	35	45	58	65	80
L3	42	42	51	52	54	62	70	82	96	127	155	220	240
L4	23	23	25	26	28	35	40	48	55	75	95	145	145
L5	26	26	34	39	38	43	45	50	59	67	85	100	120
L11	16	16	16	22	22	25	26	30	32	35	40	50	50
A1	28	28	36	36	48	62	70	80	96	115	160	200	250
A	40	40	50	50	65	90	100	110	130	150	220	270	350
G	G1/8"	G1/8"	G1/8"	G1/8"	G1/4"	G1/4"	G3/8"	G3/8"	G1/2"	G1/2"	G3/4"	G1"	G1"
α	0,5x45°	0,5x45°	0,5x45°	1,5x30°	2x30°	2x30°	2,5x30°	3x30°	3x30°	3x30°	4x30°	5x30°	6x30°

Design subject to change

Revision B * 15.11.1996 *K.E.

()

()

Standard Cylinder Series SZ 160



Configuration 118

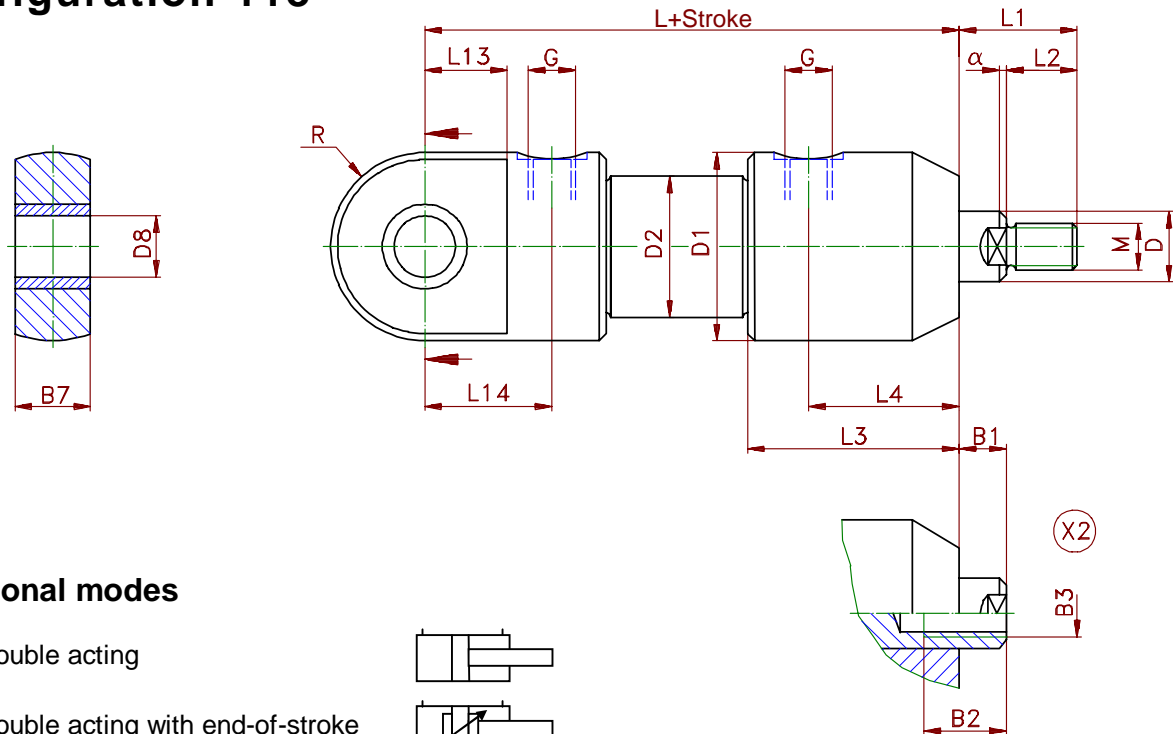

Functional modes

003 = double acting

004 = double acting with end-of-stroke damper on both sides

005 = double acting with end-of-stroke damper on rod side

006 = double acting with end-of-stroke damper on bottom side

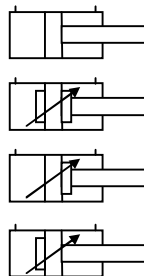

Piston rod end with female thread
Indicate required size when ordering
Or according to customers drawing

Piston-ø	12	16	20	25	32	40	50	63	80	100	125	160	200
D rod ø	6	8	10	12	16	20	25	32	40	50	60	80	100
M	M5	M6	M8	M10	M14	M16	M20x1,5	M24x2	M35x1,5	M45x1,5	M58x1,5	M65x1,5	M80x2
D1	29	30	32	39	48	58	72	90	110	135	170	220	270
D2	18	22	25	30	38	48	60	75	92	115	145	190	245
D8 H8	5	6	8	10	14	16	20	25	40	50	60	70	80
L 003	81	82	94	101	117	137	153	166	194	243	305	415	550
L 004	101	102	124	141	157	177	203	206	234	293	375	515	670
L 005/006	91	92	109	121	137	157	178	186	214	268	340	465	610
L1	15	17	23	27	31	40	50	60	60	67	88	95	110
L2	10	12	14	16	20	25	30	40	35	45	58	65	80
L3	42	42	51	52	54	62	70	82	96	125	155	220	240
L4	23	23	25	26	28	35	40	48	55	75	95	145	145
L13	15	15	20	20	25	32	38	40	50	65	90	115	141
L14	24	24	29	30	40	52	52	56	70	85	116	140	235
B7	8	8	10	12	15	20	25	32	50	60	80	90	100
R	15	15	16	19,5	20	25	28	35	50	60	70	82	90
G	G1/8"	G1/8"	G1/8"	G1/8"	G1/4"	G1/4"	G3/8"	G3/8"	G1/2"	G1/2"	G3/4"	G1"	G1"
α	0.5x45°	0.5x45°	0.5x45°	1,5x30°	2x30°	2x30°	2,5x30°	3x30°	3x30°	3x30°	4x30°	5x30°	6x30°

Design subject to change

Revision C * 20.01.2000 *K.E.

Standard Cylinder Series SZ 160

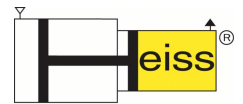

Configuration 218

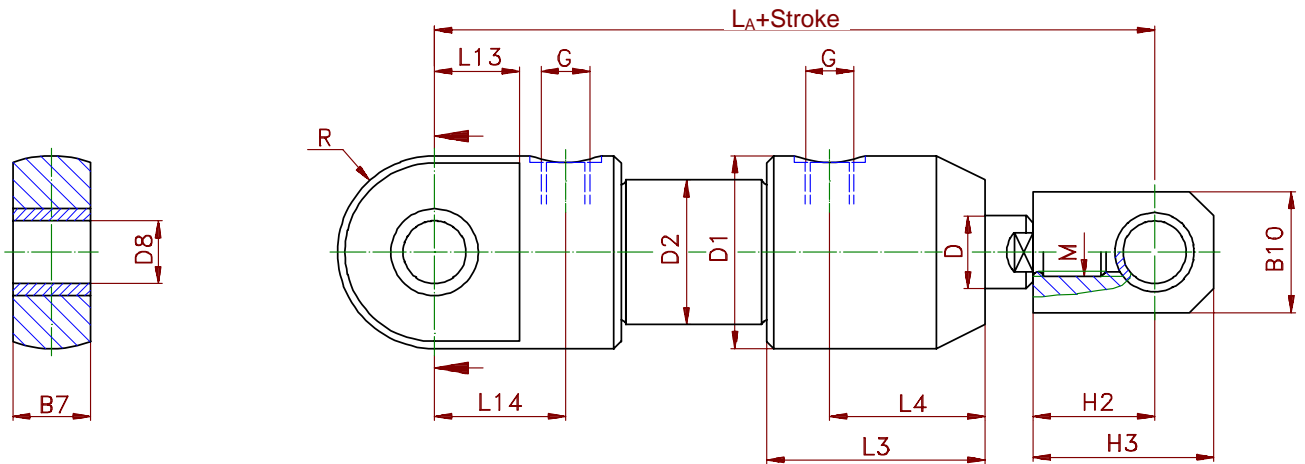

Functional modes

003 = double acting

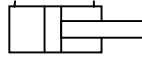

004 = double acting with end-of-stroke damper on both sides

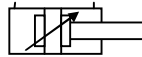

005 = double acting with end-of-stroke damper on rod side

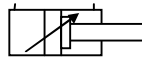

006 = double acting with end-of-stroke damper on bottom side

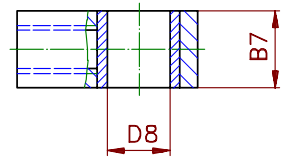
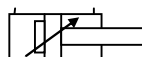

Piston-ø	12	16	20	25	32	40	50	63	80	100	125	160	200
D rod ø	6	8	10	12	16	20	25	32	40	50	60	80	100
M	M5	M6	M8	M10	M14	M16	M20x1,5	M24x2	M35x1,5	M45x1,5	M58x1,5	M65x1,5	M80x2
D1	29	30	32	39	48	58	72	90	110	135	170	220	270
D2	18	22	25	30	38	48	60	75	92	115	145	190	245
D8 H8	5	6	8	10	14	16	20	25	40	50	60	70	80
LA 003	104	105	123	137	156	187	213	236	299	365	445	565	720
LA 004	124	125	153	177	196	227	263	276	339	415	515	665	840
LA 005/006	114	115	138	157	176	207	238	256	319	390	480	615	780
L3	42	42	51	52	54	62	70	82	96	127	155	220	240
L4	23	23	25	26	28	35	40	48	55	75	95	145	145
L13	15	15	20	20	25	32	38	40	50	65	90	115	141
L14	24	24	29	30	40	52	52	56	70	85	116	140	235
B7	8	8	10	12	15	20	25	32	50	60	80	90	100
B10	15	20	20	20	25	30	40	50	80	100	120	140	160
H2	18	18	20	25	28	35	40	50	80	100	110	120	140
H3	25	28	30	35	40	50	60	75	120	150	180	190	220
R	15	15	16	19,5	20	25	28	35	50	60	70	82	90
G	G1/8"	G1/8"	G1/8"	G1/8"	G1/4"	G1/4"	G3/8"	G3/8"	G1/2"	G1/2"	G3/4"	G1"	G1"

Design subject to change

Revision C * 20.01.2000 *K.E.

Standard Cylinder Series SZ 160

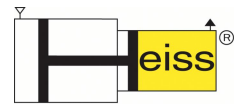

Configuration 119

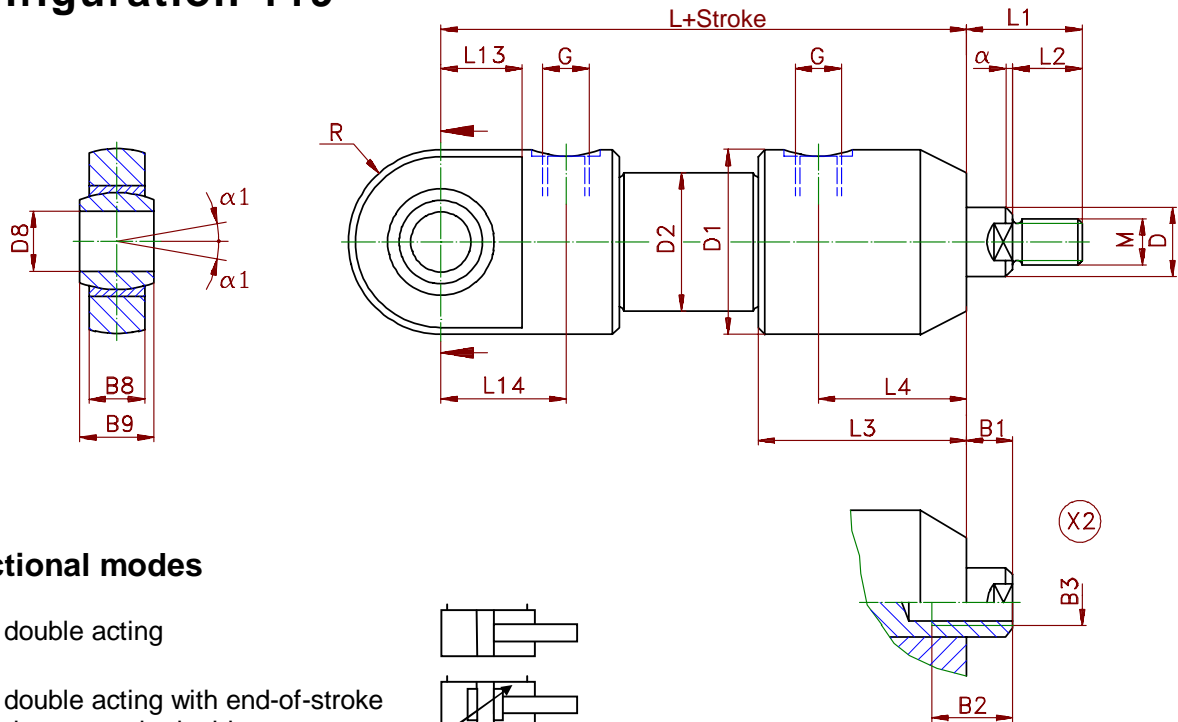

Functional modes

003 = double acting

004 = double acting with end-of-stroke damper on both sides

005 = double acting with end-of-stroke damper on rod side

006 = double acting with end-of-stroke damper on bottom side

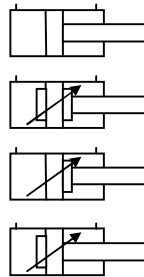

Piston rod end with female thread
Indicate desired size when ordering
Or according to customers drawing

Piston-ø	12	16	20	25	32	40	50	63	80	100	125	160	200
D rod ø	6	8	10	12	16	20	25	32	40	50	60	80	100
M	M5	M6	M8	M10	M14	M16	M20x1,5	M24x2	M35x1,5	M45x1,5	M58x1,5	M65x1,5	M80x2
D1	29	30	32	39	48	58	72	90	110	135	170	220	270
D2	18	22	25	30	38	48	60	75	92	115	145	190	245
D8 H8	5	6	8	10	15	17	20	25	40	50	60	70	80
L 003	81	82	94	101	117	137	153	166	194	243	305	415	550
L 004	101	102	124	141	157	177	203	206	234	293	375	515	670
L 005/006	91	92	109	121	137	157	178	186	214	268	340	465	610
L1	15	17	23	27	31	40	50	60	60	67	88	95	110
L2	10	12	14	16	20	25	30	40	35	45	58	65	80
L3	42	42	51	52	54	62	70	82	96	127	155	220	240
L4	23	23	25	26	28	35	40	48	55	75	95	145	145
L13	15	15	20	20	25	32	38	40	50	65	90	115	141
L14	24	24	29	30	40	52	52	56	70	85	116	140	235
B8	6	4	5	6	9	10	12	16	22	28	36	40	45
B9	8	6	8	9	12	14	16	20	28	35	44	49	55
R	15	15	16	19,5	20	25	28	35	50	60	70	82	90
G	G1/8"	G1/8"	G1/8"	G1/8"	G1/4"	G1/4"	G3/8"	G3/8"	G1/2"	G1/2"	G3/4"	G1"	G1"
α1	13°	13°	15°	12°	8°	10°	9°	7°	7°	6°	6°	6°	6°
α	0,5x45°	0,5x45°	0,5x45°	1,5x30°	2x30°	2x30°	2,5x30°	3x30°	3x30°	3x30°	4x30°	5x30°	6x30°

Design subject to change

Revision C * 20.01.2000 *K.E.

Standard Cylinder Series SZ 160



Configuration 219

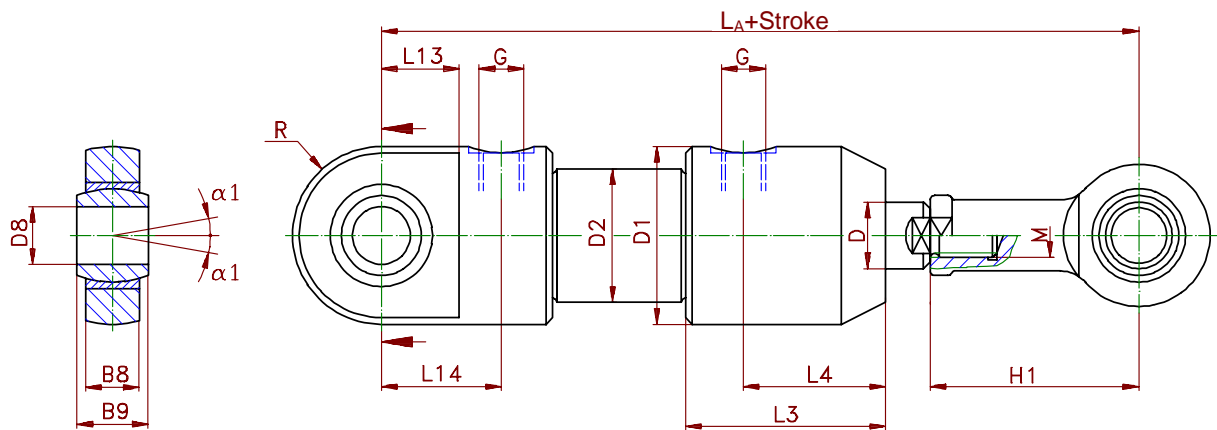

Swivel head GK
piston-ø range 16 - 63

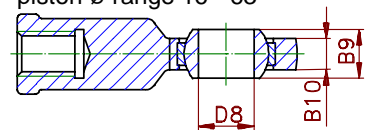

Swivel head GKA
piston-ø range 80 - 200

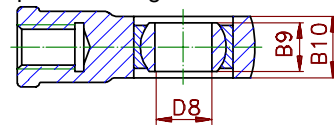

Functional modes

003 = double acting

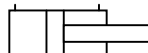

004 = double acting with end-of-stroke damper on both sides

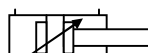

005 = double acting with end-of-stroke damper on rod side

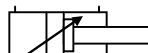

006 = double acting with end-of-stroke damper on bottom side

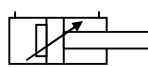

See dimension sheets for swivel heads

Piston-ø	12	16	20	25	32	40	50	63	80	100	125	160	200
D rod ø	6	8	10	12	16	20	25	32	40	50	60	80	100
M	M5	M6	M8	M10	M14	M16	M20x1,5	M24x2	M35x1,5	M45x1,5	M58x1,5	M65x1,5	M80x2
D1	29	30	32	39	48	58	72	90	110	135	170	220	270
D2	18	22	25	30	38	48	60	75	92	115	145	190	245
D8 H8	5	6	8	10	15	17	20	25	40	50	60	70	80
LA 003	113	117	139	155	189	219	250	280	304	370	465	595	750
LA 004	133	137	169	195	229	259	300	320	344	420	535	695	870
LA 005/006	123	127	154	175	209	239	275	300	324	395	500	645	810
L3	42	42	51	52	54	62	70	82	96	127	155	220	240
L4	23	23	25	26	28	35	40	48	55	75	95	145	145
L13	15	15	20	20	25	32	38	40	50	65	90	115	141
L14	24	24	29	30	40	52	52	56	70	85	116	140	235
B8	6	4	5	6	9	10	12	16	22	28	36	40	45
B9	8	6	8	9	12	14	16	20	28	35	44	49	55
B10	6	4,5	6	7	10	11	13	17	35	40	50	55	60
H1	27	30	36	43	61	67	77	94	85	105	130	150	170
R	15	15	16	19,5	20	25	28	35	50	60	70	82	90
G	G1/8"	G1/8"	G1/8"	G1/8"	G1/4"	G1/4"	G3/8"	G3/8"	G1/2"	G1/2"	G3/4"	G1"	G1"
α1	13°	13°	15°	12°	8°	10°	9°	7°	7°	6°	6°	6°	6°

Design subject to change

Revision C * 20.01.2000 *K.E.

Standard Cylinder Series SZ 160



Configuration 120 - Nondifferential cylinder -

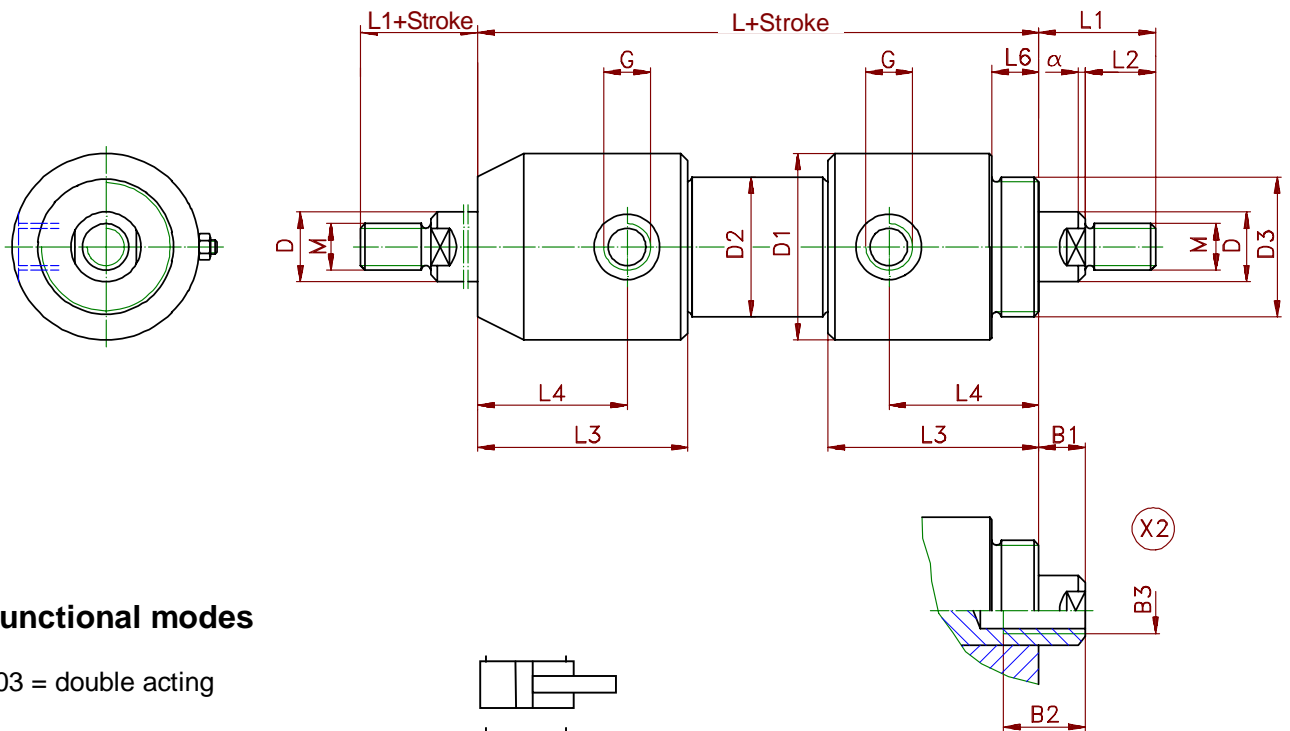

Functional modes

003 = double acting

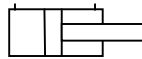

004 = double acting with end-of-stroke damper on both sides

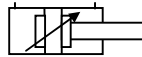

005 = double acting with end-of-stroke damper on rod side

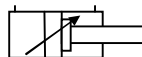

006 = double acting with end-of-stroke damper on bottom side

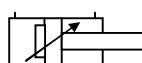

Piston rod end with female thread
Indicate desired size when ordering
Or according to customers drawing

The nondifferential cylinder can be combined with all other attachment methods!

Piston-ø	12	16	20	25	32	40	50	63	80	100	125	160	200
D rod ø	6	8	10	12	16	20	25	32	40	50	60	80	100
M	M5	M6	M8	M10	M14	M16	M20x1,5	M24x2	M35x1,5	M45x1,5	M58x1,5	M65x1,5	M80x2
D1	29	30	32	39	48	58	72	90	110	135	170	220	270
D2	18	22	25	30	38	48	60	75	92	115	145	190	245
D3	M16x1,5	M20x1,5	G 1/2"	G 3/4"	G 1"	G 1 1/4"	G 1 1/2"	G 2"	G 2 1/2"	G 3"	M125x3	M180x3	M200x3
L 003	80	80	87	95	103	119	136	158	175	231	282	420	460
L 004	100	100	117	135	143	159	186	198	215	281	362	520	580
L 005/006	90	90	102	115	123	139	161	178	195	256	322	470	520
L1	15	17	23	27	31	40	50	60	60	70	88	95	110
L2	10	12	14	16	20	25	30	40	35	45	58	65	80
L3	42	42	51	52	54	62	70	82	96	127	155	220	240
L4	23	23	25	26	28	35	40	48	55	75	95	145	145
L6	8	8	9	9	11	14	16	20	25	35	40	48	68
G	G1/8"	G1/8"	G1/8"	G1/8"	G1/4"	G1/4"	G3/8"	G3/8"	G1/2"	G1/2"	G3/4"	G1"	G1"
α	0,5x45°	0,5x45°	0,5x45°	1,5x30°	2x30°	2x30°	2,5x30°	3x30°	3x30°	3x30°	4x30°	5x30°	6x30°

Design subject to change

Revision B * 15.11.1996 *K.E.

Standard Cylinder Series SZ 160

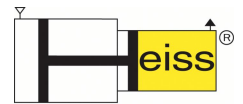

Configuration 120-1

- Nondifferential cylinder with stroke adjustment -

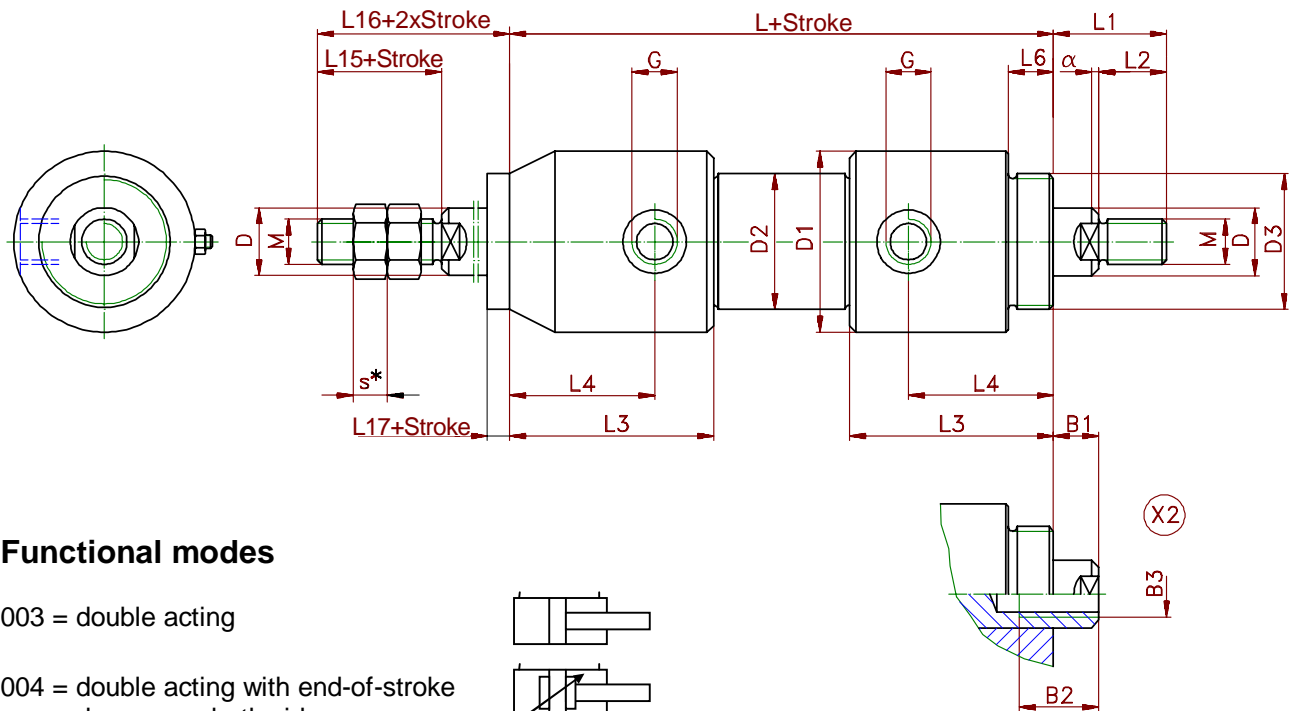

Functional modes

003 = double acting

004 = double acting with end-of-stroke damper on both sides

005 = double acting with end-of-stroke damper on rod side

006 = double acting with end-of-stroke damper on bottom side

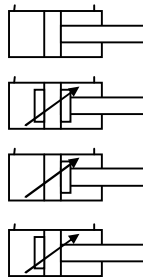

Piston rod end with female thread
Indicate desired size when ordering
Or according to customers drawing

The nondifferential cylinder can be combined with all other attachment methods!

Kolben-ø	12	16	20	25	32	40	50	63	80	100	125	160	200
D rod ø	6	8	10	12	16	20	25	32	40	50	60	80	100
M	M5	M6	M8	M10	M14	M16	M20x1,5	M24x2	M35x1,5	M45x1,5	M58x1,5	M65x1,5	M80x2
D1	29	30	32	39	48	58	72	90	110	135	170	220	270
D2	18	22	25	30	38	48	60	75	92	115	145	190	245
D3	M16x1,5	M20x1,5	G 1/2"	G 3/4"	G 1"	G 1 1/4"	G 1 1/2"	G 2"	G 2 1/2"	G 3"	M125x3	M180x3	M200x3
L 003	80	80	87	95	103	119	136	158	175	231	282	420	460
L 004	100	100	117	135	143	159	186	198	215	281	362	520	580
L 005/006	90	90	102	115	123	139	161	178	195	256	322	470	520
L1	15	17	23	27	31	40	50	60	60	70	88	95	110
L2	10	12	14	16	20	25	30	40	35	45	58	65	80
L3	42	42	51	52	54	62	70	82	96	127	155	220	240
L4	23	23	25	26	28	35	40	48	55	75	95	145	145
L6	8	8	9	9	11	14	16	20	25	35	40	48	68
L15	15	15	20	20	25	30	35	45	60	70	80	90	100
L16	20	20	25	27	32	40	50	60	85	95	115	125	140
L17	8	8	10	12	12	15	20	25	35	40	50	55	60
s*	4	5	6,5	8	11	13	13	19	25	30	36	40	45
G	G1/8"	G1/8"	G1/8"	G1/8"	G1/4"	G1/4"	G3/8"	G3/8"	G1/2"	G1/2"	G3/4"	G1"	G1"
α	0,5x45°	0,5x45°	0,5x45°	1,5x30°	2x30°	2x30°	2,5x30°	3x30°	3x30°	3x30°	4x30°	5x30°	6x30°

Design subject to change

Revision B * 15.11.1996 *K.E.

()

()

Standard Cylinder Series SZ 160



Configuration 125

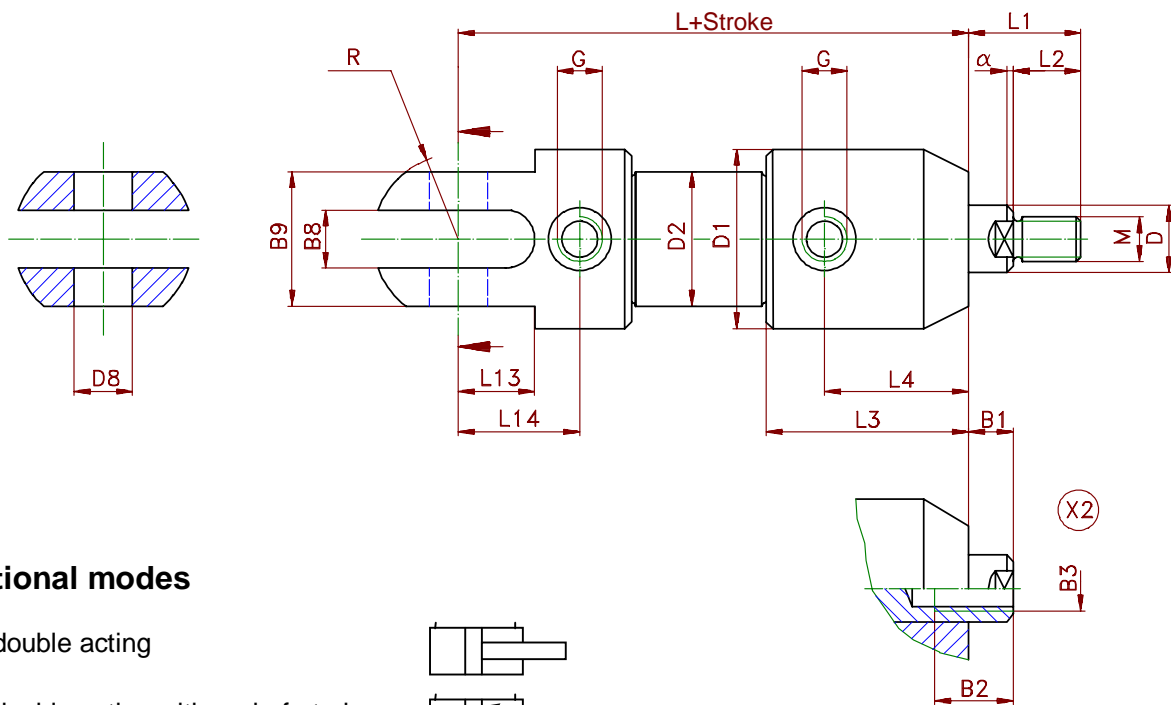

Functional modes

003 = double acting

004 = double acting with end-of-stroke damper on both sides

005 = double acting with end-of-stroke damper on rod side

006 = double acting with end-of-stroke damper on bottom side

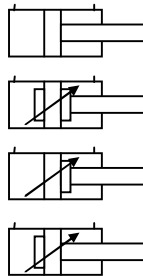

Piston rod end with female thread
Indicate desired size when ordering
Or according to customers drawing

Piston-ø	12	16	20	25	32	40	50	63	80	100	125	160	200
D rod ø	6	8	10	12	16	20	25	32	40	50	60	80	100
M	M5	M6	M8	M10	M14	M16	M20x1,5	M24x2	M35x1,5	M45x1,5	M58x1,5	M65x1,5	M80x2
D1	29	30	32	39	48	58	72	90	110	135	170	220	270
D2	18	22	25	30	38	48	60	75	92	115	145	190	245
D8 H8	5	6	8	10	14	16	20	25	40	50	60	70	80
L 003	81	82	94	101	117	137	153	166	194	243	305	415	550
L 004	101	102	124	141	157	177	203	206	234	293	375	515	670
L 005/006	91	92	109	121	137	157	178	186	214	268	340	465	610
L1	15	17	23	27	31	40	50	60	60	67	88	95	110
L2	10	12	14	16	20	25	30	40	35	45	58	65	80
L3	42	42	51	52	54	62	70	82	96	127	155	220	240
L4	23	23	25	26	28	35	40	48	55	75	95	145	145
L13	15	15	20	20	25	32	38	45	55	68	100	115	160
L14	24	24	29	30	40	52	52	56	70	82	116	140	235
B8	5	6	8	10	14	16	20	25	40	40	50	55	60
B9	14	16	22	26	32	38	46	60	90	110	140	150	160
R	15	15	16	19,5	24	29	36	45	55	67,5	72	110	135
G	G1/8"	G1/8"	G1/8"	G1/8"	G1/4"	G1/4"	G3/8"	G3/8"	G1/2"	G1/2"	G3/4"	G1"	G1"
α	0,5x45°	0,5x45°	0,5x45°	1,5x30°	2x30°	2x30°	2,5x30°	3x30°	3x30°	3x30°	4x30°	5x30°	6x30°

Design subject to change

Revision C * 22.07.2005 *K.E.

Standard Cylinder Series SZ 160



Configuration 225

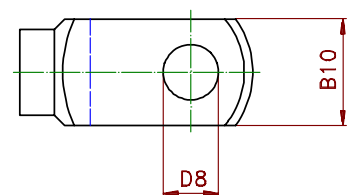
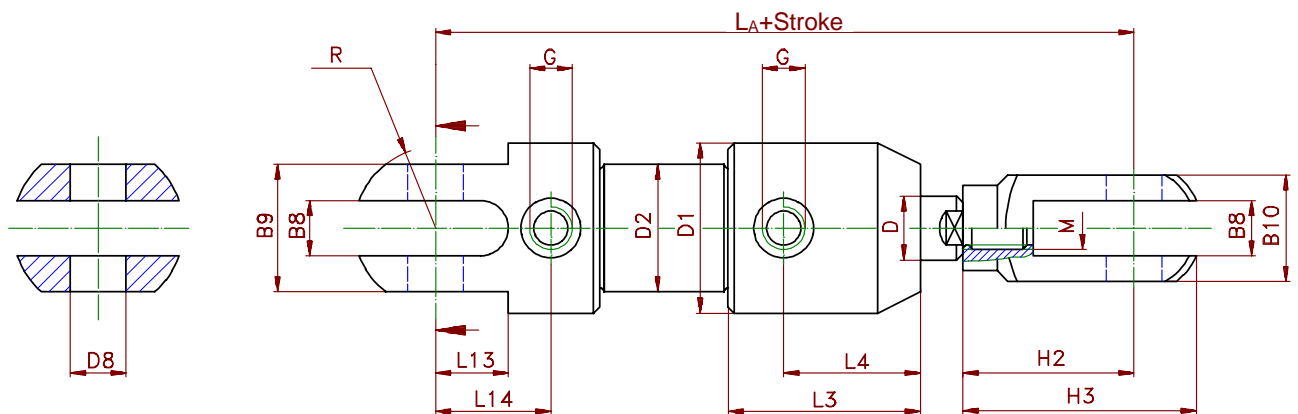

Functional modes

003 = double acting

004 = double acting with end-of-stroke damper on both sides

005 = double acting with end-of-stroke damper on rod side

006 = double acting with end-of-stroke damper on bottom side

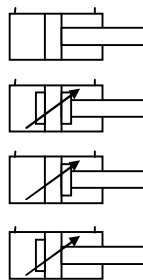

Piston-ø	12	16	20	25	32	40	50	63	80	100	125	160	200
D rod ø	6	8	10	12	16	20	25	32	40	50	60	80	100
M	M5	M6	M8	M10	M14	M16	M20x1,5	M24x2	M35x1,5	M45x1,5	M58x1,5	M65x1,5	M80x2
D1	29	30	32	39	48	58	72	90	110	135	170	220	270
D2	18	22	25	30	38	48	60	75	92	115	145	190	245
D8 H8	5	6	8	10	14	16	20	25	40	50	60	70	80
LA 003	106	111	131	147	176	206	238	266	351	395	475	605	765
LA 004	126	131	161	187	216	246	288	306	391	445	545	705	885
LA 005/006	116	121	146	167	196	226	263	286	371	420	510	655	825
L3	42	42	51	52	54	62	70	82	96	127	155	220	240
L4	23	23	25	26	28	35	40	48	55	75	95	145	145
L13	15	15	20	20	25	32	38	45	55	68	100	115	160
L14	24	24	29	30	40	52	52	56	70	82	116	140	235
B8	5	6	8	10	14	16	20	25	40	40	50	55	60
B9	14	16	22	26	32	38	46	60	90	110	140	150	160
B10	10	12	16	20	27	32	40	50	85	100	130	140	150
H2	20	24	28	35	48	54	65	80	132	130	140	160	185
H3	26	31	38	47	64	73	90	112	196	195	210	230	260
R	15	15	16	19,5	24	29	36	45	55	67,5	72	110	135
G	G1/8"	G1/8"	G1/8"	G1/8"	G1/4"	G1/4"	G3/8"	G3/8"	G1/2"	G1/2"	G3/4"	G1"	G1"

Design subject to change

Revision C * 22.07.2005 *K.E.

Piston force diagram



Formulas for calculation:

• of piston force on piston side: (pushing)
$$F = \frac{p \cdot D^2 \cdot \pi}{40000}$$

• of piston force on rod side: (pulling)
$$F = \frac{p \cdot (D^2 - d^2) \cdot \pi}{40000}$$

• of the required piston-ø :
$$D_{\text{erf}} = \sqrt{\frac{F \cdot 40000}{p \cdot \pi}}$$

• of the required operating pressure:
$$p_{\text{erf}} = \frac{F \cdot 40000}{\pi \cdot D^2}$$

F ... piston force [kN]

p ... operating press. [bar]

D ... piston-ø [mm]

d ... rod-ø [mm].

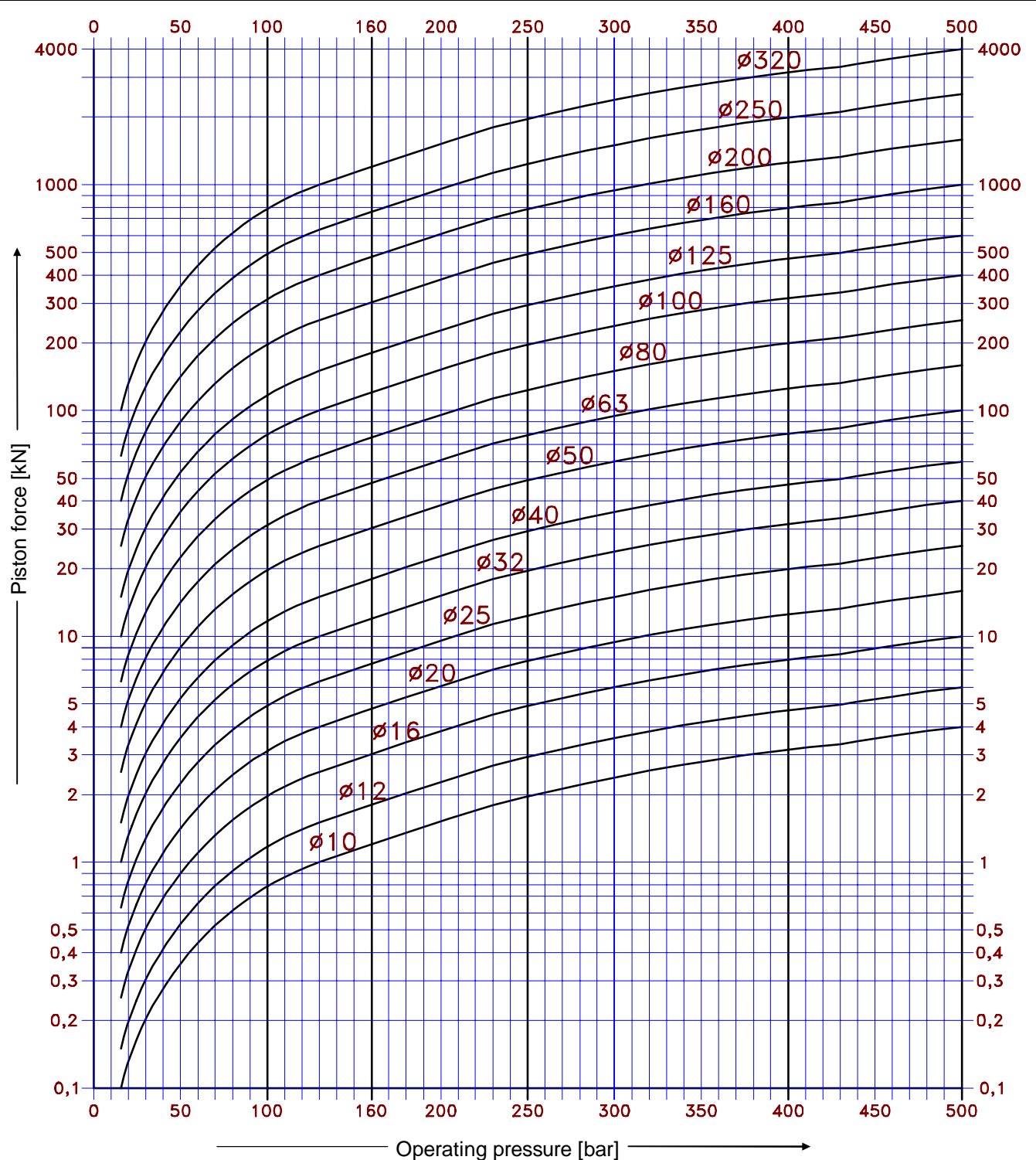

Revision B * 15.11.1996 *K.E.

()

()

Load/buckling diagram

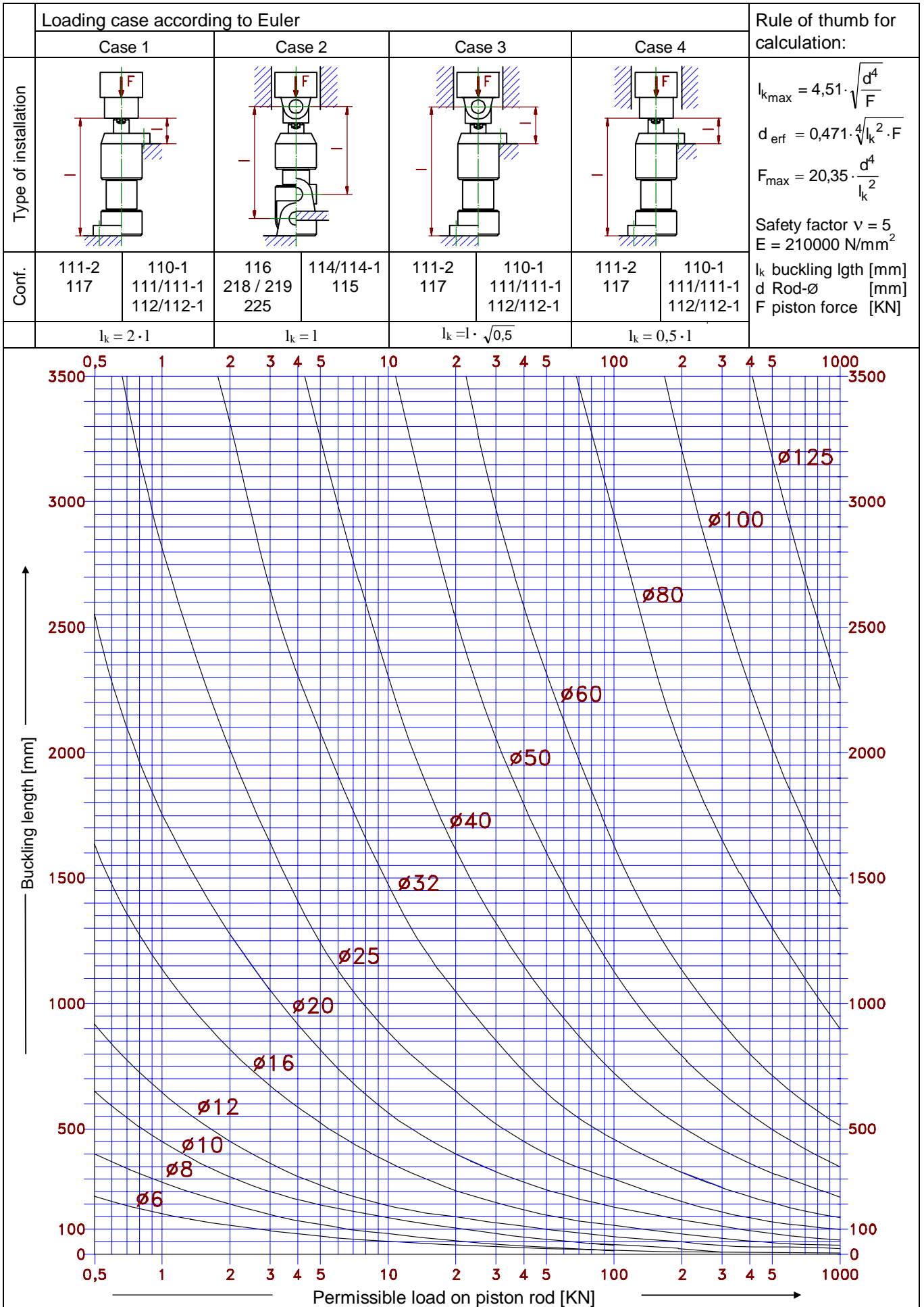

Type designation



Description:

SZ 160 - 50 / 25 / 200 - 112 . 003 . X

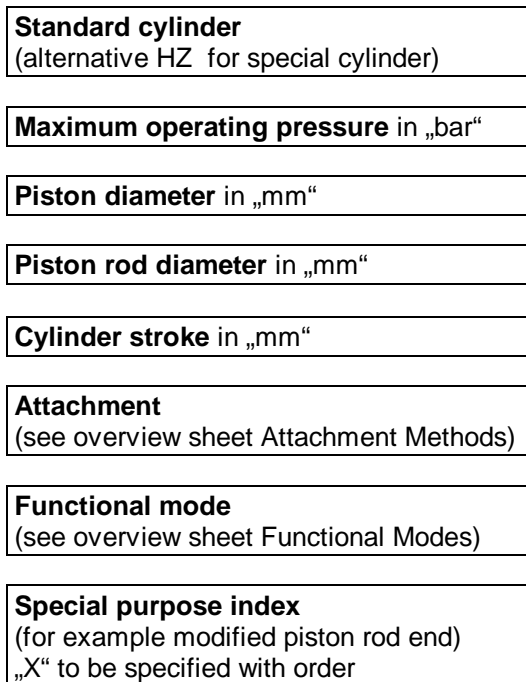

Examples for ordering:

SZ 160 - 32 / 16 / 85 - 117 . 003

Standard cylinder for operating pressure of 160 bar
 Piston diameter: 32 mm
 Piston rod diameter: 16 mm
 Cylinder stroke: 85 mm
 Flange attachment on bottom side
 Double acting

SZ 160 - 63 / 32 / 400 - 111 - 120 . 004

Standard cylinder for operating pressure of 160 bar
 Piston diameter: 63 mm
 Piston rod diameter: 32 mm
 Cylinder stroke: 400 mm
 Thread attachment
 Nondifferential cylinder
 Double acting with end-of-stroke damper on both sides

SZ 160 - 125 / 60 / 1200 - 115 . 006 . X2

L12 = 375

B1 = 40

B2 = 50

B3 = M 45x1,5

Standard cylinder for operating pressure of 160 bar
 Piston diameter: 125 mm
 Piston rod diameter: 60 mm
 Cylinder stroke: 1200 mm
 Pivot pin attachment at cylinder tube, distance from pivot pin center to cylinder head 375 mm
 Double acting with end-of-stroke damper on bottom side
 Piston rod with female thread M45x1,5; 50mm deep, piston rod excess end 40mm