

F5 Feedback unit

Product
Information

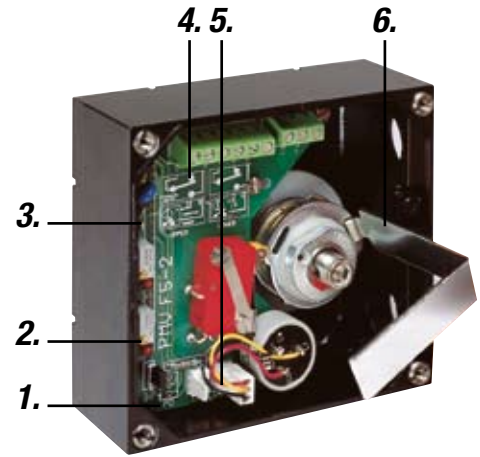

1. Jumper for field selection of 90, 60, 45 and 30 deg, operation for 4–20 mA position transmitter.
2. LEDs indicate 4 and 20 mA output.
3. Test outlet for 4–20 mA position transmitter.
4. Info printed on the PC board.
5. Field selectable direction of 4–20 mA of output signal, direct or reverse.
6. Easy to set cams with no fixed increments for true 100% resolution.



F5 Feedback Unit

F5/F5-EX

- Mounts on P5/EP5 without additional mounting bracket.
- Bright visible, flat or dome position indicator.
- Easy to set stepless cams – 100% resolution.
- Switches, mechanical or proximity, P+F Namur sensors.
- Potentiometer or 4–20 mA position transmitter.
- Sturdy, reliable and simple design.
- Explosion proof or intrinsically safe enclosure.
- ATEX, CSA and FM approvals



Easy to install



Install coupling



Place F5 unit on top, tighten screws



Install indicator and cover



Technical data

General

| | |
|-------------------|--|
| Conduit entries | 2x1/2 NPT or 2xPG 13.5 (M20) |
| Housing material | Die cast aluminum |
| Surface treatment | ED painting |
| Weight | 0,7 kg (lbs 1,5) Ex proof = 2,1 kg (lbs 4,6) |
| Mounting | Direct on P5/EP5 and VDI/VDE 3845 |
| Fasteners | Stainless A2/A4 |
| Terminals | 2,5 mm ² (AWG 14) Screw terminals |
| Enclosure | IP66, NEMA 4 |
| Temp* | -40°C to 85°C (-40°F to 185°F) |

Switches, mechanical

| | |
|--------|--------------------|
| Type | Mechanical SPDT V3 |
| Rating | 6/2,5A 250 V AC |

NAMUR sensors

| | |
|---------------|-------------------------------|
| Type | P+F NJ2 V3N |
| Load Current | ≤ 1 mA ≥ 3 mA |
| Voltage range | 5-25 V DC |
| Hysteresis | 0,2% |
| Temp | -25°C to 85°C (-4°F to 185°F) |

Proximity switches

| | |
|--------------------------------|--------------------------------------|
| Contact rating | 2 W or 2 VA @ 30 V DC/V AC, 0.1 A |
| Maximum operating time | 0.5 milliseconds |
| Breakdown voltage | 200 V DC |
| Contact resistance | 0.2 Ohms |
| Switch type | SPDT hermetically sealed in one unit |
| Mechanical and electrical life | > 10 million operations |

Potentiometer

| | |
|---------------------|----------------------|
| Output | 5kΩ (4kΩ at 90°) |
| Elements | Conductive plastic |
| Power rating at 70° | 1 W |
| Linearity | 1% |
| Resolution | Essentially infinite |

4-20 mA position transmitter

| | |
|-------------------------|---------------------|
| Power supply | Max. 28 V DC |
| Output signal | 4-20 mA |
| LED indication at 4 mA | ±1% |
| LED indication at 20 mA | ±1% |
| Resolution | Infinite |
| Minimum rotation travel | 30° |
| Maximum rotation travel | 90° (270° option) |
| Linearity | <1% of full scale |
| Hysteresis | <0,5% of full scale |
| Output current limit | 24 mA DC |
| Load impedance | 800Ω at 24 V DC |

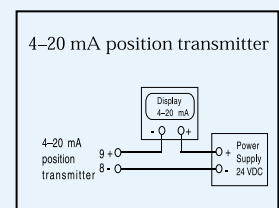
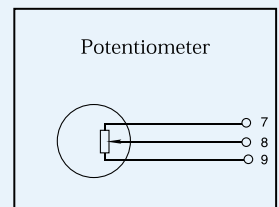
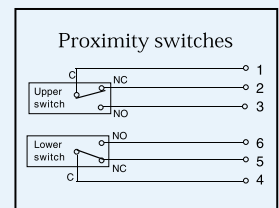
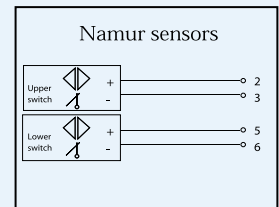
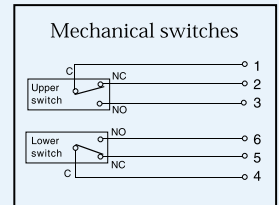

* Not NAMUR sensors



Modular



F5 mounted on actuator for on/off applications



F5 mounted on positioner P5



F5 mounted on positioner EP5

F5 Series Coding

Model (for installation on P5/EP5 only)
 F5G P5 with PG 13.5 connections
 F5N P5 with NPT 1/2" connections

Surface treatment
 U Epoxy, ED
 M Tufram

Switches
 MEC 2 x SPDT switches
 NAM 2 x P+F Namur Sensors
 PXY 2 x Proximity switches

Feedback
 XXX None
 POT Potentiometer 5 kOhm
 P1K Potentiometer 1 kOhm
 P18 Potentiometer 180 deg
 420 4-20 mA transmitter
 T18 4-20 mA transmitter, 180 deg
 T27 4-20 mA transmitter, 270 deg

Spindle
 00 Drive coupling for P5/EP5

Seals
 N Nitrile, NBR

Model
 F5IS F5 Intrinsically safe
 F5EX F5 Explosion proof

Electrical connections
 G PG13.5, Not F5EX
 N 1/2" NPT

Surface treatment
 U Epoxy, ED
 M Tufram

Switches
 MEC 2 x SPDT switches
 NAM 2 x P+F Namur Sensors
 PXY 2 x Proximity switches

Feedback
 XXX None
 POT Potentiometer 5 kOhm
 P1K Potentiometer 1 kOhm
 P18 Potentiometer 180 deg
 420 4-20 mA transmitter
 T18 4-20 mA transmitter, 180 deg
 T27 4-20 mA transmitter, 270 deg

Spindle
 00 Drive coupling for P5/EP5
 23 01 to 39, see dwg SPNDLS_P5

Frontcover, indicator
 PV9DA 90 deg, direct arrow indicator
 PV3RH 30 deg, reverse, Dome indicator

Seals
 N Nitrile, NBR

Example
 F5ISNU-MEC420-00-PV9DA-Z

(*For 30, 45, 60 deg rotation, change PV9 to PV3, PV4 or PV6 D=direct, R=reverse, A=arrow indicator, B=blind, H=dome)

Dimensions drawings(mm)

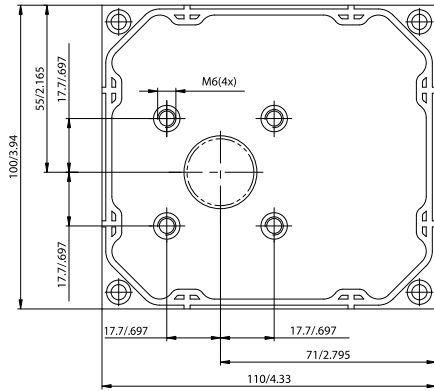

F5

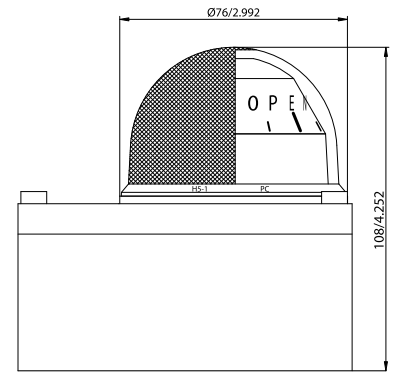
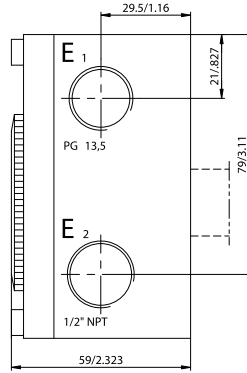

F5 with Dome H5

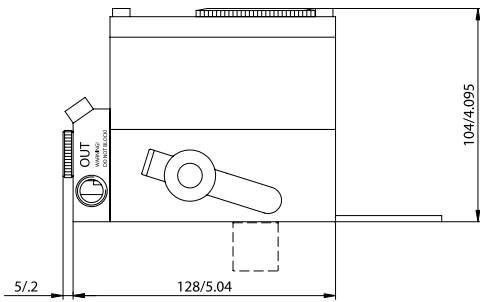

F5 on EP5

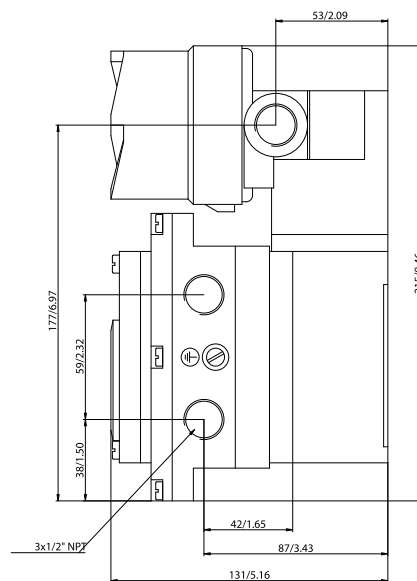

F5EX on EP5EX

