

FEATURE HIGHLIGHTS

PRECISION



- Precision class 0.1%
- Resolution @ 14 bit

PRECISION

CONFIGURATION

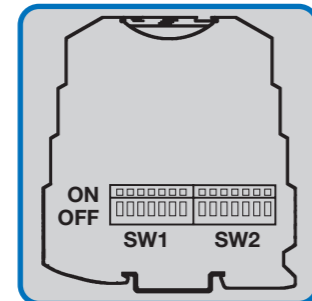

- Setup via DIP Switches

CONFIGURATION

ISOLATION

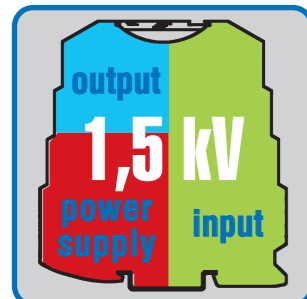

- Digital Optocoupler
- 3 way isolation @ 1,5 kVAc (50 Hz, 1min)
- Digital decoupling of input signal
- Protection circuit against output overcurrent

ISOLATION

DIMENSIONS

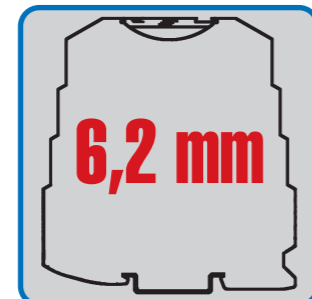

- Tiny dimensions
- 6,2 mm width

DIMENSIONS

RELIABILITY

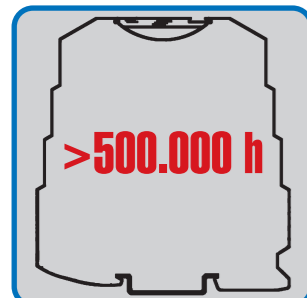

- High MTBF
- 160 components

RELIABILITY

POWER SUPPLY



- Direct supply on the spring-cage terminal block
- Distributed SMART SUPPLY by 2 slots K-BUS and K-SUPPLY

POWER SUPPLY

CONNECTIONS

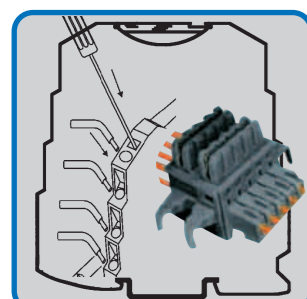

- Cage clamp connectors
- Expandable K-bus connector on DIN rail guide 35 mm

CONNECTIONS

CONSUMPTION



- Max current consumption: 25 mA (24 Vdc)
- Current consumption without load at 25°C: 7,5 mA
- Max power consumption: 500 mW

CONSUMPTION

POWER SUPPLY TECHNIQUES

K Line signal conditioners can be powered in 3 different ways: by the spring-cage terminal block (24 Vdc direct from power supply) or by SMART SUPPLY system. SMART SUPPLY system is based on expandable KBUS connector. Up to 16 devices, the distribution of power supply is possible connecting a single device at voltage source, as whole consumption doesn't exceed 400 mA. Over 16 and up to 75 devices, with maximum current consumption of 1,6 A (approx 21 mA per module), it's needed K-SUPPLY module that gets overvoltages protections on-board.

POWER SUPPLY ON SPRING-CAGE TERMINAL

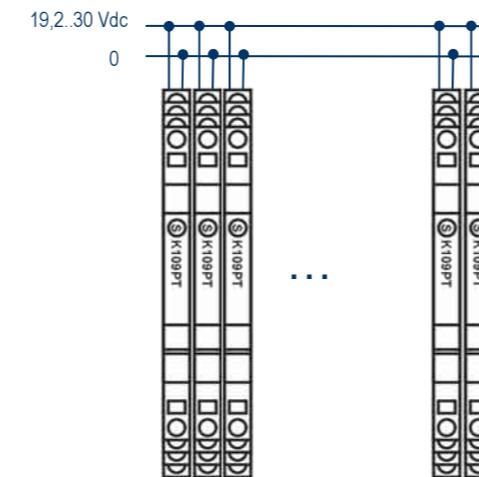

1

SMART SUPPLY SYSTEM

Distributed supply with 2 slot connector K-BUS (up to 16 modules)

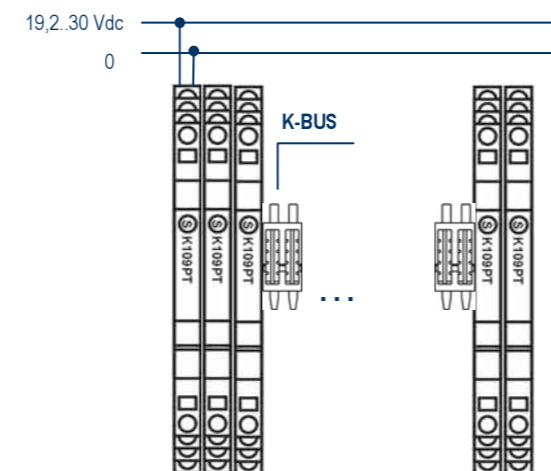

2

SMART SUPPLY SYSTEM

Distributed supply with K-SUPPLY module and K-BUS (up to 75 modules)

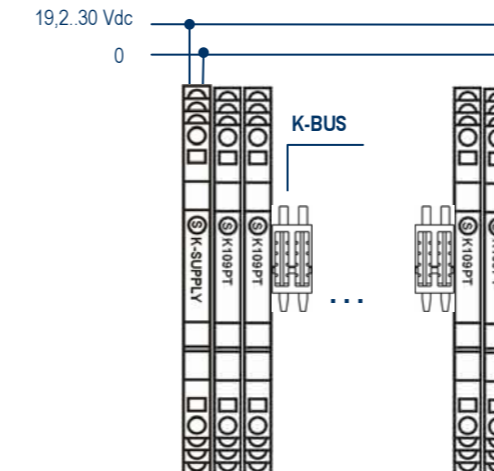

3

ORDER CODES AND CONFIGURATIONS

DESCRIPTION	VERSIONS / ORDER CODE
Pt100 converter	K109PT100
Pt1000 converter	K109PT1000
Thermocouple converter with settable threshold	K109TC
Galvanic isolator - voltage / current converter	K109UI
Galvanic isolator with active output	K109S
Shunt converter	K109SH
RS485 / RS485 serial repeater	K107A
RS232 / RS485 serial converter	K107B
RS485 / USB serial converter	K107USB
Expandable power supply connector	K-BUS
Power Supply module with surge protection	K-SUPPLY

K-LINE

Compact converters 6,2 mm normalized case

- GALVANIC ISOLATION
- TEMPERATURE CONVERSION
- ANALOGUE CONVERSION
- SERIAL CONVERSION

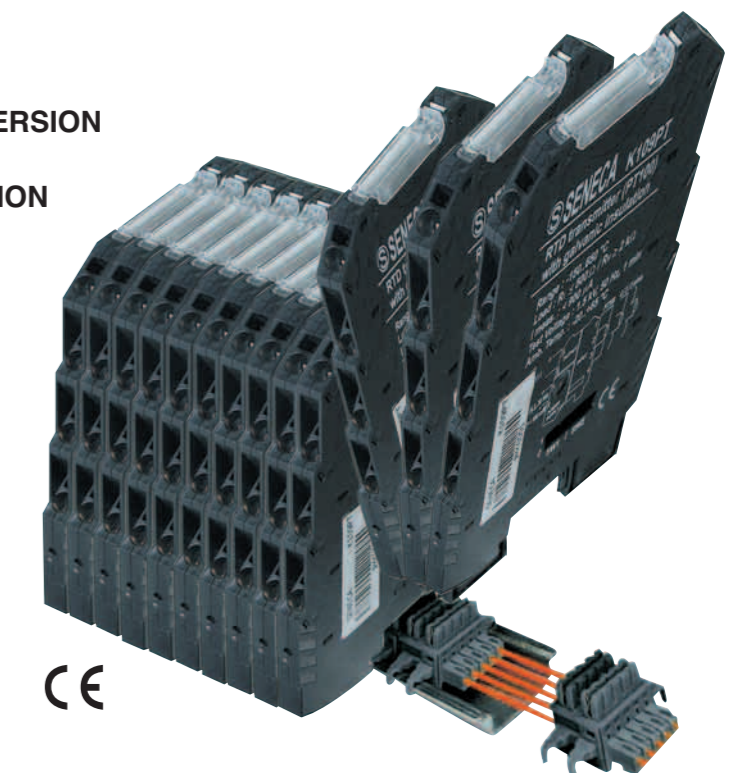

CE

- ▶ Resolution @ 14 bit
- ▶ Precision class 0.1%
- ▶ 3 way isolation
- ▶ Tiny dimensions (102,5 x 93,1 x 6,2 mm)
- ▶ Spring-cage terminal block and/or DIN bus connection system
- ▶ Power bridging terminal - DIN rail bus connector
- ▶ Easy installation and maintenance
- ▶ Setup via DIP Switches
- ▶ Low power consumption
- ▶ Digital decoupling of input signal
- ▶ Protection circuit against output overcurrent

DIMENSIONS

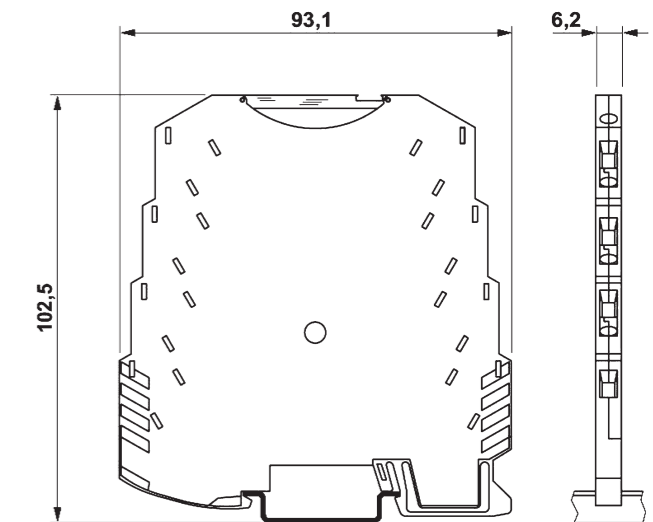

TECHNICAL FEATURES

	K109PT	K109PT1000	K109TC	K109UI	K109S
Channels	1 input, 1 output	1 input, 1 output	1 input, 2 outputs	1 input, 1 output	1 input, 1 output
Precision	0,1 %	0,1 %	0,1 %	0,1 %	0,1 %
Thermal drift	< 100 ppm/K	< 120 ppm/K	< 120 ppm/K	< 120 ppm/K	< 120 ppm/K
LED	• Fault / alarm	• Fault / alarm	• Fault / alarm • Threshold setting • Static relay output status	• Fault / alarm	• Fault / alarm
Power supply	• 19,2..30 Vdc	• 19,2..30 Vdc	• 19,2..30 Vdc	• 19,2..30 Vdc	• 19,2..30 Vdc
Isolation	• 1,5 kV (50 Hz, 1 min)	• 1,5 kV (50 Hz, 1 min)	• 1,5 kV (50 Hz, 1 min)	• 1,5 kV (50 Hz, 1 min)	• 1,5 kV (50 Hz, 1 min)
Dimensions	• 93,1 x 6,2 x 102,5 mm	• 93,1 x 6,2 x 102,5 mm	• 93,1 x 6,2 x 102,5 mm	• 93,1 x 6,2 x 102,5 mm	• 93,1 x 6,2 x 102,5 mm
Communication					
Special functions	• Programmable fault and cut-off • Insertable filter	• Programmable fault and cut-off • Insertable filter	• Programmable fault and cut-off • Insertable filter • Settable rejection 50 – 60 Hz	• Square root extraction • Standard tanks linearisation • Signal inversion • Programmable cut-off • Programmable scales on demand	• Square root extraction • Standard tanks linearisation • Signal inversion • Programmable cut-off • Auxiliary power supply on 3 terminal blocks 17..20 V, max current 25 mA

GENERAL DATA

	K109PT	K109PT1000	K109TC	K109UI	K109S
Channels	1 input, 1 output	1 input, 1 output	1 input, 2 outputs	1 input, 1 output	1 input, 1 output
Precision	0,1 %	0,1 %	0,1 %	0,1 %	0,1 %
Thermal drift	< 100 ppm/K	< 120 ppm/K	< 120 ppm/K	< 120 ppm/K	< 120 ppm/K
LED	• Fault / alarm	• Fault / alarm	• Fault / alarm • Threshold setting • Static relay output status	• Fault / alarm	• Fault / alarm
Power supply	• 19,2..30 Vdc	• 19,2..30 Vdc	• 19,2..30 Vdc	• 19,2..30 Vdc	• 19,2..30 Vdc
Isolation	• 1,5 kV (50 Hz, 1 min)	• 1,5 kV (50 Hz, 1 min)	• 1,5 kV (50 Hz, 1 min)	• 1,5 kV (50 Hz, 1 min)	• 1,5 kV (50 Hz, 1 min)
Dimensions	• 93,1 x 6,2 x 102,5 mm	• 93,1 x 6,2 x 102,5 mm	• 93,1 x 6,2 x 102,5 mm	• 93,1 x 6,2 x 102,5 mm	• 93,1 x 6,2 x 102,5 mm
Communication					
Special functions	• Programmable fault and cut-off • Insertable filter	• Programmable fault and cut-off • Insertable filter	• Programmable fault and cut-off • Insertable filter • Settable rejection 50 – 60 Hz	• Square root extraction • Standard tanks linearisation • Signal inversion • Programmable cut-off • Programmable scales on demand	• Square root extraction • Standard tanks linearisation • Signal inversion • Programmable cut-off • Auxiliary power supply on 3 terminal blocks 17..20 V, max current 25 mA

INPUT DATA

Type	PT100	PT1000	THERMOCOUPLE	VOLTAGE	VOLTAGE
PT100	• Pt100 (IEC 751 / EN 60751 – ITS90) • Range: -150..+150 °C • Minimum span: 50 °C • Power on transmitter 900 µA • Connection technique: 2, 3, 4 wires • Max conductor resistance: 20 Ω	• Pt1000 (EN 60751/A2 – ITS90) • Range: -200..+210 °C • Minimum span: 30 °C • Power on transmitter < 350 µA • Connection technique: 2, 3, 4 wires • Max conductor resistance 50 Ω	• Type: J, K, E, N, S, R, B, T (ITS-90 standard) • Temperature range: minimum span 100°C • Impedance: 10 M Ω • Cold junction (semiconductor, ADC 13 bit, precision 1,4 °C, time upgrade 10s)	• Range: 0..10 / 2..10 / 0..5 / 1..5 / 0..15 / 0..30 V reversed • Impedance: 110 k Ω (10 V), 325 k Ω (30 V) • CURRENT • Range: 0..20 / 4..20 mA • Impedance: 35 Ω	• Range: 0..10 / 10..0 / 0..5 / 1..5 V • Impedance: 110 k Ω • CURRENT • Range: 0..20 / 4..20 mA • Impedance: 35 Ω
Absolute value			• Max voltage ± 32 V	• Max voltage: ± 32 V • Current clamp self powered: 400 mΩ	• Max voltage: ± 30 V • Current clamp self powered: 400 mΩ

OUTPUT DATA

Type	VOLTAGE	VOLTAGE	VOLTAGE	VOLTAGE	VOLTAGE
VOLTAGE	• Range: 0..10 / 10..0 / 0..5 / 1..5 V • Max voltage: overrange 10,25 V; fault 10,5 V, available 12 V • Min load resistance: 2 k Ω	• Range: 0..10 / 10..0 / 0..5 / 1..5 V • Max voltage: overrange 10,25 V; fault 10,5 V, available 12 V • Min load resistance: 2 k Ω	• Range: 0..10 / 10..0 / 0..5 / 1..5 V • Min load resistance: 2 k Ω	• Range: 0..10 / 2..10 / 0..5 / 1..5 V • Min load resistance: 2 k Ω	• Range: 0..10 / 2..10 / 0..5 / 1..5 V • Min load resistance: 2 k Ω
CURRENT	• Range: 4..20 / 20..4 / 0..20 / 20..0 mA • Max current: overrange 20,5 mA; fault 21 mA, protection 25 mA • Max load resistance: 500 Ω • Protection: 25 mA	• Range: 4..20 / 20..4 / 0..20 / 20..0 mA • Max current: overrange 20,5 mA; fault 21 mA, protection 25 mA • Max load resistance: 500 Ω • Protection: 25 mA	• Range: 4..20 / 20..4 / 0..20 / 20..0 mA • Max load resistance: 500 Ω	• Range: 4..20 / 20..4 / 0..20 / 20..0 mA • Max load resistance: 500 Ω • Protection: 25 mA	• Range: 4..20 / 20..4 / 0..20 / 20..0 mA • Max load resistance: 500 Ω • Protection: 25 mA
Static relay auxiliary output			• Nominal voltage: 24 Vac/dc • Current: 60 mA • Overvoltage protection: 50 V • Settable alarm threshold / hysteresys		
Response time (10-90%)	< 50 ms (without filter) < 200 ms (with filter)	< 50 ms (without filter) < 200 ms (with filter)	< 40 ms (without filter) < 40/88 ms (with filter)	< 40 ms (without filter) < 40/88 ms (with filter)	< 40 ms (without filter) < 40/88 ms (with filter)
D/A conversion Resolution	1 mV, 2 µA	1 mV, 2 µA	1 mV, 2 µA	1 mV, 2 µA	1 mV, 2 µA

	K109SH	K107A	K107B	K107USB	K-SUPPLY
Channels	1 input, 1 output	1 input, 1 output	1 input, 1 output	1 input, 1 output	2 inputs, 1 output
Precision	0,1 %				
Thermal drift	< 120 ppm/K				
LED	• Fault / alarm	• Power ON • Data OK • Inverted connection	• Power ON • Data OK • Inverted connection	• Power ON • RS485 Rx • RS485 Tx	• Input 1 switch on threshold • Input 1 switch on threshold • Alternate / inverted polarity of inputs
Power supply	• 19,2..30 Vdc	• 19,2..30 Vdc	• 19,2..30 Vdc	• By USB port of the PC	
Isolation	• 1,5 kV (50 Hz, 1 min)	• 1,5 kV (50 Hz, 1 min)	• 1,5 kV (50 Hz, 1 min)	• 1.500 V (USB / RS485)	
Dimensions	• 93,1 x 6,2 x 102,5 mm	• 93,1 x 6,2 x 102,5 mm	• 93,1 x 6,2 x 102,5 mm	• 93,1 x 6,2 x 102,5 mm	• 93,1 x 6,2 x 102,5 mm
Communication		• RS485 serial repeater, 3 ways isolation, automatic flow control.	• RS232B / RS485 serial converter, half duplex, 3 ways isolation, automatic flow control.	• RS485/USB asynchronous serial converter with specific drivers. Isolated RS485 / USB interface.	• Redundant power supply module with overvoltages protection and differential mode filter.
Special functions				• Compliance to USB 1.1 and 2.0 • Plug&play for WIN 98, 2000 and XP • Multiple connection on the same PC • CD Driver	• Differential mode filter • Integrated protection against overvoltages • Connection with redundant power supply, to several bus and parallel inputs

	K109SH	K107A	K107B	K107USB	K-SUPPLY
Channels	1 input, 1 output	1 input, 1 output	1 input, 1 output	1 input, 1 output	2 inputs, 1 output
Precision	0,1 %				
Thermal drift	< 120 ppm/K				
LED	• Fault / alarm	• Power ON • Data OK • Inverted connection	• Power ON • Data OK • Inverted connection	• Power ON • RS485 Rx • RS485 Tx	• Input 1 switch on threshold • Input 1 switch on threshold • Alternate / inverted polarity of inputs
Power supply	• 19,2..30 Vdc	• 19,2..30 Vdc	• 19,2..30 Vdc	• By USB port of the PC	
Isolation	• 1,5 kV (50 Hz, 1 min)	• 1,5 kV (50 Hz, 1 min)	• 1,5 kV (50 Hz, 1 min)	• 1.500 V (USB / RS485)	
Dimensions	• 93,1 x 6,2 x 102,5 mm	• 93,1 x 6,2 x 102,5 mm	• 93,1 x 6,2 x 102,5 mm	• 93,1 x 6,2 x 102,5 mm	• 93,1 x 6,2 x 102,5 mm
Communication		• RS485 serial repeater, 3 ways isolation, automatic flow control.	• RS232B / RS485 serial converter, half duplex, 3 ways isolation, automatic flow control.	• RS485/USB asynchronous serial converter with specific drivers. Isolated RS485 / USB interface.	• Redundant power supply module with overvoltages protection and differential mode filter.
Special functions				• Compliance to USB 1.1 and 2.0 • Plug&play for WIN 98, 2000 and XP • Multiple connection on the same PC • CD Driver	• Differential mode filter • Integrated protection against overvoltages • Connection with redundant power supply, to several bus and parallel inputs

	K109SH	K107A	K107B	K107USB	K-SUPPLY
VOLTAGE	• Shunt: from ±100 mV up to ± 500 mV				
SERIAL		• Half duplex (31 nodes, terminal, protection up to 30 Vdc)			
SERIAL			• RS232B, protection up to 30 Vdc		
SERIAL				• USB interface, USB standard 1.0 / 2.0 compliance, USB A and MINI USB B connectors	
POWER SUPPLY					• 2 inputs with shared negative terminal • Pass-through each input can be accessed by 2 pairs of terminals • Max current per terminal: 4 A • Positive inputs protected by an external fuse of recommended sizing

	K109SH	K107A	K107B	K107USB	K-SUPPLY
TENSIONE	• Range: 0..10 / 2..10 / 0..5 / 1..5 V • Min load resistance: 2 k Ω				
SERIAL		• RS485 Half duplex (31 nodes, terminal, protection up to 30 Vdc)			
SERIAL			• RS485 Half duplex (31 nodes, terminal, protection up to 30 Vdc)		
SERIAL				• RS 485, max 31 nodes, spring-cage terminal block	
POWER SUPPLY					• Max voltage drop: 300 mV
CURRENT	• Range: 4..20 / 20..4 / 0..20 / 20..0 mA • Max load resistance: 500 Ω • Protection: 25 mA				

GENERAL INFORMATIONS

Power supply range*	19,2.. 30 Vdc
Bridge voltage supply	Bus connectors (K-BUS) can be snapped onto 35 mm DIN guide rail according to EN 60175
Wire section	0,2..2,5 mm ²
Wire stripping	8 mm
Power on side terminals	Yes
Hot swapping	Yes
Max current consumption	21..25 mA (24 Vdc)
Consumption without load at 25°C	7,5 mA
Max power consumption	500 mOhm
A/D conversion	14 bit
Rejection	50 o 60 Hz (programmable)
Settings	DIP Switch
Filter	Insertable
Dimensions	93,1 x 6,2 x 102,5 mm
Isolation	1,5 kV (50 Hz, 1 min)
Isolation technique	Digital (optocoupler)
Processing	Floating point 32 bit
Colour	Black
Case material	PBT
Weight	45 g
Operating temperature	-20..+65 °C
Storage temperature	-40..+85 °C
Humidity	10..90 % non condensing
Connection	Clamp terminals and/or bus
Protection degree	IP 20
Conformity	CE, EN 50081-2, EN 50082-2, EN 61010-1, EN 60742

* Except for K107USB and K-SUPPLY

CONNECTION AND INSTALLING

CAGE CLAMP CONNECTION

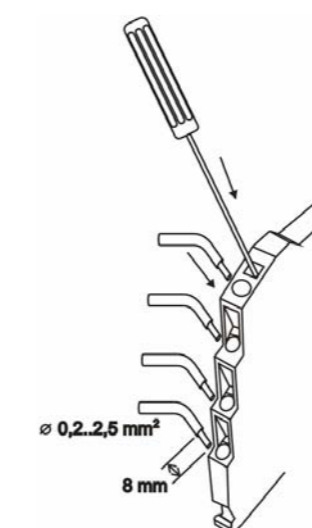

Instruction sequence requires stripping of cables, opening block spring with a screwdriver, inserting the cable in the hole.

K-BUS

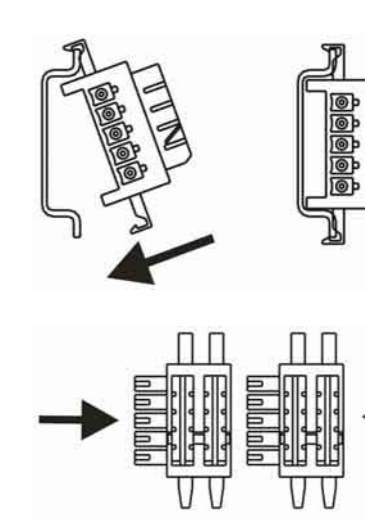

Each expandable connector K-BUS allows inserting two modules. K-BUS are inserted on guide setting them to the top and round them at the bottom.

INSERTING MODULE ON DIN GUIDE

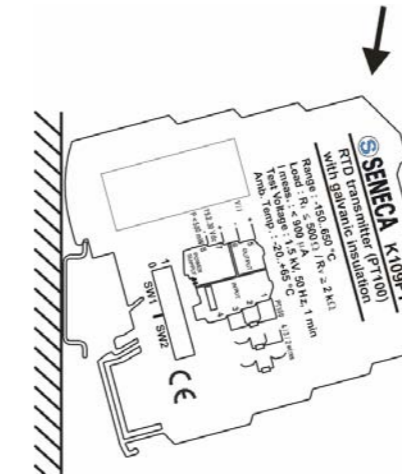

Module is screw hold on the top of DIN guide, then it has to be pressed to the bottom for the final clip-on fastening.

EXTRACTING MODULE ON DIN GUIDE

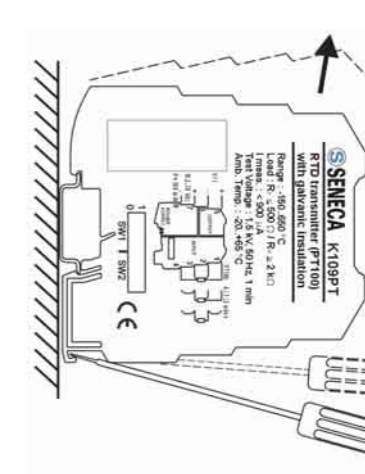

Pry downward on the latch with a screwdriver, then round the module to the top.