

Low voltage current transformers for industrial applications

Plug-in current transformers

ASK 205.3	Primary conductor Round conductor Transformer width		20 x 5 mm \varnothing 17.5 mm 49.5 mm
ASK 21.3	Primary conductor Round conductor Transformer width		20 x 10 mm \varnothing 19.2 mm 61 mm
ASK 231.5	Primary conductor Round conductor Transformer width		30 x 10 mm \varnothing 28 mm 50 mm
ASK 31.3 ASK 31.3 2U	Primary conductor Round conductor Transformer width		30 x 10 mm 2 x 20 x 10 mm \varnothing 26 mm 61 mm
ASK 318.3	Primary conductor Round conductor Transformer width		31 x 18 mm \varnothing 26 mm 61 mm
ASK 31.4 ASK 31.4 2U ASK 31.4 3U	Primary conductor Round conductor Transformer width		30 x 10 mm 2 x 20 x 10 mm \varnothing 28 mm 61 mm
ASK 31.5 ASK 31.5 2U	Primary conductor Round conductor Transformer width		30 x 10 mm 2 x 20 x 10 mm \varnothing 28 mm 61 mm
ASK 31.6	Primary conductor Round conductor Transformer width		30 x 10 mm 20 x 13 mm \varnothing 23 mm 95 mm



ASK 205.3

Plug-in current transformer

Secondary current		5A	1A
Primary current A	Burden VA	Accuracy class	Accuracy class
		1	1
		Art.-no.	Art.-no.
60	1	2019	2219
75	1	2020	2220
80	1.25	2021	2221
100	1.25	2022	2222
	1.5	2023	2223
150	1.5	2024	2224
	2.5	2025	2225
200	1.5	2026	2226
	2.5	2027	2227
250	2.5	2028	2228
	5	2029	2229
300	2.5	2030	2230
	5	2031	2231
400	2.5	2032	2232
	5	2033	2233
	10	2034	2234

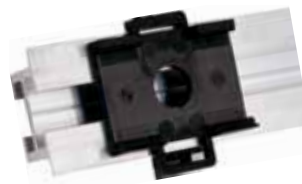
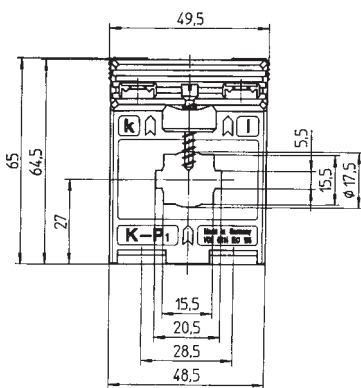
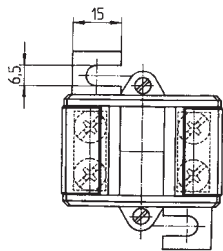
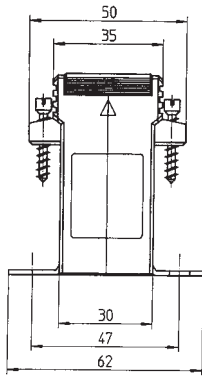

Snap-on mounting

Primary conductor	20 x 5 mm
Round conductor	Ø 17.5 mm
Transformer width	49.5 mm
Snap-on mounting	Art.-no. 55014 see page 204
Sealed shutter	—

ASK 21.3

Plug-in current transformer

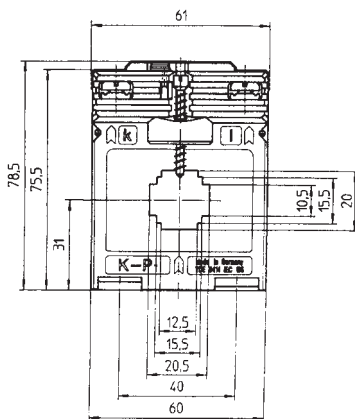
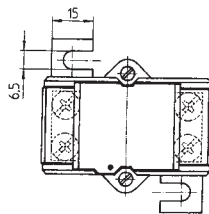
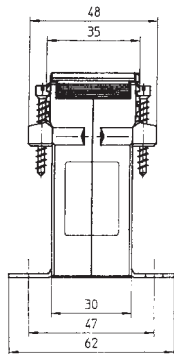

Secondary current		5A			1A	
Primary current A	Burden VA	Accuracy class			Accuracy class	
		1	0.5	0.2s	1	0.5
		Art.-no.	Art.-no.	Art.-no.	Art.-no.	Art.-no.
40	1	6034			6234	
50	1	6035			6235	
	1.5	6036			6236	
60	1	6037			6237	
	1.5	6038			6238	
75	1.5	6039			6239	
	2.5	6040			6240	
80	1.5	6041			6241	
	2.5	6042			6242	
100	1.5	6043	6011		6243	6211
	2.5	6044	6111		6244	6311
	5	6045			6245	
150	1.5	6046	6012	V10-1604C	6246	6212
	2.5	6047	6013	V10-1604D	6247	6213
	5	6048	6074		6248	6274
200	1.5		6014			6214
	2.5	6049	6015	V10-1704D	6249	6215
	5	6050	6016	V10-1704F	6250	6216
	10	6051			6251	
250	1.5		6017			6217
	2.5	6052	6018	V10-1804D	6252	6218
	5	6053	6019	V10-1804F	6253	6219
	10	6054	6020		6254	6220
	15	6055			6255	
300	2.5	6056	6022	V10-1904D	6256	6222
	5	6057	6023	V10-1904F	6257	6223
	10	6058	6024		6258	6224
	15	6059			6259	
400	2.5	6060	6025	V10-2004D	6260	6225
	5	6061	6026	V10-2004F	6261	6226
	10	6062	6027		6262	6227
	15	6063			6263	
500	2.5	6064	6028	V10-2104D	6264	6228
	5	6065	6029	V10-2104F	6265	6229
	10	6066	6030		6266	6230
	15	6067			6267	
600	2.5	6068	6031		6268	6231
	5	6069	6032		6269	6232
	10	6070	6033		6270	6233
	15	6071			6271	

Primary conductor	20 x 10 mm
Round conductor	Ø 19.2 mm
Transformer width	61 mm
Snap-on mounting	Art.-no. 53011 see page 204
Sealed shutter	Art.-no. 59040 see page 205
Protection plug-in current transformer	see page 126
Current transformer for tariff applications	see page 168

ASK 231.5

Plug-in current transformer

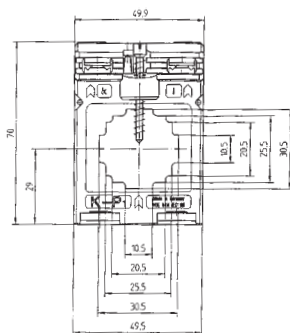
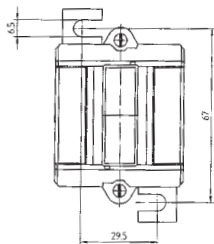
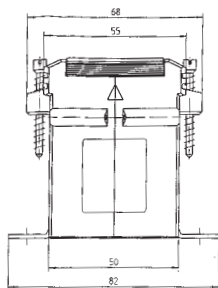

Secondary current		5A		1A	
Primary current A	Burden VA	Accuracy class		Accuracy class	
		1	0,5	1	0,5
		Art.-no.	Art.-no.	Art.-no.	Art.-no.
50	1	92050		92250	
	1,25	92051		92251	
60	1	92052		92252	
	1,25	92053		92253	
75	1,25	92054		92254	
	2,5	92055		92255	
80	1,25	92056		92256	
100	1,5	92059		92259	
	2,5	92060			
125	1,5	92062	92020	92262	92220
	2,5	92063		92263	
150	1,5	92065	92023	92265	92223
	2,5	92066		92266	
200	2,5	92068	92026	92268	92226
	5	92069		92269	
250	2,5	92071	92028	92271	92228
	5	92072	92029	92272	92229
300	2,5	92074	92030	92274	92230
	5	92075		92275	
400	2,5	92077	92032	92277	92232
	5	92078	92033	92278	92233
	10			92279	
500	2,5	92081	92035	92281	92235
	5	92082	92036	92282	92236
	10	92083		92283	
600	2,5	92085	92038		
	5	92086	92039		
	10	92087			

Primary conductor	30 x 10 mm
Round conductor	Ø 28.0 mm
Transformer width	50 mm
Snap-on mounting	—
Sealed shutter	—



ASK 31.3

Plug-in current transformer

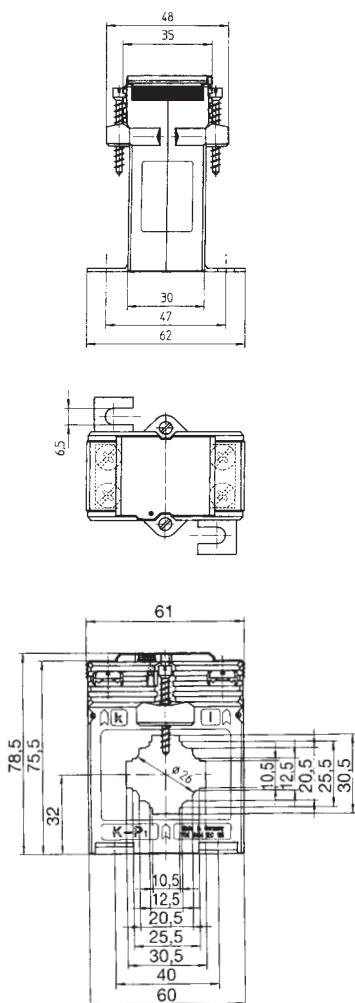

Secondary current		5A			1A	
Primary current A	Burden VA	Accuracy class			Accuracy class	
		1	0,5	0,2s	1	0,5
		Art.-no.	Art.-no.	Art.-no.	Art.-no.	Art.-no.
50	1	7038			7238	
60	1	7039			7239	
75	1	7040			7240	
	1.5	7041			7241	
80	1.5	7042			7242	
	2.5	7043			7243	
	5	7044	7011		7244	7211
100	1.5	7044	7011		7244	7211
	2.5	7045	7012		7245	7212
150	1.5	7046	7013	V11-1604C	7246	7213
	2.5	7047	7014		7247	7214
200	1.5	7048	7015		7248	7215
	2.5	7049	7016	V11-1704D	7249	7216
	5	7050	7017		7250	7217
250	1.5	7051	7018		7251	7218
	2.5	7052	7019	V11-1804D	7252	7219
	5	7053	7020	V11-1804F	7253	7220
	10	7054			7254	
300	1.5	7055	7021		7255	7221
	2.5	7056	7022	V11-1904D	7256	7222
	5	7057	7023	V11-1904F	7257	7223
	10	7058			7258	7224
400	1.5	7059			7259	
	2.5	7060	7025	V11-2004D	7260	7225
	5	7061	7026	V11-2004F	7261	7226
	10	7062	7027		7262	7227
500	2.5	7063	7028	V11-2104D	7263	7228
	5	7064	7029	V11-2104F	7264	7229
	10	7065	7030		7265	7230
600	2.5	7066	7031	V11-2204D	7266	7231
	5	7067	7032	V11-2204F	7267	7232
	10	7068	7033		7268	7233
	15	7069	7034		7269	7234
750	2.5	7070	7035	V11-2304D	7270	7235
	5	7071	7036	V11-2304F	7271	7236
	10	7072	7037		7272	7237

ASK 31.3 2U

Primary conductor	30 x 10 mm 2 x 20 x 10 mm
Round conductor	Ø 26 mm
Transformer width	61 mm
Snap-on mounting	Art.-no. 53011 see page 204
Sealed shutter	Art.-no. 59040 see page 205
Current transformer for tariff applications	see page 169

Secondary current		5A	1A
Primary current A	Burden VA	Accuracy class	Accuracy class
		1	1
		Art.-no.	Art.-no.
200-100	5-2.5	7111	7311
300-150	5-2.5	7112	7312
400-200	5-2.5	7113	7313
	10-5	7114	7314
500-250	5-2.5	7115	7315
	10-5	7116	7316
600-300	10-5	7117	7317
	15-7.5	7118	7318

ASK 318.3

Plug-in current transformer

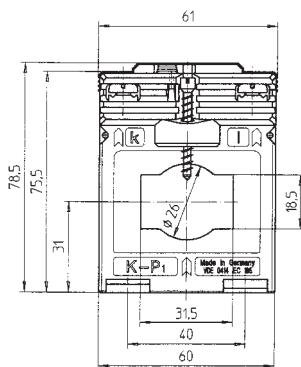
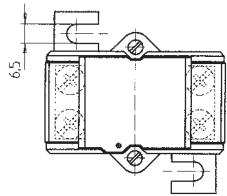
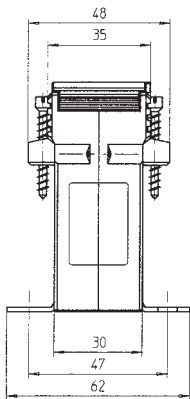

Secondary current		5A		1A	
Primary current A	Burden VA	Accuracy class		Accuracy class	
		1	0.5	1	0.5
		Art.-no.	Art.-no.	Art.-no.	Art.-no.
60	1	29042		29242	
75	1	29043		29243	
	1.5	29044		29244	
80	1.5	29045		29245	
	2.5	29046		29246	
100	1.5	29047	29011	29247	29211
	2.5	29048	29012	29248	29212
150	1.5	29049	29013	29249	29213
	2.5	29050	29014	29250	29214
200	2.5	29052	29016	29252	29216
	5	29053	29017	29253	29217
250	2.5	29055	29019	29255	29219
	5	29056	29020	29256	29220
	10	29057		29257	
300	2.5	29059	29023	29259	29223
	5	29060	29024	29260	29224
	10	29061		29261	
400	2.5	29063	29027	29263	29227
	5	29064	29028	29264	29228
	10	29065	29029	29265	29229
500	2.5	29066	29030	29266	29230
	5	29067	29031	29267	29231
	10	29068	29032	29268	29232
600	2.5	29069	29033	29269	29233
	5	29070	29034	29270	29234
	10	29071	29035	29271	29235
	15	29072	29036	29272	29236
750	2.5	29073	29037	29273	29237
	5	29074	29038	29274	29238
	10	29075	29039	29275	29239
	15	29076	29040	29276	29240



Snap-on mounting

Primary conductor	31 x 18 mm
Round conductor	Ø 26.0 mm
Transformer width	61 mm
Snap-on mounting	Art.-no. 53011 see page 204
Sealed shutter	Art.-no. 59040 see page 205

ASK 31.4

Plug-in current transformer

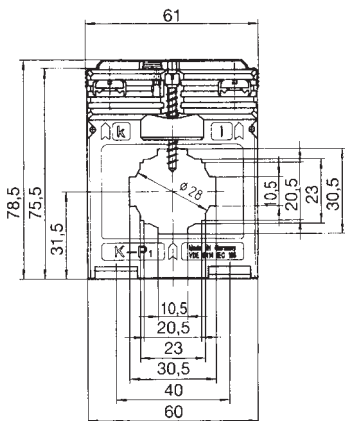
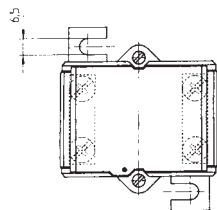
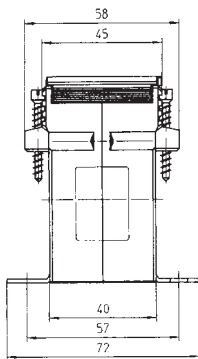

Primary conductor	30 x 10 mm 2 x 20 x 10 mm
Round conductor	Ø 28 mm
Transformer width	61 mm
Snap-on mounting	Art.-no. 54011 see page 204
Sealed shutter	Art.-no. 59041 see page 205
Current transformer for tariff applications	see page 170

Secondary current		5A			1A	
Primary current A	Burden VA	Accuracy class			Accuracy class	
		1	0.5	0.2s	1	0.5
		Art.-no.	Art.-no.	Art.-no.	Art.-no.	Art.-no.
50	1.25	8157			8357	
	1.5	8038			8238	
60	1.25	8158			8358	
	1.5	8039			8239	
75	1.5	8041			8241	
	2.5	8042			8242	
80	1.5	8043			8243	
	2.5	8044			8244	
100	1.5	8045	8011		8245	8211
	2.5	8046	8010		8246	8210
	3.75	8152			8276	
	5	8047			8247	
150	1.5	8048	8012	V14-1604C	8248	8212
	2.5	8049	8013	V14-1604D	8249	8213
	5	8050	8410		8250	
	7.5	8051			8251	
200	2.5	8052	8014	V14-1704D	8252	8214
	5	8053	8015	V14-1704F	8253	8215
	10	8054			8254	
250	2.5	8055	8016	V14-1804D	8255	8216
	5	8056	8017	V14-1804F	8256	8217
	10	8057			8257	
	15	8058			8258	
300	2.5	8059	8018	V14-1904D	8259	8218
	5	8060	8019	V14-1904F	8260	8219
	10	8061	8020		8261	8220
	15	8062			8262	
400	2.5	8063	8021	V14-2004D	8263	8221
	5	8064	8022	V14-2004F	8264	8222
	10	8065	8023		8265	8223
	15	8066			8266	8224
500	2.5	8067	8025	V14-2104D	8267	8225
	5	8068	8026	V14-2104F	8268	8226
	10	8069	8027		8269	8227
	15	8070			8270	8228
600	2.5	8071	8029	V14-2204D	8271	8229
	5	8072	8030	V14-2204F	8272	8230
	10	8073	8031	V14-2204H	8273	8231
	15	8074	8032		8274	8232
750	2.5	8153	8033	V14-2304D	8353	8233
	5	8154	8034	V14-2304F	8354	8234
	10	8155	8035	V14-2304H	8355	8235
	15	8156	8036		8356	8236

Change-over transformers see page 48.



ASK 31.4 2U

Plug-in current transformer

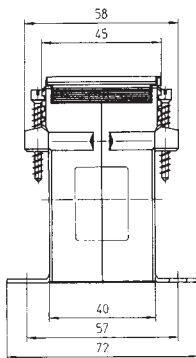

Secondary current		5A	1A
Primary current A	Burden VA	Accuracy class	Accuracy class
		1	1
		Art.-no.	Art.-no.
200-100	5-2.5	8117	8317
	10-5	8118	8318
300-150	5-2.5	8119	8319
	10-5	8120	8320
400-200	5-2.5	8121	8321
	10-5	8122	8322
500-250	5-2.5	8123	8323
	10-5	8124	8324
600-300	5-2.5	8125	8325
	15-7.5	8126	8326

ASK 31.4 3U

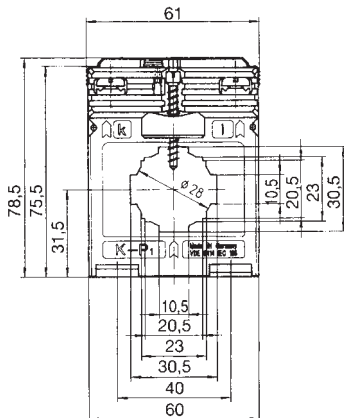
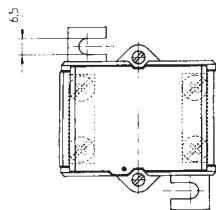

Secondary current		5A	1A
Primary current A	Burden VA	Accuracy class	Accuracy class
		1	1
		Art.-no.	Art.-no.
300-200-100	10-5-2.5	8137	8337
400-200-100	10-5-2.5	8138	8338
600-300-150	10-5-2.5	8139	8339
	15-10-5	8140	8340
600-400-200	10-5-2.5	8141	8341
	15-10-5	8142	8342

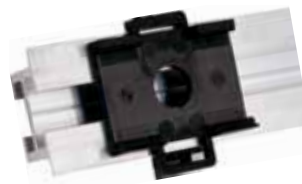

Snap-on mounting

Primary conductor	30 x 10 mm 2 x 20 x 10 mm
Round conductor	Ø 28 mm
Transformer width	61 mm
Snap-on mounting	Art.-no. 54011 see page 204
Sealed shutter	Art.-no. 59041 see page 205
Current transformer for tariff applications	see page 170



ASK 31.5

Plug-in current transformer

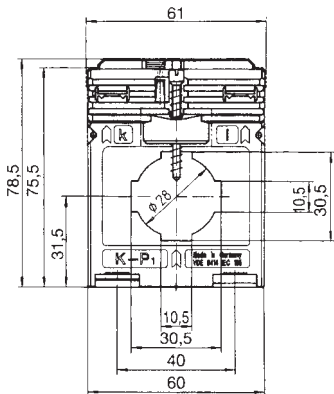
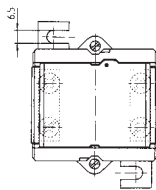
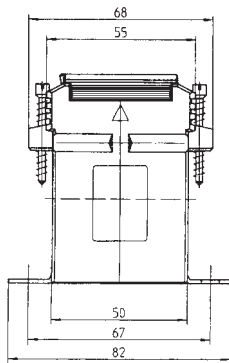

Primary conductor	30 x 10 mm 2 x 20 x 10 mm
Round conductor	Ø 28 mm
Transformer width	61 mm
Snap-on mounting	Art.-no. 55011 see page 204
Sealed shutter	Art.-no. 59041 see page 205
Protection plug-in current transformer	see page 127
Current transformer for tariff applications	see page 171

Secondary current	Burden VA	5A		1A	
		Accuracy class		Accuracy class	
		1	0.5	1	0.5
Primary current A		Art.-no.	Art.-no.	Art.-no.	Art.-no.
40	1	9043		9243	
50	1.5	9045		9245	
	2.5	9046		9246	
60	1.5	9047		9247	
	2.5	9048		9248	
75	1.5	9049	9011	9249	9211
	2.5	9050	9012	9250	9212
80	1.5	9051	9013	9251	9213
	2.5	9052	9014	9252	9214
	5	9053		9253	
100	1.5	9054	9015	9254	9215
	2.5	9055	9016	9255	9216
	5	9056	9017	9256	9217
150	2.5	9057	9018	9257	9218
	5	9058	9019	9258	9219
	7.5	9059		9259	
200	2.5	9060	9020	9260	9220
	5	9061	9021	9261	9221
	10	9062	9022	9262	9222
	15	9063		9263	
250	5	9064	9023	9264	9223
	10	9065	9024	9265	9224
	15	9066	9025	9266	9225
300	5	9067	9026	9267	9226
	10	9068	9027	9268	9227
	15	9069	9028	9269	9228
400	5	9070	9029	9270	9229
	10	9071	9030	9271	9230
	15	9072	9031	9272	9231
	30	9073		9273	
500	5	9074	9032	9274	9232
	10	9075	9033	9275	9233
	15	9076	9034	9276	9234
	30	9077		9277	
600	5	9078	9035	9278	9235
	10	9079	9036	9279	9236
	15	9080	9037	9280	9237
	30	9081		9281	
750	5	9082	9038	9282	9238
	10	9083	9039	9283	9239
	15	9084	9040	9284	9240
	30	9085		9285	

Change-over transformers see page 50.



ASK 31.5 2U

Plug-in current transformer

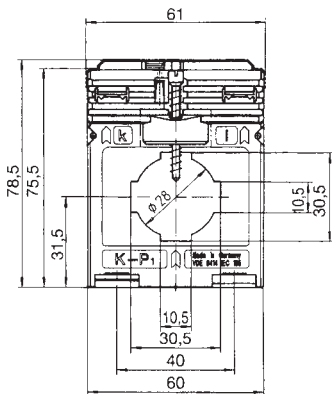
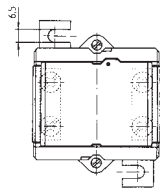
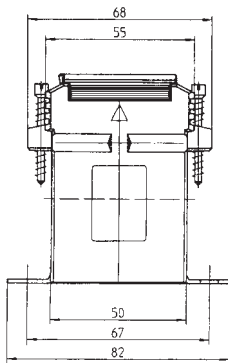

Secondary current		5A	1A
Primary current A	Burden VA	Accuracy class	Accuracy class
		1	1
		Art.-no.	Art.-no.
150-75	5-2.5	9132	9332
	10-5	9133	9333
	15-7.5	9134	9334
200-100	5-2.5	9135	9335
	10-5	9136	9336
	15-7.5	9137	9337
300-150	5-2.5	9138	9338
	10-5	9139	9339
	15-7.5	9140	9340
400-200	5-2.5	9141	9341
	10-5	9142	9342
	15-7.5	9143	9343
500-250	5-2.5	9144	9344
	10-5	9145	9345
	15-7.5	9146	9346
600-300	5-2.5	9144	9344
	10-5	9145	9345
	15-7.5	9146	9346

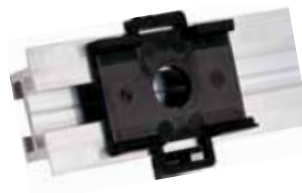

Snap-on mounting

Primary conductor	30 x 10 mm 2 x 20 x 10 mm
Round conductor	Ø 28 mm
Transformer width	61 mm
Snap-on mounting	Art.-no. 55011 see page 204
Sealed shutter	Art.-no. 59041 see page 205
Protection plug-in current transformer	see page 127
Current transformer for tariff applications	see page 171



ASK 31.6

Plug-in current transformer

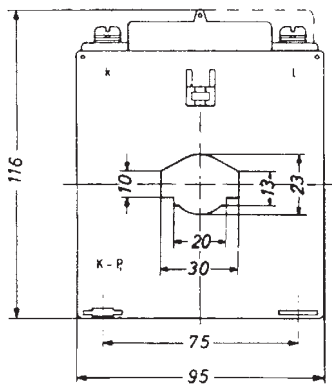
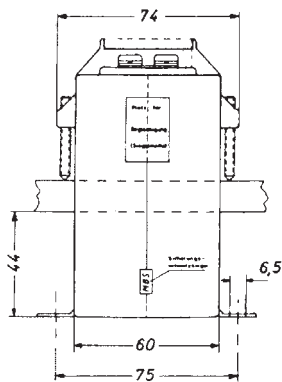

Secondary current		5A		1A	
Primary current A	Burden VA	Accuracy class		Accuracy class	
		1	0.5	1	0.5
		Art.-no.	Art.-no.	Art.-no.	Art.-no.
30	1.5	10054		10254	
40	1.5	10056		10256	
	2.5	10057		10257	
50	1.5		10011		10211
	2.5	10058	10012	10258	10212
60	1.5		10013		10213
	2.5	10059	10014	10259	10214
	5	10060		10260	
75	2.5	10061	10015	10261	10215
	5	10062	10016	10262	10216
80	2.5	10063	10017	10263	10217
	5	10064	10018	10264	10218
	10	10065		10265	
100	2.5	10066	10019	10266	10219
	5	10067	10020	10267	10220
	10	10068	10021	10268	10221
	15	10069		10269	
150	2.5		10022		10222
	5	10070	10023	10270	10223
	10	10071	10024	10271	10224
	15	10072	10025	10272	10225
200	2.5		10026		10226
	5	10073	10027	10273	10227
	10	10074	10028	10274	10228
	15	10075	10029	10275	10229
250	5	10076	10030	10276	10230
	10	10077	10031	10277	10231
	15	10078	10032	10278	10232
300	5	10079	10034	10279	10234
	10	10080	10035	10280	10235
	15	10081	10036	10281	10236
400	5	10082	10038	10282	10238
	10	10083	10039	10283	10239
	15	10084	10040	10284	10240
500	5	10085	10042	10285	10242
	10	10086	10043	10286	10243
	15	10087	10044	10287	10244
600	5	10088	10046	10288	10246
	10	10089	10047	10289	10247
	15	10090	10048	10290	10248
750	5	10091	10050	10291	10250
	10	10092	10051	10292	10251
	15	10093	10052	10293	10252

Primary conductor	30 x 10 mm 20 x 13 mm
Round conductor	Ø 23 mm
Transformer width	95 mm
Snap-on mounting	—
Sealed shutter	Art.-no. 59044 see page 205
Protection plug-in current transformer	see page 128
Current transformer for tariff applications	see page 172

Plug-in current transformers

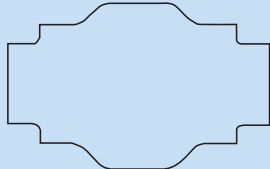
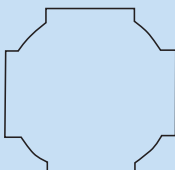
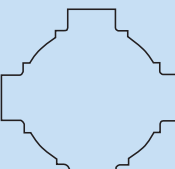
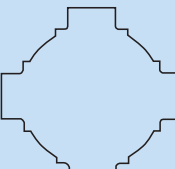
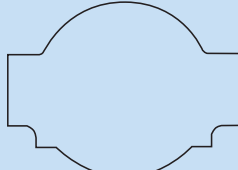
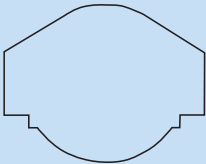
ASK 41.3	Primary conductor		40 x 12 mm
	Round conductor Transformer width		32 x 18 mm Ø 26 mm 61 mm
ASK 421.4	Primary conductor		20 x 10 mm
	Round conductor Transformer width		Ø 20 mm 71 mm
ASK 41.4 ASK 41.4 2U ASK 41.4 3U	Primary conductor		40 x 10 mm
	Round conductor		2 x 30 x 5 mm Ø 32 mm
	Transformer width		71 mm
ASK 41.5	Primary conductor		40 x 10 mm
	Round conductor		Ø 32 mm
	Transformer width		71 mm
ASK 412.4 ASK 412.4 2U ASK 412.4 3U	Primary conductor		40 x 12 mm
	Round conductor		30 x 15 mm Ø 30.5 mm
	Transformer width		71 mm
ASK 41.6	Primary conductor		40 x 12 mm
	Round conductor Transformer width		30 x 15 mm Ø 32 mm 95 mm

ASK 41.3

Plug-in current transformer

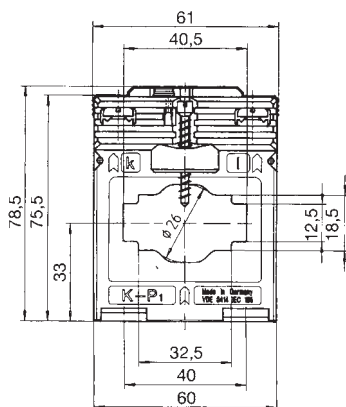
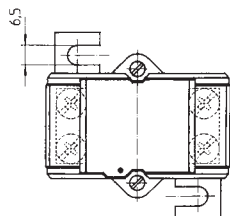
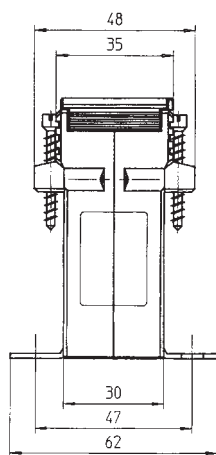

Secondary current		5A	1A
Primary current A	Burden VA	Accuracy class	Accuracy class
		1	1
		Art.-no.	Art.-no.
100	1	11037	11237
	1.5	11038	11238
150	1.5	11039	11239
	2.5	11040	11240
200	1.5	11041	11241
	2.5	11042	11242
250	1.5	11043	11243
	2.5	11044	11244
	5	11045	11245
300	1.5	11046	11246
	2.5	11047	11247
	5	11048	11248
400	1.5	11049	
	2.5	11050	
	5	11051	
500	1.5	11052	
	2.5	11053	
	5	11054	
	10	11055	
600	1.5	11056	
	2.5	11057	
	5	11058	
	10	11059	
750	2.5	11060	
	5	11061	
	10	11062	
800	15	11063	
	2.5	11064	
	5	11065	
	10	11066	
	15	11067	

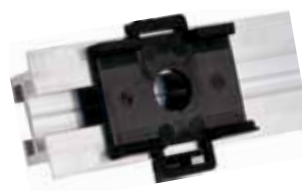

Snap-on mounting

Primary conductor	40 x 12 mm 32 x 18 mm
Round conductor	Ø 26.0 mm
Transformer width	61 mm
Snap-on mounting	Art.-no. 53011 see page 204
Sealed shutter	Art.-no. 59040 see page 205



ASK 421.4

Plug-in current transformer

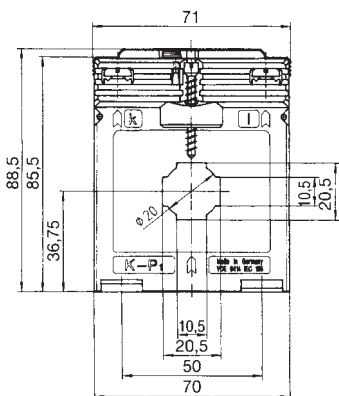
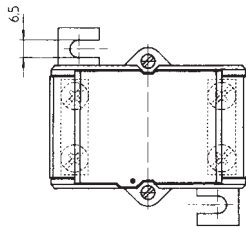
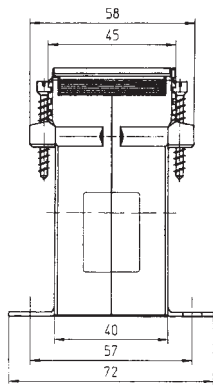

Secondary current		5A		1A	
Primary current A	Burden VA	Accuracy class		Accuracy class	
		1	0.5	1	0.5
		Art.-no.	Art.-no.	Art.-no.	Art.-no.
30	1	12033		12233	
40	1.5	12034		12234	
50	1.5	12035	12011	12235	12211
	2.5	12036		12236	
60	1.5	12037	12012	12237	12212
	2.5	12038		12238	
	3.75			12239	
	5	12039			
75	2.5	12040	12013	12240	12213
	5	12041		12241	
80	2.5	12042	12014	12242	12214
	5	12043		12243	
100	2.5	12044	12015	12244	12215
	5	12045	12016	12245	12216
	10	12046		12246	
125	2.5	12047	12017	12247	12217
	5	12048	12018	12248	12218
	10	12049		12249	
150	2.5		12019		12219
	5	12050	12020	12250	12220
	10	12051		12251	
200	2.5		12021		12221
	5	12053	12022	12253	12222
	10	12054		12254	
	15	12055		12255	
250	5	12056	12023	12256	12223
	10	12057	12024	12257	12224
	15	12058		12258	
300	5	12059	12025	12259	12225
	10	12060	12026	12260	12226
	15	12061		12261	
400	5		12027		12227
	10	12062	12028	12262	12228
	15	12063	12029	12263	12229
	30	12064		12264	
500	5		12030		12230
	10	12065	12031	12265	12231
	15	12066	12032	12266	12232
	30	12067		12267	

Primary conductor	20 x 10 mm
Round conductor	Ø 20 mm
Transformer width	71 mm
Snap-on mounting	—
Sealed shutter	Art.-no. 59041 see page 205
Protection plug-in current transformers	see page 132

ASK 41.4

Plug-in current transformer

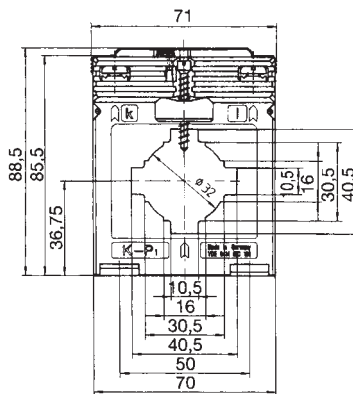
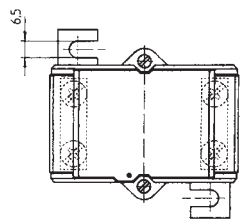
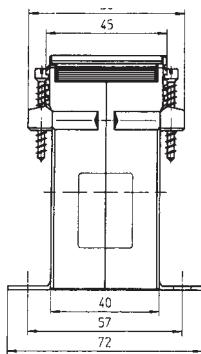

Primary conductor	40 x 10 mm 2 x 30 x 5 mm
Round conductor	Ø 32 mm
Transformer width	71 mm
Snap-on mounting	Art.-no. 55012 see page 204
Sealed shutter	Art.-no. 59041 see page 205
Protection plug-in current transformer	see page 133
Current transformer for tariff applications	see page 174

Secondary current		5A			1A	
Primary current A	Burden VA	Accuracy class			Accuracy class	
		1	0.5	0.2s	1	0.5
		Art.-no.	Art.-no.	Art.-no.	Art.-no.	Art.-no.
50	1.25	13180			13380	
	1.5	13036			13236	
60	1.25	13181			13238	
	1.5	13037			13237	
75	1.5	13039			13239	
	2.5	13040			13240	
80	1.5	13041			13241	
	2.5	13042			13242	
100	1.5	13043	13011		13243	13211
	2.5	13044	13083		13244	13283
	3.75	13179			13245	
150	1.5	13046	13012	V24-1604C	13246	13212
	2.5	13047	13013	V24-1604D	13247	13213
	5	13048	13084		13248	13284
200	1.5		13014	V24-1704C		13214
	2.5	13049	13015	V24-1704D	13249	13215
	5	13050	13085	V24-1704F	13250	13285
	10	13051			13251	
250	1.5		13016			13216
	2.5	13052	13017	V24-1804D	13252	13217
	5	13053	13086	V24-1804F	13253	13286
	10	13054			13254	
300	2.5	13055	13018	V24-1904D	13255	13218
	5	13056	13019	V24-1904F	13256	13219
	10	13057	13087		13257	13287
	15	13058			13258	
400	2.5	13059	13020	V24-2004D	13259	13220
	5	13060	13021	V24-2004F	13260	13221
	10	13061	13088	V24-2004H	13261	13288
	15	13062			13262	
500	2.5	13063	13022	V24-2104D	13263	13222
	5	13064	13023	V24-2104F	13264	13223
	10	13065	13024	V24-2104H	13265	13224
	15	13066	13089		13266	13289
600	2.5	13067	13025	V24-2204D	13267	13225
	5	13068	13026	V24-2204F	13268	13226
	10	13069	13027		13269	13227
	15	13070	13090		13270	13290
750	2.5			V24-2304D		
	5	13071	13028	V24-2304F	13271	13228
	10	13072	13029	V24-2304H	13272	13229
800	15	13073	13091		13273	13291
	5	13075	13030		13275	13230
	10	13076	13031		13276	13231
1000	15	13077			13277	
	30	13078			13278	
	5	13079	13032		13279	13232
	10	13080	13033		13280	13233
	15	13081	13034		13281	13234
	30	13082			13282	



ASK 41.4 2U

Plug-in current transformer

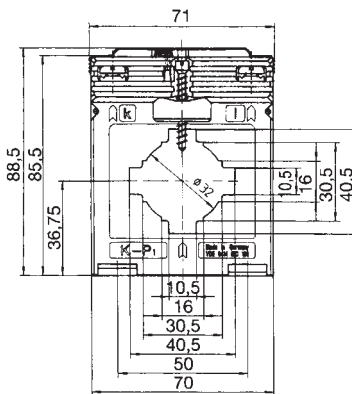
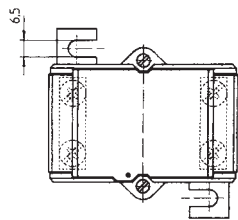
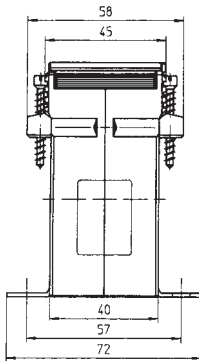

Secondary current		5A	1A
Primary current A	Burden VA	Accuracy class	Accuracy class
		1	1
		Art.-no.	Art.-no.
200-100	5-2.5	13133	13333
	10-5	13134	13334
300-150	5-2.5	13135	13335
	10-5	13136	13336
400-200	5-2.5	13137	13337
	10-5	13138	13338
500-250	5-2.5	13139	13339
	10-5	13140	13340
600-300	5-2.5	13141	13341
	10-5	13177	13342
800-400	5	13142	13343
	5-2.5	13143	13344
	10-5	13144	13345
	15-7.5	13145	13346
1000-500	5-2.5	13146	13347
	10-5	13147	
	15-7.5		

ASK 41.4 3U

Secondary current		5A	1A
Primary current A	Burden VA	Accuracy class	Accuracy class
		1	1
		Art.-no.	Art.-no.
400-200-100	10-5-2.5	13163	13363
600-300-150	10-5-2.5	13164	13364
800-400-200	10-5-2.5	13165	13365
1000-500-250	10-5-2.5	13166	13366
	15-7.5-2.5	13167	13367



Snap-on mounting

Primary conductor	40 x 10 mm 2 x 30 x 5 mm
Round conductor	Ø 32 mm
Transformer width	71 mm
Snap-on mounting	Art.-no. 55012 see page 204
Sealed shutter	Art.-no. 59041 see page 205
Protection plug-in current transformer	see page 133
Current transformer for tariff applications	see page 174



ASK 41.5

Plug-in current transformer

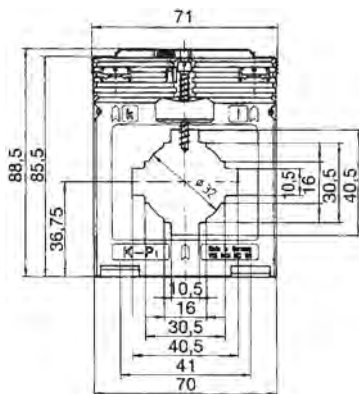
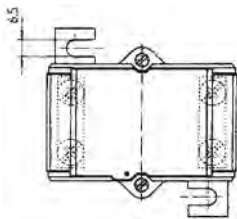
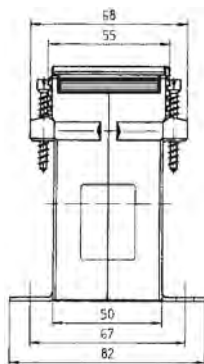

Primary conductor	40 x 10 mm 2 x 30 x 5 mm
Round conductor	Ø 32 mm
Transformer width	71 mm
Snap-on mounting	Art.-no. 55011 see page 204
Sealed shutter	Art.-no. 59041 see page 205
Current transformer for tariff applications	see page 175

Secondary current		5A		1A	
Primary current A	Burden VA	Accuracy class		Accuracy class	
		1	0.5	1	0.5
		Art.-no.	Art.-no.	Art.-no.	Art.-no.
50	1,5	1010006001		1010206001	
60	1,5	1010006002		1010206002	
	2,5	1010006003		1010206003	
75	1,5	1010006004	1010005001	1010206004	1010205001
	2,5	1010006005	1010005002	1010206005	1010205002
80	1,5	1010006006	1010005003	1010206006	1010205003
	2,5	1010006007	1010005004	1010206007	1010205004
100	1,5	1010006008	1010005005	1010206008	1010205005
	2,5	1010006009	1010005006	1010206009	1010205006
	3,75			1010206010	
150	2,5	1010006010	1010005007	1010206011	1010205007
	5	1010006011	1010005008	1010206012	1010205008
	7,5	1010006012	1010005009	1010206013	1010205009
200	2,5	1010006013	1010005010	1010206014	1010205010
	5	1010006014	1010005011	1010206015	1010205011
	10			1010206016	1010205012
250	2,5	1010006015	1010005012	1010206017	1010205013
	5	1010006016	1010005013	1010206018	1010205014
	10	1010006017	1010005014	1010206019	1010205015
	15			1010206020	1010205016
300	2,5	1010006018	1010005015	1010206021	1010205017
	5	1010006019	1010005016	1010206022	1010205018
	10	1010006020	1010005017	1010206023	1010205019
	15	1010006021	1010005018	1010206024	1010205020
400	2,5	1010006022	1010005019	1010206025	1010205021
	5	1010006023	1010005020	1010206026	1010205022
	10	1010006024	1010005021	1010206027	1010205023
	15	1010006025	1010005022	1010206028	1010205024
500	2,5	1010006026	1010005023	1010206029	1010205025
	5	1010006027	1010005024	1010206030	1010205026
	10	1010006028	1010005025	1010206031	1010205027
	15	1010006029	1010005026	1010206032	1010205028
600	2,5	1010006030	1010005027	1010206033	1010205029
	5	1010006031	1010005028	1010206034	1010205030
	10	1010006032	1010005029	1010206035	1010205031
	15	1010006033	1010005030	1010206036	1010205032
750	2,5	1010006034	1010005031	1010206037	1010205033
	5	1010006035	1010005032	1010206038	1010205034
	10	1010006036	1010005033	1010206039	1010205035
	15	1010006037	1010005034	1010206040	1010205036
800	2,5	1010006038	1010005035	1010206041	1010205037
	5	1010006039	1010005036	1010206042	1010205038
	10	1010006040	1010005037	1010206043	1010205039
	15	1010006041	1010005038	1010206044	1010205040
1000	2,5	1010006042	1010005039	1010206045	1010205041
	5	1010006043	1010005040	1010206046	1010205042
	10	1010006044	1010005041	1010206047	1010205043
	15	1010006045	1010005042	1010206048	1010205044



ASK 412.4

Plug-in current transformer

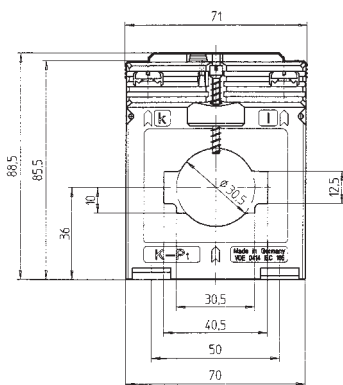
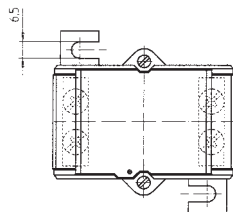
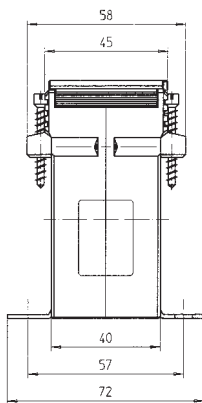

Primary conductor	40 x 12 mm 30 x 15 mm
Round conductor	Ø 30.5 mm
Transformer width	71 mm
Snap-on mounting	Art.-no. 55012 see page 204
Sealed shutter	Art.-no. 59041 see page 205

Secondary current		5A		1A	
Primary current A	Burden VA	Accuracy class		Accuracy class	
		1	0.5	1	0.5
		Art.-no.	Art.-no.	Art.-no.	Art.-no.
50	1.25	28036		28236	
	1.5	28037		28237	
60	1.25	28038		28238	
	1.5	28039		28239	
75	1.5	28040		28240	
	2.5	28041		28241	
80	1.5	28042		28242	
	2.5	28043		28243	
100	1.5	28044	28011	28244	28211
	2.5	28045		28245	
	3.75	28046		28246	
150	1.5	28047	28012	28247	28212
	2.5	28048	28013	28248	28213
	5	28049		28249	
200	2.5	28051	28015	28251	28215
	5	28052		28252	
	10	28053		28253	
250	1.5	28054	28016	28254	28216
	2.5	28055	28017	28255	28217
	5	28056	28014	28256	28214
	10	28057		28257	28087
300	2.5	28058	28018	28258	28218
	5	28059	28019	28259	28219
	10	28060		28260	
	15	28061		28261	
400	2.5	28062	28020	28262	28220
	5	28063	28021	28263	28221
	10	28064	28009	28264	28209
	15	28065		28265	
500	2.5	28066	28022	28266	28222
	5	28067	28023	28267	28223
	10	28068	28024	28268	28224
	15	28069		28269	
600	2.5	28070	28025	28270	28225
	5	28071	28026	28271	28226
	10	28072	28027	28272	28227
	15	28073		28273	
750	5	28074	28028	28274	28228
	10	28075	28029	28275	28229
	15	28076	28010	28276	28210
	30	28077		28277	
800	5	28078	28030	28278	28230
	10	28079	28031	28279	28231
	15	28080	28035	28280	28235
	30	28081		28281	



ASK 412.4 2U

Plug-in current transformer

Secondary current		5A	1A
Primary current A	Burden VA	Accuracy class	Accuracy class
		1	1
		Art.-no.	Art.-no.
200-100	5-2.5	28133	28333
	10-5	28134	28334
300-150	5-2.5	28135	28335
	10-5	28136	28336
400-200	5-2.5	28137	28337
	10-5	28138	28338
500-250	5-2.5	28139	28339
	10-5	28140	28340
600-300	5-2.5	28141	28341
	10-5	28143	28343
800-400	5-2.5	28144	28344
	10-5	28145	28345
	15-7.5		

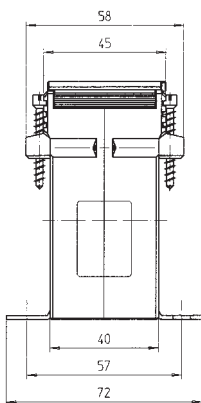

ASK 412.4 3U

Secondary current		5A	1A
Primary current A	Burden VA	Accuracy class	Accuracy class
		1	1
		Art.-no.	Art.-no.
400-200-100	10-5-2.5	28163	28363
	15-7.5-2.5		
600-300-150	10-5-2.5	28164	28364
800-400-200	10-5-2.5	28165	28365

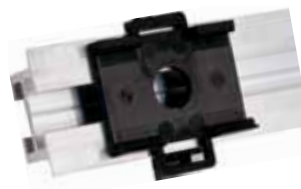
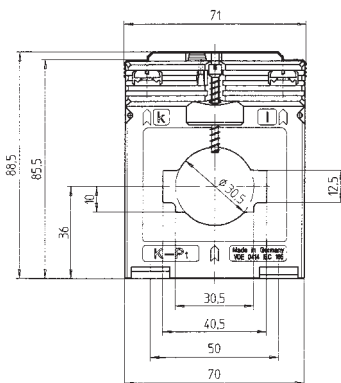
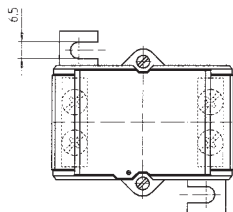

Snap-on mounting

Primary conductor	40 x 12 mm 30 x 15 mm
Round conductor	Ø 30.5 mm
Transformer width	71 mm
Snap-on mounting	Art.-no. 55012 see page 204
Sealed shutter	Art.-no. 59041 see page 205



ASK 41.6

Plug-in current transformer

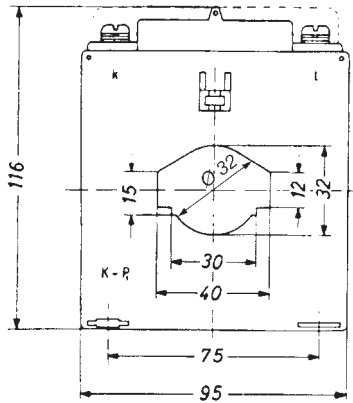
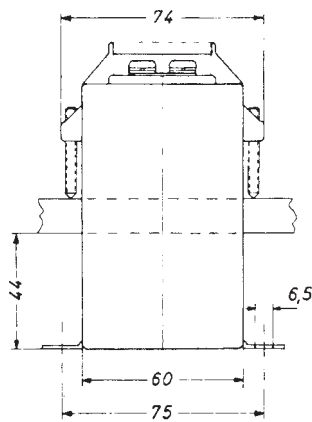

Primary conductor	40 x 12 mm 30 x 15 mm
Round conductor	Ø 32 mm
Transformer width	95 mm
Snap-on mounting	—
Sealed shutter	Art.-no. 59044 see page 205
Protection plug-in current transformer	see page 134
Current transformer for tariff applications	see page 176

Secondary current		5A		1A	
Primary current A	Burden VA	Accuracy class		Accuracy class	
		1	0.5	1	0.5
		Art.-no.	Art.-no.	Art.-no.	Art.-no.
50	1.5	14060	14011	14260	14211
	2.5	14061		14261	
60	1.5	14062	14012	14262	14212
	2.5	14063		14263	
75	1.5	14064		14264	
	2.5	14065	14013	14265	14213
	5	14066	14014	14266	14214
80	2.5	14067	14015	14267	14215
	5	14068	14016	14268	14216
100	2.5	14069	14017	14269	14217
	5	14070	14018	14270	14218
	10	14071	14019	14271	14219
150	2.5		14020		14220
	5	14072	14021	14272	14221
	10	14073	14022	14273	14222
	15	14074	14023	14274	14223
200	2.5		14024		14224
	5	14075	14025	14275	14225
	10	14076	14026	14276	14226
	15	14077	14027	14277	14227
250	2.5				14228
	5	14078	14029	14278	14229
	10	14079	14030	14279	14230
	15	14080	14031	14280	14231
300	2.5		14032		14232
	5	14081	14033	14281	14233
	10	14082	14034	14282	14234
	15	14083	14035	14283	14235
400	2.5		14036		14236
	5	14084	14037	14284	14237
	10	14085	14038	14285	14238
	15	14086	14039	14286	14239
500	2.5		14040		14240
	5	14087	14041	14287	14241
	10	14088	14042	14288	14242
	15	14089	14043	14289	14243
600	5		14044		14244
	10	14090	14045	14290	14245
	15	14091	14046	14291	14246
	30	14092	14047	14292	14247
750	5		14048		14248
	10	14094	14049	14294	14249
	15	14095	14050	14295	14250
	30	14096	14051	14296	14251
800	10	14098	14053	14298	14253
	15	14099	14054	14299	14254
	30	14100	14055	14300	14255
1000	5		14056		14256
	10	14102	14057	14302	14257
	15	14103	14058	14303	14258
	30	14104	14059	14304	14259
	45	14105		14305	

Plug-in current transformers

ASK 541.4

Primary conductor

40 x 10 mm

Round conductor
Transformer width

2 x 30 x 5 mm

Ø 32 mm

86 mm

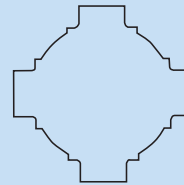

ASK 51.4

Primary conductor

50 x 12 mm

ASK 51.4 2U

Round conductor

2 x 40 x 10 mm

Ø 44 mm

ASK 51.4 3U

Transformer width

86 mm

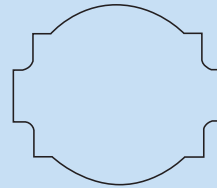

ASK 51.6

Primary conductor

50 x 12 mm

Round conductor
Transformer width

40 x 30 mm

Ø 40 mm

95 mm

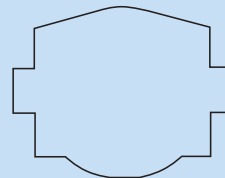

ASK 561.4

Primary conductor

60 x 10 mm

Round conductor
Transformer width

30 x 40 mm

2 x 50 x 10 mm

Ø 44 mm

86 mm

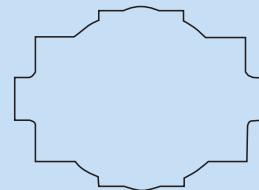



ASK 541.4

Plug-in current transformer

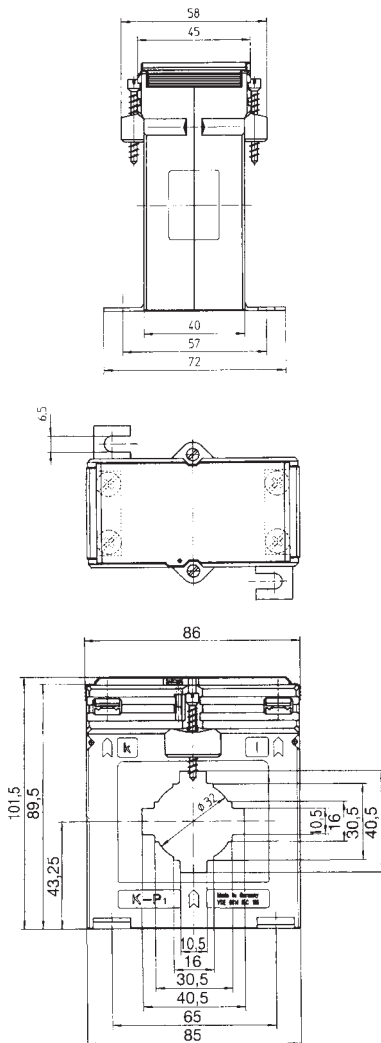

Primary conductor	40 x 10 mm 2 x 30 x 5 mm
Round conductor	Ø 32 mm
Transformer width	86 mm
Snap-on mounting	—
Sealed shutter	Art.-no. 59042 see page 205
Protection plug-in current transformer	see page 140
Current transformer for tariff applications	see page 177

Secondary current		5A			1A	
Primary current A	Burden VA	Accuracy class			Accuracy class	
		1	0.5	0.2s	1	0.5
		Art.-no.	Art.-no.	Art.-no.	Art.-no.	Art.-no.
30	1				15248	
	1.5	15048				
40	1.5	15049			15249	
	2.5	15050			15250	
50	1.5	15051			15251	
	2.5	15052			15252	
60	1.5	15053	15013		15253	15213
	2.5	15054			15254	
75	1.5	15055	15014		15255	15214
	2.5	15056	15100		15256	15300
80	1.5		15015			15215
	2.5	15057	15016		15257	15216
100	5	15058			15258	
	1.5			V33-1304C		
	2.5		15017	V33-1304D		15217
	5	15059	15018		15259	15218
125	10	15060			15260	
	2.5		15019			15219
	5	15061	15020		15261	15220
150	10	15062			15262	
	2.5	15063	15021	V33-1604D	15263	15221
	5	15064	15022	V33-1604F	15264	15222
200	10	15065	15343		15265	
	2.5		15023	V33-1704D		15223
	5	15066	15024	V33-1704F	15266	15224
250	10	15067	15101		15267	15301
	15	15068	15102		15268	15302
	2.5		15025	V33-1804D		15225
	5	15069	15026	V33-1804F	15269	15226
300	10	15070	15103	V33-1804H	15270	15303
	15	15071	15104		15271	15304
	2.5		15027	V33-1904D		15227
	5	15072	15028	V33-1904F	15272	15228
400	10	15073	15029	V33-1904H	15273	15229
	15	15074	15105		15274	15305
	2.5		15030	V33-2004D		15230
	5	15075	15031	V33-2004F	15275	15231
500	10	15076	15032	V33-2004H	15276	15232
	15	15077			15277	15339
	2.5		15033	V33-2104D		15233
	5		15034	V33-2104F		15234
600	10	15078	15035	V33-2104H	15278	15235
	15	15079	15035	V33-2104J	15279	15235
	30	15080	15344		15280	
	2.5		15036	V33-2204D		15236
750	5		15037	V33-2204F		15237
	10	15081	15037	V33-2204H	15281	15237
	15	15082	15038	V33-2204J	15282	15238
	30	15083	15039		15283	15239
800	2.5		15036	V33-2204D		15236
	5		15037	V33-2204F		15237
	10	15084	15040	V33-2304H	15284	15240
	15	15085	15041	V33-2304J	15285	15241
1000	30	15086	15042		15286	15242
	2.5		15043	V33-2504D		15243
	5	15087	15043	V33-2504F	15287	15243
	10	15088	15044		15288	15244
1000	15	15088	15044		15288	15244
	30	15089	15106		15289	15306
	2.5		15045	V33-2504D		15245
	5		15046	V33-2504F		15246
1000	10	15090	15046	V33-2504H	15290	15246
	15	15091	15047	V33-2504J	15291	15247
	30	15092			15292	



ASK 51.4

Plug-in current transformer

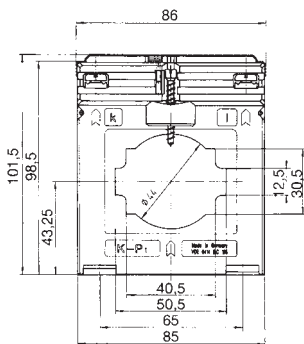
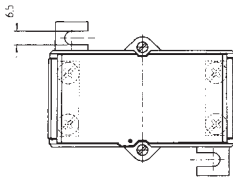
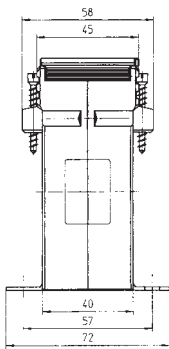

Primary conductor	50 x 12 mm 2 x 40 x 10 mm
Round conductor	Ø 44 mm
Transformer width	86 mm
Snap-on mounting	—
Sealed shutter	Art.-no. 59042 see page 205
Protection plug-in current transformer	see page 142
Current transformer for tariff applications	see page 178

Secondary current		5A			1A	
Primary current A	Burden VA	Accuracy class			Accuracy class	
		1	0.5	0.2s	1	0.5
		Art.-no.	Art.-no.	Art.-no.	Art.-no.	Art.-no.
100	1.5	16043	16170		16243	
	2.5	16086	16171			
150	1.5	16044	16011		16244	16211
	2.5	16045	16010		16245	16210
200	1.5		16012	V34-1704C		16212
	2.5	16046	16013	V34-1704D	16246	16213
	5	16047	16152	V34-1704F	16247	16352
250	1.5		16014			16214
	2.5	16048	16015	V34-1804D	16248	16215
	5	16049	16153	V34-1804F	16249	16353
	10	16177			16390	
300	2.5	16050	16017	V34-1904D	16250	16217
	5	16051	16018	V34-1904F	16251	16218
	10	16052			16252	
400	2.5	16053	16019	V34-2004D	16253	16219
	5	16054	16020	V34-2004F	16254	16220
	10	16055	16021	V34-2004H	16255	16221
	15	16056	16201		16256	
	500	2.5	16057	16022	V34-2104D	16257
500	5	16058	16023	V34-2104F	16258	16223
	10	16059	16024	V34-2104H	16259	16224
	15	16060	16202		16260	
	600	2.5	16061	16025	V34-2204D	16261
600	5	16062	16026	V34-2204F	16262	16226
	10	16063	16027	V34-2204H	16263	16227
	15	16064	16154		16264	16354
	750	2.5	16065	16028	V34-2304D	16265
750	5	16066	16029	V34-2304F	16266	16229
	10	16067	16030	V34-2304H	16267	16230
	15	16068	16203		16268	
	800	5	16069	16031	V34-2404F	16269
800	10	16070	16032	V34-2404H	16270	16232
	15	16071	16033		16271	16233
	30	16072			16272	
	1000	2.5			V34-2504D	
1000	5	16073	16034	V34-2504F	16273	16234
	10	16074	16035	V34-2504H	16274	16235
	15	16075	16036	V34-2504J	16275	16236
	30	16076			16276	
	1200	5	16077	16037		16277
1200	10	16078	16038		16278	16238
	15	16079	16039		16279	16239
	30	16080			16280	
1250	5	16081	16040		16281	16240
1250	10	16082	16041		16282	16241
	15	16083	16042		16283	16242
	30	16084			16284	

Change-over transformers see page 66.



ASK 51.4 2U

Plug-in current transformer

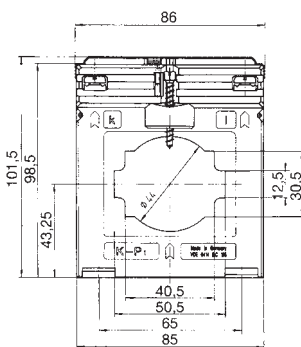
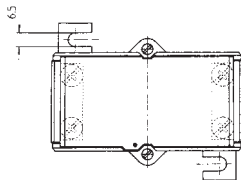
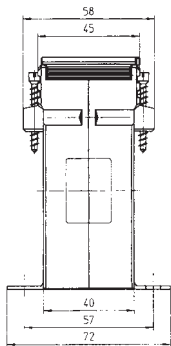

Secondary current		5A	1A
Primary current A	Burden VA	Accuracy class	Accuracy class
		1	1
		Art.-no.	Art.-no.
400-200	5-2.5	16130	16330
	10-5	16131	16331
500-250	5-2.5	16132	16332
	10-5	16133	16333
600-300	5-2.5	16134	16334
	10-5	16135	16335
800-400	5-2.5	16136	16336
	10-5	16137	16337
	15-7.5	16138	16338
1000-500	5-2.5	16139	16339
	10-5	16140	16340
	15-7.5	16141	16341
1200-600	5-2.5	16142	16342
	10-5	16143	16343
	15-7.5	16144	16344
	30-15	16145	16345

ASK 51.4 3U

Secondary current		5A	1A
Primary current A	Burden VA	Accuracy class	Accuracy class
		1	1
		Art.-no.	Art.-no.
800-400-200	10-5-2.5	16162	16362
1000-500-250	10-5-2.5	16163	16363
	15-7.5-2.5	16164	16364
1200-600-300	10-5-2.5	16165	16365
	15-7.5-2.5	16166	16366
1200-1000-300	7.5-5-2.5	16174	16374
1000-600-400	10-5-2.5	16175	16375
1000-600-300	15-10-5	16176	16376
600-400-200	15-7.5-5	16178	16378
1000-800-600	15-10-5	16179	16379
1000-600-300	10-5-2.5	16180	16380

Primary conductor	50 x 12 mm 2 x 40 x 10 mm
Round conductor	Ø 44 mm
Transformer width	86 mm
Snap-on mounting	—
Sealed shutter	Art.-no. 59042 see page 205
Protection plug-in current transformer	see page 142
Current transformer for tariff applications	see page 178



ASK 51.6

Plug-in current transformer

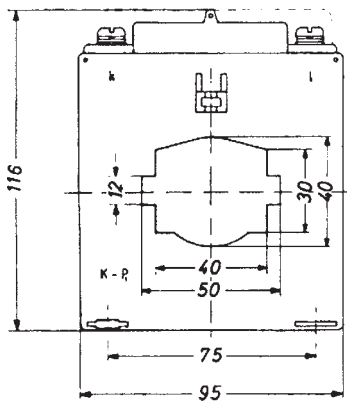
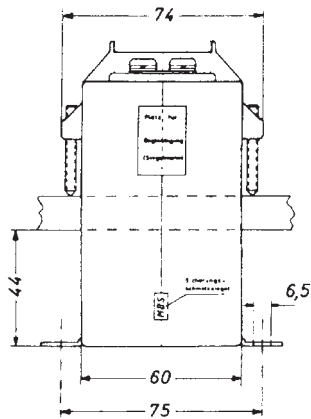

Primary conductor	50 x 12 mm 40 x 30 mm
Round conductor	Ø 40 mm
Transformer width	95 mm
Snap-on mounting	—
Sealed shutter	Art.-no. 59044 see page 205
Protection plug-in current transformer	see page 144
Current transformer for tariff applications	see page 179

Secondary current		5A		1A	
Primary current A	Burden VA	Accuracy class		Accuracy class	
		1	0.5	1	0.5
		Art.-no.	Art.-no.	Art.-no.	Art.-no.
100	2.5	17058	17011	17258	17211
	5	17059	17012	17259	17212
150	2.5	17060	17013	17260	17213
	5	17061	17014	17261	17214
	10	17062	17015	17262	17215
200	2.5	17063	17016	17263	17216
	5	17064	17017	17264	17217
	10	17065	17018	17265	17218
250	2.5	17066	17019	17266	17219
	5	17067	17020	17267	17220
	10	17068	17021	17268	17221
	15	17069	17022	17269	17222
300	2.5		17023		17223
	5	17070	17024	17270	17224
	10	17071	17025	17271	17225
	15	17072	17026	17272	17226
400	30		17073		17273
	2.5		17027		17227
	5	17074	17028	17274	17228
	10	17075	17029	17275	17229
	15	17076	17030	17276	17230
500	30		17077		17277
	2.5		17031		17231
	5	17078	17032	17278	17232
	10	17079	17033	17279	17233
	15	17080	17034	17280	17234
600	30		17081		17281
	2.5		17035		17235
	5	17082	17036	17282	17236
	10	17083	17037	17283	17237
	15	17084	17038	17284	17238
750	30		17085		17285
	2.5		17039		17239
	5	17086	17040	17286	17240
	10	17087	17041	17287	17241
	15	17088	17042	17288	17242
800	30		17089		17289
	10	17090	17044	17290	17244
	15	17091	17045	17291	17245
	30	17092		17292	
1000	45	17093		17293	
	5		17046		17246
	10	17094	17047	17294	17247
	15	17095	17048	17295	17248
	30	17096	17049	17296	17249
1200	45	17097		17297	
	5		17050		17250
	10	17098	17051	17298	17251
	15	17099	17052	17299	17252
	30	17100	17053	17300	17253
1250	45	17101		17301	
	5		17054		17254
	10	17102	17055	17302	17255
	15	17103	17056	17303	17256
	30	17104	17057	17304	17257
	45	17105		17305	



ASK 561.4

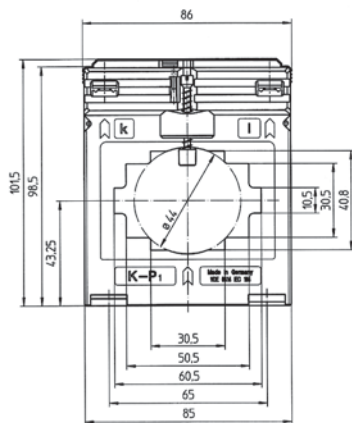
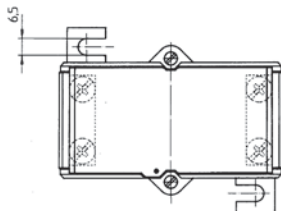
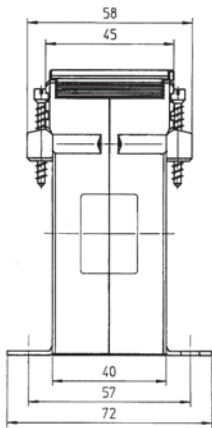

Plug-in current transformer



Secondary current		5A		1A	
Primary current A	Burden VA	Accuracy class		Accuracy class	
		1	0.5	1	0.5
		Art.-no.	Art.-no.	Art.-no.	Art.-no.
200	2.5	18036		18236	
250	2.5	18037		18237	
	5	18038		18238	
300	2.5	18039	18012	18239	18212
	5	18040	18013	18240	18213
400	2.5	18042	18014	18242	18214
	5	18043	18015	18243	18215
	10	18044		18244	
500	2.5		18016		18216
	5	18045	18017	18245	18217
	10	18046		18246	
	15	18047		18247	
600	2.5		18018		18218
	5	18048	18019	18248	18219
	10	18049	18020	18249	18220
	15	18050		18250	
750	2.5		18021		18221
	5	18051	18022	18251	18222
	10	18052	18023	18252	18223
	15	18053		18253	
800	5	18097	18024		18224
	10	18054	18025	18254	18225
	15	18055	18026	18255	18226
	30	18056		18256	
1000	5	18104	18027		18227
	10	18057	18028	18257	18228
	15	18058	18029	18258	18229
	30	18059		18259	
1200	5	18100	18030	18267	18230
	10	18060	18031	18260	18231
	15	18061	18032	18261	18232
	30	18062		18262	
1250	5	18102	18033		18233
	10	18063	18034	18263	18234
	15	18064	18035	18264	18235
	30	18065		18265	

Primary conductor	60 x 10 mm 30 x 40 mm 2 x 50 x 10 mm
Round conductor	Ø 44 mm
Transformer width	86 mm
Snap-on mounting	-
Sealed shutter	Art.-no. 59042 see page 205

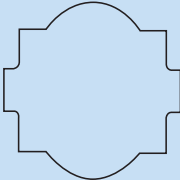
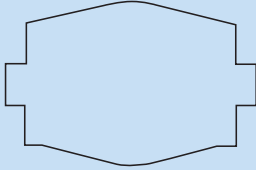
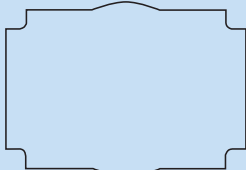
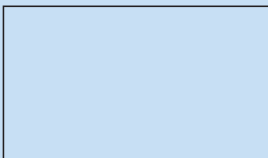
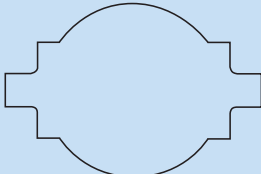
Plug-in current transformers

ASK 61.4	Primary conductor		63 x 10 mm	
	ASK 61.4 2U		2 x 50 x 10 mm	
	ASK 61.4 3U		Transformer width Ø 44 mm 96 mm	
ASK 61.6	Primary conductor		60 x 10 mm	
	Round conductor		50 x 30 mm	
	Transformer width		Ø 40 mm 95 mm	
ASK 63.4	Primary conductor		60 x 30 mm	
	Round conductor		50 x 40 mm	
	Transformer width		Ø 44 mm 96 mm	
ASK 63.6	Primary conductor		60 x 30 mm	
	Round conductor		Ø 30 mm	
	Transformer width		88 mm	
ASK 81.4	Primary conductor		80 x 10 mm	
			ASK 81.4 2U	60 x 30 mm
			ASK 81.4 3U	2 x 60 x 10 mm Ø 55 mm 120 mm
ASK 83.4	Primary conductor		84 x 34 mm	
	Round conductor		Ø 34 mm	
	Transformer width		96 mm	



ASK 61.4

Plug-in current transformer

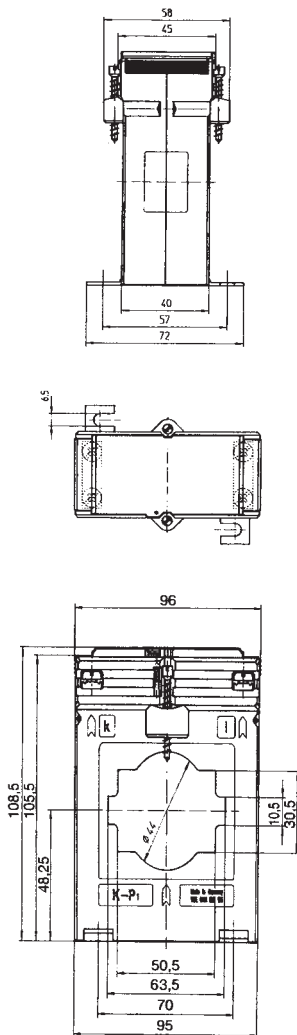

Secondary current		5A			1A	
Primary current A	Burden VA	Accuracy class			Accuracy class	
		1	0.5	0.2s	1	0.5
		Art.-no.	Art.-no.	Art.-no.	Art.-no.	Art.-no.
200	1.5	19047	19009		19247	19209
	2.5	19048	19010		19248	19210
250	1.5	19049	19011	V41-1804C	19249	19211
	2.5	19050	19012	V41-1804D	19250	19212
	5				19175	
300	1.5	19051	19013		19251	19213
	2.5	19052	19014	V41-1904D	19252	19214
	5	19053	19015	V41-1904F	19253	19215
400	1.5	19054	19016		19254	19216
	2.5	19055	19017	V41-2004D	19255	19217
	5	19056	19018	V41-2004F	19256	19218
	10	19057	19094	V41-2004H	19257	19294
500	1.5		19019			19219
	2.5	19058	19020	V41-2104D	19258	19220
	5	19059	19021	V41-2104F	19259	19221
	10	19060	19095	V41-2104H	19260	19295
	15	19061	19096		19261	19296
600	2.5	19062	19022	V41-2204D	19262	19222
	5	19063	19023	V41-2204F	19263	19223
	10	19064	19024	V41-2204H	19264	19224
	15	19065	19097	V41-2204J	19265	19297
750	2.5	19066	19025	V41-2304D	19266	19225
	5	19067	19026	V41-2304F	19267	19226
	10	19068	19027	V41-2304H	19268	19227
	15	19069	19098	V41-2304J	19269	19298
800	2.5	19070	19028		19270	19228
	5	19071	19029		19271	19229
	10	19072	19030		19272	19230
	15	19073	19031		19273	19231
1000	2.5			V41-2504D		
	5	19074	19032	V41-2504F	19274	19232
	10	19075	19033	V41-2504H	19275	19233
	15	19076	19034	V41-2504J	19276	19234
	30	19077	19099		19277	19299
1200	2.5			V41-2604D		
	5	19078	19035	V41-2604F	19278	19235
	10	19079	19036	V41-2604H	19279	19236
	15	19080	19037	V41-2604J	19280	19237
1250	30	19081	19100		19281	19300
	5	19082	19038	V41-2704F	19282	19238
	10	19083	19039	V41-2704H	19283	19239
	15	19084	19040	V41-2704J	19284	19240
1500	30	19085	19101		19285	19301
	5	19086	19041	V41-2804F	19286	19241
	10	19087	19042	V41-2804H	19287	19242
	15	19088	19043	V41-2804J	19288	19243
1600	30	19089	19102		19289	19302
	5	19090	19044		19290	19244
	10	19091	19045		19291	19245
	15	19092	19046		19292	19246
	30	19093	19103		19293	19303

Primary conductor	63 x 10 mm 2 x 50 x 10 mm
Round conductor	Ø 44 mm
Transformer width	96 mm
Snap-on mounting	—
Sealed shutter	Art.-no. 59042 see page 205
Protection plug-in current transformer	see page 148
Current transformer for tariff applications	see page 182



ASK 61.4 2U

Plug-in current transformer

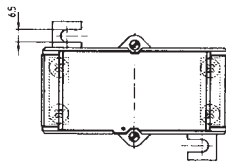
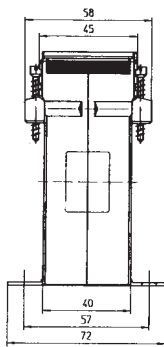

Secondary current		5A	1A
Primary current A	Burden VA	Accuracy class	Accuracy class
		1	1
		Art.-no.	Art.-no.
500-250	5-2.5	19141	19341
	5-2.5	19142	19342
	10-5	19143	19343
800-400	5-2.5	19144	19344
	10-5	19145	19345
	15-7.5	19146	19346
1000-500	5-2.5	19147	19347
	10-5	19148	19348
	15-7.5	19149	19349
1200-600	5-2.5	19150	19350
	10-5	19151	19351
	15-7.5	19152	19352
1500-750	5-2.5	19153	19353
	10-5	19154	19354
	15-7.5	19155	19355
	30-15	19156	19356
1600-800	5-2.5	19157	19357
	10-7.5	19158	19358
	15-7.5	19159	19359
	30-15	19160	19360

ASK 61.4 3U

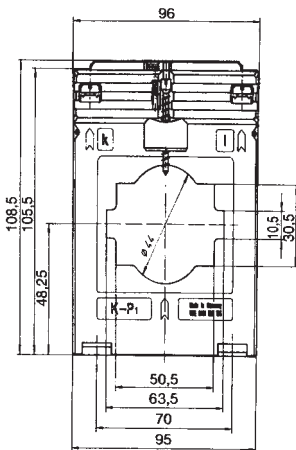

Secondary current		5A	1A
Primary current A	Burden VA	Accuracy class	Accuracy class
		1	1
		Art.-no.	Art.-no.
800-400-200	10-5-2.5	19182	19382
1000-500-250	10-5-2.5	19183	19383
	15-7.5-2.5	19184	19384
1000-600-300	10-5-2.5	19185	19385
	15-7.5-2.5	19186	19386
1200-600-300	10-5-2.5	19187	19387
	15-7.5-2.5	19188	19388
1500-750-400	10-5-2.5	19189	19389
	15-7.5-2.5	19190	19390
1600-800-400	10-5-2.5	19191	19391
	15-7.5-2.5	19192	19392
1000-600-400	10-5-2.5	19199	19399

Primary conductor	63 x 10 mm 2 x 50 x 10 mm
Round conductor	Ø 44 mm
Transformer width	96 mm
Snap-on mounting	—
Sealed shutter	Art.-no. 59042 see page 205
Protection plug-in current transformers	see page 148



ASK 61.6

Plug-in current transformer

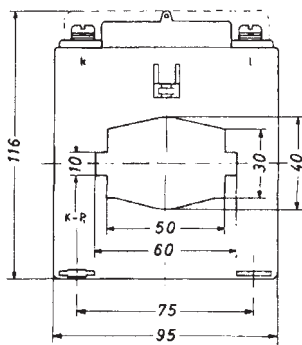
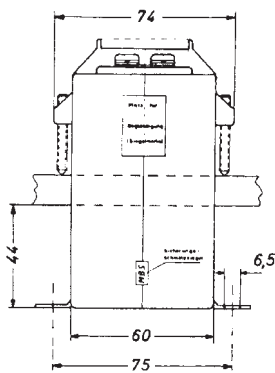

Primary conductor	60 x 10 mm 50 x 30 mm
Round conductor	Ø 40 mm
Transformer width	95 mm
Snap-on mounting	—
Sealed shutter	Art.-no. 59044 see page 205
Current transformer for tariff applications	see page 183

Secondary current		5A		1A	
Primary current A	Burden VA	Accuracy class		Accuracy class	
		1	0.5	1	0.5
		Art.-no.	Art.-no.	Art.-no.	Art.-no.
100	1.5	20063	20011	20263	20211
	2.5	20064		20264	
150	1.5	20065	20012	20265	20212
	2.5	20066	20013	20266	20213
200	2.5	20067	20014	20267	20214
	5	20068	20015	20268	20215
	10	20069		20269	
250	2.5	20116	20016	20321	20216
	5	20070	20017	20270	20217
	10	20071	20018	20271	20218
	15	20072		20272	
300	2.5	20117	20019	20322	20219
	5	20073	20020	20273	20220
	10	20074	20021	20274	20221
	15	20075	20022	20275	20222
400	2.5	20118	20023	20323	20223
	5	20076	20024	20276	20224
	10	20077	20025	20277	20225
	15	20078	20026	20278	20226
	30	20079		20279	
500	2.5	20119	20027	20324	20227
	5	20080	20028	20280	20228
	10	20081	20029	20281	20229
	15	20082	20030	20282	20230
	30	20083		20283	
600	2.5	20120	20031	20325	20231
	5	20084	20032	20284	20232
	10	20085	20033	20285	20233
	15	20086	20034	20286	20234
	30	20087		20287	
750	2.5	20121	20035	20326	20235
	5	20088	20036	20288	20236
	10	20089	20037	20289	20237
	15	20090	20038	20290	20238
	30	20091		20291	
800	5	20092	20040	20292	20240
	10	20093	20041	20293	20241
	15	20094	20042	20294	20242
	30	20095		20295	
1000	5	20122	20043	20327	20243
	10	20096	20044	20296	20244
	15	20097	20045	20297	20245
	30	20098	20046	20298	20246
	45	20099		20299	
1200	5	20123	20047	20328	20247
	10	20100	20048	20300	20248
	15	20101	20049	20301	20249
	30	20102	20050	20302	20250
	45	20103		20303	
1250	5	20124	20051	20329	20251
	10	20104	20052	20304	20252
	15	20105	20053	20305	20253
	30	20106	20054	20306	20254
	45	20107		20307	
1500	5	20125	20055	20330	20255
	10	20108	20056	20308	20256
	15	20109	20057	20309	20257
	30	20110	20058	20310	20258
	45	20111		20311	
1600	10	20112	20060	20312	20260
	15	20113	20061	20313	20261
	30	20114	20062	20314	20262
	45	20115		20315	



ASK 63.4

Plug-in current transformer

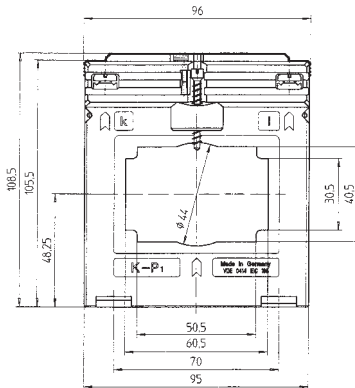
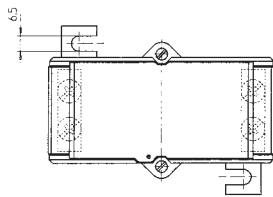
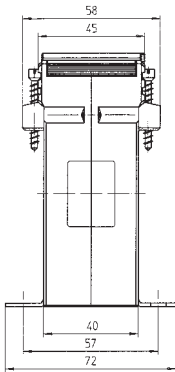

Secondary current		5A		1A	
Primary current A	Burden VA	Accuracy class		Accuracy class	
		1	0.5	1	0.5
		Art.-no.	Art.-no.	Art.-no.	Art.-no.
300	1.5	25041	25011	25241	25211
	2.5	25042	25012	25242	25212
400	2.5	25043	25013	25243	25213
	5	25044	25014	25244	25214
500	5	25045	25015	25245	25215
	10	25046		25246	
600	5	25047	25017	25247	25217
	10	25048	25018	25248	25218
	15	25049		25249	
750	5	25050	25020	25250	25220
	10	25051	25021	25251	25221
	15	25052	25022	25252	25222
800	5	25053	25023	25253	25223
	10	25054	25024	25254	25224
	15	25055	25025	25255	25225
1000	5	25056	25026	25256	25226
	10	25057	25027	25257	25227
	15	25058	25028	25258	25228
1200	5	25059	25029	25259	25229
	10	25060	25030	25260	25230
	15	25061	25031	25261	25231
1250	5	25062	25032	25262	25232
	10	25063	25033	25263	25233
	15	25064	25034	25264	25234
1500	5	25065	25035	25265	25235
	10	25066	25036	25266	25236
	15	25067	25037	25267	25237
1600	5	25068	25038	25268	25238
	10	25069	25039	25269	25239
	15	25070	25040	25270	25240
1800	5	25078	25071	25278	25271
	10	25079	25072	25279	25272
	15	25080	25073	25280	25273
2000	5	25081	25074	25281	25274
	10	25082	25076	25282	25276
	15	25083	25077	25283	25277

Primary conductor	60 x 30 mm 50 x 40 mm
Round conductor	Ø 44 mm
Transformer width	96 mm
Snap-on mounting	-
Sealed shutter	Art.-no. 59042 see page 205



ASK 63.6

Plug-in current transformer

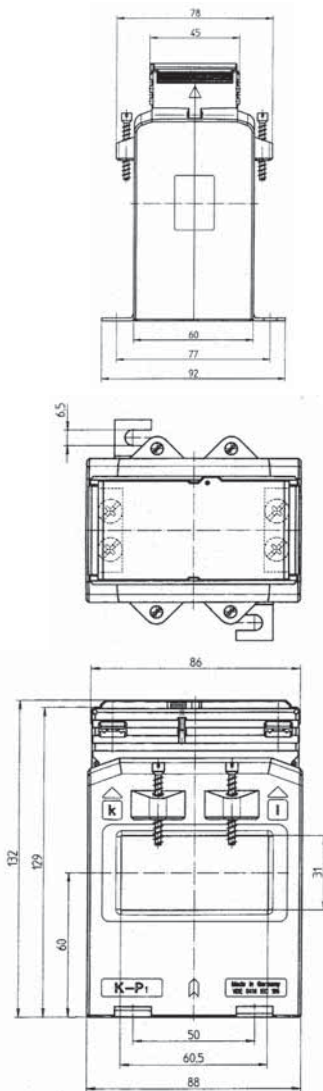

Primary conductor	60 x 30 mm
Round conductor	Ø 30 mm
Transformer width	88 mm
Snap-on mounting	—
Sealed shutter	Art.-no. 59042 see page 205
Protection plug-in current transformer	see page 152
Current transformer for tariff applications	see page 184

Secondary current		5A		1A	
Primary current A	Burden VA	Accuracy class		Accuracy class	
		1	0.5	1	0.5
		Art.-no.	Art.-no.	Art.-no.	Art.-no.
200	1.5	85060		85260	
	2.5	85061		85261	
250	1.5	85062	85011	85262	85211
	2.5	85063	85012	85263	85212
	5				
300	1.5	85064	85013	85264	85213
	2.5	85065	85014	85265	85214
	5	85066	85015	85266	85215
	10	85067		85267	
400	2.5	85068	85017	85268	85217
	5	85069	85018	85269	85218
	10	85071			
500	2.5	85073	85021	85273	85221
	5	85074	85022	85274	85222
	10	85075		85275	
	15	85076		85276	
600	2.5	85077	85025	85277	85225
	5	85078	85026	85278	85226
	10	85079	85027	85279	85227
	15	85080		85280	
750	2.5	85081	85029	85281	85229
	5	85082	85030	85282	85230
	10	85083	85031	85283	85231
	15	85084		85284	
	30				
800	2.5	85085	85033	85285	85233
	5	85086	85034	85286	85234
	10	85087	85035	85287	85235
	15	85088	85036	85288	85236
1000	5	85089	85037	85289	85237
	10	85090	85038	85290	85238
	15	85091	85039	85291	85239
	30	85092		85292	
1200	5	85093	85041	85293	85241
	10	85094	85042	85294	85242
	15	85095	85043	85295	85243
	30	85096	85044	85296	85244
1250	5	85097	85045	85297	85245
	10	85098	85046	85298	85246
	15	85099	85047	85299	85247
	30	85100		85300	
1500	5	85101	85049	85301	85249
	10	85102	85050	85302	85250
	15	85103	85051	85303	85251
	30	85104		85304	
1600	5	85105	85053	85305	85253
	10	85106	85054	85306	85254
	15	85107	85055	85307	85255
	30	85108		85308	
2000	5	85109	85056	85309	85256
	10	85110	85057	85310	85257
	15	85111	85058	85311	85258
	30	85112	85059	85312	85259

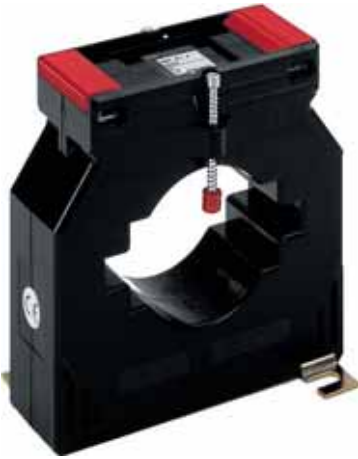

ASK 81.4

Plug-in current transformer

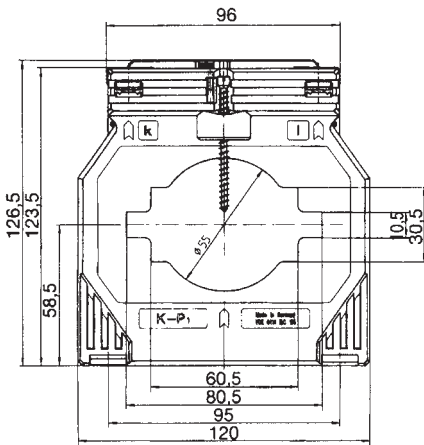
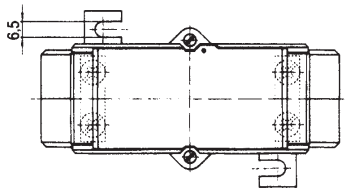
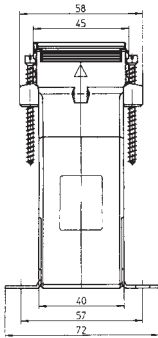

Primary conductor	80 x 10 mm 60 x 30 mm 2 x 60 x 10 mm
Round conductor	Ø 55 mm
Transformer width	120 mm
Snap-on mounting	—
Sealed shutter	Art.-no. 59042 see page 205
Current transformer for tariff applications	see page 185

Secondary current		5A			1A	
Primary current A	Burden VA	Accuracy class			Accuracy class	
		1	0.5	0.2s	1	0.5
		Art.-no.	Art.-no.	Art.-no.	Art.-no.	Art.-no.
400	2.5	21038	21009	V47-2004D	21238	21209
	5	21039	21010	V47-2004F	21239	21210
	10		21197			
500	2.5	21040	21011	V47-2104D	21240	21211
	5	21041	21135	V47-2104F	21241	21335
	10	21042	21078		21242	21278
600	2.5	21043	21012	V47-2204D	21243	21212
	5	21044	21013	V47-2204F	21244	21213
	10	21045	21014	V47-2204H	21245	21214
750	2.5	21046	21015	V47-2304D	21246	21215
	5	21047	21016	V47-2304F	21247	21216
	10	21048	21017	V47-2304H	21248	21217
	15	21049	21079		21249	21279
800	2.5	21050	21018		21250	21218
	5	21051	21019		21251	21219
	10	21052	21020		21252	21220
	15	21053	21080		21253	21280
1000	2.5	21084		V47-2504D		
	5	21054	21021	V47-2504F	21254	21221
	10	21055	21022	V47-2504H	21255	21222
	15	21056	21023	V47-2504J	21256	21223
	30	21057			21257	
1200	5	21058	21024	V47-2604F	21258	21224
	10	21059	21025	V47-2604H	21259	21225
	15	21060	21026	V47-2604J	21260	21226
	30	21061			21261	
1250	5	21062	21027	V47-2704F	21262	21227
	10	21063	21028	V47-2704H	21263	21228
	15	21064	21029	V47-2704J	21264	21229
	30	21065			21265	
1500	5	21085	21030	V47-2804F		21230
	10	21066	21031	V47-2804H	21266	21231
	15	21067	21032	V47-2804J	21267	21232
	30	21068			21268	
	45	21069			21269	
1600	5	21086	21033			21233
	10	21070	21034		21270	21234
	15	21071	21035		21271	21235
	30	21072			21272	
	45	21073			21273	
2000	10	21074	21036		21274	21236
	15	21075	21037		21275	21237
	30	21076			21276	
	45	21077			21277	

Change-over transformers see page 76.

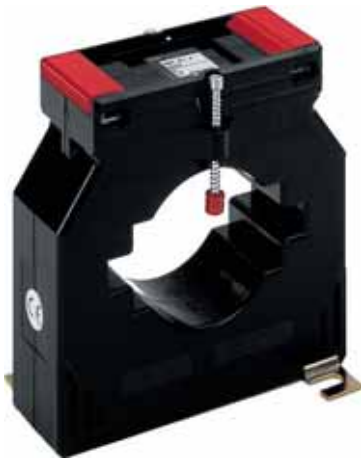

ASK 81.4 2U

Plug-in current transformer

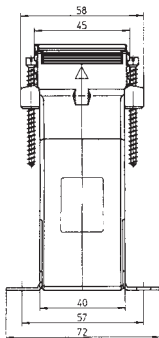

Secondary current		5A	1A
Primary current A	Burden VA	Accuracy class	Accuracy class
		1	1
		Art.-no.	Art.-no.
1000-500	10-5	21120	21320
	15-7.5	21121	21321
1200-600	10-5	21122	21322
	15-7.5	21123	21323
1500-750	10-5	21124	21324
	15-7.5	21125	21325
	30-15	21126	21326
1600-800	10-5	21127	21327
	15-7.5	21128	21328
	30-15	21129	21329
2000-1000	10-5	21130	21330
	15-7.5	21131	21331
	30-15	21132	21332

ASK 81.4 3U

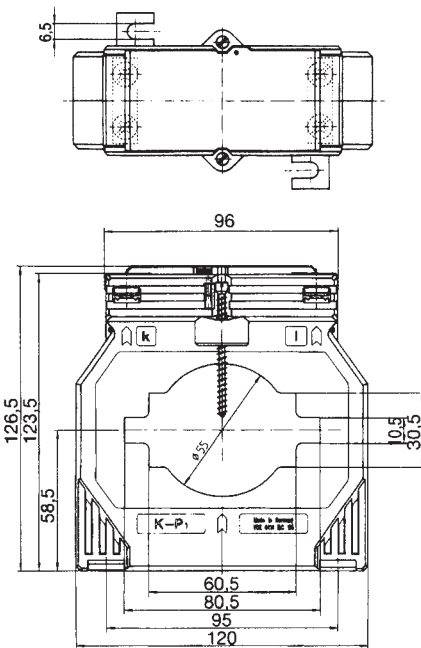

Secondary current		5A	1A
Primary current A	Burden VA	Accuracy class	Accuracy class
		1	1
		Art.-no.	Art.-no.
2000-1500-1000	30-15-10	21160	21360
2000-1000-500	30-10-5	21161	21361
1600-800-400	15-10-5	21162	21362
1500-1000-500	15-10-5	21163	21363
1200-800-600	15-10-5	21164	21364
1500-1000-750	15-10-5	21165	21365
1000-750-500	10-5-2.5	21166	21366

Primary conductor	80 x 10 mm 60 x 30 mm 2 x 60 x 10 mm
Round conductor	Ø 55 mm
Transformer width	120 mm
Snap-on mounting	—
Sealed shutter	Art.-no. 59042 see page 205



ASK 83.4

Plug-in current transformer

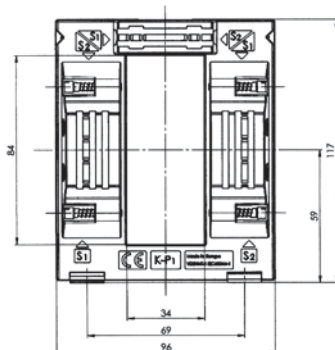
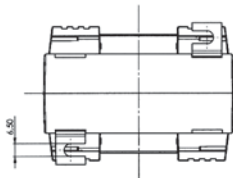
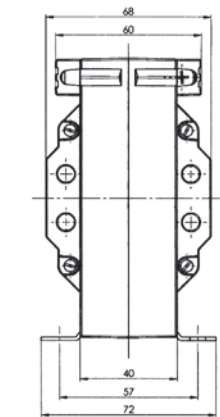

Secondary current		5A		1A	
Primary current A	Burden VA	Accuracy class		Accuracy class	
		1	0.5	1	0.5
		Art.-no.	Art.-no.	Art.-no.	Art.-no.
300	1.5	100051-x	100011-x	100251-x	100211-x
	2.5	100052-x	100012-x	100252-x	100212-x
400	2.5	100053-x	100013-x	100253-x	100213-x
	5	100054-x	100014-x	100254-x	100214-x
500	2.5	100055-x	100015-x	100255-x	100215-x
	5	100056-x	100016-x	100256-x	100216-x
600	2.5	100057-x	100017-x	100257-x	100217-x
	5	100058-x	100018-x	100258-x	100218-x
	10	100059-x		100259-x	
750	2.5	100060-x	100019-x	100260-x	100219-x
	5	100061-x	100020-x	100261-x	100220-x
	10	100062-x	100021-x	100262-x	100221-x
	15	100063-x		100263-x	
800	2.5	100064-x	100022-x	100264-x	100222-x
	5	100065-x	100023-x	100265-x	100223-x
	10	100066-x	100024-x	100266-x	100224-x
	15	100067-x		100267-x	
1000	5	100068-x	100025-x	100268-x	100225-x
	10	100069-x	100026-x	100269-x	100226-x
	15	100070-x	100027-x	100270-x	100227-x
1200	5	100071-x	100028-x	100271-x	100228-x
	10	100072-x	100029-x	100272-x	100229-x
	15	100073-x	100030-x	100273-x	100230-x
1250	5	100074-x	100031-x	100274-x	100231-x
	10	100075-x	100032-x	100275-x	100232-x
	15	100076-x	100033-x	100276-x	100233-x
1500	5	100077-x	100034-x	100277-x	100234-x
	10	100078-x	100035-x	100278-x	100235-x
	15	100079-x	100036-x	100279-x	100236-x
1600	5	100080-x	100037-x	100280-x	100237-x
	10	100081-x	100038-x	100281-x	100238-x
	15	100082-x	100039-x	100282-x	100239-x
	30	100083-x		100283-x	
1800	10	100084-x	100040-x	100284-x	100240-x
	15	100085-x	100041-x	100285-x	100241-x
	30	100086-x		100286-x	
2000	10	100087-x	100042-x	100287-x	100242-x
	15	100088-x	100043-x	100288-x	100243-x
	30	100089-x		100289-x	
2500	10	100090-x	100044-x	100290-x	100244-x
	15	100091-x	100045-x	100291-x	100245-x
	30	100092-x		100292-x	

Connection options see page 79.

Primary conductor	84 x 34 mm
Round conductor	Ø 34 mm
Transformer width	96 mm



ASK 83.4

Plug-in current transformer

Connection options

The plug-in current transformer ASK 83.4 is a multipurpose transformer which can be installed vertically or horizontally. There are 6 connection options to choose from.

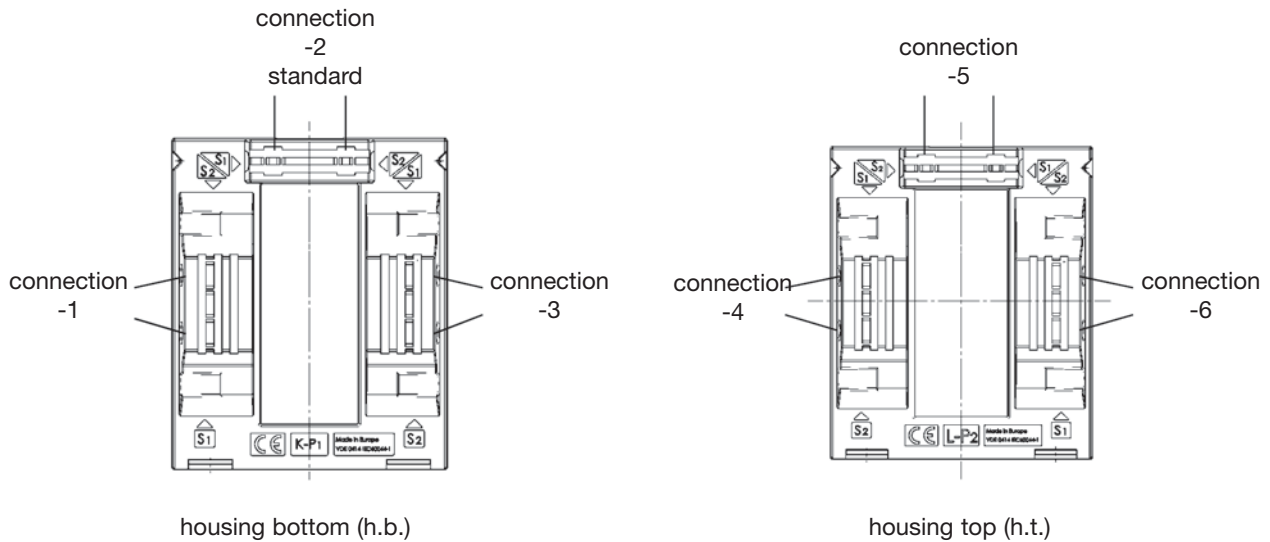



Order example

ASK 83.4 800/5 10/1

Connection option K-P₁ (h.b.) top

Art.-no. 100066-2

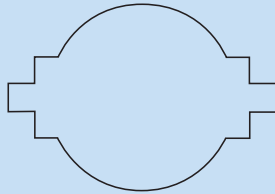
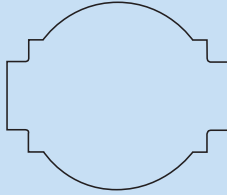
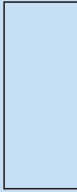
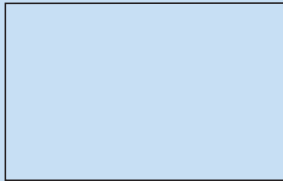
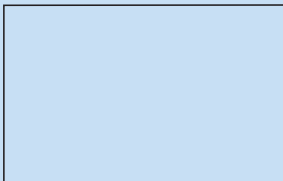
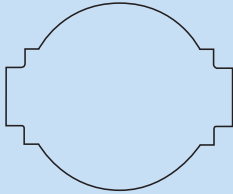
Plug-in current transformers

ASK 101.4 ASK 101.4 2U	Primary conductor		100 x 10 mm
	Round conductor Transformer width		2 x 80 x 10 mm Ø 70 mm 130 mm
ASK 103.3	Primary conductor		2 x 100 x 10 mm
	Round conductor Transformer width		3 x 80 x 10 mm Ø 85 mm 172 mm
ASK 103.41 ASK 103.41 2U	Primary conductor		103 x 41 mm
	Round conductor Transformer width		Ø 40 mm 99 mm
ASK 105.6	Primary conductor		100 x 55 mm
	Round conductor Transformer width		Ø 55 mm 129 mm
ASK 105.6N	Primary conductor		100 x 55 mm
	Round conductor Transformer width		Ø 55 mm 129 mm
ASK 123.3	Primary conductor		123 x 30 mm
	Round conductor Transformer width		3 x 100 x 10 mm Ø 100 mm 172 mm
ASK 127.4	Primary conductor		120 x 70 mm
	Round conductor Transformer width		Ø 70 mm 159 mm
ASK 127.6	Primary conductor		120 x 72 mm
	Round conductor Transformer width		Ø 72 mm 205 mm



ASK 101.4

Plug-in current transformer

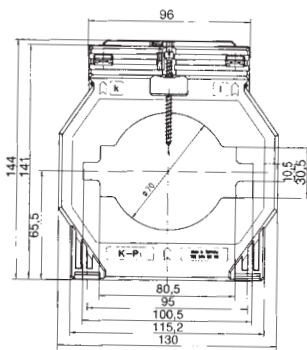
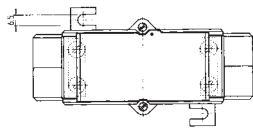
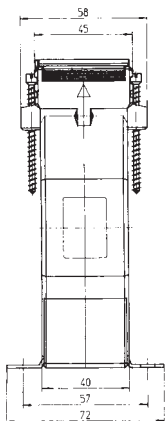

Secondary current		5A		1A	
Primary current A	Burden VA	Accuracy class		Accuracy class	
		1	0.5	1	0.5
		Art.-no.	Art.-no.	Art.-no.	Art.-no.
500	2.5		22009		22209
	5	22076	22010	22276	22210
	10	22077		22277	
600	2.5		22011		22211
	5	22038	22012	22238	22212
	10	22039	22239		
750	2.5		22013		22213
	5	22040	22014	22240	22214
	10	22041	22078	22241	22281
800	5	22042	22015	22242	22215
	10	22043	22016	22243	22216
	15	22044		22244	
1000	5	22045	22017	22245	22217
	10	22046	22018	22246	22218
	15	22047		22247	
	30	22115		22278	
1200	5	22048	22019	22248	22219
	10	22049	22020	22249	22220
	15	22050		22250	
	30	22051		22251	
1250	5	22052	22021	22252	22221
	10	22053	22022	22253	22222
	15	22054		22254	
	30	22055		22255	
1500	5	22056	22023	22256	22223
	10	22057	22024	22257	22224
	15	22058	22025	22258	22279
	30	22059		22259	
1600	5		22026		22226
	10	22060	22027	22260	22227
	15	22061	22028	22261	22228
	30	22062		22262	
	45	22063		22263	
1800	5		22029		22229
	10	22064	22030	22264	22230
	15	22065	22031	22265	22231
	30	22066		22266	
	45	22067		22267	
2000	5		22032		22232
	10	22068	22033	22268	22233
	15	22069	22034	22269	22234
	30	22070	22118	22270	22280
	45	22071		22271	
2500	5		22035		22235
	10	22072	22036	22272	22236
	15	22073	22037	22273	22237
	30	22074	22119	22274	22337
	45	22075		22275	

Primary conductor	100 x 10 mm 2 x 80 x 10 mm
Round conductor	Ø 70 mm
Transformer width	130 mm
Snap-on mounting	—
Sealed shutter	Art.-no. 59042 see page 205

ASK 101.4 2U

Plug-in current transformer

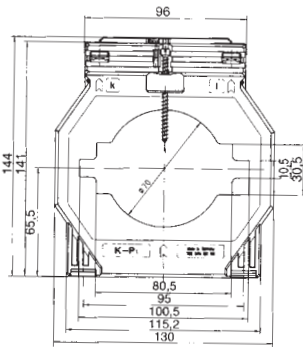
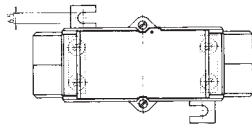
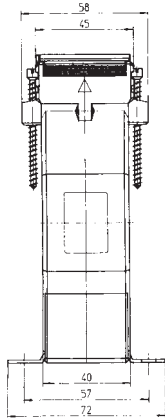

Secondary current		5A	1A
Primary current A	Burden VA	Accuracy class	Accuracy class
		1	1
		Art.-no.	Art.-no.
1200-600	10-5	22120	22320
	15-7.5	22121	22321
1500-750	10-5	22122	22322
	15-7.5	22123	22323
1600-800	10-5	22124	22324
	15-7.5	22125	22325
	30-15	22126	22326
2000-1000	10-5	22127	22327
	15-7.5	22128	22328
	30-15	22129	22329
2500-1250	10-5	22130	22330
	15-7.5	22131	22331
	30-15	22132	22332

Primary conductor	100 x 10 mm 2 x 80 x 10 mm
Round conductor	Ø 70 mm
Transformer width	130 mm
Snap-on mounting	—
Sealed shutter	Art.-no. 59042 see page 205



ASK 103.3

Plug-in current transformer

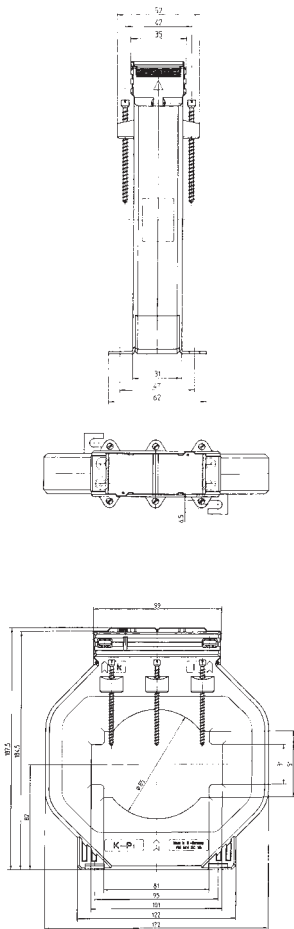

Secondary current		5A		1A	
Primary current A	Burden VA	Accuracy class		Accuracy class	
		1	0.5	1	0.5
		Art.-no.	Art.-no.	Art.-no.	Art.-no.
750	2.5		23011		23211
	5	23036		23236	
	10	23037		23237	
800	2.5		23012		23212
	5	23038	23013	23238	23213
	10	23039		23239	
	15	23040		23240	
1000	5	23041	23014	23241	23214
	10	23042	23015	23242	23215
	15	23043	23016	23243	23216
1200	5	23044	23017	23244	23217
	10	23045	23018	23245	23218
	15	23046	23019	23246	23219
	30	23047		23247	
1250	5	23048	23020	23248	23220
	10	23049	23021	23249	23221
	15	23050	23022	23250	23222
	30	23051		23251	
1500	10	23052	23023	23252	23223
	15	23053	23024	23253	23224
	30	23054		23254	
	45	23055		23255	
1600	10	23056	23025	23256	23225
	15	23057	23026	23257	23226
	30	23058		23258	
	45	23059		23259	
2000	10	23060	23027	23260	23227
	15	23061	23028	23261	23228
	30	23062	23029	23262	23229
	45	23063		23263	
2500	10	23064	23030	23264	23230
	15	23065	23031	23265	23231
	30	23066	23032	23266	23232
	45	23067		23267	
3000	10	23068	23033	23268	23233
	15	23069	23034	23269	23234
	30	23070	23035	23270	23235
	45	23071		23271	

Primary conductor	2 x 100 x 10 mm 3 x 80 x 10 mm
Round conductor	Ø 85 mm
Transformer width	172 mm
Snap-on mounting	—
Sealed shutter 2 pieces	Art.-no. 59040 see page 205



ASK 103.41

Plug-in current transformer

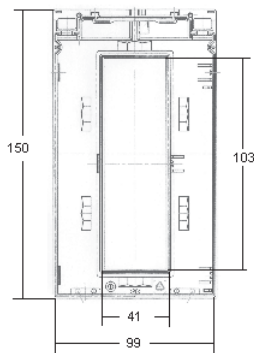
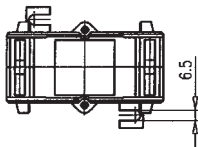
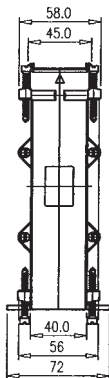

Secondary current		5A		1A	
Primary current A	Burden VA	Accuracy class		Accuracy class	
		1	0.5	1	0.5
		Art.-no.	Art.-no.	Art.-no.	Art.-no.
400	2.5	97051	97021	97251	97221
	5	97052		97252	
500	2.5	97053	97023	97253	97223
	5	97054		97254	
600	2.5	97055	97025	97255	97225
	5	97056		97256	
750	2.5	97057	97027	97257	97227
	5	97058		97258	
800	5	97059	97029	97259	97229
	10	97060		97260	
1000	10	97061	97031	97261	97231
	15	97062		97262	
1200	10	97063	97033	97263	97233
	15	97064		97264	
1250	10	97065	97035	97265	97235
	15	97066		97266	
1500	15	97067	97037	97267	97237
	30	97068		97268	
	30	97069	97039	97269	97239
2000	15	97069	97039	97269	97239
	30	97070		97270	

ASK 103.41 2U

Secondary current		5A		1A	
Primary current A	Burden VA	Accuracy class		Accuracy class	
		1	0.5	1	0.5
		Art.-no.	Art.-no.	Art.-no.	Art.-no.
1000-500	5-2.5	97081	97071	97281	97271
1200-600	5-2.5	97082	97072	97282	97272
1500-750	10-5	97083	97073	97283	97273
	15-7.5	97084		97284	
2000-1000	15-7.5	97085	97075	97285	97275
	30-15	97086		97286	

Primary conductor	103 x 41 mm
Round conductor	Ø 40 mm
Transformer width	99 mm
Snap-on mounting	—
Sealed shutter	—



ASK 105.6

Plug-in current transformer

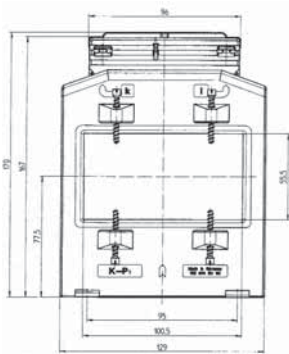
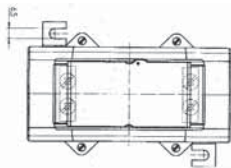
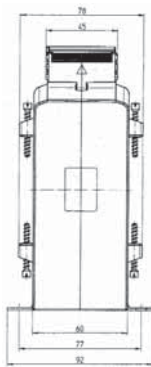

Primary conductor	100 x 55 mm
Round conductor	Ø 55 mm
Transformer width	129 mm
Snap-on mounting	—
Sealed shutter	Art.-no. 59042 see page 205
Protection plug-in current transformer	see page 153
Current transformer for tariff applications	see page 188

Secondary current		5A			1A	
Primary current A	Burden VA	Accuracy class			Accuracy class	
		1	0.5	0.2s	1	0.5
		Art.-no.	Art.-no.	Art.-no.	Art.-no.	Art.-no.
600	2.5		86083	V55-2204D		86283
	5	86092	86084		86292	86284
	10	86093			86293	
750	2.5		86086	V55-2304D		86286
	5	86095	86087	V55-2304F	86295	86287
	10	86096	86157		86296	
800	5	86097	86089	V55-2404F	86297	86289
	10	86098	86090	V55-2404H	86298	86290
1000	2.5		86158	V55-2504D		
	5	86051	86011	V55-2504F	86251	86211
	10	86052	86159	V55-2504H	86252	
	15		86160		86299	
1200	5	86053	86013	V55-2604F	86253	86213
	10	86054	86014	V55-2604H	86254	86214
	15	86055	86015		86255	86215
1250	5	86056	86016	V55-2704F	86256	86216
	10	86057	86017	V55-2704H	86257	86217
	15	86058	86018	V55-2704J	86258	86218
	30		86162			
1500	5	86059	86019	V55-2804F	86259	86219
	10	86060	86020	V55-2804H	86260	86220
	15	86061	86021	V55-2804J	86261	86221
	30	86062	86163		86262	
1600	5	86110	86164	V55-2904F		
	10	86142	86165	V55-2904H	86331	86338
	15	86101	86149	V55-2904J	86330	86339
	30	86138	86166		86337	86340
1800	5	86063	86023		86263	86223
	10	86064	86024		86264	86224
	15	86065	86025		86265	86225
	30	86066			86266	
2000	5		86167	V55-3004F		
	10	86067	86027	V55-3004H	86267	86227
	15	86068	86028	V55-3004J	86268	86228
	30	86069	86029		86269	86229
	45	86070			86270	
2400	5		86168	V55-3104F		
	10		86169	V55-3104H		
	15		86170	V55-3104J		
	30		86171			
2500	5		86172	V55-3204F		
	10	86071	86031	V55-3204H	86271	86231
	15	86072	86032	V55-3204J	86272	86232
	30	86073	86033		86273	86233
	45	86074			86274	
3000	5		86173	V55-3304F		
	10	86075	86035	V55-3304H	86275	86235
	15	86076	86036	V55-3304J	86276	86236
	30	86077	86037		86277	86237
	45	86078			86278	



ASK 105.6 N

Plug-in current transformer

Secondary current		5A		1A	
Primary current A	Burden VA	Accuracy class		Accuracy class	
		1	0.5	1	0.5
		Art.-no.	Art.-no.	Art.-no.	Art.-no.
2500	10	86451	86481	86411	86431
	15	86452	86482	86412	86432
	30	86453	86483	86413	86433
	45	86454		86414	
3000	10	86455	86484	86415	86434
	15	86456	86485	86416	86435
	30	86457	86486	86417	86436
	45	86458		86418	
4000	10	86459	86487	86419	86437
	15	86460	86488	86420	86438
	30	86461	86489	86421	86439
	45	86462		86422	
5000	10	86463	86490	86423	86440
	15	86464	86491	86424	86441
	30	86465	86492	86425	86442
	45	86466		86426	

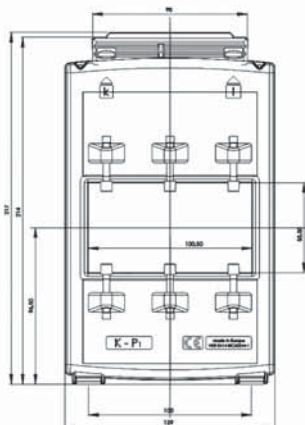
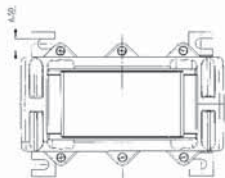
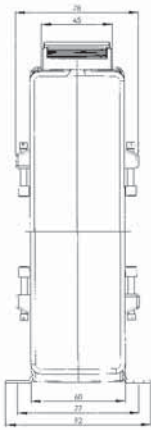

Primary conductor	100 x 55 mm
Round conductor	Ø 55 mm
Transformer width	129 mm
Snap-on mounting	—
Sealed shutter	Art.-no. 59042 see page 205



ASK 127.4

Plug-in current transformer

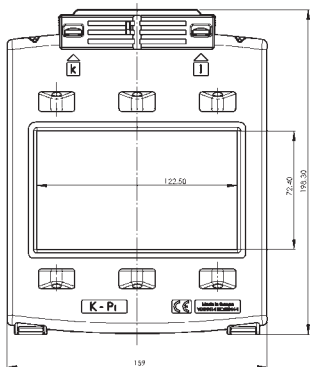
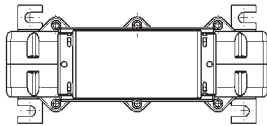
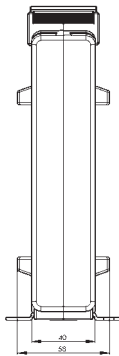

Secondary current		5A		1A	
Primary current A	Burden VA	Accuracy class		Accuracy class	
		1	0.5	1	0.5
		Art.-no.	Art.-no.	Art.-no.	Art.-no.
1000	5	87540	87510	87640	87610
	10	87541	87511	87641	87611
1200	5	87542	87512	87642	87612
	10	87543	87513	87643	87613
	15	87544	87514	87644	87614
1250	10	87545	87515	87645	87615
	15	87546	87516	87646	87616
	30	87547	87517	87647	87617
1500	10	87548	87518	87648	87618
	15	87549	87519	87649	87619
	30	87550	87520	87650	87620
1600	10	87551	87521	87651	87621
	15	87552	87522	87652	87622
	30	87553	87523	87653	87623
1800	10	87554	87524	87654	87624
	15	87555	87525	87655	87625
	30	87556	87526	87656	87626
2000	10	87557	87527	87657	87627
	15	87558	87528	87658	87628
	30	87559	87529	87659	87629
	45	87560	87530	87660	87630
2500	10	87561	87531	87661	87631
	15	87562	87532	87662	87632
	30	87563	87533	87663	87633
	45	87564	87534	87664	87634

Primary conductor	120 x 70 mm
Round conductor	Ø 70 mm
Transformer width	159 mm
Snap-on mounting	—
Sealed shutter	Art.-no. 59042 see page 205



ASK 127.6



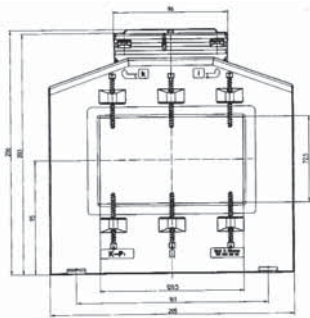
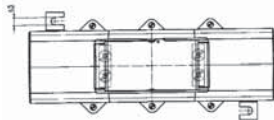
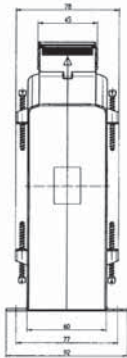

Plug-in current transformer

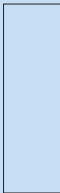

Secondary current		5A		1A	
Primary current A	Burden VA	Accuracy class		Accuracy class	
		1	0.5	1	0.5
		Art.-no.	Art.-no.	Art.-no.	Art.-no.
1000	5	87055	87011	87255	87211
	10	87056		87256	
1200	5	87057	87013	87257	87213
	10	87058	87014	87258	87214
	15	87059		87259	
1250	5	87060	87016	87260	87216
	10	87061	87017	87261	87217
	15	87062	87018	87262	87218
	30	87063	87019	87263	87219
1500	5	87064	87020	87264	87220
	10	87065	87021	87265	87221
	15	87066	87022	87266	87222
	30	87067	87023	87267	87223
1800	5	87068	87024	87268	87224
	10	87069	87025	87269	87225
	15	87070	87026	87270	87226
	30	87071	87027	87271	87227
2000	10	87072	87028	87272	87228
	15	87073	87029	87273	87229
	30	87074	87030	87274	87230
	45	87075		87275	
2500	10	87076	87032	87276	87232
	15	87077	87033	87277	87233
	30	87078	87034	87278	87234
	45	87079		87279	
3000	10	87081	87036	87281	87236
	15	87082	87037	87282	87237
	30	87083	87038	87283	87238
	45	87084		87284	
4000	10	87085	87040	87285	87240
	15	87086	87041	87286	87241
	30	87087	87042	87287	87242
	45	87088		87288	
5000	10	87089	87044	87289	87244
	15	87090	87045	87290	87245
	30	87091	87046	87291	87246
	45	87092		87292	
6000	10	87093	87048	87293	87248
	15	87094	87049	87294	87249
	30	87095	87050	87295	87250
	45	87096		87296	

Primary conductor	120 x 70 mm
Round conductor	Ø 70 mm
Transformer width	159 mm
Snap-on mounting	—
Sealed shutter	Art.-no. 59042 see page 205

Plug-in current transformers

ASK 128.4	Primary conductor Round conductor Transformer width		128 x 38 mm Ø 38 mm 100 mm
ASK 129.10	Primary conductor Round conductor Transformer width		120 x 90 mm Ø 90 mm 250 mm
ASK 130.3	Primary conductor Round conductor Transformer width		130 x 25 mm Ø 25 mm 180 mm
ASK 130.5	Primary conductor Round conductor Transformer width		130 x 30 mm Ø 30 mm 180 mm



ASK 128.4

Plug-in current transformer

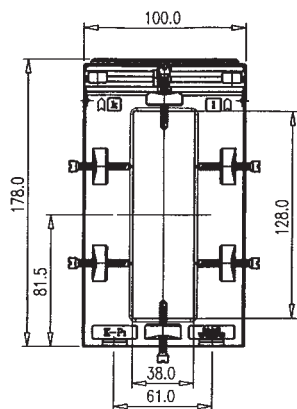
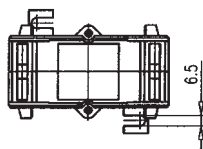
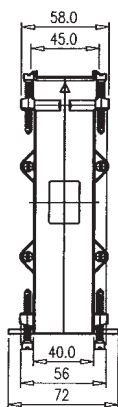

Secondary current		5A		1A	
Primary current A	Burden VA	Accuracy class		Accuracy class	
		1	0.5	1	0.5
		Art.-no.	Art.-no.	Art.-no.	Art.-no.
400	2.5	94041	94011	94241	94211
	5	94042		94242	
500	2.5	94043	94013	94243	94213
	5	94044		94244	
600	2.5	94045	94015	94245	94215
	5	94046		94246	
750	2.5	94047	94017	94247	94217
	5	94048		94248	
800	5	94049	94019	94249	94219
	10	94050		94250	
1000	10	94051	94021	94251	94221
	15	94052		94252	
1200	10	94053	94023	94253	94223
	15	94054		94254	
1250	10	94055	94025	94255	94225
	15	94056		94256	
1500	15	94057	94027	94257	94227
	30	94058		94258	
	30	94059	94029	94259	94229
2000	15	94059	94029	94259	94229
	30	94060		94260	
	30	94061	94031	94261	94231
2500	15	94061	94031	94261	94231
	30	94062		94262	

Primary conductor	128 x 38 mm
Round conductor	Ø 38 mm
Transformer width	100 mm
Snap-on mounting	—
Sealed shutter	Art.-no. 59042 see page 205



ASK 129.10

Plug-in current transformer

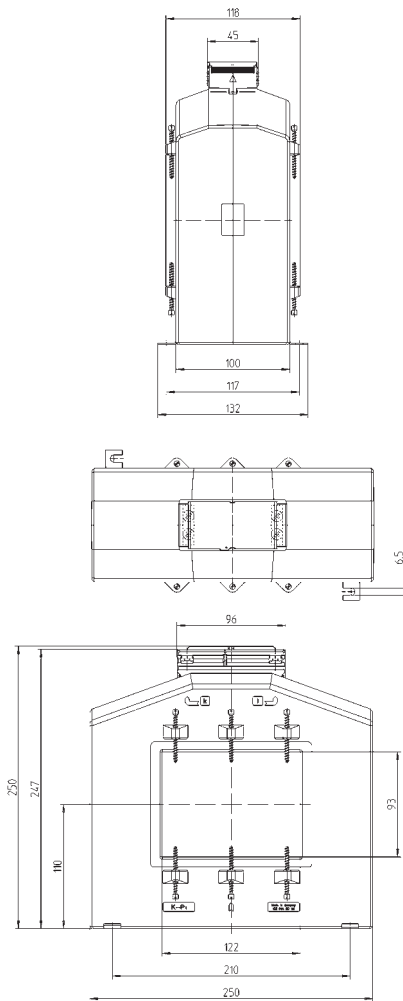

Secondary current		5A		1A	
Primary current A	Burden VA	Accuracy class		Accuracy class	
		1	0.5	1	0.5
		Art.-no.	Art.-no.	Art.-no.	Art.-no.
1000	5	88070	88011	88270	88211
	10	88071		88271	
	15	88072		88272	
1200	5	88073	88014	88273	88214
	10	88074	88015	88274	88215
	15	88075		88275	
1250	5	88076	88017	88276	88217
	10	88077	88018	88277	88218
	15	88078		88278	
1500	10	88079	88020	88279	88220
	15	88080	88021	88280	88221
	30	88081	88022	88281	88222
1600	10	88082	88023	88282	88223
	15	88083	88024	88283	88224
	30	88084	88025	88284	88225
1800	10	88085	88026	88285	88226
	15	88086	88027	88286	88227
	30	88087	88028	88287	88228
2000	10	88088	88029	88288	88229
	15	88089	88030	88289	88230
	30	88090	88031	88290	88231
2500	15	88091	88032	88291	88232
	30	88092	88033	88292	88233
	45	88093	88034	88293	88234
3000	15	88094	88035	88294	88235
	30	88095	88036	88295	88236
	45	88096	88037	88296	88237
4000	15	88097	88038	88297	88238
	30	88098	88039	88298	88239
	45	88099	88040	88299	88240
5000	15	88100	88041	88300	88241
	30	88101	88042	88301	88242
	45	88102	88043	88302	88243
6000	15	88103	88044	88303	88244
	30	88104	88045	88304	88245
	45	88105	88046	88305	88246
7500	15	88106	88047	88306	88247
	30	88107	88048	88307	88248
	45	88108	88049	88308	88249

Primary conductor	120 x 90 mm
Round conductor	Ø 90 mm
Transformer width	250 mm
Snap-on mounting	—
Sealed shutter	Art.-no. 59042 see page 205



ASK 130.3

Plug-in current transformer

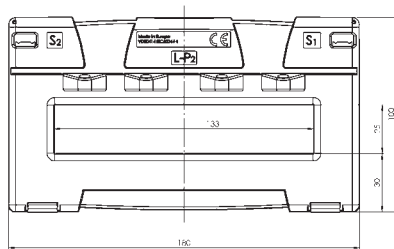
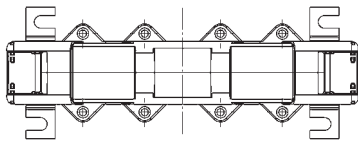
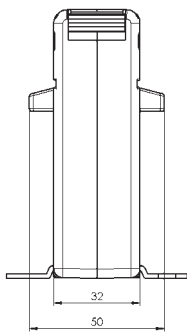

Secondary current		5A			1A	
Primary current A	Burden VA	Accuracy class			Accuracy class	
		1	0.5	0.2s	1	0.5
		Art.-no.	Art.-no.	Art.-no.	Art.-no.	Art.-no.
300	2.5	I50-1900D	I50-1901D		I50-1910D	I50-1911D
	5	I50-1900F	I50-1901F		I50-1910F	I50-1911F
400	2.5	I50-2000D	I50-2001D		I50-2010D	I50-2011D
	5	I50-2000F	I50-2001F		I50-2010F	I50-2011F
	10	I50-2000H	I50-2001H		I50-2010H	I50-2011H
500	2.5	I50-2100D	I50-2101D		I50-2110D	I50-2111D
	5	I50-2100F	I50-2101F		I50-2110F	I50-2111F
	10	I50-2100H	I50-2101H		I50-2110H	I50-2111H
600	2.5	I50-2200D	I50-2201D		I50-2210D	I50-2211D
	5	I50-2200F	I50-2201F		I50-2210F	I50-2211F
	10	I50-2200H	I50-2201H		I50-2210H	I50-2211H
	15	I50-2200J			I50-2210J	I50-2211J
750	2.5	I50-2300D	I50-2301D	V50-2304D	I50-2310D	I50-2311D
	5	I50-2300F	I50-2301F		I50-2310F	I50-2311F
	10	I50-2300H	I50-2301H		I50-2310H	I50-2311H
	15	I50-2300J	I50-2301J		I50-2310J	I50-2311J
1000	5	I50-2500F	I50-2501F	V50-2504F	I50-2510F	I50-2511F
	10	I50-2500H	I50-2501H	V50-2504H	I50-2510H	I50-2511H
	15	I50-2500J	I50-2501J		I50-2510J	I50-2511J
	30	I50-2500L			I50-2510L	I50-2511L
1200	5	I50-2600F	I50-2601F	V50-2604F	I50-2610F	I50-2611F
	10	I50-2600H	I50-2601H	V50-2604H	I50-2610H	I50-2611H
	15	I50-2600J	I50-2601J		I50-2610J	I50-2611J
	30	I50-2600L			I50-2610L	I50-2611L
1250	5	I50-2700F	I50-2701F	V50-2704F	I50-2710F	I50-2711F
	10	I50-2700H	I50-2701H	V50-2704H	I50-2710H	I50-2711H
	15	I50-2700J	I50-2701J	V50-2704J	I50-2710J	I50-2711J
	30	I50-2700L			I50-2710L	I50-2711L
1500	5	I50-2800F	I50-2801F	V50-2804F	I50-2810F	I50-2811F
	10	I50-2800H	I50-2801H	V50-2804H	I50-2810H	I50-2811H
	15	I50-2800J	I50-2801J	V50-2804J	I50-2810J	I50-2811J
	30	I50-2800L	I50-2801L		I50-2810L	I50-2811L
1600	5	I50-2900F	I50-2901F	V50-2904F	I50-2910F	I50-2911F
	10	I50-2900H	I50-2901H	V50-2904H	I50-2910H	I50-2911H
	15	I50-2900J	I50-2901J	V50-2904J	I50-2910J	I50-2911J
	30	I50-2900L	I50-2901L		I50-2910L	I50-2911L

Primary conductor	130 x 25 mm
Round conductor	Ø 25 mm
Transformer width	180 mm
Snap-on mounting	—
Sealed shutter	—
Current transformer for tariff applications	see page 190



ASK 130.5 Plug-in current transformer

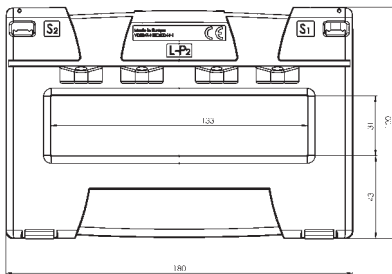
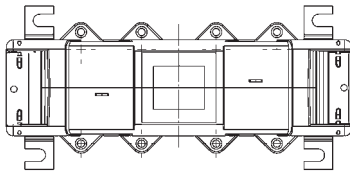
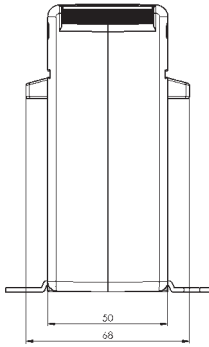

Primary conductor	130 x 30 mm
Round conductor	Ø 30 mm
Transformer width	180 mm
Snap-on mounting	—
Sealed shutter	—
Current transformer for tariff applications	see page 191

Secondary current		5A			1A	
Primary current A	Burden VA	Accuracy class			Accuracy class	
		1	0.5	0.2s	1	0.5
		Art.-no.	Art.-no.	Art.-no.	Art.-no.	Art.-no.
300	2.5	I51-1900D	I51-1901D		I51-1910D	I51-1911D
	5	I51-1900F	I51-1901F		I51-1910F	I51-1911F
	10	I51-1900H	I51-1901H		I51-1910H	I51-1911H
400	2.5	I51-2000D	I51-2001D		I51-2010D	I51-2011D
	5	I51-2000F	I51-2001F		I51-2010F	I51-2011F
	10	I51-2000H	I51-2001H		I51-2010H	I51-2011H
500	2.5	I51-2100D	I51-2101D		I51-2110D	I51-2111D
	5	I51-2100F	I51-2101F		I51-2110F	I51-2111F
	10	I51-2100H	I51-2101H		I51-2110H	I51-2111H
	15	I51-2100J	I51-2101J		I51-2110J	I51-2111J
600	2.5	I51-2200D	I51-2201D		I51-2210D	I51-2211D
	5	I51-2200F	I51-2201F		I51-2210F	I51-2211F
	10	I51-2200H	I51-2201H		I51-2210H	I51-2211H
	15	I51-2200J	I51-2201J		I51-2210J	I51-2211J
750	2.5	I51-2300D	I51-2301D	V51-2304D	I51-2310D	
	5	I51-2300F	I51-2301F	V51-2304F	I51-2310F	I51-2311F
	10	I51-2300H	I51-2301H		I51-2310H	I51-2311H
	15	I51-2300J	I51-2301J		I51-2310J	I51-2311J
1000	5	I51-2500F	I51-2501F	V51-2504F	I51-2510F	I51-2511F
	10	I51-2500H	I51-2501H	V51-2504H	I51-2510H	I51-2511H
	15	I51-2500J	I51-2501J		I51-2510J	I51-2511J
	30	I51-2500L	I51-2501L		I51-2510L	I51-2511L
1200	5	I51-2600F	I51-2601F	V51-2604F	I51-2610F	I51-2611F
	10	I51-2600H	I51-2601H	V51-2604H	I51-2610H	I51-2611H
	15	I51-2600J	I51-2601J	V51-2604J	I51-2610J	I51-2611J
	30	I51-2600L	I51-2601L		I51-2610L	I51-2611L
1250	5	I51-2700F	I51-2701F	V51-2704F	I51-2710F	I51-2711F
	10	I51-2700H	I51-2701H	V51-2704H	I51-2710H	I51-2711H
	15	I51-2700J	I51-2701J	V51-2704J	I51-2710J	I51-2711J
	30	I51-2700L	I51-2701L		I51-2710L	I51-2711L
	45	I51-2700M				
1500	5	I51-2800F	I51-2801F	V51-2804F	I51-2810F	I51-2811F
	10	I51-2800H	I51-2801H	V51-2804H	I51-2810H	I51-2811H
	15	I51-2800J	I51-2801J	V51-2804J	I51-2810J	I51-2811J
	30	I51-2800L	I51-2801L		I51-2810L	I51-2811L
	45	I51-2800M				
1600	5	I51-2900F	I51-2901F	V51-2904F	I51-2910F	I51-2911F
	10	I51-2900H	I51-2901H	V51-2904H	I51-2910H	I51-2911H
	15	I51-2900J	I51-2901J	V51-2904J	I51-2910J	I51-2911J
	30	I51-2900L	I51-2901L		I51-2910L	I51-2911L
	45	I51-2900M				
2000	10	I51-3000H	I51-3001H	V51-3004H	I51-3010H	I51-3011H
	15	I51-3000J	I51-3001J	V51-3004J	I51-3010J	I51-3011J
	30	I51-3000L	I51-3001L		I51-3010L	I51-3011L
	45	I51-3000M	I51-3001M			
2400	10	I51-3100H	I51-3101H	V51-3104H	I51-3110H	I51-3111H
	15	I51-3100J	I51-3101J	V51-3104J	I51-3110J	I51-3111J
	30	I51-3100L	I51-3101L		I51-3110L	I51-3111L
	45	I51-3100M	I51-3101M			
2500	10	I51-3200H	I51-3201H	V51-3204H	I51-3210H	I51-3211H
	15	I51-3200J	I51-3201J	V51-3204J	I51-3210J	I51-3211J
	30	I51-3200L	I51-3201L	V51-3204L	I51-3210L	I51-3211L
	45	I51-3200M	I51-3201M			
3000	10	I51-3300H	I51-3301H	V51-3304H	I51-3310H	I51-3311H
	15	I51-3300J	I51-3301J	V51-3304J	I51-3310J	I51-3311J
	30	I51-3300L	I51-3301L	V51-3304L	I51-3310L	I51-3311L
	45	I51-3300M				
3200	10	I51-3400H	I51-3401H	V51-3404H	I51-3410H	I51-3411H
	15	I51-3400J	I51-3401J	V51-3404J	I51-3410J	I51-3411J
	30	I51-3400L	I51-3401L	V51-3404L	I51-3410L	I51-3411L
	45	I51-3400M			I51-3410M	