



Documentation

EL10xx, EL11xx

Digital Input Terminals

BECKHOFF

1 Product overview EtherCAT digital input terminals

[EL1002, EL1004, EL1008 \[► 12\]](#) (2, 4, 8 channels; 24 V_{DC}, 3 ms input filter)

[EL1012, EL1014, EL1018 \[► 17\]](#) (2, 4, 8 channels; 24 V_{DC}, 10 µs input filter)

[EL1024 \[► 22\]](#) (4 channels; 24 V_{DC}, 3 ms input filter for type 2 sensors)

[EL1034 \[► 22\]](#) (4 channels; 24 V_{DC}, 10 µs input filter, potential-free)

[EL1084, EL1088 \[► 25\]](#) (4, 8 channels; 24 V_{DC}, 3 ms input filter, switching to negative potential)

[EL1094, EL1098 \[► 25\]](#) (4, 8 channels; 24 V_{DC}, 10 µs input filter, switching to negative potential)

[EL1104 \[► 28\]](#) (4 channels; 24 V_{DC}, 3 ms input filter, with sensor supply)

[EL1114 \[► 28\]](#) (4 channels; 24 V_{DC}, 10 µs input filter, with sensor supply)

[EL1124, EL1144, EL1134 \[► 30\]](#) (4 channels; 5/12/48 V_{DC}, 10 µs input filter)

Table of contents

1	Product overview EtherCAT digital input terminals	3
2	Foreword	6
2.1	Notes on the documentation	6
2.2	Safety instructions	7
2.3	Documentation issue status	8
2.4	Version identification of EtherCAT devices	8
3	Product overview	12
3.1	EL1002, EL1004, EL1008 - Introduction	12
3.1.1	EL1002 - LEDs and connection	13
3.1.2	EL1004 - LEDs and connection	14
3.1.3	EL1008 - LEDs and connection	15
3.1.4	EL1002, EL1004, EL1008 - Technical data	16
3.2	EL1012, EL1014, EL1018 - Introduction	17
3.2.1	EL1012 - LEDs and connection	18
3.2.2	EL1014 - LEDs and connection	19
3.2.3	EL1018 - LEDs and connection	20
3.2.4	EL1012, EL1014, EL1018 - Technical data	21
3.3	EL1024, EL1034 - Introduction	22
3.3.1	EL1024 - LEDs and connection	23
3.3.2	EL1034 - LEDs and connection	24
3.3.3	EL1024, EL1034 - Technical data	25
3.4	EL108x, EL109x - Introduction	25
3.4.1	EL1084, EL1094 - LEDs and comment	26
3.4.2	EL1088, EL1098 - LEDs and connection	27
3.4.3	EL1084, EL1088, EL1094, EL1098 - Technical data	28
3.5	EL1104, EL1114 - Introduction	28
3.5.1	EL1104, EL1114 - LEDs and connection	29
3.5.2	EL1104, EL1114 - Technical data	30
3.6	EL1124, EL1144, EL1134 - Introduction	30
3.6.1	EL1124, EL1144, EL1134 - LEDs and connection	31
3.6.2	EL1124, EL1144, EL1134 - Technical data	32
3.7	Application notes	33
4	Basics communication	34
4.1	EtherCAT basics	34
4.2	EtherCAT cabling – wire-bound	34
4.3	General notes for setting the watchdog	35
4.4	EtherCAT State Machine	37
4.5	CoE - Interface: notes	39
4.6	Distributed Clock	40
5	Mounting and wiring	41
5.1	Installation on mounting rails	41
5.2	Installation instructions for enhanced mechanical load capacity	43
5.3	Connection system	44
5.4	Installation positions	47
5.5	Mounting of Passive Terminals	48
5.6	ATEX - Special conditions	50
6	Commissioning	52
6.1	TwinCAT 2.1x	52

6.1.1	Installation of the TwinCAT real-time driver	52
6.1.2	Notes regarding ESI device description.....	56
6.1.3	Offline configuration creation (master: TwinCAT 2.x)	60
6.1.4	Online configuration creation 'scanning' (master: TwinCAT 2.x)	66
6.1.5	EtherCAT slave process data settings.....	75
6.1.6	Configuration with the TwinCAT System Manager - digital input and output terminals	76
6.2	General Notes - EtherCAT Slave Application	81
6.3	Control and Status Byte	89
7	Appendix	90
7.1	EtherCAT AL Status Codes	90
7.2	UL notice.....	90
7.3	ATEX Documentation	92
7.4	Firmware compatibility	92
7.5	Firmware Update EL/ES/EM/EPxxxx.....	92
7.6	Support and Service	102

2 Foreword

2.1 Notes on the documentation

This description is only intended for the use of trained specialists in control and automation engineering who are familiar with the applicable national standards.

It is essential that the following notes and explanations are followed when installing and commissioning these components.

The responsible staff must ensure that the application or use of the products described satisfy all the requirements for safety, including all the relevant laws, regulations, guidelines and standards.

Disclaimer

The documentation has been prepared with care. The products described are, however, constantly under development.

For that reason the documentation is not in every case checked for consistency with performance data, standards or other characteristics.

In the event that it contains technical or editorial errors, we retain the right to make alterations at any time and without warning.

No claims for the modification of products that have already been supplied may be made on the basis of the data, diagrams and descriptions in this documentation.

Trademarks

Beckhoff®, TwinCAT®, EtherCAT®, Safety over EtherCAT®, TwinSAFE®, XFC® and XTS® are registered trademarks of and licensed by Beckhoff Automation GmbH.

Other designations used in this publication may be trademarks whose use by third parties for their own purposes could violate the rights of the owners.

Patent Pending

The EtherCAT Technology is covered, including but not limited to the following patent applications and patents:

EP1590927, EP1789857, DE102004044764, DE102007017835

with corresponding applications or registrations in various other countries.

The TwinCAT Technology is covered, including but not limited to the following patent applications and patents:

EP0851348, US6167425 with corresponding applications or registrations in various other countries.

EtherCAT®

EtherCAT® is registered trademark and patented technology, licensed by Beckhoff Automation GmbH, Germany

Copyright

© Beckhoff Automation GmbH & Co. KG, Germany.

The reproduction, distribution and utilization of this document as well as the communication of its contents to others without express authorization are prohibited.

Offenders will be held liable for the payment of damages. All rights reserved in the event of the grant of a patent, utility model or design.

2.2 Safety instructions

Safety regulations

Please note the following safety instructions and explanations!
Product-specific safety instructions can be found on following pages or in the areas mounting, wiring, commissioning etc.

Exclusion of liability





All the components are supplied in particular hardware and software configurations appropriate for the application. Modifications to hardware or software configurations other than those described in the documentation are not permitted, and nullify the liability of Beckhoff Automation GmbH & Co. KG.

Personnel qualification

This description is only intended for trained specialists in control, automation and drive engineering who are familiar with the applicable national standards.

Description of symbols

In this documentation the following symbols are used with an accompanying safety instruction or note. The safety instructions must be read carefully and followed without fail!

 DANGER	<p>Serious risk of injury! Failure to follow the safety instructions associated with this symbol directly endangers the life and health of persons.</p>
 WARNING	<p>Risk of injury! Failure to follow the safety instructions associated with this symbol endangers the life and health of persons.</p>
 CAUTION	<p>Personal injuries! Failure to follow the safety instructions associated with this symbol can lead to injuries to persons.</p>
 Attention	<p>Damage to the environment or devices Failure to follow the instructions associated with this symbol can lead to damage to the environment or equipment.</p>
 Note	<p>Tip or pointer This symbol indicates information that contributes to better understanding.</p>

2.3 Documentation issue status

Version	Comment
4.1	- Structural update - Correction Chapter "Application notes" - Change Chapter "Configuration with the TwinCAT System Manager" > "Configuration with the TwinCAT System Manager – digital input – and output terminals" - Change chapter "CoE Interface" > "Coe Interface: notes"
4.0	- First publication in PDF format - Structural update
3.3	- "Technical data" section updated - "Assembly instructions with increased mechanical load capacity" section supplemented
3.2	- Technical data supplemented - Structural update
3.1	- Connection diagrams updated
3.0	- Note regarding firmware compatibility added
2.9	- UL requirements added
2.8	- Technical description amended, technical note added
2.7	- Technical description (EL101x, EL1114) amended
2.6	- Technical description (EL1024, EL1034) amended
2.5	- Technical description amended
2.4	- Technical data amended (EL1124)
2.3	- Technical data amended
2.2	- Technical data amended
2.1	- Terminals EL1124, EL1144, EL1034 added, technical data amended
2.0	- Terminals EL1002, EL1008, EL1018, EL1084, EL1088, EL1094, EL1098, EL1104, EL1114 added, technical data amended
1.0	- Technical data amended
0.1	- Provisional documentation for EL10xx

2.4 Version identification of EtherCAT devices

Designation

A Beckhoff EtherCAT device has a 14-digit designation, made up of

- family key
- type
- version
- revision

Example	Family	Type	Version	Revision
EL3314-0000-0016	EL terminal (12 mm, non-pluggable connection level)	3314 (4-channel thermocouple terminal)	0000 (basic type)	0016
CU2008-0000-0000	CU device	2008 (8-port fast ethernet switch)	0000 (basic type)	0000
ES3602-0010-0017	ES terminal (12 mm, pluggable connection level)	3602 (2-channel voltage measurement)	0010 (high-precision version)	0017

Notes

- the elements named above make up the **technical designation**
- The **order designation**, conversely, is made up of
 - family key (EL, EP, CU, ES, KL, CX, etc.)
 - type
 - version
- The **revision** shows the technical progress, such as the extension of features with regard to the EtherCAT communication, and is managed by Beckhoff.
In principle, a device with a higher revision can replace a device with a lower revision, unless specified otherwise, e.g. in the documentation.
Associated and synonymous with each revision there is usually a description (ESI, EtherCAT Slave Information) in the form of an XML file, which is available for download from the Beckhoff website.
The revision has been applied to the IP20 terminals on the outside since 2014/01, see fig. 1.
- The type, version and revision are read as decimal numbers, even if they are technically saved in hexadecimal.

Identification number

Beckhoff EtherCAT devices from the different lines have different kinds of identification numbers:

Production lot/batch number/serial number/date code/D number

Serial number is the name generally given to the 8-digit number that is printed on the device or attached to it on a sticker. This serial number indicates the as-built status on delivery and thus ambiguously marks a whole production lot.

Structure of the serial number: **KK YY FF HH**

KK - week of production (CW, calendar week)

YY - year of production

FF - firmware version

HH - hardware version

Example with ser. no.: 12063A02: 12 - production week 12 06 - production year 2006 3A - firmware version 3A 02 - hardware version 02

Exceptions can occur in the **IP67 area**, where the following syntax can be used (see respective device documentation):

Syntax: D ww yy x y z u

D - prefix designation

ww - calendar week

yy - year

x - firmware version of the bus PCB

y - hardware version of the bus PCB

z - firmware version of the I/O PCB

u - hardware version of the I/O PCB

Example: D.22081501 calendar week 22 of the year 2008 firmware version of bus PCB: 1 hardware version of bus PCB: 5 firmware version of I/O PCB: 0 (no firmware necessary for this PCB) hardware version of I/O PCB: 1

Unique serial number/ID

Beyond that there are some series in which each individual module has its own unique, sequential serial number.

See also the further documentation in the area

- [IP67: EtherCAT Box](#)
- [Safety: TwinSafe](#)

Examples of markings:

Fig. 1: EL5021 EL terminal, standard IP20 IO device with batch number and revision ID (since 2014/01)



Fig. 2: EK1100 EtherCAT coupler, standard IP20 IO device with batch number

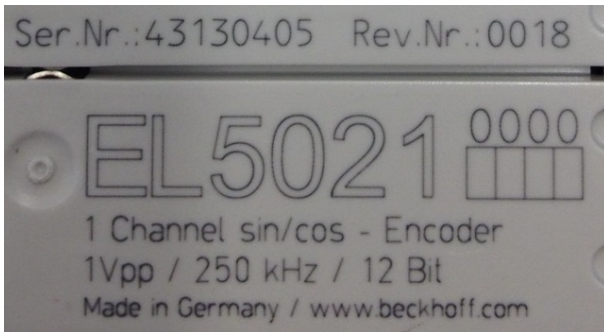

Fig. 3: CU2016 switch with batch number

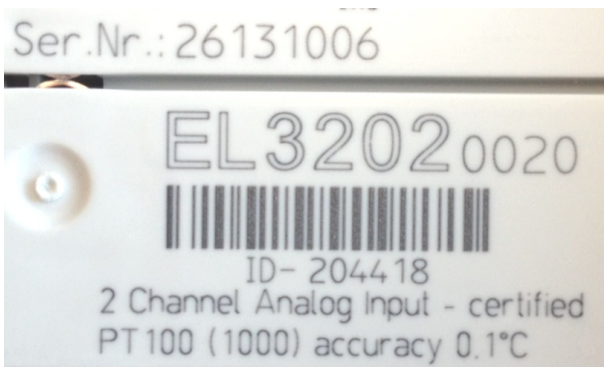

Fig. 4: EL3202-0020 with batch numbers 26131006 and unique D-number 204418

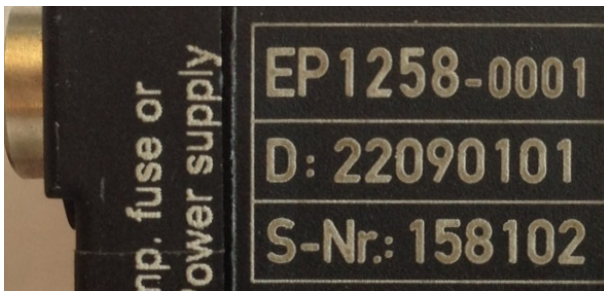

Fig. 5: EP1258-00001 IP67 EtherCAT Box with batch number 22090101 and serial number 158102

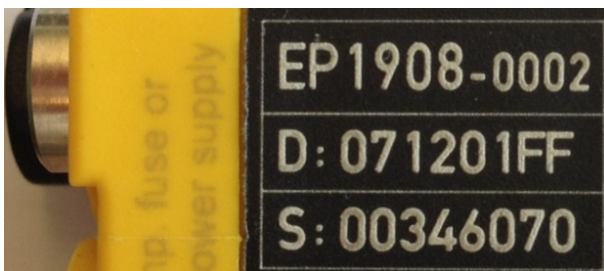

Fig. 6: EP1908-0002 IP76 EtherCAT Safety Box with batch number 071201FF and serial number 00346070

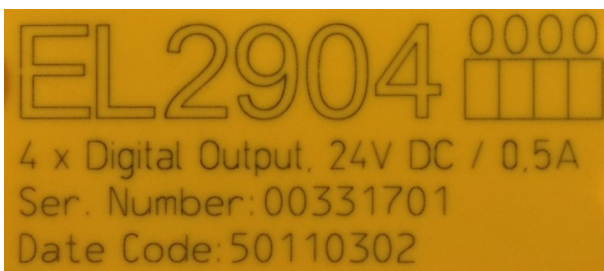

Fig. 7: EL2904 IP20 safety terminal with batch number/date code 50110302 and serial number 00331701

3 Product overview

3.1 EL1002, EL1004, EL1008 - Introduction

Two-, four- and eight-channel digital input terminals 24 V_{DC}, 3 ms input filter

The EL1002, EL1004 and EL1008 digital input terminals acquire binary control signals from the process level and transmit them, in an electrically isolated form, to the higher-level automation device. They differ in the number of channels and the pin assignment. The digital input terminals of the EL100x series feature an input filter (3 ms) and indicate their signal state through an LED for each channel.

3.1.1 EL1002 - LEDs and connection

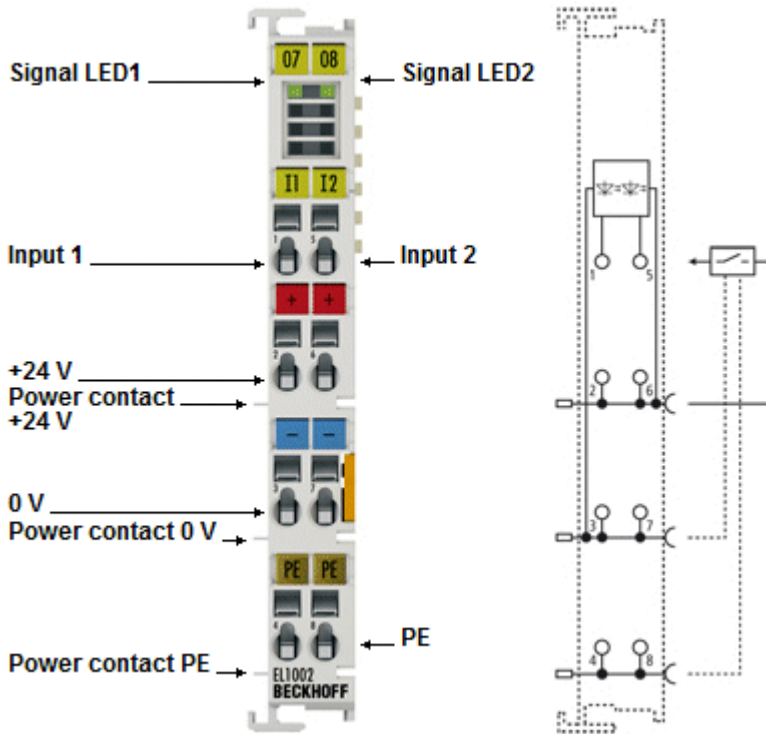

Fig. 8: EL1002

EL1002 – LEDs

LED	Color	Meaning
INPUT 1	green	off
INPUT 2		on
		Signal voltage "0" (-3 V ... 5 V)
		Signal voltage "1" (15 V ... 30 V)

EL1002 – Connection

Terminal point		Description
Name	No.	
Input 1	1	Input 1
+24 V	2	Sensor supply for input 1 (internally connected to terminal point 6 and positive power contact)
0 V	3	Ground for input 1 (internally connected to terminal point 7 and negative power contact)
PE	4	PE (internally connected to terminal point 8)
Input 2	5	Input 2
+24 V	6	Sensor supply for input 2 (internally connected to terminal point 2 and positive power contact)
0 V	7	Ground for input 2 (internally connected to terminal point 3 and negative power contact)
PE	8	PE (internally connected to terminal point 4)

3.1.2 EL1004 - LEDs and connection

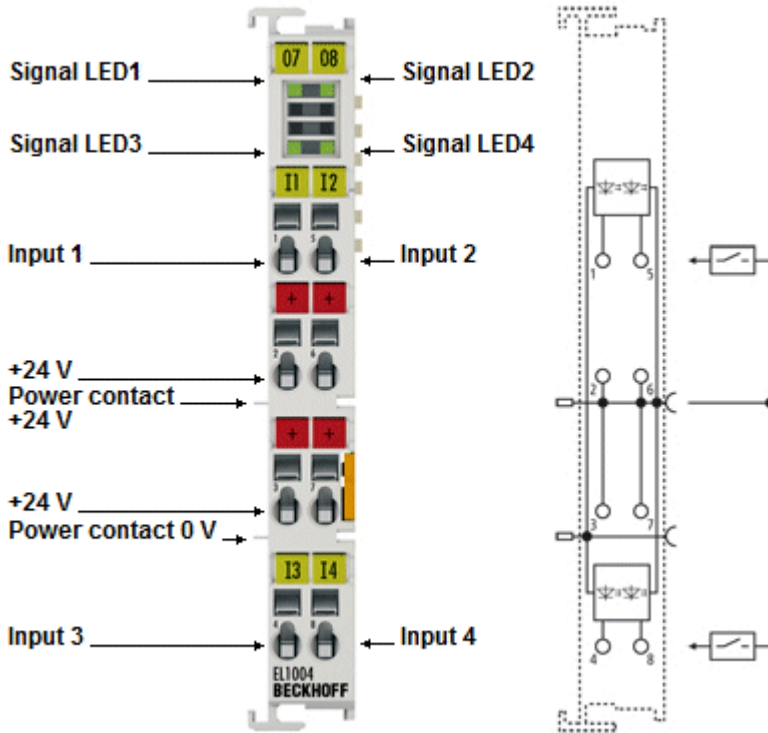

Fig. 9: EL1004

EL1004 - LEDs

LED	Colour	Meaning	
INPUT 1- 4	green	off	Signal voltage "0" (-3 V ... 5 V)
		on	Signal voltage "1" (15 V ... 30 V)

EL1004 - Connection

Terminal point		Description
Name	No.	
Input 1	1	Input 1
+24 V	2	Sensor supply for input 1 (internally connected to terminal points 3, 6, 7 and positive power contact)
+24 V	3	Sensor supply for input 3 (internally connected to terminal points 2, 6, 7 and positive power contact)
Input 3	4	Input 3
Input 2	5	Input 2
+24 V	6	Sensor supply for input 2 (internally connected to terminal points 2, 3, 7 and positive power contact)
+24 V	7	Sensor supply for input 4 (internally connected to terminal points 2, 3, 6 and positive power contact)
Input 4	8	Input 4

3.1.3 EL1008 - LEDs and connection

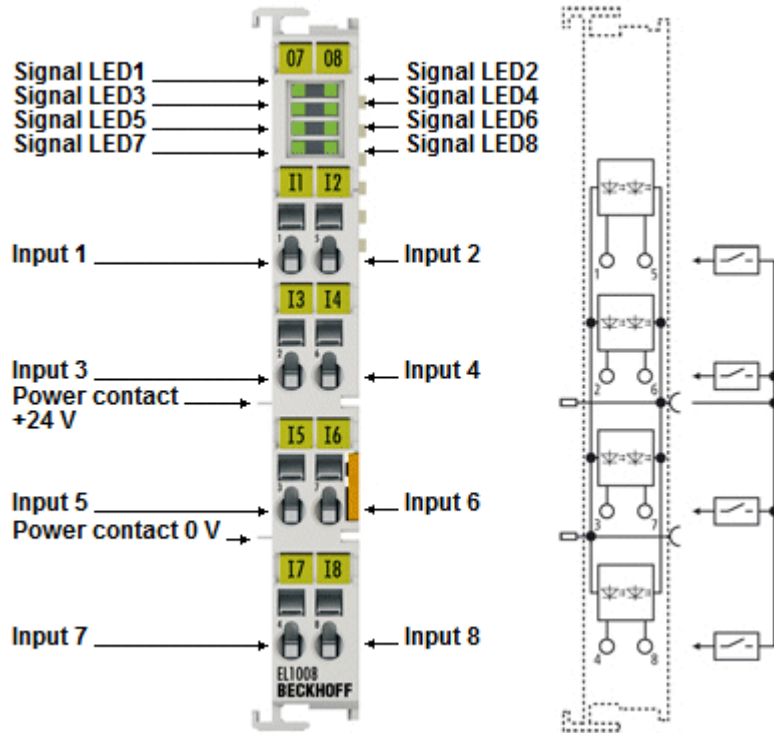

Fig. 10: EL1008

EL1008 - LEDs

LED	Colour	Meaning	
INPUT 1- 8	green	off	Signal voltage "0" (-3 V ... 5 V)
		on	Signal voltage "1" (15 V ... 30 V)

EL1008 - Connection

Terminal point		Description
Name	No.	
Input 1	1	Input 1
Input 3	2	Input 3
Input 5	3	Input 5
Input 7	4	Input 7
Input 2	5	Input 2
Input 4	6	Input 4
Input 6	7	Input 6
Input 8	8	Input 8

3.1.4 EL1002, EL1004, EL1008 - Technical data

Technical data	EL1002	EL1004	EL1008
Number of inputs	2	4	8
Number of simultaneously controllable inputs, depending on the ambient temperature	2 (> +55°C)	4 (-25°C ... +55°C) 2 (> +55°C)	8 (-25°C ... +55°C) 4 (> +55°C) (aligned in horizontal installation position) ▶ 47]
Nominal voltage of the inputs	24 V _{DC} (-15% / +20%)		
Signal voltage "0"	-3 V ... 5 V (EN 61131-2, type 1)		
Signal voltage "1"	15 V ... 30 V (EN 61131-2, type 1)		
Input filter	3 ms		
Input current	typically 3 mA (EN 61131-2, type 1)		
Supply voltage for internal E-bus circuit	via power contacts		
Current consumption via E-bus	typ. 90 mA		
Electrical isolation	500 V (E-bus/field voltage)		
Bit width in the process image	2 input bits	4 input bits	8 input bits
Configuration	no address setting, configuration via TwinCAT System Manager		
Weight	approx. 55 g		
Permissible ambient temperature range during operation	-25°C ... +60°C (extended temperature range)		-25°C ... +60°C (extended temperature range, aligned in horizontal installation position ▶ 47])
	0°C ... +55°C (in accordance with cULus ▶ 90] for Canada and the USA)		0°C ... +55°C (according to cULus ▶ 90] for Canada and USA, aligned in horizontal installation position ▶ 47])
	0°C ... +55°C (according to ATEX ▶ 50], see special conditions ▶ 50])		0°C ... +55°C (according to ATEX ▶ 50], see special conditions ▶ 50], aligned in horizontal installation position ▶ 47])
Permissible ambient temperature range during storage	-40°C ... +85°C		
Permissible relative humidity	95%, no condensation		
Dimensions (W x H x D)	approx. 15 mm x 100 mm x 70 mm (width aligned: 12 mm)		
Mounting ▶ 41]	on 35 mm mounting rail conforms to EN 60715		
Vibration/shock resistance	according to EN 60068-2-6/EN 60068-2-27, see also Installation instructions for terminals with increased mechanical load capacity ▶ 43]		
EMC resistance burst/ESD	conforms to EN 61000-6-2 / EN 61000-6-4		
Protection class	IP 20		
Installation position	variable	variable	see note ▶ 47]
Approval	CE, cULus ▶ 90], ATEX ▶ 50]		

3.2 EL1012, EL1014, EL1018 - Introduction

Two-, four- and eight-channel digital input terminals 24 V_{DC}, 10 μs input filter

The EL101x digital input terminals acquire binary control signals from the process level and transmit them, in an electrically isolated form, to the higher-level automation device. They differ in the number of channels and the pin assignment. The digital input terminals of the EL101x series feature an input filter (10 ms) and indicate their signal state through an LED for each channel.

3.2.1 EL1012 - LEDs and connection

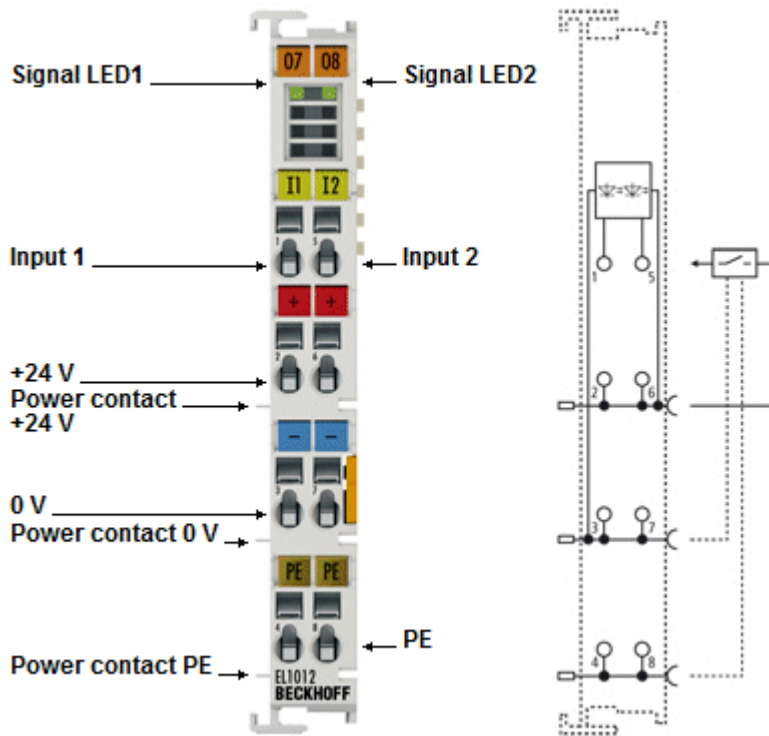

Fig. 11: EL1012

EL1012 – LEDs

LED	Color	Meaning
INPUT 1	green	off
INPUT 2		on
		Signal voltage "0" (-3 V ... 5 V)
		Signal voltage "1" (15 V ... 30 V)

EL1012 – Connection

Terminal point		Description
Name	No.	
Input 1	1	Input 1
+24 V	2	Sensor supply for input 1 (internally connected to terminal point 6 and positive power contact)
0 V	3	Ground for input 1 (internally connected to terminal point 7 and negative power contact)
PE	4	PE (internally connected to terminal point 8)
Input 2	5	Input 2
+24 V	6	Sensor supply for input 2 (internally connected to terminal point 2 and positive power contact)
0 V	7	Ground for input 2 (internally connected to terminal point 3 and negative power contact)
PE	8	PE (internally connected to terminal point 4)

3.2.2 EL1014 - LEDs and connection

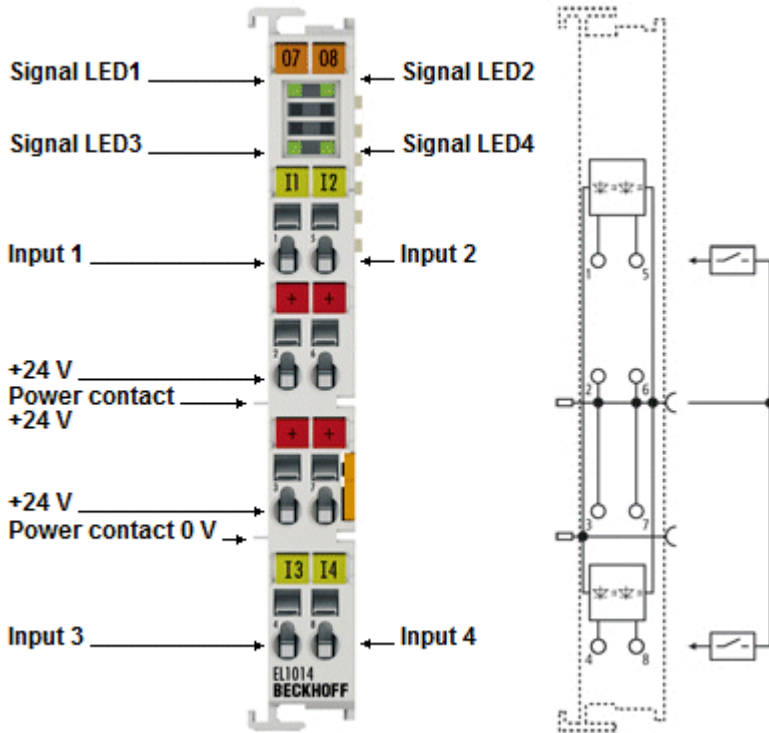

Fig. 12: EL1014

EL1014 - LEDs

LED	Color	Meaning	
INPUT 1- 4	green	off	Signal voltage "0" (-3 V ... 5 V)
		on	Signal voltage "1" (15 V ... 30 V)

EL1014 - Connection

Terminal point		Description
Name	No.	
Input 1	1	Input 1
+24 V	2	Sensor supply for input 1 (internally connected to terminal points 3, 6, 7 and positive power contact)
+24 V	3	Sensor supply for input 3 (internally connected to terminal points 2, 6, 7 and positive power contact)
Input 3	4	Input 3
Input 2	5	Input 2
+24 V	6	Sensor supply for input 2 (internally connected to terminal points 2, 3, 7 and positive power contact)
+24 V	7	Sensor supply for input 4 (internally connected to terminal points 2, 3, 6 and positive power contact)
Input 4	8	Input 4

3.2.3 EL1018 - LEDs and connection

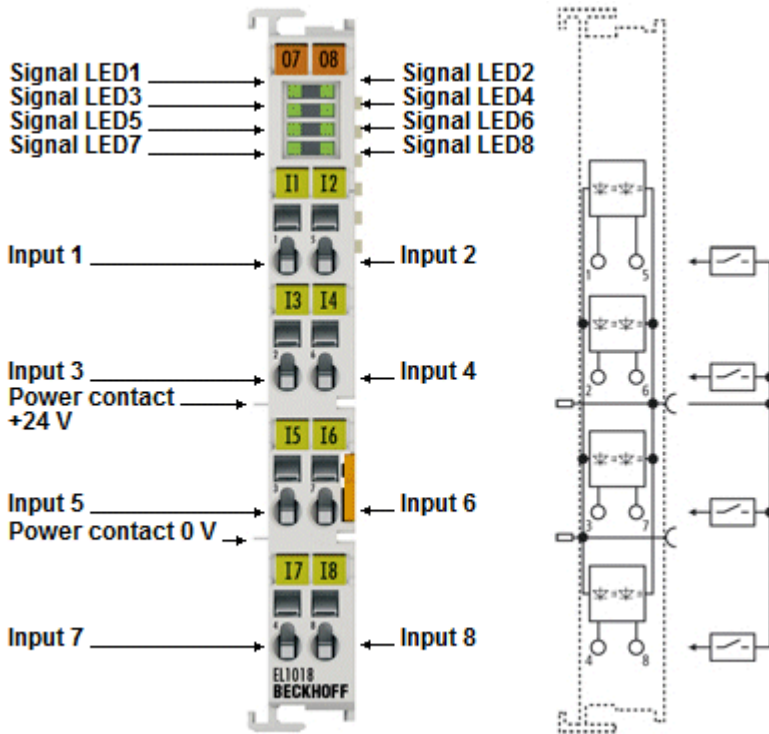

Fig. 13: EL1018

EL1018 - LEDs

LED	Color	Meaning	
INPUT 1- 8	green	off	Signal voltage "0" (-3 V ... 5 V)
		on	Signal voltage "1" (15 V ... 30 V)

EL1018 - Connection

Terminal point		Description
Name	No.	
Input 1	1	Input 1
Input 3	2	Input 3
Input 5	3	Input 5
Input 7	4	Input 7
Input 2	5	Input 2
Input 4	6	Input 4
Input 6	7	Input 6
Input 8	8	Input 8

3.2.4 EL1012, EL1014, EL1018 - Technical data

Technical data	EL1012	EL1014	EL1018
Number of inputs	2	4	8
Number of simultaneously controllable inputs, depending on the ambient temperature	2 (> +55°C)	4 (-25°C ... +55°C) 2 (> +55°C)	8 (-25°C ... +55°C) 4 (> +55°C) (aligned in <u>horizontal installation position</u>) [▶ 47]
Nominal voltage of the inputs	24 V _{DC} (-15% / +20%)		
Signal voltage "0"	-3 V ... 5 V (EN 61131-2, type 1)		
Signal voltage "1"	15 V ... 30 V (EN 61131-2, type 1)		
Input filter	10 µs typ. (10...50 µs)		
Input current	typically 3 mA (EN 61131-2, type 1)		
Supply voltage for internal E-bus circuit	via power contacts		
Current consumption via E-bus	typ. 90 mA	typ. 90 mA	typ. 90 mA
Electrical isolation	500 V (E-bus/field voltage)		
Bit width in the process image	2 input bits	4 input bits	8 input bits
Configuration	no address setting, configuration via TwinCAT System Manager		
Weight	approx. 55 g		
Permissible ambient temperature range during operation	-25°C ... +60°C (extended temperature range)		-25°C ... +60°C (extended temperature range, aligned in <u>horizontal installation position</u> [▶ 47])
	0°C ... +55°C (in accordance with <u>cULus</u> [▶ 90] for Canada and the USA)		0°C ... +55°C (according to <u>cULus</u> [▶ 90] for Canada and USA, aligned in <u>horizontal installation position</u> [▶ 47])
	0°C ... +55°C (according to <u>ATEX</u> [▶ 50], see <u>special conditions</u> [▶ 50])		0°C ... +55°C (according to <u>ATEX</u> [▶ 50], see <u>special conditions</u> [▶ 50], aligned in <u>horizontal installation position</u> [▶ 47])
Permissible ambient temperature range during storage	-40°C ... +85°C		
Permissible relative humidity	95%, no condensation		
Dimensions (W x H x D)	approx. 15 mm x 100 mm x 70 mm (width aligned: 12 mm)		
<u>Mounting</u> [▶ 41]	on 35 mm mounting rail conforms to EN 60715		
Vibration/shock resistance	according to EN 60068-2-6/EN 60068-2-27, see also <u>Installation instructions for terminals with increased mechanical load capacity</u> [▶ 43]		
EMC resistance burst/ ESD	conforms to EN 61000-6-2 / EN 61000-6-4		
Protection class	IP 20		
Installation position	variable	variable	see <u>note</u> [▶ 47]
Approval	CE, <u>cULus</u> [▶ 90], <u>ATEX</u> [▶ 50]		

3.3 EL1024, EL1034 - Introduction

EL1024 - four-channel digital input terminals 24 V_{DC}, for type 2 sensors

EL1034 - four-channel digital input terminals 24 V_{DC}, potential-free inputs

The EL1024 digital input terminal acquires the binary 24 V control signals and transmits them, in an electrically isolated form, to the higher-level automation system. The EtherCAT Terminal contains four channels that indicate its signal state by means of light emitting diodes. With its input signal the EL1024 corresponds to IEC 61131-2, Type 2. Additionally, the 4-channel EtherCAT Terminals enable the direct connection of four 2-wire sensors. Four +24 V connection points are provided.

The EL1034 features electrical isolation of the individual channels. With its input signal it corresponds to IEC 61131-2, Type 1.

3.3.1 EL1024 - LEDs and connection

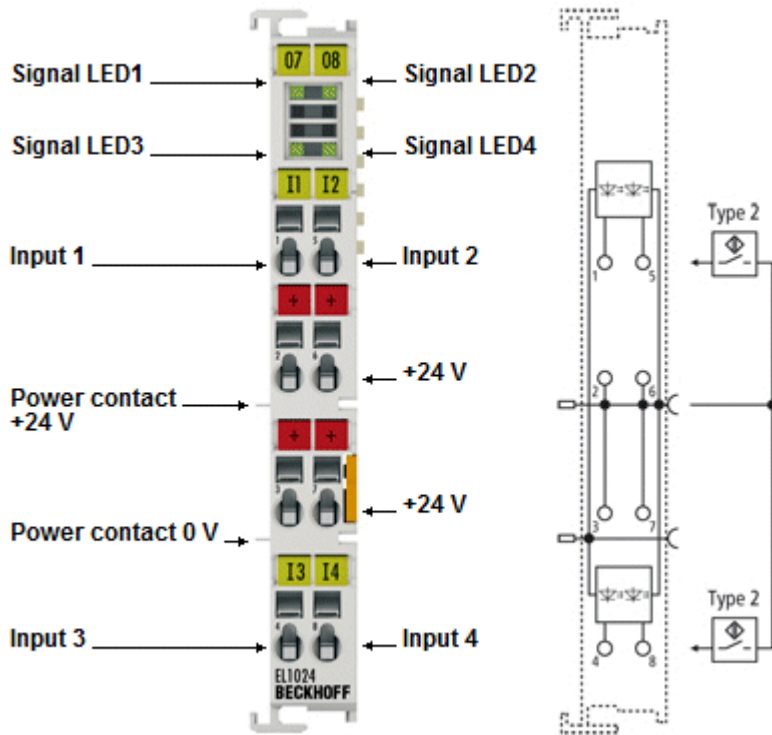

Fig. 14: EL1024

EL1024 - LEDs

LED	Color	Meaning	
INPUT 1- 4	green	off	Signal voltage "0" (-3 V ... 5 V)
		on	Signal voltage "1" (15 V ... 30 V)

EL1024 - Connection

Terminal point		Description
Name	No.	
Input 1	1	Input 1
+24 V	2	Sensor supply for input 1 (internally connected to terminal points 3, 6, 7 and positive power contact)
+24 V	3	Sensor supply for input 3 (internally connected to terminal points 2, 6, 7 and positive power contact)
Input 3	4	Input 3
Input 2	5	Input 2
+24 V	6	Sensor supply for input 2 (internally connected to terminal points 2, 3, 7 and positive power contact)
+24 V	7	Sensor supply for input 4 (internally connected to terminal points 2, 3, 6 and positive power contact)
Input 4	8	Input 4

3.3.2 EL1034 - LEDs and connection

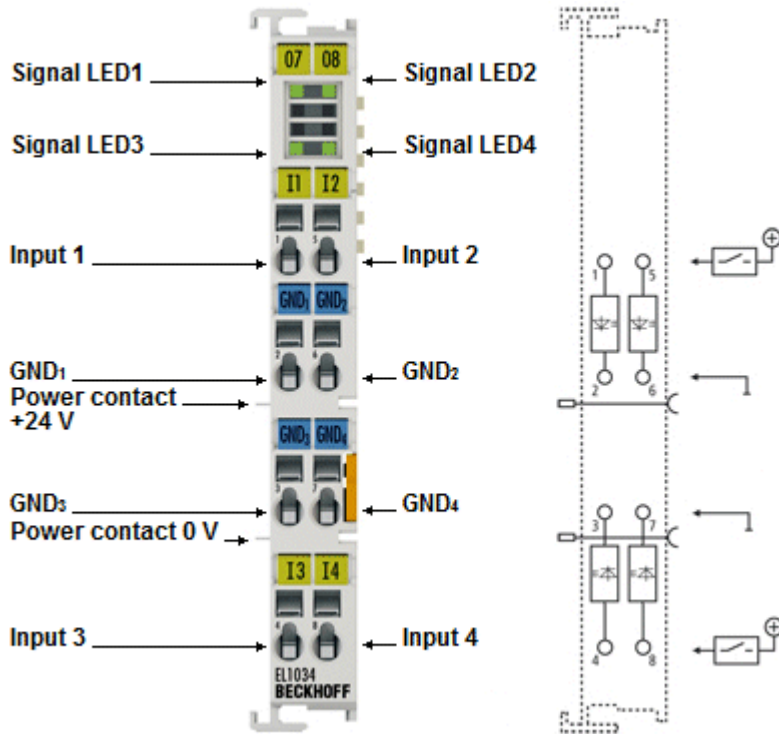

Fig. 15: EL1034

EL1034 - LEDs

LED	Color	Meaning	
INPUT 1- 4	green	off	Signal voltage "0" (-3 V ... 5 V)
		on	Signal voltage "1" (15 V ... 30 V)

EL1034 - Connection

Terminal point		Description
Name	No.	
Input 1	1	Input 1
GND 1	2	Ground (GND) 1
GND 3	3	Ground (GND) 3
Input 3	4	Input 3
Input 2	5	Input 2
GND 2	6	Ground (GND) 2
GND 4	7	Ground (GND) 4
Input 4	8	Input 4

3.3.3 EL1024, EL1034 - Technical data

Technical data	EL1024	EL1034
Number of inputs	4	4 (potential-free)
Nominal voltage of the inputs	24 V _{DC} (-15% / +20%)	
Signal voltage "0"	-3 V ... 5 V (EN 61131-2, type 2)	-3 V ... 5 V (EN 61131-2, type 1)
Signal voltage "1"	15 V ... 30 V (EN 61131-2, type 2)	15 V ... 30 V (EN 61131-2, type 1)
Input filter	3 ms	10 μs
Input current	typically 6 mA (EN 61131-2, type 2)	typically 3 mA (EN 61131-2, type 1)
Supply voltage for internal E-bus circuit	via E-Bus	
Current consumption via E-bus	typ. 90 mA	
Electrical isolation	500 V (E-bus/field voltage)	
Bit width in the process image	4 input bits	
Configuration	no address setting, configuration via TwinCAT System Manager	
Weight	approx. 55 g	
Permissible ambient temperature range during operation	0°C ... + 55°C	
Permissible ambient temperature range during storage	-25°C ... + 85°C	
Permissible relative humidity	95%, no condensation	
Dimensions (W x H x D)	approx. 15 mm x 100 mm x 70 mm (width aligned: 12 mm)	
Mounting ▶ 41	on 35 mm mounting rail conforms to EN 60715	
Vibration/shock resistance	conforms to EN 60068-2-6 / EN 60068-2-27	
EMC resistance burst/ESD	conforms to EN 61000-6-2 / EN 61000-6-4	
Protection class	IP 20	
Installation position	variable	
Approval	CE cULus ▶ 90 ATEX ▶ 50	

3.4 EL108x, EL109x - Introduction

Four- and eight-channel digital input terminals 24 V_{DC}, switching to negative potential

The EL108x and EL109x digital input terminals acquire the binary control signals from the process level and transmit them, in an electrically isolated form, to the higher-level automation device. The EL108x and EL109x versions have input filters of different speeds. Four 2-wire sensors can be connected to the EL1084 and EL1094 EtherCAT Terminals. The EL1088 and EL1098 8-channel terminals are suitable for multi-channel sensors with single-wire connections. The EtherCAT Terminals indicate their signal state by means of light emitting diodes.

3.4.1 EL1084, EL1094 - LEDs and comment

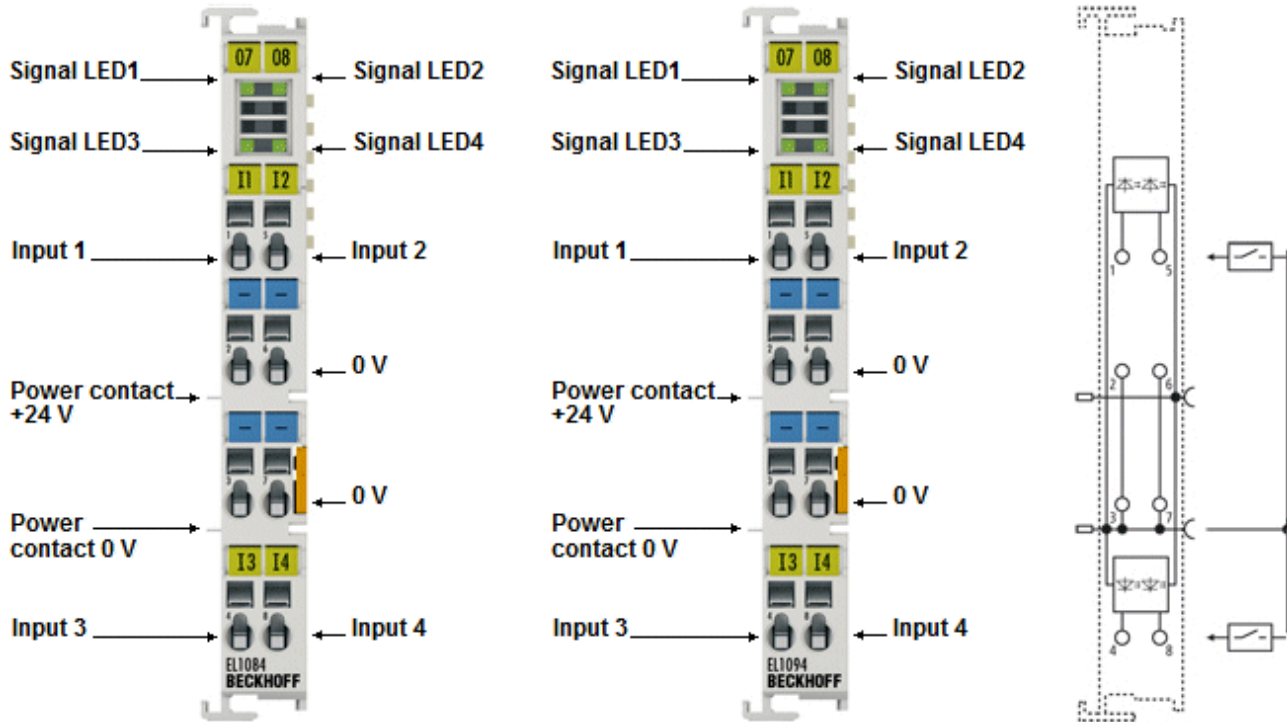

Fig. 16: EL1084, EL1094

EL1084, EL1094 - LEDs

LED	Color	Meaning	
INPUT 1- 4	green	off	Signal voltage "0" (18 V ... 30 V)
		on	Signal voltage "1" (0 V ... 7 V)

EL1084, EL1094 - Connection

Terminal point		Description
Name	No.	
Input 1	1	Input 1
0 V	2	0 V (internally connected to terminal point 3, 6, 7 and negative power contact)
0 V	3	0 V (internally connected to terminal point 2, 6, 7 and negative power contact)
Input 3	4	Input 3
Input 2	5	Input 2
0V	6	0 V (internally connected to terminal point 2, 3, 7 and negative power contact)
0V	7	0 V (internally connected to terminal point 2, 3, 6 and negative power contact)
Input 4	8	Input 4

3.4.2 EL1088, EL1098 - LEDs and connection

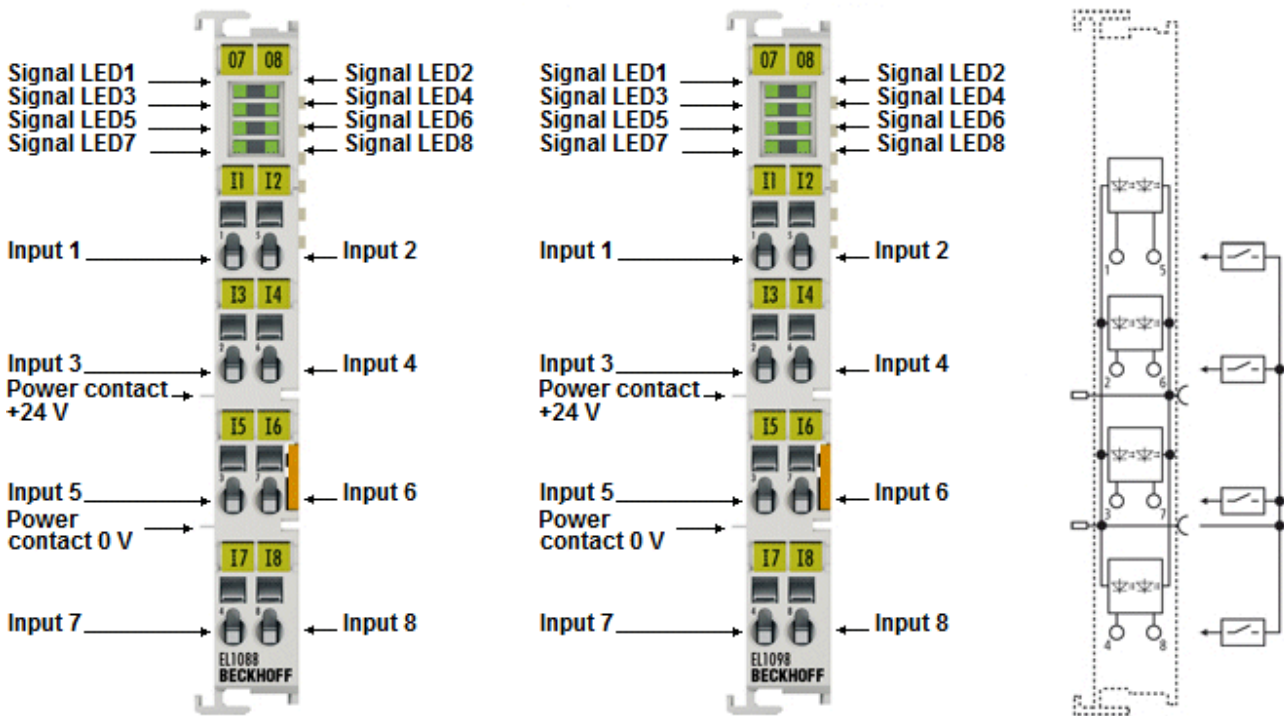

Fig. 17: EL1088, EL1098

EL1088, EL1098 - LEDs

LED	Color	Meaning	
INPUT 1- 8	green	off	Signal voltage "0" (18 V ... 30 V)
		on	Signal voltage "1" (0 V ... 7 V)

EL1088, EL1098 - Connection

Terminal point		Description
Name	No.	
Input 1	1	Input 1
Input 3	2	Input 3
Input 5	3	Input 5
Input 7	4	Input 7
Input 2	5	Input 2
Input 4	6	Input 4
Input 6	7	Input 6
Input 8	8	Input 8

3.4.3 EL1084, EL1088, EL1094, EL1098 - Technical data

Technical data	EL1084	EL1088	EL1094	EL1098
Number of inputs	4	8	4	8
Nominal voltage of the inputs	24 V _{DC} (-15% / +20%)			
Signal voltage "0"	18 V ... 30 V			
Signal voltage "1"	0 V ... 7 V			
Input filter	3 ms	3 ms	10 µs	10 µs
Input current	typ. 3 mA			
Supply voltage for internal E-bus circuit	via E-Bus			
Current consumption via E-bus	typ. 90 mA			
Electrical isolation	500 V (E-bus/field voltage)			
Bit width in the process image	4 input bits	8 input bits	4 input bits	8 input bits
Configuration	no address setting, configuration via TwinCAT System Manager			
Weight	approx. 55 g			
Permissible ambient temperature range during operation	0°C ... + 55°C	0°C ... + 55°C (aligned in horizontal installation position) 0°C ... + 45°C (all other installation positions, see Note [▶ 47])	0°C ... + 55°C	0°C ... + 55°C (aligned in horizontal installation position) 0°C ... + 45°C (all other installation positions, see Note [▶ 47])
Permissible ambient temperature range during storage	-25°C ... + 85°C			
Permissible relative humidity	95%, no condensation			
Dimensions (W x H x D)	approx. 15 mm x 100 mm x 70 mm (width aligned: 12 mm)			
Mounting [▶ 41]	on 35 mm mounting rail conforms to EN 60715			
Vibration/shock resistance	conforms to EN 60068-2-6 / EN 60068-2-27			
EMC resistance burst/ESD	conforms to EN 61000-6-2 / EN 61000-6-4			
Protection class	IP 20			
Installation position	variable	see note [▶ 47]	variable	see note [▶ 47]
Approval	CE, cULus [▶ 90], ATEX [▶ 50]			

3.5 EL1104, EL1114 - Introduction

Four-channel digital input terminals 24 V_{DC} with sensor supply

The EL1104 and EL1114 digital input terminals acquire the binary control signals from the process level and transmit them, in an electrically isolated form, to the higher-level automation unit. The EL1104 and EL1114 versions have input filters of different speeds. The EtherCAT Terminals contain four channels that indicate their signal state by means of light emitting diodes.

3.5.1 EL1104, EL1114 - LEDs and connection

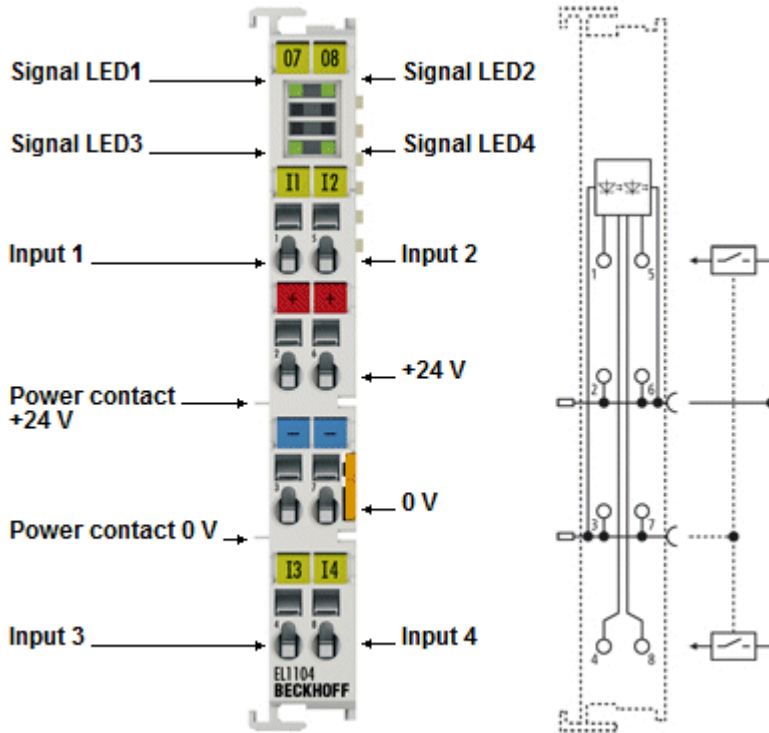

Fig. 18: EL1104

EL1104, EL1114 - LEDs

LED	Color	Meaning	
INPUT 1- 4	green	off	Signal voltage "0" (-3 V ... 5 V)
		on	Signal voltage "1" (15 V ... 30 V)

EL1104, EL1114 - Connection

Terminal point		Description
Name	No.	
Input 1	1	Input 1
+24 V	2	Sensor supply +24 V (internally connected to terminal point 6 and positive power contact)
0 V	3	Sensor supply 0 V (internally connected to terminal point 7 and negative power contact)
Input 3	4	Input 3
Input 2	5	Input 2
+24 V	6	Sensor supply +24 V (internally connected to terminal point 2 and positive power contact)
0 V	7	Sensor supply 0 V (internally connected to terminal point 3 and negative power contact)
Input 4	8	Input 4

3.5.2 EL1104, EL1114 - Technical data

Technical data	EL1104	EL1114
Number of inputs	4	
Nominal voltage of the inputs	24 V _{DC} (-15% / +20%)	
Signal voltage "0"	-3 V ... 5 V	
Signal voltage "1"	15 V ... 30 V	
Input filter	3 ms	10 μs typ. (10...50 μs)
Input current	typ. 3 mA	
Supply voltage for internal E-bus circuit	via power contacts	
Current consumption from the E-bus	typ. 90 mA	
Electrical isolation	500 V (E-bus/field voltage)	
Bit width in the process image	4 input bits	
Configuration	no address setting, configuration via TwinCAT System Manager	
Weight	approx. 55 g	
Permissible ambient temperature range during operation	0°C ... + 55°C	
Permissible ambient temperature range during storage	-25°C ... + 85°C	
Permissible relative humidity	95%, no condensation	
Dimensions (W x H x D)	approx. 15 mm x 100 mm x 70 mm (width aligned: 12 mm)	
Mounting ▶ 41	on 35 mm mounting rail conforms to EN 60715	
Vibration/shock resistance	conforms to EN 60068-2-6 / EN 60068-2-27	
EMC resistance burst/ESD	conforms to EN 61000-6-2 / EN 61000-6-4	
Protection class	IP 20	
Installation position	variable	
Approval	CE cULus ▶ 90 ATEX ▶ 50	

3.6 EL1124, EL1144, EL1134 - Introduction

Four-channel digital input terminals + 5 / 12 / 48 V_{DC}

The EL1124 (5 V_{DC}), EL1144 (12 V_{DC}) and EL1134 (48 V_{DC}) digital input terminals acquire the binary control signals and transmit them, in an electrically isolated form, to the higher-level automation unit. The EtherCAT Terminals contain four channels that indicate their signal state by means of light emitting diodes. These versions have different input voltages.

3.6.1 EL1124, EL1144, EL1134 – LEDs and connection

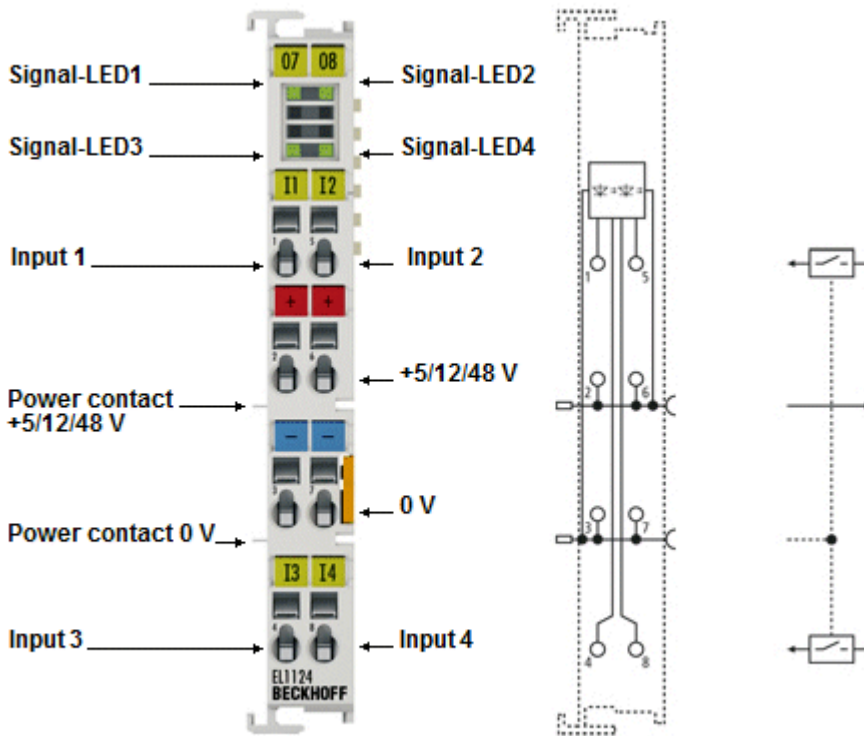

Fig. 19: EL1124

EL1124, EL1144, EL1134 – LEDs

LED	Color	Meaning	
INPUT 1- 4	green	off	EL1124: Signal voltage "0" (< 0.8 V)
			EL1144: Signal voltage "0" (< 2,4 V)
			EL1134: Signal voltage "0" (< 10 V)
		on	EL1124: Signal voltage "1" (> 2.4 V)
			EL1144: Signal voltage "1" (> 8.5 V)
			EL1134: Signal voltage "1" (> 34 V)

EL1124, EL1144, EL1134 – Connection

Terminal point		Description
Name	No.	
Input 1	1	Input 1
+ 5 / 12 / 48 V	2	+ 5 / 12 / 48 V (internally connected to terminal point 6 and positive power contact)
0 V	3	0 V (internally connected to terminal point 7 and negative power contact)
Input 3	4	Input 3
Input 2	5	Input 2
+ 5 / 12 / 48 V	6	+ 5 / 12 / 48 V (internally connected to terminal point 2 and positive power contact)
0 V	7	0 V (internally connected to terminal point 3 and negative power contact)
Input 4	8	Input 4

3.6.2 EL1124, EL1144, EL1134 - Technical data

Technical data	EL1124	EL1144	EL1134
Number of inputs	4		
Nominal voltage of inputs	5 V _{DC}	12 V _{DC}	48 V _{DC}
Signal voltage "0"	< 0.8 V	< 2.4 V	< 10 V (IEC 61131-2, type 1)
Signal voltage "1"	>2.4 V	> 8.5 V	> 34 V (IEC 61131-2, type 1)
Input filter	<<1 μs (50 ns typ.)	10 μs	10 μs
Input current	50 μA typ.	3 mA typ.	3 mA typ. (IEC 61131-2, type 1)
Supply voltage for internal E-bus circuit	via power contacts	via the E-Bus	via the E-Bus
Current consumption via E-bus	90 mA typ.		
Electrical isolation	500 V (E-bus/field voltage)		
Bit width in the process image	4 input bits		
Configuration	no address setting, configuration via TwinCAT System Manager		
Weight	approx. 55 g		
Permissible ambient temperature range during operation	0°C ... + 55°C		
Permissible ambient temperature range during storage	-25°C ... + 85°C		
Permissible relative humidity	95%, no condensation		
Dimensions (W x H x D)	approx. 15 mm x 100 mm x 70 mm (width aligned: 12 mm)		
Mounting [► 41]	on 35 mm mounting rail conforms to EN 60715		
Vibration/shock resistance	conforms to EN 60068-2-6 / EN 60068-2-27, EN 60068-2-29		
EMC resistance burst/ESD	conforms to EN 61000-6-2 / EN 61000-6-4		
Protection class	IP 20		
Installation position	variable		
Approval	CE cULus [► 90] ATEX [► 50]		

3.7 Application notes

General note

To ensure proper function of the input circuit, the power voltage is required for the following series:

Power voltage 24 V_{DC}:

- EL100x
- EL101x
- EL1104, EL1114
- EL18xx

Power voltage 5 V_{DC}:

- EL1124

Notes for EL1x1x series (10 µs typ.)

Application for frequency measurement

Due to their fast input filters (typ. 10 µs, 10..50 µs), terminals from the EL1x1x series can be used for frequency measurement. The filter time refers to the time over which an external signal with rated voltage or zero signal level must be present at the terminal point until it reaches the evaluation unit via the input circuit.

The maximum limit frequency depends on the following factors:

- EtherCAT cycle time
- Filter time in the input circuit
- Asymmetry of the filter time for rising and falling edge
- Duty factor for input signal
- Edge steepness of the input signal

Due to the production-related fluctuation range of the filter time the maximum limit frequency may be lower than the upper limit defined by the cycle when the EL1x1x is used for frequency measurement.

Example:

- Task cycle: 100 µs
- Actual filter time for rising edge: 10 µs
- Actual filter time for falling edge: 50 µs
- Duty factor 1:1

Derivation:

- Limit frequency from cycle time: 5000 Hz; depending on the cycle a half-period must be detected
- Asymmetry of the filter time: 40 µs
- Therefore minimum detectable half-period: 100 + 40 = 140 µs
- Therefore maximum detectable limit frequency: 3500 Hz

If detection of higher frequencies is required, it is advisable to either use an adequately fast input circuit (e.g. EL1202), or the input signal must compensate the actual asymmetry in the terminal through a duty factor not equal to 1:1.

4 Basics communication

4.1 EtherCAT basics

Please refer to the chapter [EtherCAT System Documentation](#) for the EtherCAT fieldbus basics.

4.2 EtherCAT cabling – wire-bound

The cable length between two EtherCAT devices must not exceed 100 m. This results from the FastEthernet technology, which, above all for reasons of signal attenuation over the length of the cable, allows a maximum link length of 5 + 90 + 5 m if cables with appropriate properties are used. See also the [Design recommendations for the infrastructure for EtherCAT/Ethernet](#).

Cables and connectors

For connecting EtherCAT devices only Ethernet connections (cables + plugs) that meet the requirements of at least category 5 (CA5) according to EN 50173 or ISO/IEC 11801 should be used. EtherCAT uses 4 wires for signal transfer.

EtherCAT uses RJ45 plug connectors, for example. The pin assignment is compatible with the Ethernet standard (ISO/IEC 8802-3).

Pin	Color of conductor	Signal	Description
1	yellow	TD +	Transmission Data +
2	orange	TD -	Transmission Data -
3	white	RD +	Receiver Data +
6	blue	RD -	Receiver Data -

Due to automatic cable detection (auto-crossing) symmetric (1:1) or cross-over cables can be used between EtherCAT devices from Beckhoff.



Note

Recommended cables

Suitable cables for the connection of EtherCAT devices can be found on the Beckhoff website!

E-Bus supply

A bus coupler can supply the EL terminals added to it with the E-bus system voltage of 5 V; a coupler is thereby loadable up to 2A as a rule (see details in respective device documentation). Information on how much current each EL terminal requires from the E-bus supply is available online and in the catalogue. If the added terminals require more current than the coupler can supply, then power feed terminals (e.g. [EL9410](#)) must be inserted at appropriate places in the terminal strand.

The pre-calculated theoretical maximum E-bus current is displayed in the TwinCAT System Manager. A shortfall is marked by a negative total amount and an exclamation mark; a power feed terminal is to be placed before such a position.

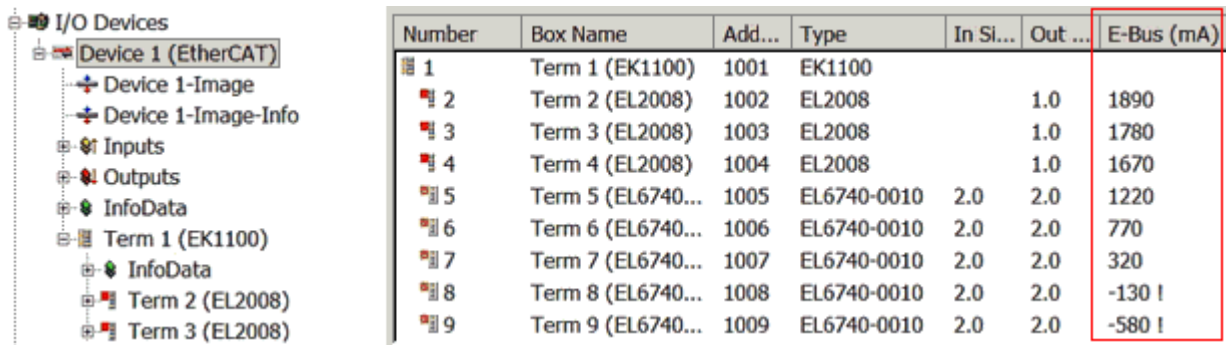



Fig. 20: System manager current calculation

 Attention	<p>Caution! Malfunction possible!</p> <p>The same ground potential must be used for the E-Bus supply of all EtherCAT terminals in a terminal block!</p>
---	--

4.3 General notes for setting the watchdog

ELxxx terminals are equipped with a safety feature (watchdog) that switches off the outputs after a specifiable time e.g. in the event of an interruption of the process data traffic, depending on the device and settings, e.g. in OFF state.

The EtherCAT slave controller (ESC) in the EL2xxx terminals features 2 watchdogs:

- SM watchdog (default: 100 ms)
- PDI watchdog (default: 100 ms)

SM watchdog (SyncManager Watchdog)

The SyncManager watchdog is reset after each successful EtherCAT process data communication with the terminal. If no EtherCAT process data communication takes place with the terminal for longer than the set and activated SM watchdog time, e.g. in the event of a line interruption, the watchdog is triggered and the outputs are set to FALSE. The OP state of the terminal is unaffected. The watchdog is only reset after a successful EtherCAT process data access. Set the monitoring time as described below.

The SyncManager watchdog monitors correct and timely process data communication with the ESC from the EtherCAT side.

PDI watchdog (Process Data Watchdog)

If no PDI communication with the EtherCAT slave controller (ESC) takes place for longer than the set and activated PDI watchdog time, this watchdog is triggered.

PDI (Process Data Interface) is the internal interface between the ESC and local processors in the EtherCAT slave, for example. The PDI watchdog can be used to monitor this communication for failure.

The PDI watchdog monitors correct and timely process data communication with the ESC from the application side.

The settings of the SM- and PDI-watchdog must be done for each slave separately in the TwinCAT System Manager.

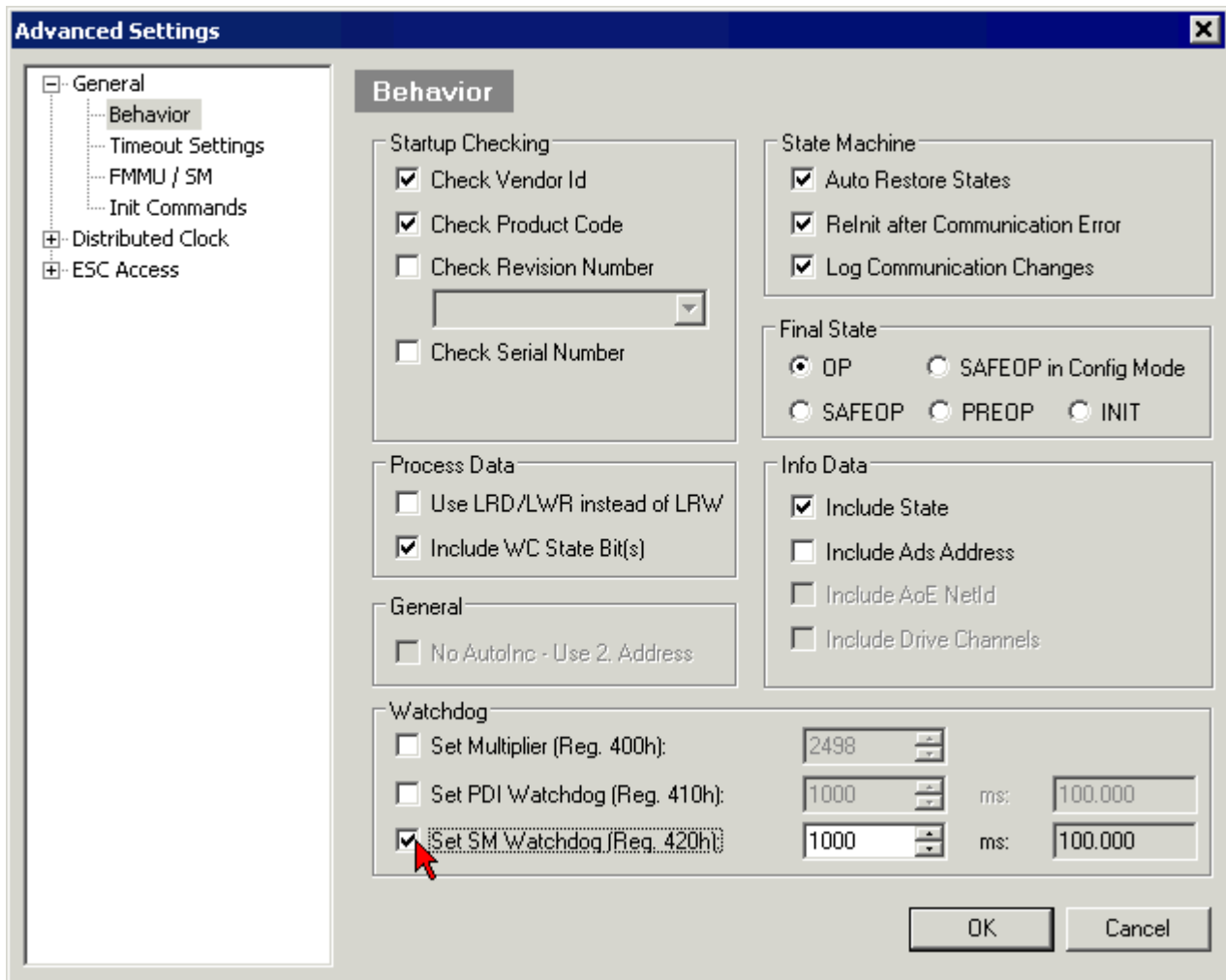

Fig. 21: EtherCAT tab -> Advanced Settings -> Behavior -> Watchdog

Notes:

- the multiplier is valid for both watchdogs.
- each watchdog has its own timer setting, the outcome of this in summary with the multiplier is a resulting time.
- Important: the multiplier/timer setting is only loaded into the slave at the start up, if the checkbox is activated.
If the checkbox is not activated, nothing is downloaded and the ESC settings remain unchanged.

Multiplier

Multiplier

Both watchdogs receive their pulses from the local terminal cycle, divided by the watchdog multiplier:

$$1/25 \text{ MHz} * (\text{watchdog multiplier} + 2) = 100 \text{ } \mu\text{s} \text{ (for default setting of 2498 for the multiplier)}$$

The standard setting of 1000 for the SM watchdog corresponds to a release time of 100 ms.

The value in multiplier + 2 corresponds to the number of basic 40 ns ticks representing a watchdog tick. The multiplier can be modified in order to adjust the watchdog time over a larger range.

Example "Set SM watchdog"

This checkbox enables manual setting of the watchdog times. If the outputs are set and the EtherCAT communication is interrupted, the SM watchdog is triggered after the set time and the outputs are erased. This setting can be used for adapting a terminal to a slower EtherCAT master or long cycle times. The default SM watchdog setting is 100 ms. The setting range is 0..65535. Together with a multiplier with a range of 1..65535 this covers a watchdog period between 0..~170 seconds.

Calculation

Multiplier = 2498 → watchdog base time = 1 25 MHz * (2498 + 2) = 0.0001 seconds = 100 μs
 SM watchdog = 10000 → 10000 * 100 μs = 1 second watchdog monitoring time

 CAUTION	<p>CAUTION! Undefined state possible!</p> <p>The function for switching off of the SM watchdog via SM watchdog = 0 is only implemented in terminals from version -0016. In previous versions this operating mode should not be used.</p>
---	---

 CAUTION	<p>CAUTION! Damage of devices and undefined state possible!</p> <p>If the SM watchdog is activated and a value of 0 is entered the watchdog switches off completely. This is the deactivation of the watchdog! Set outputs are NOT set in a safe state, if the communication is interrupted.</p>
---	---

 Note	<p>Outputs in SAFEOP state</p> <p>The default set watchdog monitoring sets the outputs of the module in a safe state - depending on the settings in SAFEOP and OP - e.g. in OFF state. If this is prevented by deactivation of the watchdog monitoring in the module, the outputs can be switched or set also in the SAFEOP state.</p>
---	---

4.4 EtherCAT State Machine

The state of the EtherCAT slave is controlled via the EtherCAT State Machine (ESM). Depending upon the state, different functions are accessible or executable in the EtherCAT slave. Specific commands must be sent by the EtherCAT master to the device in each state, particularly during the bootup of the slave.

A distinction is made between the following states:

- Init
- Pre-Operational
- Safe-Operational and
- Operational
- Boot

The regular state of each EtherCAT slave after bootup is the OP state.

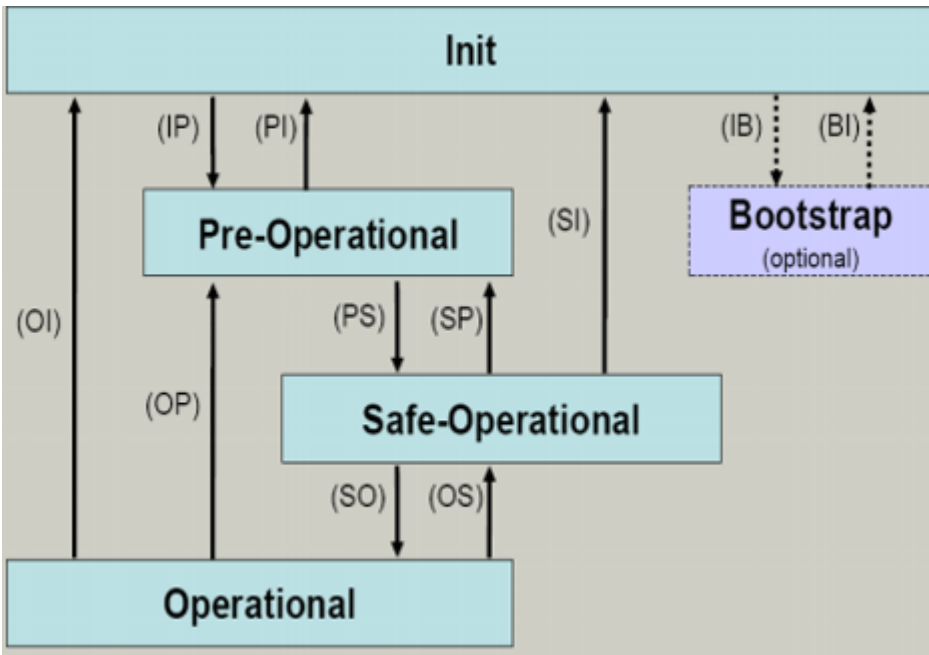

Fig. 22: States of the EtherCAT State Machine

Init

After switch-on the EtherCAT slave in the *Init* state. No mailbox or process data communication is possible. The EtherCAT master initializes sync manager channels 0 and 1 for mailbox communication.

Pre-Operational (Pre-Op)

During the transition between *Init* and *Pre-Op* the EtherCAT slave checks whether the mailbox was initialized correctly.

In *Pre-Op* state mailbox communication is possible, but not process data communication. The EtherCAT master initializes the sync manager channels for process data (from sync manager channel 2), the FMMU channels and, if the slave supports configurable mapping, PDO mapping or the sync manager PDO assignment. In this state the settings for the process data transfer and perhaps terminal-specific parameters that may differ from the default settings are also transferred.

Safe-Operational (Safe-Op)

During transition between *Pre-Op* and *Safe-Op* the EtherCAT slave checks whether the sync manager channels for process data communication and, if required, the distributed clocks settings are correct. Before it acknowledges the change of state, the EtherCAT slave copies current input data into the associated DP-RAM areas of the EtherCAT slave controller (ECSC).

In *Safe-Op* state mailbox and process data communication is possible, although the slave keeps its outputs in a safe state, while the input data are updated cyclically.



Note

Outputs in SAFEOP state

The default set watchdog monitoring sets the outputs of the module in a safe state - depending on the settings in SAFEOP and OP - e.g. in OFF state. If this is prevented by deactivation of the watchdog monitoring in the module, the outputs can be switched or set also in the SAFEOP state.

Operational (Op)

Before the EtherCAT master switches the EtherCAT slave from *Safe-Op* to *Op* it must transfer valid output data.

In the *Op* state the slave copies the output data of the masters to its outputs. Process data and mailbox communication is possible.

Boot

In the *Boot* state the slave firmware can be updated. The *Boot* state can only be reached via the *Init* state.

In the *Boot* state mailbox communication via the *file access over EtherCAT* (FoE) protocol is possible, but no other mailbox communication and no process data communication.

4.5 CoE - Interface: notes

CoE-Interface

This device has no CoE.

Detailed information on the CoE interface can be found in the [EtherCAT system documentation](#) on the Beckhoff website.

4.6 Distributed Clock

The distributed clock represents a local clock in the EtherCAT slave controller (ESC) with the following characteristics:

- Unit *1 ns*
- Zero point *1.1.2000 00:00*
- Size *64 bit* (sufficient for the next 584 years; however, some EtherCAT slaves only offer 32-bit support, i.e. the variable overflows after approx. 4.2 seconds)
- The EtherCAT master automatically synchronizes the local clock with the master clock in the EtherCAT bus with a precision of < 100 ns.

For detailed information please refer to the [EtherCAT system description](#).

5 Mounting and wiring

5.1 Installation on mounting rails

	<p>Risk of electric shock and damage of device!</p> <p>Bring the bus terminal system into a safe, powered down state before starting installation, disassembly or wiring of the Bus Terminals!</p>
---	---

Assembly

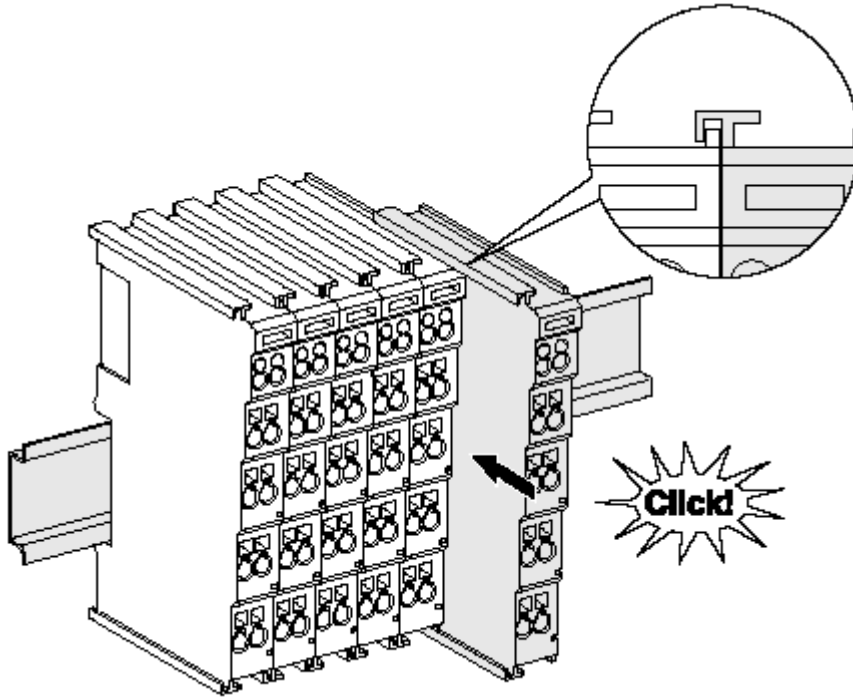



Fig. 23: Attaching on mounting rail

The Bus Coupler and Bus Terminals are attached to commercially available 35 mm mounting rails (DIN rails according to EN 60715) by applying slight pressure:

1. First attach the Fieldbus Coupler to the mounting rail.
2. The Bus Terminals are now attached on the right-hand side of the Fieldbus Coupler. Join the components with tongue and groove and push the terminals against the mounting rail, until the lock clicks onto the mounting rail.

If the Terminals are clipped onto the mounting rail first and then pushed together without tongue and groove, the connection will not be operational! When correctly assembled, no significant gap should be visible between the housings.

	<p>Fixing of mounting rails</p> <p>The locking mechanism of the terminals and couplers extends to the profile of the mounting rail. At the installation, the locking mechanism of the components must not come into conflict with the fixing bolts of the mounting rail. To mount the mounting rails with a height of 7.5 mm under the terminals and couplers, you should use flat mounting connections (e.g. countersunk screws or blind rivets).</p>
---	---

Disassembly

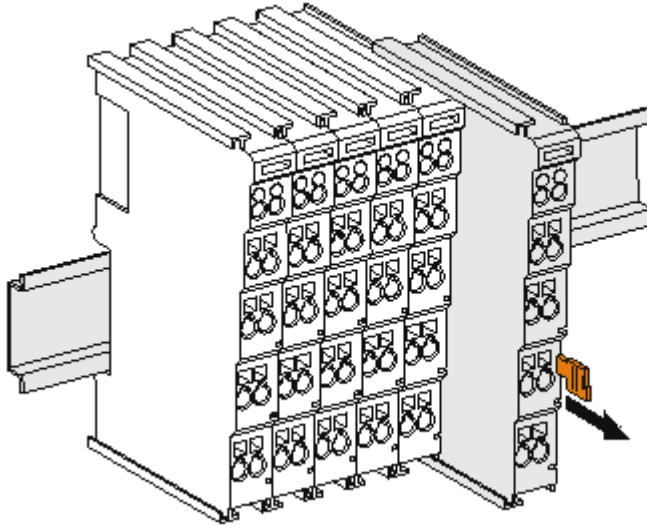

Fig. 24: Disassembling of terminal

Each terminal is secured by a lock on the mounting rail, which must be released for disassembly:

1. Pull the terminal by its orange-colored lugs approximately 1 cm away from the mounting rail. In doing so for this terminal the mounting rail lock is released automatically and you can pull the terminal out of the bus terminal block easily without excessive force.
2. Grasp the released terminal with thumb and index finger simultaneous at the upper and lower grooved housing surfaces and pull the terminal out of the bus terminal block.

Connections within a bus terminal block

The electric connections between the Bus Coupler and the Bus Terminals are automatically realized by joining the components:

- The six spring contacts of the K-Bus/E-Bus deal with the transfer of the data and the supply of the Bus Terminal electronics.
- The power contacts deal with the supply for the field electronics and thus represent a supply rail within the bus terminal block. The power contacts are supplied via terminals on the Bus Coupler (up to 24 V) or for higher voltages via power feed terminals.



Note

Power Contacts

During the design of a bus terminal block, the pin assignment of the individual Bus Terminals must be taken account of, since some types (e.g. analog Bus Terminals or digital 4-channel Bus Terminals) do not or not fully loop through the power contacts. Power Feed Terminals (KL91xx, KL92xx or EL91xx, EL92xx) interrupt the power contacts and thus represent the start of a new supply rail.

PE power contact

The power contact labeled PE can be used as a protective earth. For safety reasons this contact mates first when plugging together, and can ground short-circuit currents of up to 125 A.

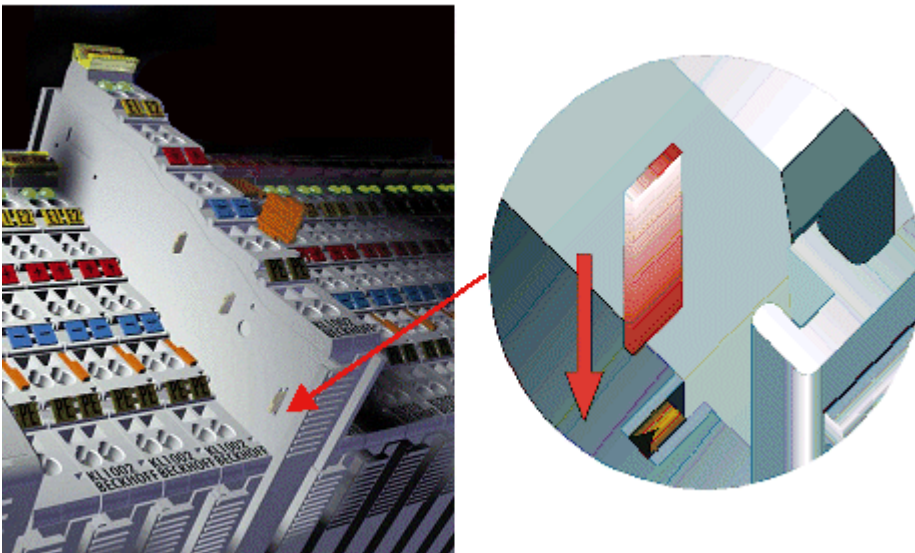





Fig. 25: Power contact on left side

 Attention	<p>Possible damage of the device</p> <p>Note that, for reasons of electromagnetic compatibility, the PE contacts are capacitatively coupled to the mounting rail. This may lead to incorrect results during insulation testing or to damage on the terminal (e.g. disruptive discharge to the PE line during insulation testing of a consumer with a nominal voltage of 230 V). For insulation testing, disconnect the PE supply line at the Bus Coupler or the Power Feed Terminal! In order to decouple further feed points for testing, these Power Feed Terminals can be released and pulled at least 10 mm from the group of terminals.</p>
---	---

 WARNING	<p>Risk of electric shock!</p> <p>The PE power contact must not be used for other potentials!</p>
---	--

5.2 Installation instructions for enhanced mechanical load capacity

 WARNING	<p>Risk of injury through electric shock and damage to the device!</p> <p>Bring the Bus Terminal system into a safe, de-energized state before starting mounting, disassembly or wiring of the Bus Terminals!</p>
---	--

Additional checks

The terminals have undergone the following additional tests:

Verification	Explanation
Vibration	10 frequency runs in 3 axes
	6 Hz < f < 60 Hz displacement 0.35 mm, constant amplitude
	60.1 Hz < f < 500 Hz acceleration 5 g, constant amplitude
Shocks	1000 shocks in each direction, in 3 axes
	25 g, 6 ms

Additional installation instructions

For terminals with enhanced mechanical load capacity, the following additional installation instructions apply:

- Any installation position is permitted
- Use a mounting rail according to EN 60715 TH35-15
- Fix the terminal segment on both sides of the mounting rail with a mechanical fixture, e.g. an earth terminal or reinforced end clamp
- The maximum total extension of the terminal segment (without coupler) is: 64 terminals (12 mm mounting with) or 32 terminals (24 mm mounting with)
- Avoid deformation, twisting, crushing and bending of the mounting rail during edging and installation of the rail
- The mounting points of the mounting rail must be set at 5 cm intervals
- Use countersunk head screws to fasten the mounting rail
- The free length between the strain relief and the wire connection should be kept as short as possible. A distance of approx. 10 cm should be maintained to the cable duct.

5.3 Connection system



Risk of electric shock and damage of device!

Bring the bus terminal system into a safe, powered down state before starting installation, disassembly or wiring of the Bus Terminals!

Overview

The Bus Terminal system offers different connection options for optimum adaptation to the respective application:

- The terminals of KLxxxx and ELxxxx series with standard wiring include electronics and connection level in a single enclosure.
- The terminals of KSxxxx and ESxxxx series feature a pluggable connection level and enable steady wiring while replacing.
- The High Density Terminals (HD Terminals) include electronics and connection level in a single enclosure and have advanced packaging density.

Standard wiring



Fig. 26: Standard wiring

The terminals of KLxxxx and ELxxxx series have been tried and tested for years. They feature integrated screwless spring force technology for fast and simple assembly.

Pluggable wiring

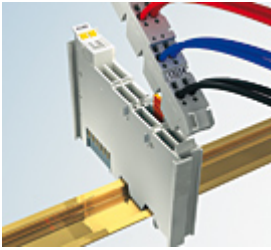

Fig. 27: Pluggable wiring

The terminals of KSxxxx and ESxxxx series feature a pluggable connection level. The assembly and wiring procedure for the KS series is the same as for the KLxxxx and ELxxxx series. The KS/ES series terminals enable the complete wiring to be removed as a plug connector from the top of the housing for servicing. The lower section can be removed from the terminal block by pulling the unlocking tab. Insert the new component and plug in the connector with the wiring. This reduces the installation time and eliminates the risk of wires being mixed up.

The familiar dimensions of the terminal only had to be changed slightly. The new connector adds about 3 mm. The maximum height of the terminal remains unchanged.

A tab for strain relief of the cable simplifies assembly in many applications and prevents tangling of individual connection wires when the connector is removed.

Conductor cross sections between 0.08 mm² and 2.5 mm² can continue to be used with the proven spring force technology.

The overview and nomenclature of the product names for KSxxxx and ESxxxx series has been retained as known from KLxxxx and ELxxxx series.

High Density Terminals (HD Terminals)



Fig. 28: High Density Terminals

The Bus Terminals from these series with 16 connection points are distinguished by a particularly compact design, as the packaging density is twice as large as that of the standard 12 mm Bus Terminals. Massive conductors and conductors with a wire end sleeve can be inserted directly into the spring loaded terminal point without tools.

 Note	<p>Wiring HD Terminals</p> <p>The High Density (HD) Terminals of the KLx8xx and ELx8xx series doesn't support steady wiring.</p>
--	---

Ultrasonically "bonded" (ultrasonically welded) conductors

 Note	<p>Ultrasonically "bonded" conductors</p> <p>It is also possible to connect the Standard and High Density Terminals with ultrasonically "bonded" (ultrasonically welded) conductors. In this case, please note the tables concerning the <u>wire-size width</u> [▶ 46] below!</p>
--	--

Wiring

Terminals for standard wiring ELxxxx / KLxxxx and terminals for steady wiring ESxxxx / KSxxxx

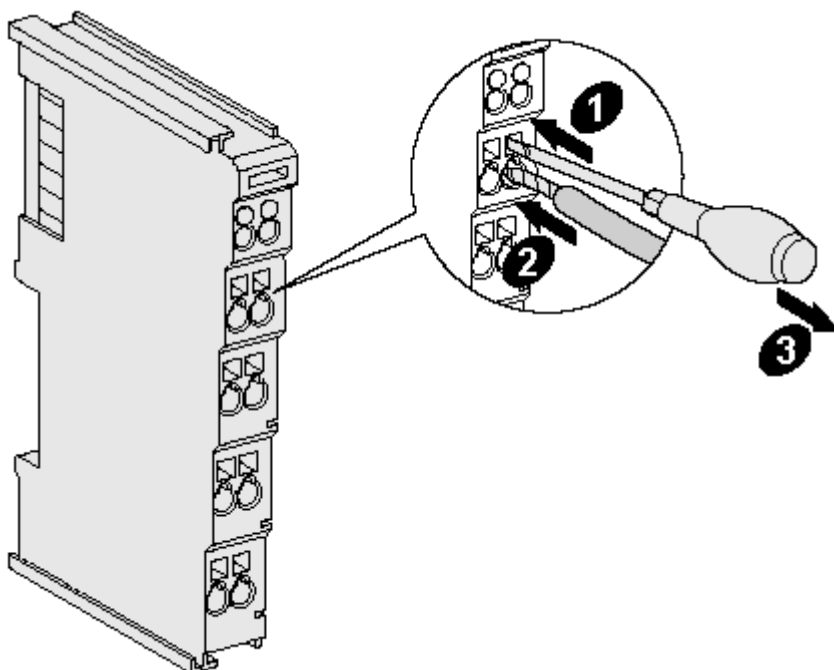

Fig. 29: Mounting a cable on a terminal connection

Up to eight connections enable the connection of solid or finely stranded cables to the Bus Terminals. The terminals are implemented in spring force technology. Connect the cables as follows:

1. Open a spring-loaded terminal by slightly pushing with a screwdriver or a rod into the square opening above the terminal.
2. The wire can now be inserted into the round terminal opening without any force.
3. The terminal closes automatically when the pressure is released, holding the wire securely and permanently.

Terminal housing	ELxxxx, KLxxxx	ESxxxx, KSxxxx
Wire size width	0.08 ... 2,5 mm ²	0.08 ... 2.5 mm ²
Wire stripping length	8 ... 9 mm	9 ... 10 mm

High Density Terminals ELx8xx, KLx8xx (HD)

The conductors of the HD Terminals are connected without tools for single-wire conductors using the direct plug-in technique, i.e. after stripping the wire is simply plugged into the contact point. The cables are released, as usual, using the contact release with the aid of a screwdriver. See the following table for the suitable wire size width.

Terminal housing	High Density Housing
Wire size width (conductors with a wire end sleeve)	0.14... 0.75 mm ²
Wire size width (single core wires)	0.08 ... 1.5 mm ²
Wire size width (fine-wire conductors)	0.25 ... 1.5 mm ²
Wire size width (ultrasonically "bonded" conductors)	only 1.5 mm ² (see notice ▶ 45 !!)
Wire stripping length	8 ... 9 mm

Shielding

 Note	<p>Shielding</p> <p>Analog sensors and actors should always be connected with shielded, twisted paired wires.</p>
--	--

5.4 Installation positions

 Attention	<p>Constraints regarding installation position and operating temperature range</p> <p>Please refer to the technical data for a terminal to ascertain whether any restrictions regarding the installation position and/or the operating temperature range have been specified. When installing high power dissipation terminals ensure that an adequate spacing is maintained between other components above and below the terminal in order to guarantee adequate ventilation!</p>
---	---

Optimum installation position (standard)

The optimum installation position requires the mounting rail to be installed horizontally and the connection surfaces of the EL/KL terminals to face forward (see Fig. "Recommended distances for standard installation position"). The terminals are ventilated from below, which enables optimum cooling of the electronics through convection. "From below" is relative to the acceleration of gravity.

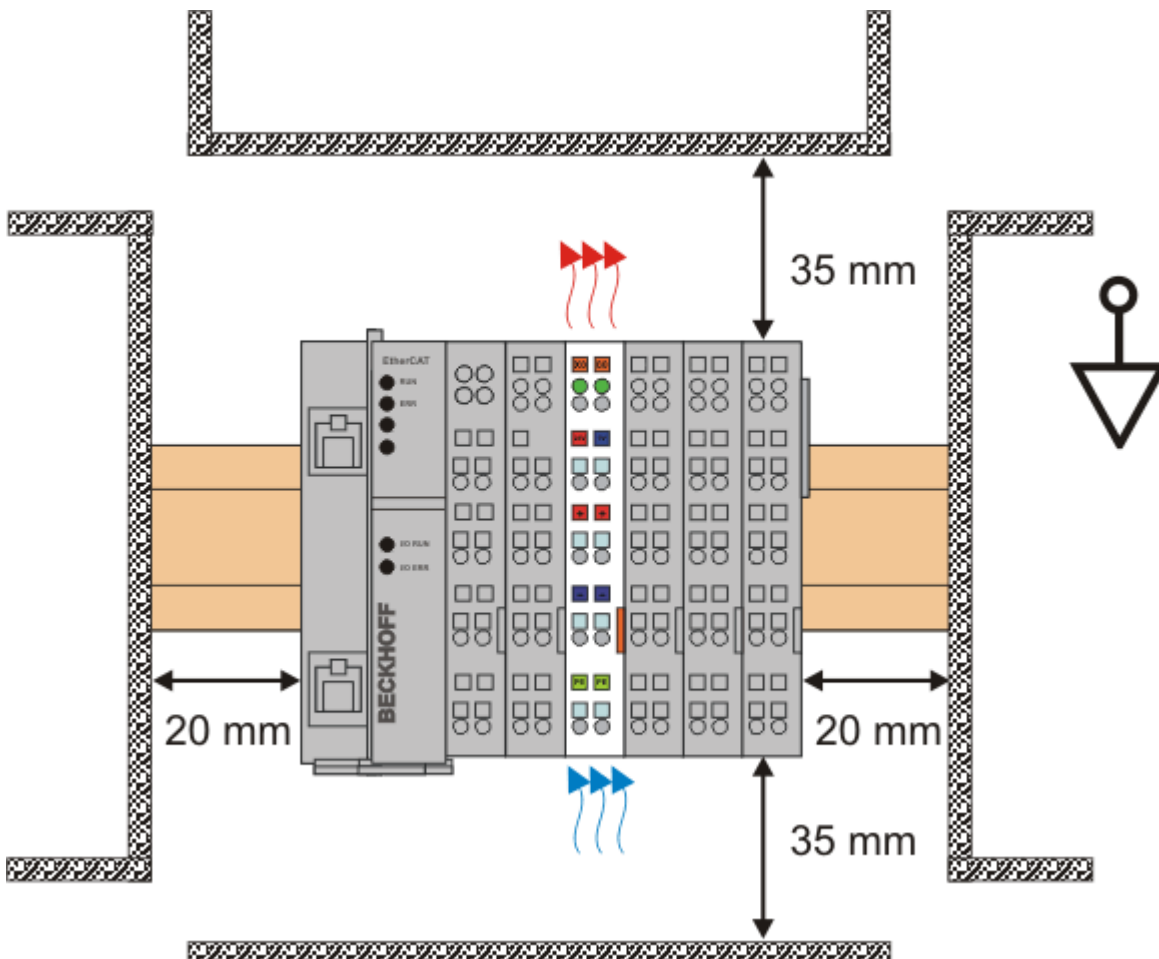

Fig. 30: Recommended distances for standard installation position

Compliance with the distances shown in Fig. "Recommended distances for standard installation position" is recommended.

Other installation positions

All other installation positions are characterized by different spatial arrangement of the mounting rail - see Fig "Other installation positions".

The minimum distances to ambient specified above also apply to these installation positions.

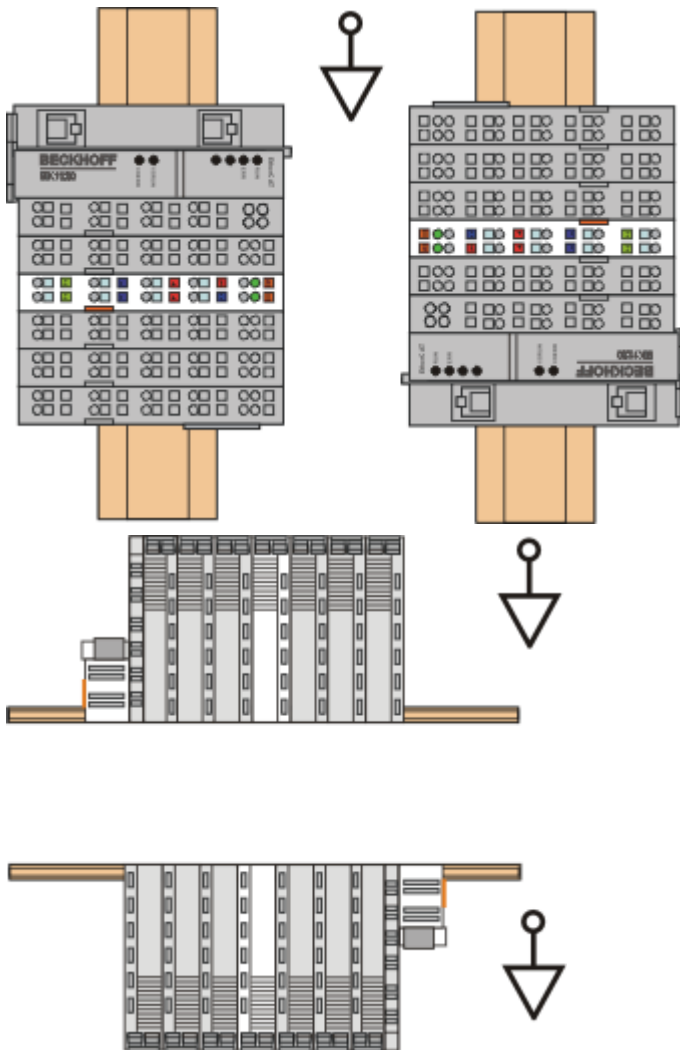

Fig. 31: Other installation positions

5.5 Mounting of Passive Terminals



Note

Hint for mounting passive terminals

EtherCAT Bus Terminals (ELxxxx / ESxxxx), which do not take an active part in data transfer within the bus terminal block are so called Passive Terminals. The Passive Terminals have no current consumption out of the E-Bus To ensure an optimal data transfer, you must not directly string together more than 2 Passive Terminals!

Examples for mounting passive terminals (highlighted)

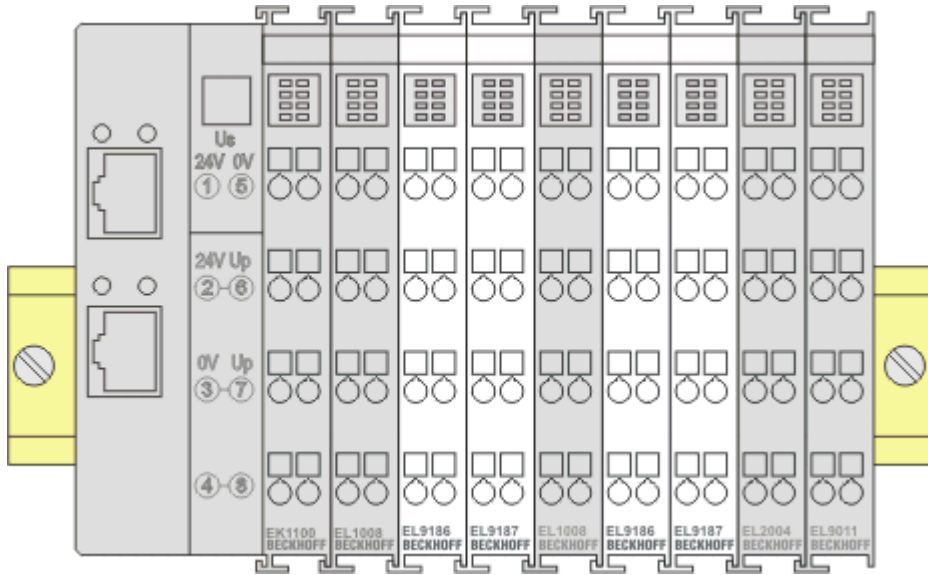

Fig. 32: Correct configuration

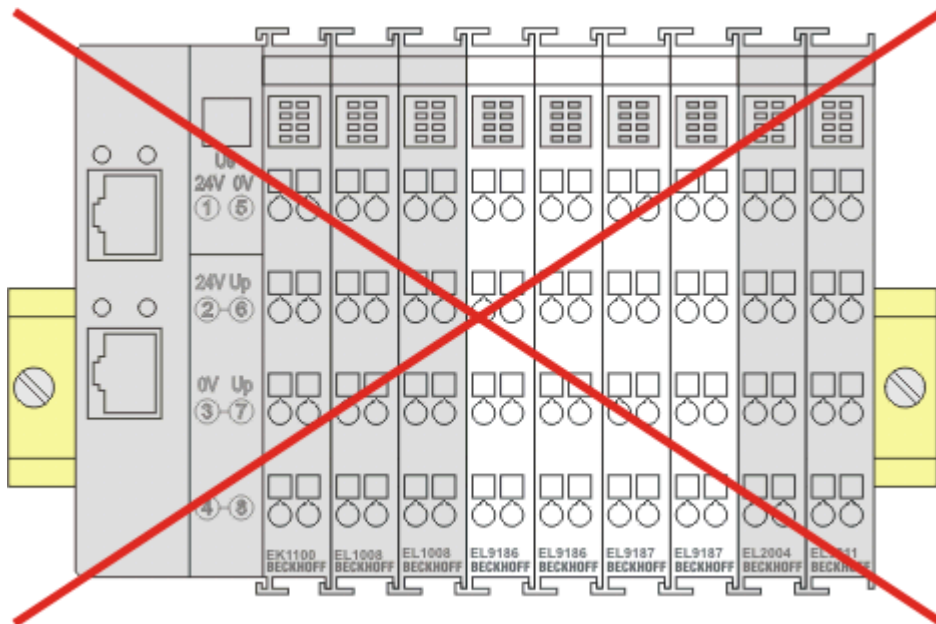

Fig. 33: Incorrect configuration

5.6 ATEX - Special conditions



WARNING

Observe the special conditions for the intended use of Beckhoff fieldbus components in potentially explosive areas (directive 94/9/EU)!

✓ Conditions

- a) The certified components are to be installed in a suitable housing that guarantees a protection class of at least IP54 in accordance with EN 60529! The environmental conditions during use are thereby to be taken into account!
- b) If the temperatures during rated operation are higher than 70°C at the feed-in points of cables, lines or pipes, or higher than 80°C at the wire branching points, then cables must be selected whose temperature data correspond to the actual measured temperature values!
- c) Observe the permissible ambient temperature range of 0 - 55°C for the use of Beckhoff fieldbus components in potentially explosive areas!
- d) Measures must be taken to protect against the rated operating voltage being exceeded by more than 40% due to short-term interference voltages!
- e) The individual terminals may only be unplugged or removed from the Bus Terminal system if the supply voltage has been switched off or if a non-explosive atmosphere is ensured!
- f) The connections of the certified components may only be connected or disconnected if the supply voltage has been switched off or if a non-explosive atmosphere is ensured!
- g) The fuses of the KL92xx power feed terminals may only be exchanged if the supply voltage has been switched off or if a non-explosive atmosphere is ensured!
- h) Address selectors and ID switches may only be adjusted if the supply voltage has been switched off or if a non-explosive atmosphere is ensured!

Standards

The fundamental health and safety requirements are fulfilled by compliance with the following standards:

- EN 60079-0: 2006
- EN 60079-15: 2005

Marking

The Beckhoff fieldbus components certified for potentially explosive areas bear one of the following markings:



II 3 G Ex nA II T4 KEMA 10ATEX0075 X Ta: 0 - 55°C

or



II 3 G Ex nA nC IIC T4 KEMA 10ATEX0075 X Ta: 0 - 55°C

Serial number

The Beckhoff fieldbus components bear a serial number that is structured as follows:

WW YY FF HH

WW - week of production (CW, calendar week)

YY - year of production

FF - firmware version

HH - hardware version

Example with ser. no.: 35 04 1B 01:

35 - week of production 35

04 - year of production 2004

1B - firmware version 1B

01 - hardware version 01

6 Commissioning

6.1 TwinCAT 2.1x

6.1.1 Installation of the TwinCAT real-time driver

In order to assign real-time capability to a standard Ethernet port of an IPC controller, the Beckhoff real-time driver has to be installed on this port under Windows.

This can be done in several ways. One option is described here.

In the System Manager call up the TwinCAT overview of the local network interfaces via Options -> Show Real Time Ethernet Compatible Devices.

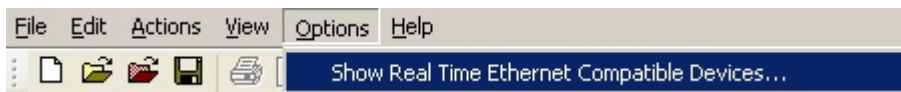

Fig. 34: System Manager option

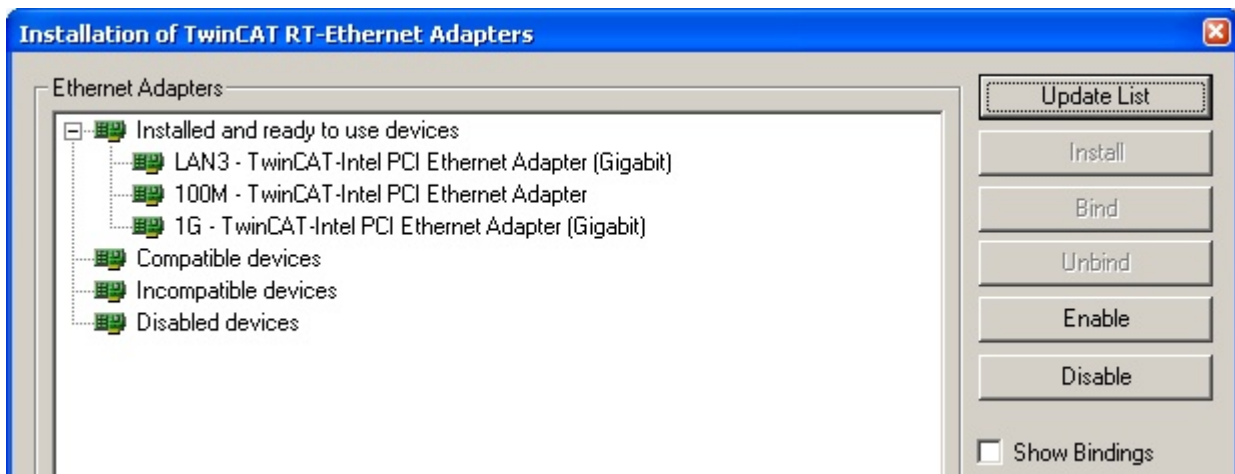

Fig. 35: Overview of network interfaces

Interfaces listed under “Compatible devices” can be assigned a driver via the “Install” button. A driver should only be installed on compatible devices.

A Windows warning regarding the unsigned driver can be ignored.

Alternatively, the compatible Ethernet ports can be viewed in the System Manager via EtherCAT properties.



Fig. 36: EtherCAT device properties

After the installation the driver appears activated in the Windows overview for the network interface (Windows Start -->System Properties -> Network)

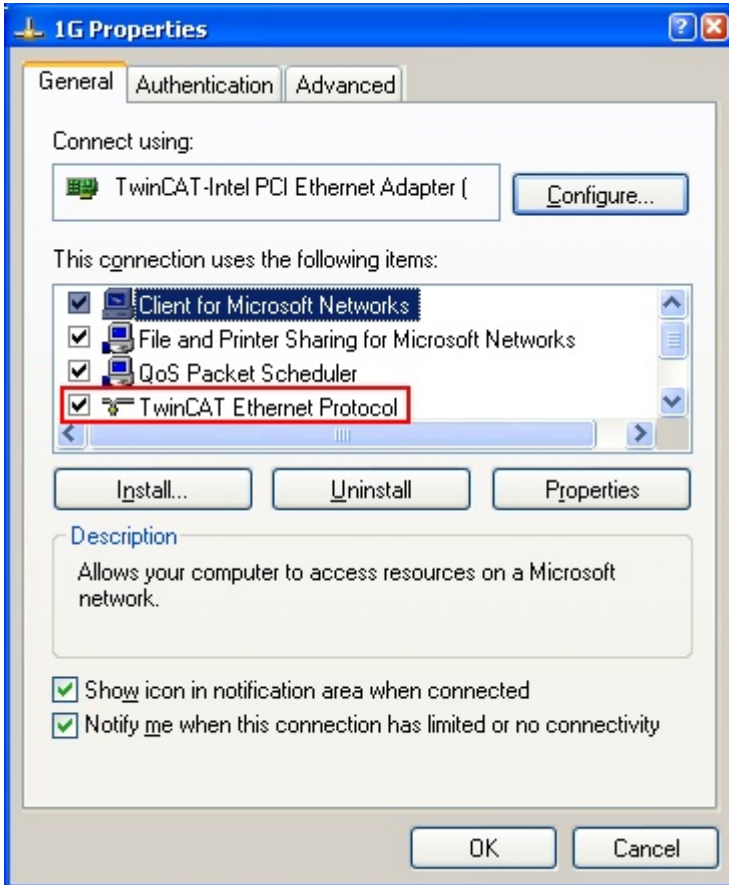

Fig. 37: Windows properties of the network interface

Other possible settings are to be avoided:

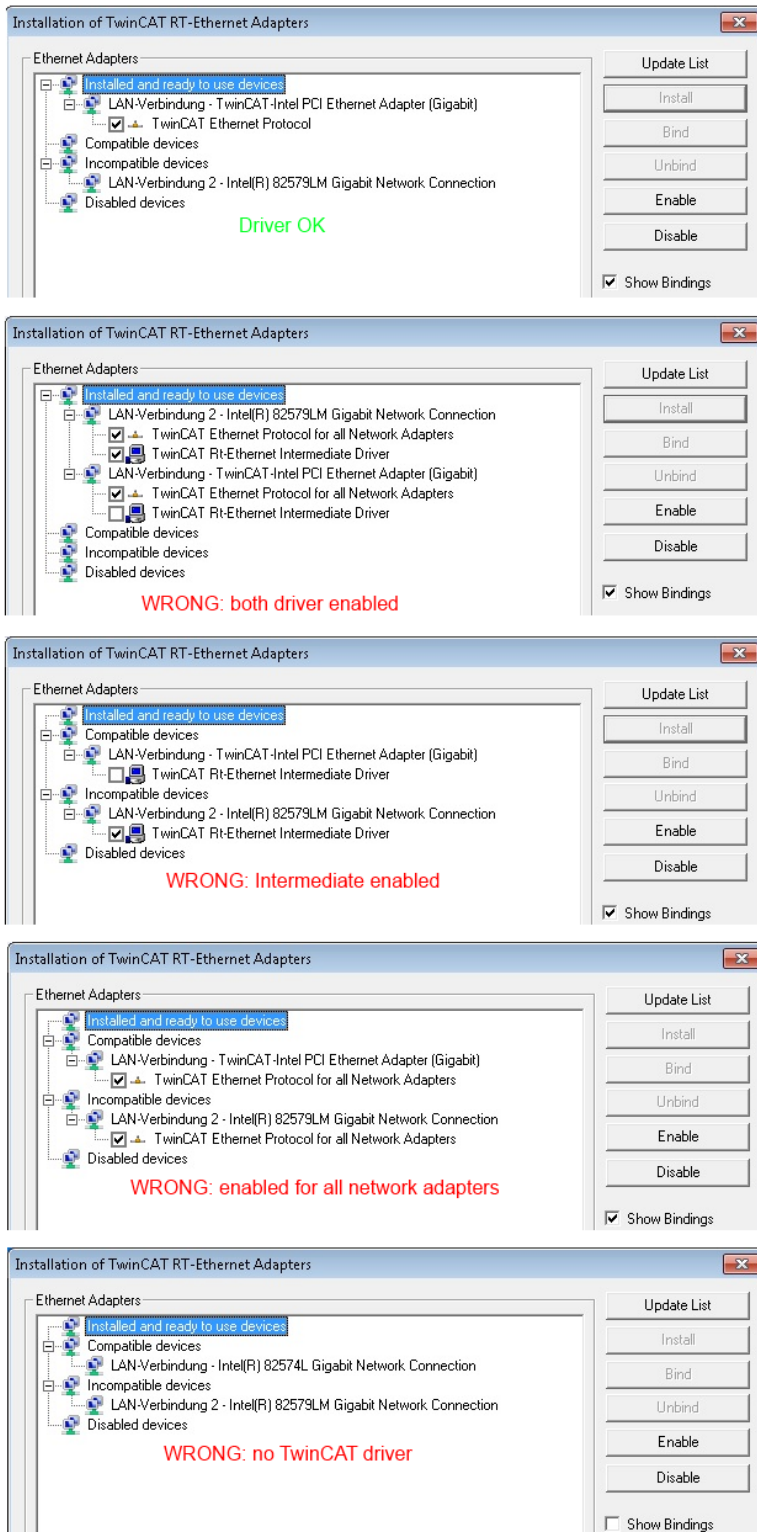

Fig. 38: Incorrect driver settings for the Ethernet port

IP address of the port used



Note

IP address/DHCP

In most cases an Ethernet port that is configured as an EtherCAT device will not transport general IP packets. For this reason and in cases where an EL6601 or similar devices are used it is useful to specify a fixed IP address for this port via the “Internet Protocol TCP/IP” driver setting and to disable DHCP. In this way the delay associated with the DHCP client for the Ethernet port assigning itself a default IP address in the absence of a DHCP server is avoided. A suitable address space is 192.168.x.x, for example.

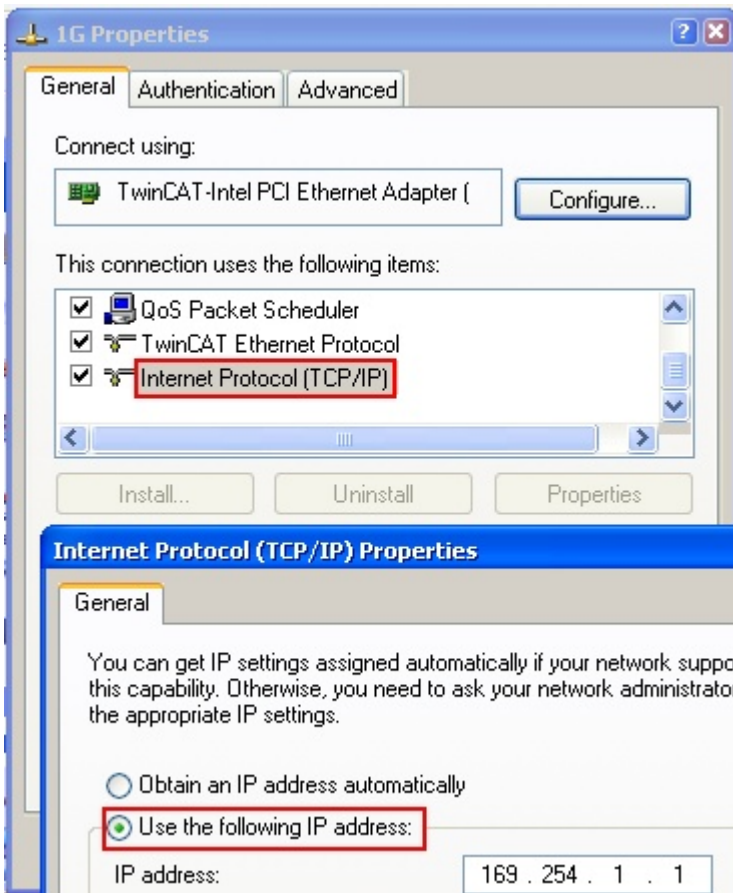

Fig. 39: TCP/IP setting for the Ethernet port

6.1.2 Notes regarding ESI device description

Installation of the latest ESI device description

The TwinCAT EtherCAT master/System Manager needs the device description files for the devices to be used in order to generate the configuration in online or offline mode. The device descriptions are contained in the so-called ESI files (EtherCAT Slave Information) in XML format. These files can be requested from the respective manufacturer and are made available for download. An *.xml file may contain several device descriptions.

The ESI files for Beckhoff EtherCAT devices are available on the [Beckhoff website](#).

The ESI files should be stored in the TwinCAT installation directory (default TwinCAT2: C:\TwinCAT\IO\EtherCAT). The files are read (once) when a new System Manager window is opened, if they have changed since the last time the System Manager window was opened.

A TwinCAT installation includes the set of Beckhoff ESI files that was current at the time when the TwinCAT build was created.

For TwinCAT 2.11/TwinCAT 3 and higher, the ESI directory can be updated from the System Manager, if the programming PC is connected to the Internet (Option -> "Update EtherCAT Device Descriptions")

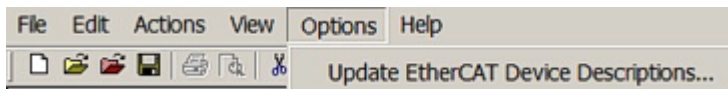



Fig. 40: For TwinCAT 2.11 and higher, the System Manager can search for current Beckhoff ESI files automatically, if an online connection is available

 Note	ESI The *.xml files are associated with *.xsd files, which describe the structure of the ESI XML files. To update the ESI device descriptions, both file types should therefore be updated.
--	---

Device differentiation

EtherCAT devices/slaves are distinguished by 4 properties, which determine the full device identifier. The EL2521-0025-1018 ID consists of

- family key "EL"
- name "2521"
- type "0025"
- and revision "1018"

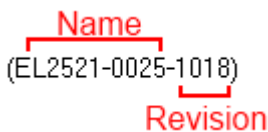

Fig. 41: Identifier structure

The order identifier consisting of name + type (here: EL2521-0010) describes the device function. The revision indicates the technical progress and is managed by Beckhoff. In principle, a device with a higher revision can replace a device with a lower revision, unless specified otherwise, e.g. in the documentation. Each revision has its own ESI description. See [further notes](#) [► 8].

Online description

If the EtherCAT configuration is created online through scanning of real devices (see section Online setup) and no ESI descriptions are available for a slave (specified by name and revision) that was found, the System Manager asks whether the description stored in the device should be used. In any case, the System Manager needs this information for setting up the cyclic and acyclic communication with the slave correctly.

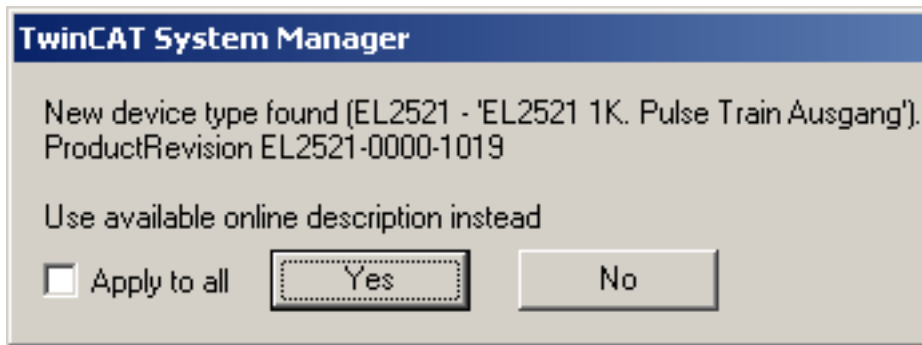

Fig. 42: OnlineDescription information window

In TwinCAT 3.x a similar window appears, which also offers the Web update:

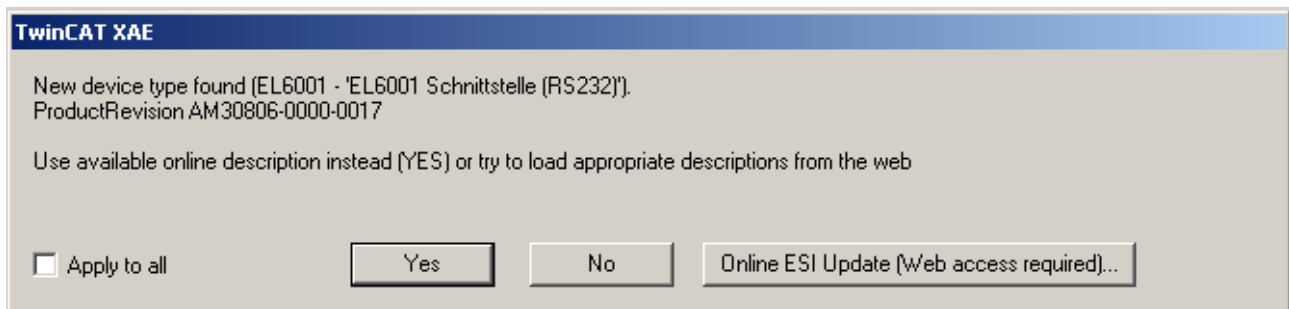



Fig. 43: Information window OnlineDescription, TwinCAT 3.x

If possible, the Yes is to be rejected and the required ESI is to be requested from the device manufacturer. After installation of the XML/XSD file the configuration process should be repeated.

 Attention	<p>Changing the 'usual' configuration through a scan</p> <ul style="list-style-type: none"> ✓ If a scan discovers a device that is not yet known to TwinCAT, distinction has to be made between two cases. Taking the example here of the EL2521-0000 in the revision 1019 <ul style="list-style-type: none"> a) no ESI is present for the EL2521-0000 device at all, either for the revision 1019 or for an older revision. The ESI must then be requested from the manufacturer (in this case Beckhoff). b) an ESI is present for the EL2521-0000 device, but only in an older revision, e.g. 1018 or 1017. In this case an in-house check should first be performed to determine whether the spare parts stock allows the integration of the increased revision into the configuration at all. A new/higher revision usually also brings along new features. If these are not to be used, work can continue without reservations with the previous revision 1018 in the configuration. This is also stated by the Beckhoff compatibility rule.
---	---

Refer in particular to the chapter 'General notes on the use of Beckhoff EtherCAT IO components' and for manual configuration to the chapter 'Configuration creation – manual'

If the OnlineDescription is used regardless, the System Manager reads a copy of the device description from the EEPROM in the EtherCAT slave. In complex slaves the size of the EEPROM may not be sufficient for the complete ESI, in which case the ESI would be incomplete in the configurator. The route via the ESI files is therefore recommended.

The System Manager creates a new file "OnlineDescription0000...xml" in its ESI directory, which contains all ESI descriptions that were read online.

OnlineDescriptionCache000000002.xml

Fig. 44: File OnlineDescription.xml created by the System Manager

If slaves are added manually to the configuration at a later stage, slaves created in the manner described above are indicated by an arrow, see Fig. "Arrow indicates ESI recorded from OnlineDescription", EL2521.

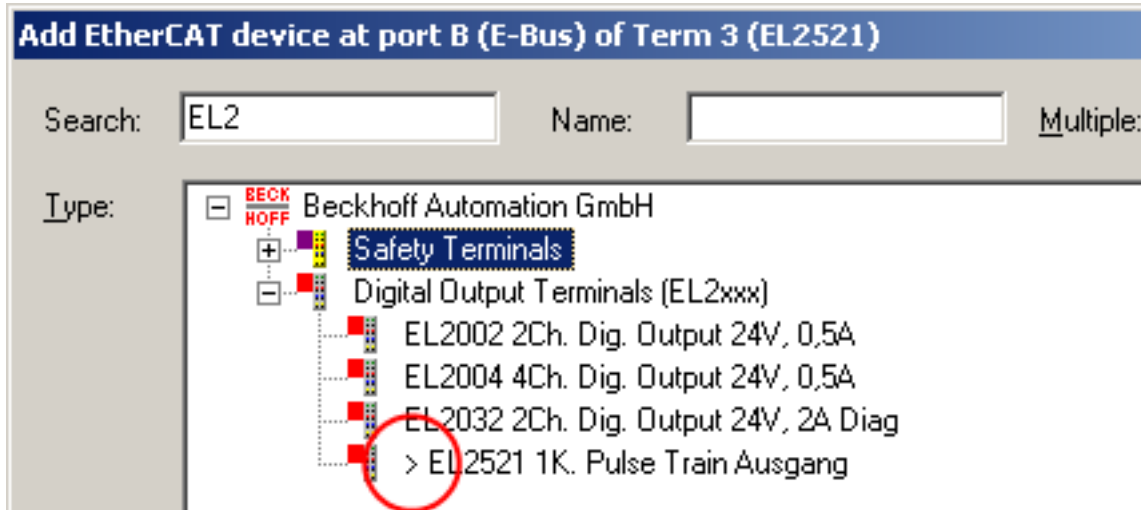

Fig. 45: Arrow indicates ESI recorded from OnlineDescription

If such ESI files are used and the manufacturer's files become available later, the file OnlineDescription.xml should be deleted as follows:

- close all System Manager windows
- restart TwinCAT in Config mode
- delete "OnlineDescription0000...xml"
- restart TwinCAT System Manager

This file should not be visible after this procedure, if necessary press <F5> to update



Note

OnlineDescription for TwinCAT 3.x

In addition to the file described above "OnlineDescription0000...xml", a so called EtherCAT cache with new discovered devices is created by TwinCAT 3.x (e.g. under Windows 7)C: \User\[USERNAME]\AppData\Roaming\Beckhoff\TwinCAT3\Components\Base\EtherCAT-Cache.xml (Please note the language settings of the OS!)You have to delete this file, too.

Faulty ESI file

If an ESI file is faulty and the System Manager is unable to read it, the System Manager brings up an information window.



Fig. 46: Information window for faulty ESI file

Reasons may include:

- Structure of the *.xml does not correspond to the associated *.xsd file --> check your schematics
- Contents cannot be translated into a device description --> contact the file manufacturer

6.1.3 Offline configuration creation (master: TwinCAT 2.x)

Distinction between Online and Offline

The distinction between online and offline refers to the presence of the actual I/O environment (drives, terminals). If the configuration is to be prepared in advance of the system configuration as a programming system, e.g. on a laptop, this is only possible in “Offline configuration” mode. In this case all components have to be entered manually in the configuration, e.g. based on the electrical design.

If the designed control system is already connected to the EtherCAT system and all components are energised and the infrastructure is ready for operation, the TwinCAT configuration can simply be generated through “scanning” from the runtime system. This is referred to as online configuration.

In any case, during each startup the EtherCAT master checks whether the slaves it finds match the configuration. This test can be parameterised in the extended slave settings.



Note

Installation of the latest ESI-XML device description

The TwinCAT EtherCAT master/System Manager needs the device description files for the devices to be used in order to generate the configuration in online or offline mode. The device descriptions are contained in the so-called ESI files (EtherCAT Slave Information) in XML format. These files can be requested from the respective manufacturer and are made available for download. The ESIs for Beckhoff EtherCAT devices are provided on the [Beckhoff website](#). The ESI files should be saved in the TwinCAT installation directory (default: C:\TwinCAT\IO\EtherCAT). The files are read (once) when a new System Manager window is opened. A TwinCAT installation includes the set of Beckhoff ESI files that was current at the time when the TwinCAT build was created.

For TwinCAT 2.11 and higher, the ESI directory can be updated from the System Manager, if the programming PC is connected to the Internet (Option -> “Update EtherCAT Device Descriptions”)

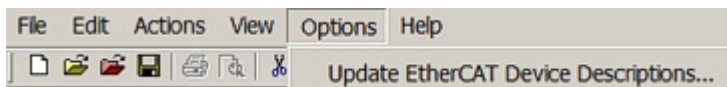

Fig. 47: Updating of the ESI directory

The following conditions must be met before a configuration can be set up:

- the [EtherCAT device must be created/defined in the System Manager \[► 60\]](#)
- the [EtherCAT slaves must be defined \[► 62\]](#)

Creating the EtherCAT device

Create an EtherCAT device in an empty System Manager window.

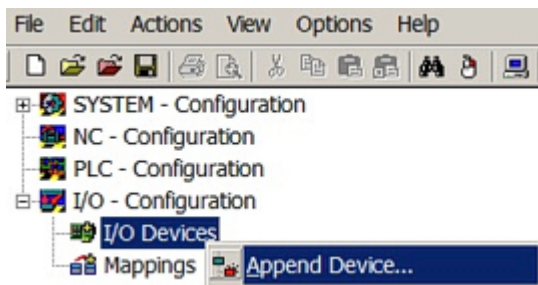

Fig. 48: Append EtherCAT device

Select type ‘EtherCAT’ for an EtherCAT I/O application with EtherCAT slaves. For the present publisher/subscriber service in combination with an EL6601/EL6614 terminal select “EtherCAT Automation Protocol via EL6601”.

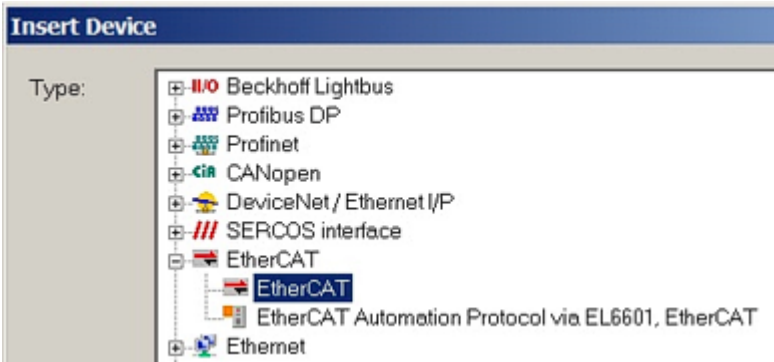

Fig. 49: Selecting the EtherCAT connection (TwinCAT 2.11)

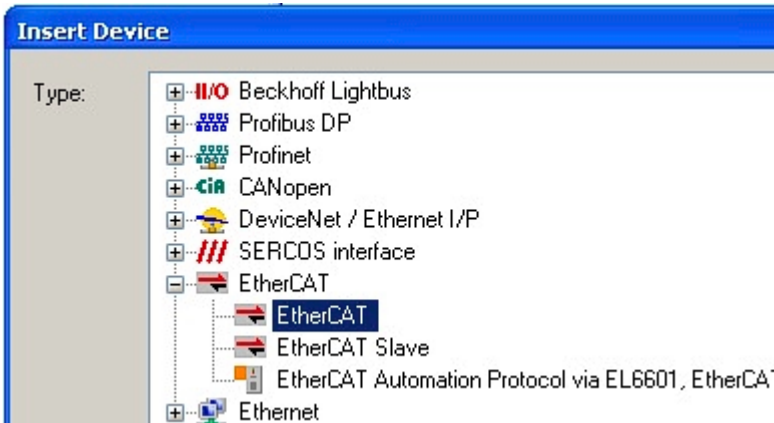

Fig. 50: Selecting the EtherCAT connection (TwinCAT 2.11 R2)

Then assign a real Ethernet port to this virtual device in the runtime system.

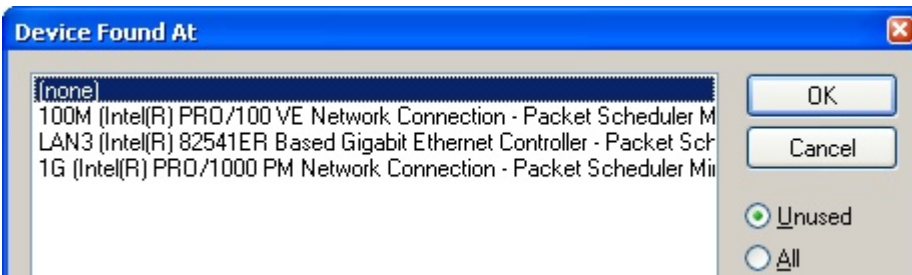

Fig. 51: Selecting the Ethernet port

This query may appear automatically when the EtherCAT device is created, or the assignment can be set/modified later in the properties dialog (see Fig. "EtherCAT properties dialog").

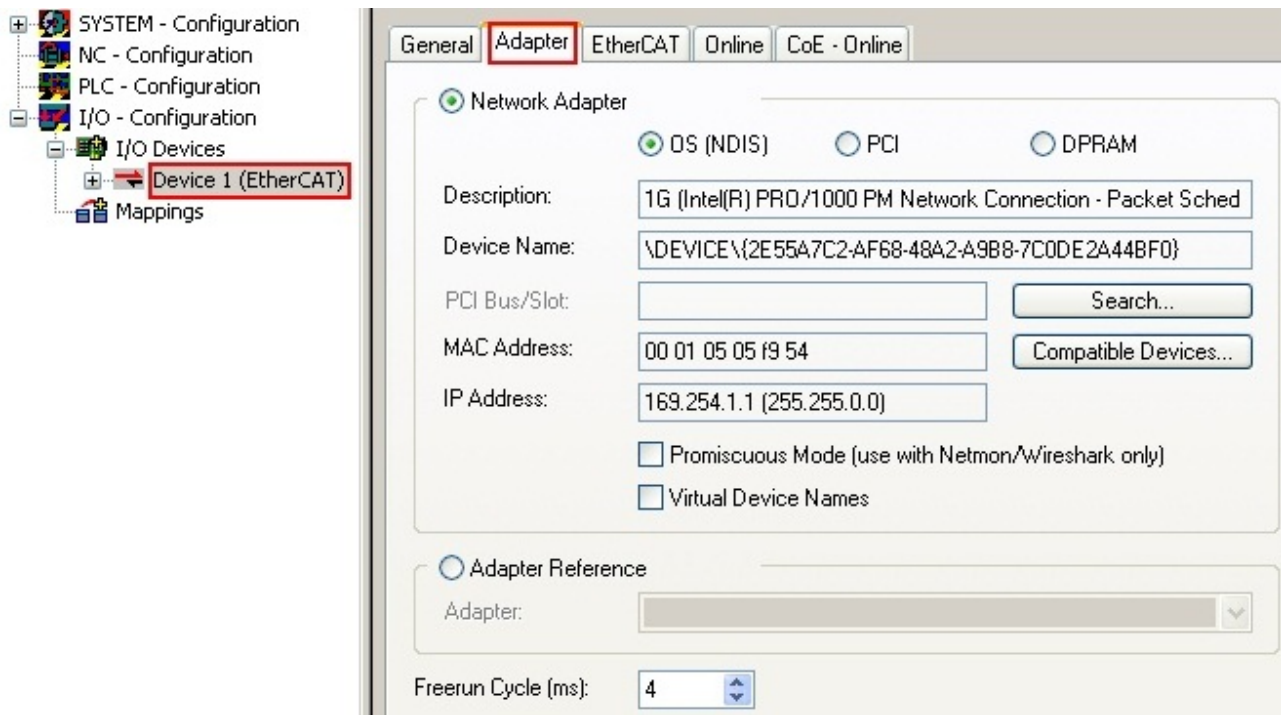



Fig. 52: EtherCAT properties dialog

 Note	<p>Selecting the Ethernet port</p> <p>Ethernet ports can only be selected for EtherCAT devices for which the TwinCAT real-time driver is installed. This has to be done separately for each port. Please refer to the respective installation page.</p>
---	--

Defining EtherCAT slaves

Further devices can be appended by right-clicking on a device in the configuration tree.

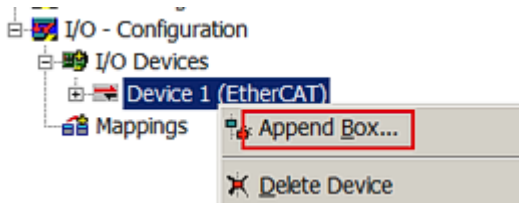

Fig. 53: Appending EtherCAT devices

The dialog for selecting a new device opens. Only devices for which ESI files are available are displayed.

Only devices are offered for selection that can be appended to the previously selected device. Therefore the physical layer available for this port is also displayed (Fig. "Selection dialog for new EtherCAT device", A). In the case of cable-based Fast-Ethernet physical layer with PHY transfer, then also only cable-based devices are available, as shown in Fig. "Selection dialog for new EtherCAT device". If the preceding device has several free ports (e.g. EK1122 or EK1100), the required port can be selected on the right-hand side (A).

Overview of physical layer

- "Ethernet": cable-based 100BASE-TX: EK couplers, EP boxes, devices with RJ45/M8/M12 connector
- "E-Bus": LVDS "terminal bus": EL/ES terminals, various modular modules

The search field facilitates finding specific devices (TwinCAT 2.11 or higher).

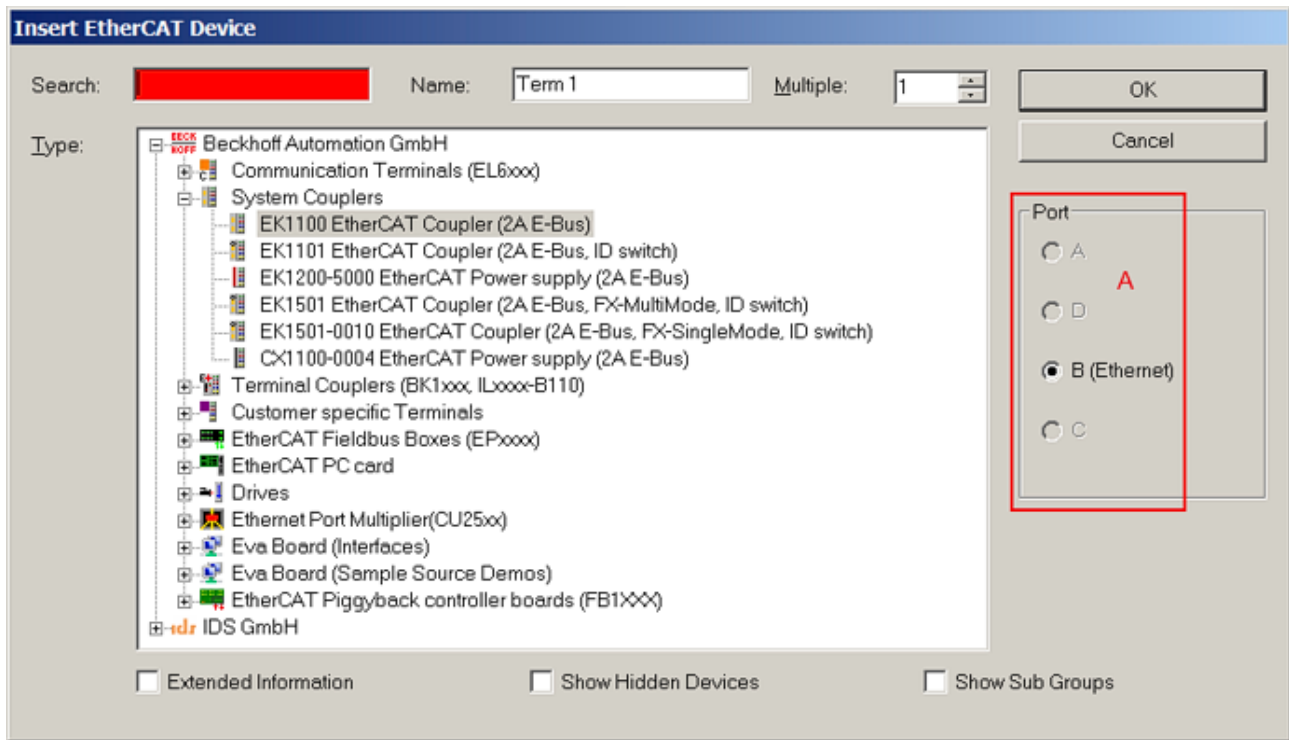

Fig. 54: Selection dialog for new EtherCAT device

By default only the name/device type is used as selection criterion. For selecting a specific revision of the device the revision can be displayed as “Extended Information”.

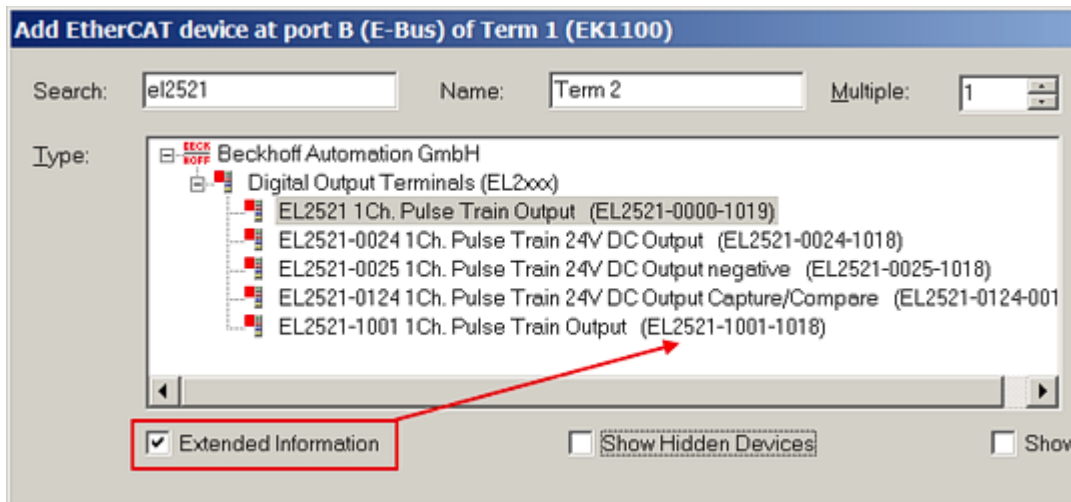

Fig. 55: Display of device revision

In many cases several device revisions were created for historic or functional reasons, e.g. through technological advancement. For simplification purposes (see Fig. “Selection dialog for new EtherCAT device”) only the last (i.e. highest) revision and therefore the latest state of production is displayed in the selection dialog for Beckhoff devices. To show all device revisions available in the system as ESI descriptions tick the “Show Hidden Devices” check box, see Fig. “Display of previous revisions”.

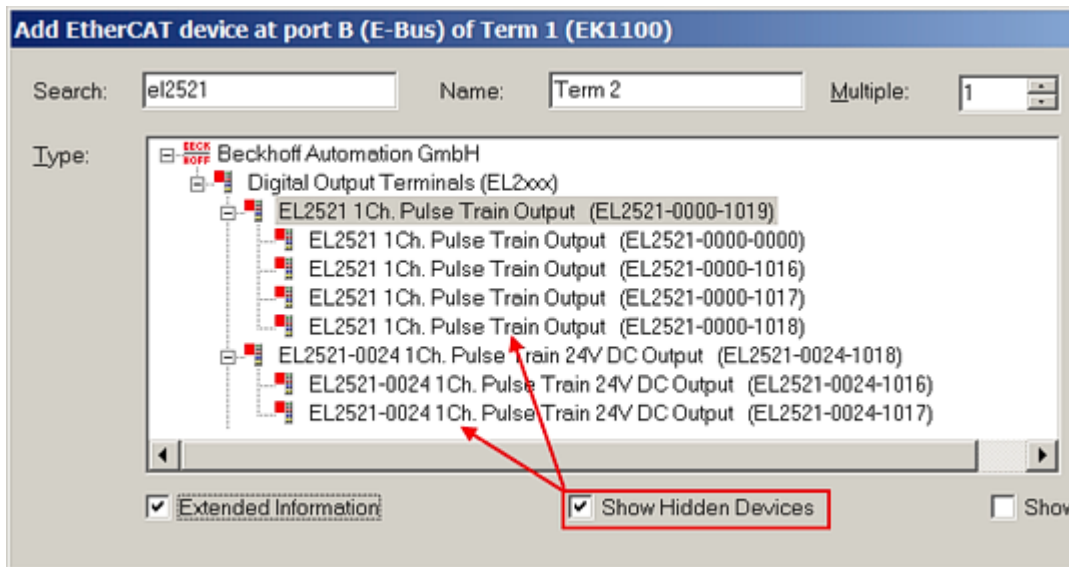

Fig. 56: Display of previous revisions



Note

Device selection based on revision, compatibility

The ESI description also defines the process image, the communication type between master and slave/device and the device functions, if applicable. The physical device (firmware, if available) has to support the communication queries/settings of the master. This is backward compatible, i.e. newer devices (higher revision) should be supported if the EtherCAT master addresses them as an older revision. The following compatibility rule of thumb is to be assumed for Beckhoff EtherCAT Terminals/Boxes:

device revision in the system \geq device revision in the configuration

This also enables subsequent replacement of devices without changing the configuration (different specifications are possible for drives).

Example:

If an EL2521-0025-**1018** is specified in the configuration, an EL2521-0025-**1018** or higher (**-1019**, **-1020**) can be used in practice.

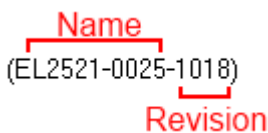

Fig. 57: Name/revision of the terminal

If current ESI descriptions are available in the TwinCAT system, the last revision offered in the selection dialog matches the Beckhoff state of production. It is recommended to use the last device revision when creating a new configuration, if current Beckhoff devices are used in the real application. Older revisions should only be used if older devices from stock are to be used in the application.

In this case the process image of the device is shown in the configuration tree and can be parameterised as follows: linking with the task, CoE/DC settings, plug-in definition, startup settings, ...

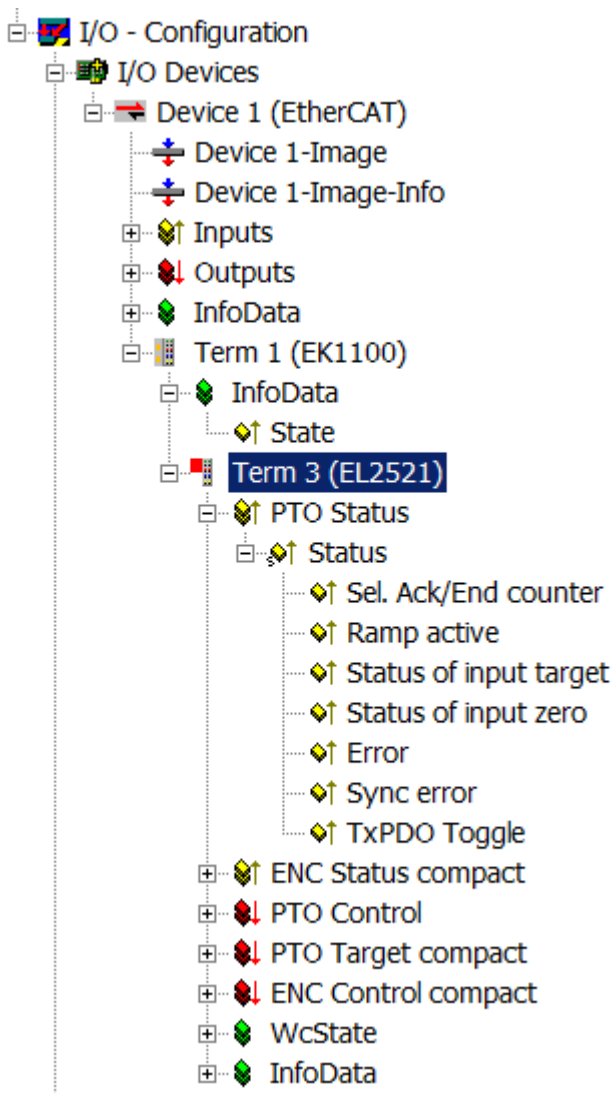

Fig. 58: EtherCAT terminal in the TwinCAT tree

6.1.4 Online configuration creation ‘scanning’ (master: TwinCAT 2.x)

Distinction between Online and Offline

Distinction between Online and Offline

The distinction between online and offline refers to the presence of the actual I/O environment (drives, terminals). If the configuration is to be prepared in advance of the system configuration as a programming system, e.g. on a laptop, this is only possible in “Offline configuration” mode. In this case all components have to be entered manually in the configuration, e.g. based on the electrical design.

If the designed control system is already connected to the EtherCAT system and all components are energised and the infrastructure is ready for operation, the TwinCAT configuration can simply be generated through “scanning” from the runtime system. This is referred to as online configuration.

In any case, during each startup the EtherCAT master checks whether the slaves it finds match the configuration. This test can be parameterised in the extended slave settings.



Note

Installation of the latest ESI-XML device description

The TwinCAT EtherCAT master/System Manager needs the device description files for the devices to be used in order to generate the configuration in online or offline mode. The device descriptions are contained in the so-called ESI files (EtherCAT Slave Information) in XML format. These files can be requested from the respective manufacturer and are made available for download. The ESIs for Beckhoff EtherCAT devices are provided on the Beckhoff website. The ESI files should be saved in the TwinCAT installation directory (default: C:\TwinCAT\IO\EtherCAT). The files are read (once) when a new System Manager window is opened. A TwinCAT installation includes the set of Beckhoff ESI files that was current at the time when the TwinCAT build was created.

For TwinCAT 2.11 and higher, the ESI directory can be updated from the System Manager, if the programming PC is connected to the Internet (Option -> “Update EtherCAT Device Descriptions”)

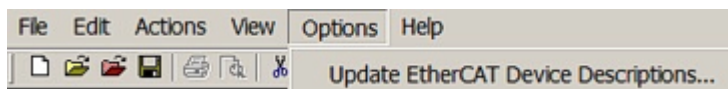

Fig. 59: Updating ESI directory

The following conditions must be met before a configuration can be set up:

- the real EtherCAT hardware (devices, couplers, drives) must be present and installed
- the devices/modules must be connected via EtherCAT cables or in the terminal strand in the same way as they are intended to be used later
- the devices/modules be connected to the power supply and ready for communication
- TwinCAT must be in CONFIG mode on the target system.

The online scan process consists of:

- [detecting the EtherCAT device \[▶ 66\]](#) (Ethernet port at the IPC)
- [detecting the connected EtherCAT devices \[▶ 68\]](#). This step can be carried out independent of the preceding step
- [troubleshooting \[▶ 71\]](#)

The [scan with existing configuration \[▶ 72\]](#) can also be carried out for comparison.

Detecting/scanning of the EtherCAT device

The online device search can be used if the TwinCAT system is in CONFIG mode (blue TwinCAT icon or blue indication in the System Manager).

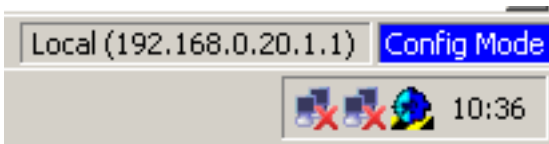



Fig. 60: TwinCAT CONFIG mode display

 Note	<p>Online scanning in Config mode</p> <p>The online search is not available in RUN mode (production operation). Note the differentiation between TwinCAT programming system and TwinCAT target system.</p>
--	---

The TwinCAT icon next to the Windows clock always shows the TwinCAT mode of the local IPC. The System Manager window shows the TwinCAT state of the target system.

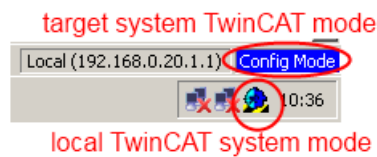

Fig. 61: Differentiation local/target system

Right-clicking on “I/O Devices” in the configuration tree opens the search dialog.

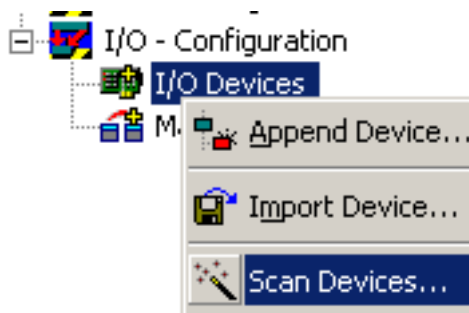

Fig. 62: Scan Devices

This scan mode attempts to find not only EtherCAT devices (or Ethernet ports that are usable as such), but also NOVRAM, fieldbus cards, SMB etc. However, not all devices can be found automatically.

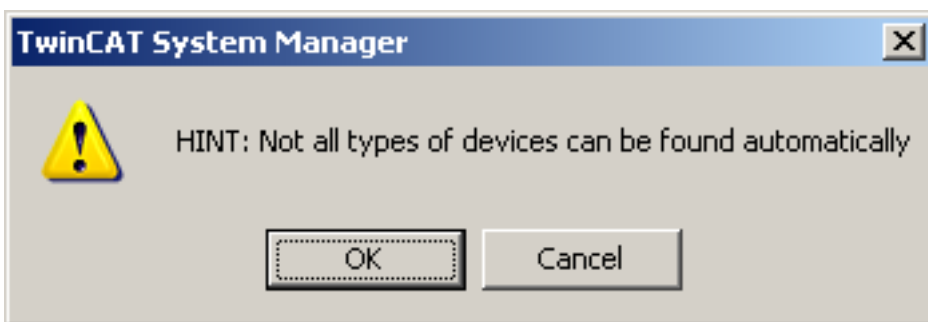

Fig. 63: Note for automatic device scan

Ethernet ports with installed TwinCAT real-time driver are shown as “RT Ethernet” devices. An EtherCAT frame is sent to these ports for testing purposes. If the scan agent detects from the response that an EtherCAT slave is connected, the port is immediately shown as an “EtherCAT Device” .

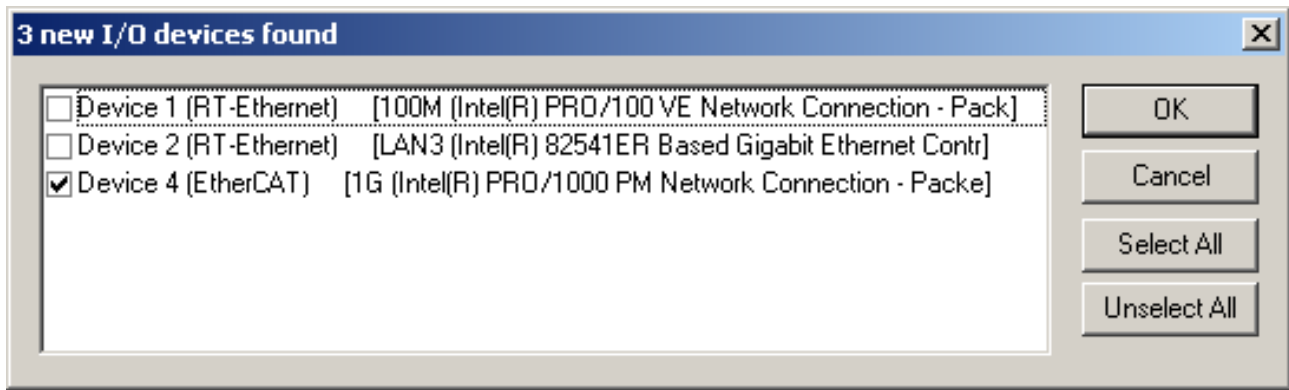



Fig. 64: Detected Ethernet devices

After confirmation with “OK” a device scan is suggested for all selected devices, see Fig. 5.

 Note	<p>Selecting the Ethernet port</p> <p>Ethernet ports can only be selected for EtherCAT devices for which the TwinCAT real-time driver is installed. This has to be done separately for each port. Please refer to the respective installation page ▶ 52.</p>
--	---

Detecting/Scanning the EtherCAT devices

 Note	<p>Online scan functionality</p> <p>During a scan the master queries the identity information of the EtherCAT slaves from the slave EEPROM. The name and revision are used for determining the type. The respective devices are located in the stored ESI data and integrated in the configuration tree in the default state defined there.</p>
--	--

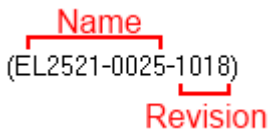



Fig. 65: Example default state

 Attention	<p>Slave scanning in practice in series machine production</p> <p>The scanning function should be used with care. It is a practical and fast tool for creating an initial configuration as a basis for commissioning. In series machine production or reproduction of the plant, however, the function should no longer be used for the creation of the configuration, but if necessary for comparison ▶ 72 with the defined initial configuration. Background: since Beckhoff occasionally increases the revision version of the delivered products for product maintenance reasons, a configuration can be created by such a scan which (with an identical machine construction) is identical according to the device list; however, the respective device revision may differ from the initial configuration.</p>
---	---

Example:

Company A builds the prototype of a machine B, which is to be produced in series later on. To do this the prototype is built, a scan of the IO devices is performed in TwinCAT and the initial configuration ‘B.tsm’ is created. The EL2521-0025 EtherCAT terminal with the revision 1018 is located somewhere. It is thus built into the TwinCAT configuration in this way:

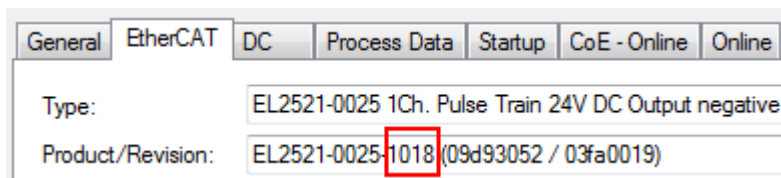

Fig. 66: Installing EtherCAT terminal with revision -1018

Likewise, during the prototype test phase, the functions and properties of this terminal are tested by the programmers/commissioning engineers and used if necessary, i.e. addressed from the PLC 'B.pro' or the NC. (the same applies correspondingly to the TwinCAT3 solution files).

The prototype development is now completed and series production of machine B starts, for which Beckhoff continues to supply the EL2521-0025-0018. If the commissioning engineers of the series machine production department always carry out a scan, a B configuration with the identical contents results again for each machine. Likewise, A might create spare parts stores worldwide for the coming series-produced machines with EL2521-0025-1018 terminals.

After some time Beckhoff extends the EL2521-0025 by a new feature C. Therefore the FW is changed, outwardly recognizable by a higher FW version and a **new revision -1019**. Nevertheless the new device naturally supports functions and interfaces of the predecessor version(s); an adaptation of 'B.tsm' or even 'B.pro' is therefore unnecessary. The series-produced machines can continue to be built with 'B.tsm' and 'B.pro'; it makes sense to perform a comparative scan [▶ 72](#) against the initial configuration 'B.tsm' in order to check the built machine.

However, if the series machine production department now doesn't use 'B.tsm', but instead carries out a scan to create the productive configuration, the revision **-1019** is automatically detected and built into the configuration:

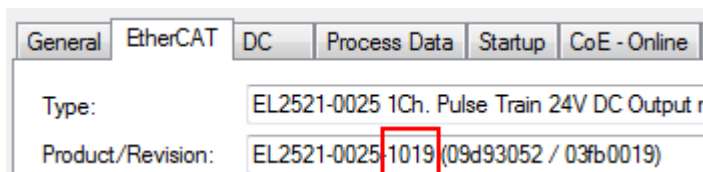

Fig. 67: Detection of EtherCAT terminal with revision -1019

This is usually not noticed by the commissioning engineers. TwinCAT cannot signal anything either, since virtually a new configuration is created. According to the compatibility rule, however, this means that no EL2521-0025-1018 should be built into this machine as a spare part (even if this nevertheless works in the vast majority of cases).

In addition, it could be the case that, due to the development accompanying production in company A, the new feature C of the EL2521-0025-1019 (for example, an improved analog filter or an additional process data for the diagnosis) is discovered and used without in-house consultation. The previous stock of spare part devices are then no longer to be used for the new configuration 'B2.tsm' created in this way. If series machine production is established, the scan should only be performed for informative purposes for comparison with a defined initial configuration. Changes are to be made with care!

If an EtherCAT device was created in the configuration (manually or through a scan), the I/O field can be scanned for devices/slaves.

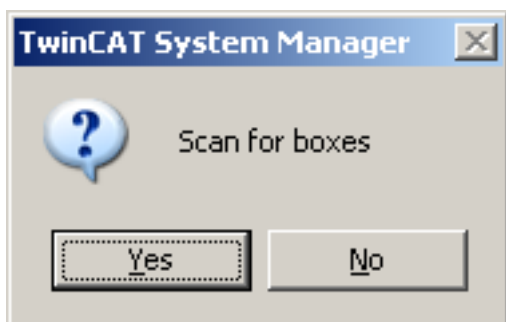

Fig. 68: Scan query after automatic creation of an EtherCAT device

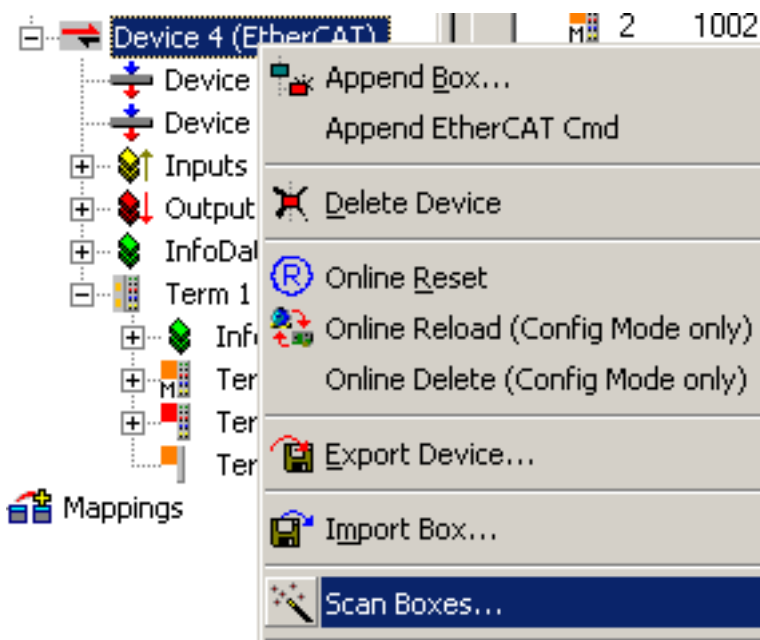

Fig. 69: Manual triggering of a device scan on a specified EtherCAT device

In the System Manager the scan process can be monitored via the progress bar at the bottom of the screen.



Fig. 70: Scan progress

The configuration is established and can then be switched to online state (OPERATIONAL).



Fig. 71: Config/FreeRun query

In Config/FreeRun mode the System Manager display alternates between blue and red, and the EtherCAT device continues to operate with the idling cycle time of 4 ms (default setting), even without active task (NC, PLC).

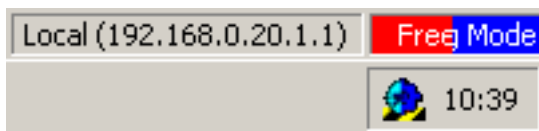

Fig. 72: Config/FreeRun indicator



Fig. 73: TwinCAT kann auch durch einen Button in diesen Zustand versetzt werden

The EtherCAT system should then be in a functional cyclic state, as shown in Fig. "Online display example".

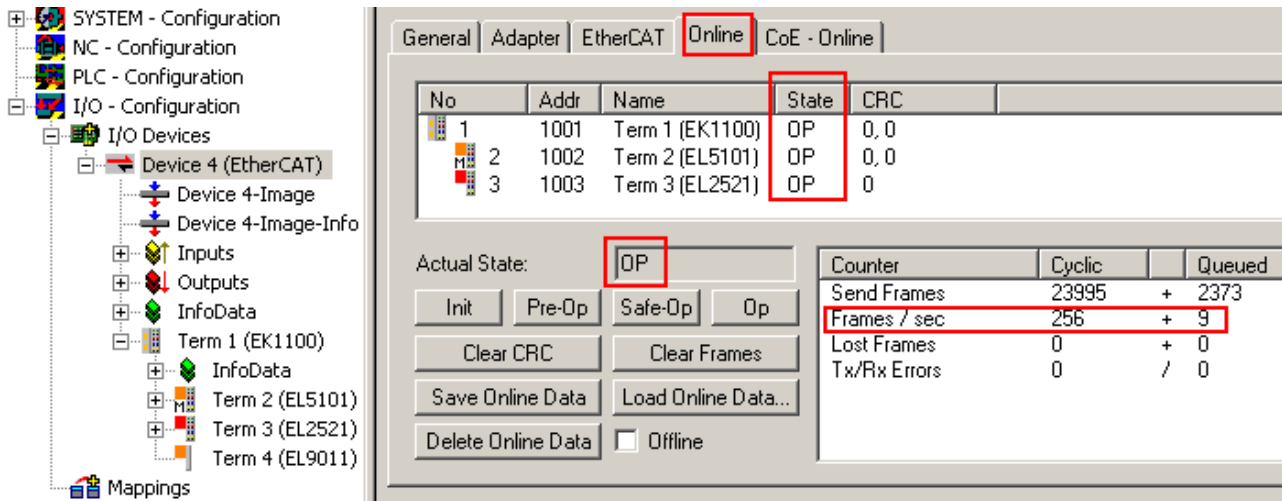

Fig. 74: Online display example

Please note:

- all slaves should be in OP state
- the EtherCAT master should be in "Actual State" OP
- "frames/sec" should match the cycle time taking into account the sent number of frames
- no excessive "LostFrames" or CRC errors should occur

The configuration is now complete. It can be modified as described under manual procedure [▶ 60].

Troubleshooting

Various effects may occur during scanning.

- An **unknown device** is detected, i.e. an EtherCAT slave for which no ESI XML description is available. In this case the System Manager offers to read any ESI that may be stored in the device. This case is described in the chapter "Notes regarding ESI device description".
- **Device are not detected properly**
Possible reasons include:
 - faulty data links, resulting in data loss during the scan
 - slave has invalid device description
 The connections and devices should be checked in a targeted manner, e.g. via the emergency scan. Then re-run the scan.

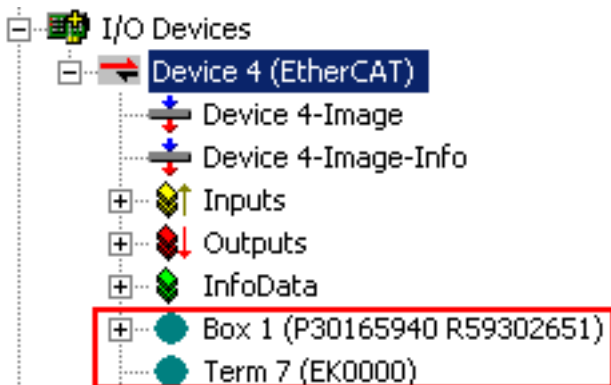



Fig. 75: Faulty identification

In the System Manager such devices may be set up as EK0000 or unknown devices. Operation is not possible or meaningful.

Scan over existing Configuration

 Attention	<p>Change of the configuration after comparison</p> <p>With this scan (TwinCAT 2.11 or 3.1) only the device properties vendor (manufacturer), device name and revision are compared at present! A 'ChangeTo' or 'Copy' should only be carried out with care, taking into consideration the Beckhoff IO compatibility rule (see above). The device configuration is then replaced by the revision found; this can affect the supported process data and functions.</p>
---	--

If a scan is initiated for an existing configuration, the actual I/O environment may match the configuration exactly or it may differ. This enables the configuration to be compared.



Fig. 76: Identical configuration

If differences are detected, they are shown in the correction dialog, so that the user can modify the configuration as required.

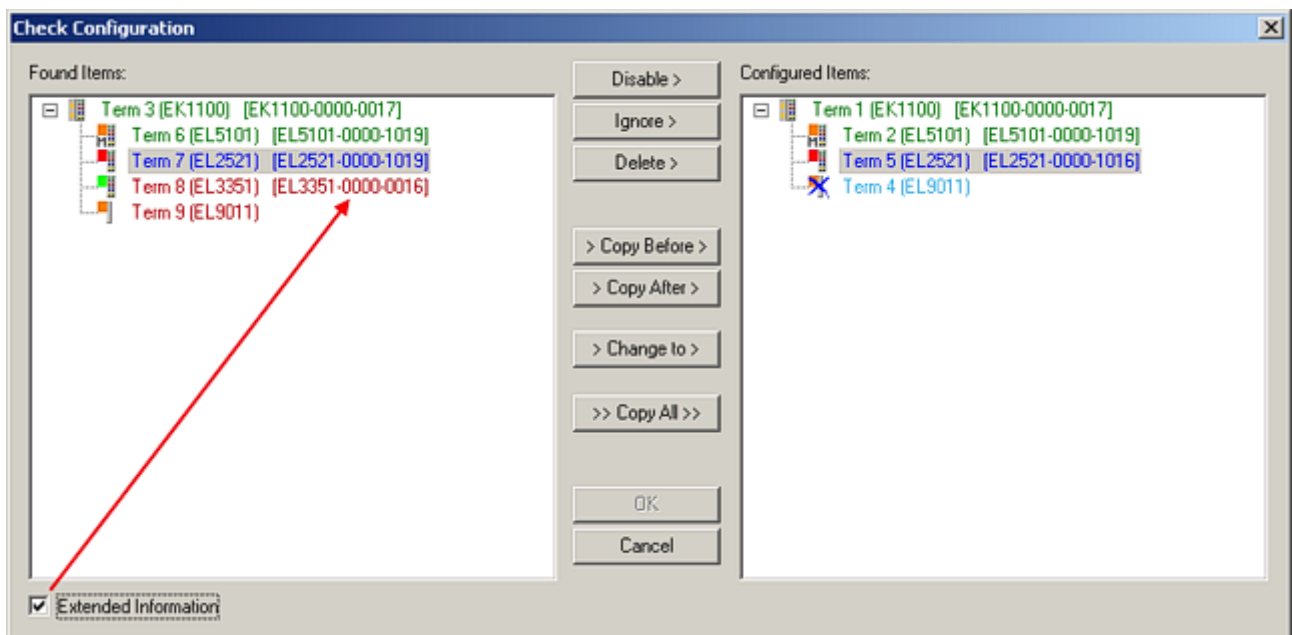



Fig. 77: Correction dialog

It is advisable to tick the “Extended Information” check box to reveal differences in the revision.

Colour	Explanation
green	This EtherCAT slave matches the entry on the other side. Both type and revision match.
blue	This EtherCAT slave is present on the other side, but in a different revision. This other revision can have other default values for the process data as well as other/additional functions. If the found revision is higher than the configured revision, the slave may be used provided compatibility issues are taken into account. If the found revision is lower than the configured revision, it is likely that the slave cannot be used. The found device may not support all functions that the master expects based on the higher revision number.
light blue	This EtherCAT slave is ignored ("Ignore" button)
red	<ul style="list-style-type: none"> This EtherCAT slave is not present on the other side. It is present, but in a different revision, which also differs in its properties from the one specified. The compatibility principle then also applies here: if the found revision is higher than the configured revision, use is possible provided compatibility issues are taken into account, since the successor devices should support the functions of the predecessor devices. If the found revision is lower than the configured revision, it is likely that the slave cannot be used. The found device may not support all functions that the master expects based on the higher revision number.

 Note	<p>Device selection based on revision, compatibility</p> <p>The ESI description also defines the process image, the communication type between master and slave/device and the device functions, if applicable. The physical device (firmware, if available) has to support the communication queries/settings of the master. This is backward compatible, i.e. newer devices (higher revision) should be supported if the EtherCAT master addresses them as an older revision. The following compatibility rule of thumb is to be assumed for Beckhoff EtherCAT Terminals/Boxes:</p> <p>device revision in the system >= device revision in the configuration</p> <p>This also enables subsequent replacement of devices without changing the configuration (different specifications are possible for drives).</p>
--	---

Example:

If an EL2521-0025-1018 is specified in the configuration, an EL2521-0025-1018 or higher (-1019, -1020) can be used in practice.

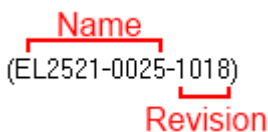

Fig. 78: Name/revision terminal

If current ESI descriptions are available in the TwinCAT system, the last revision offered in the selection dialog matches the Beckhoff state of production. It is recommended to use the last device revision when creating a new configuration, if current Beckhoff devices are used in the real application. Older revisions should only be used if older devices from stock are to be used in the application.

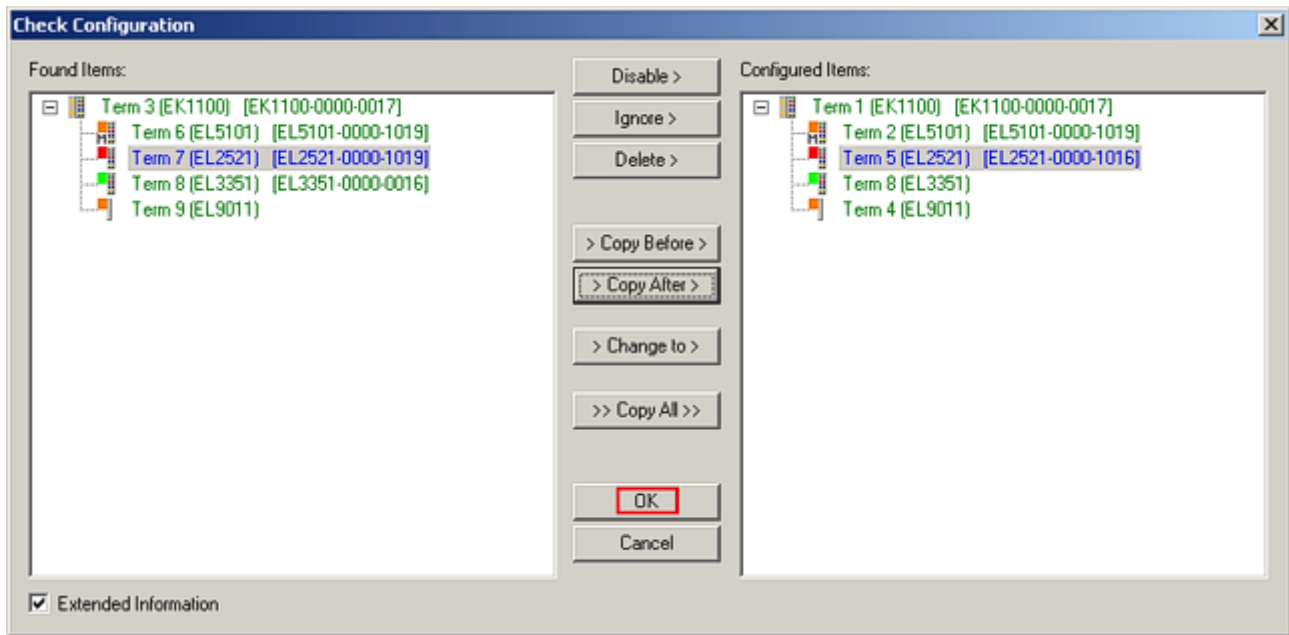

Fig. 79: Correction dialog with modifications

Once all modifications have been saved or accepted, click “OK” to transfer them to the real *.tsm configuration.

Change to compatible device

The TwinCAT System Manager offers a function for the exchange of a device whilst retaining the links in the task: *Change to compatible device*.

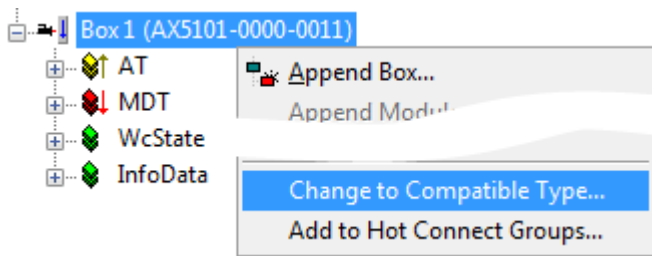

Fig. 80: TwinCAT 2 Dialog ChangeToCompatibleDevice

This function is preferably to be used on AX5000 devices. If called, the System Manager suggests the devices that it finds in the associated sub-folder; in the case of the AX5000, for example, in `\TwinCAT\IO\EtherCAT\Beckhoff AX5xxx`.

Change to Alternative Type

The TwinCAT System Manager offers a function for the exchange of a device: *Change to Alternative Type*

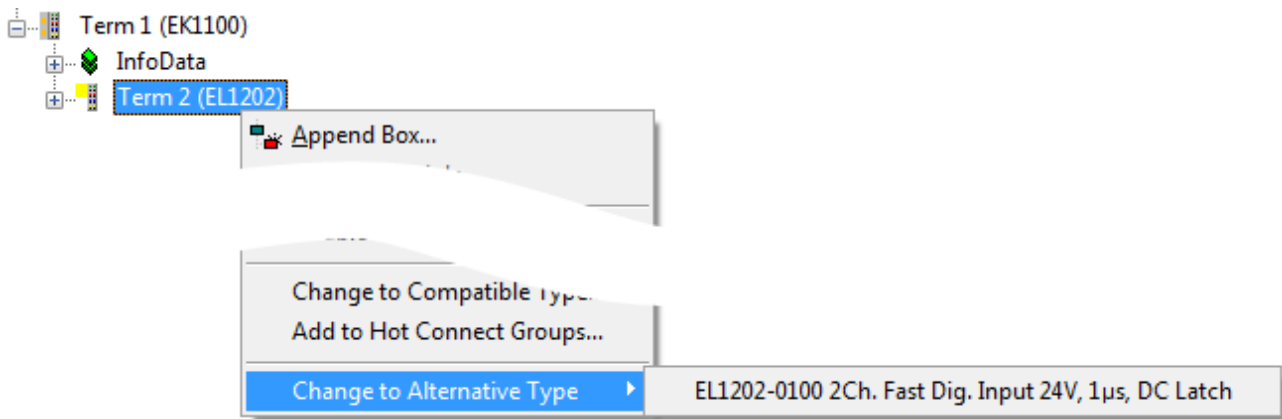

Fig. 81: TwinCAT 2 Dialog ChangeToCompatibleDevice

If called, the System Manager searches in the procured device ESI (in this example: EL1202-0000) for details of compatible devices contained there. The configuration is changed and the ESI-EEPROM is overwritten at the same time – therefore this process is possible only in the online state (ConfigMode).

6.1.5 EtherCAT slave process data settings

The process data transferred by an EtherCAT slave during each cycle (**Process Data Objects, PDOs**) are user data which the application expects to be updated cyclically or which are sent to the slave. To this end the EtherCAT master (Beckhoff TwinCAT) parameterizes each EtherCAT slave during the start-up phase to define which process data (size in bits/bytes, source location, transmission type) it wants to transfer to or from this slave. Incorrect configuration can prevent successful start-up of the slave.

For Beckhoff EtherCAT EL/ES slaves the following applies in general:

- The input/output process data supported by the device are defined by the manufacturer in the ESI/XML description. The TwinCAT EtherCAT Master uses the ESI description to configure the slave correctly.
- The process data can be modified in the system manager. See the device documentation. Examples of modifications include: mask out a channel, displaying additional cyclic information, 16-bit display instead of 8-bit data size, etc.
- In so-called “intelligent” EtherCAT devices the process data information is also stored in the CoE directory. Any changes in the CoE directory that lead to different PDO settings prevent successful startup of the slave. It is not advisable to deviate from the designated process data, because the device firmware (if available) is adapted to these PDO combinations.

If the device documentation allows modification of process data, proceed as follows (see Figure “*Configuring the process data*”).

- A: select the device to configure
- B: in the “Process Data” tab select Input or Output under SyncManager (C)
- D: the PDOs can be selected or deselected
- H: the new process data are visible as linkable variables in the system manager
The new process data are active once the configuration has been activated and TwinCAT has been restarted (or the EtherCAT master has been restarted)
- E: if a slave supports this, Input and Output PDO can be modified simultaneously by selecting a so-called PDO record (“predefined PDO settings”).

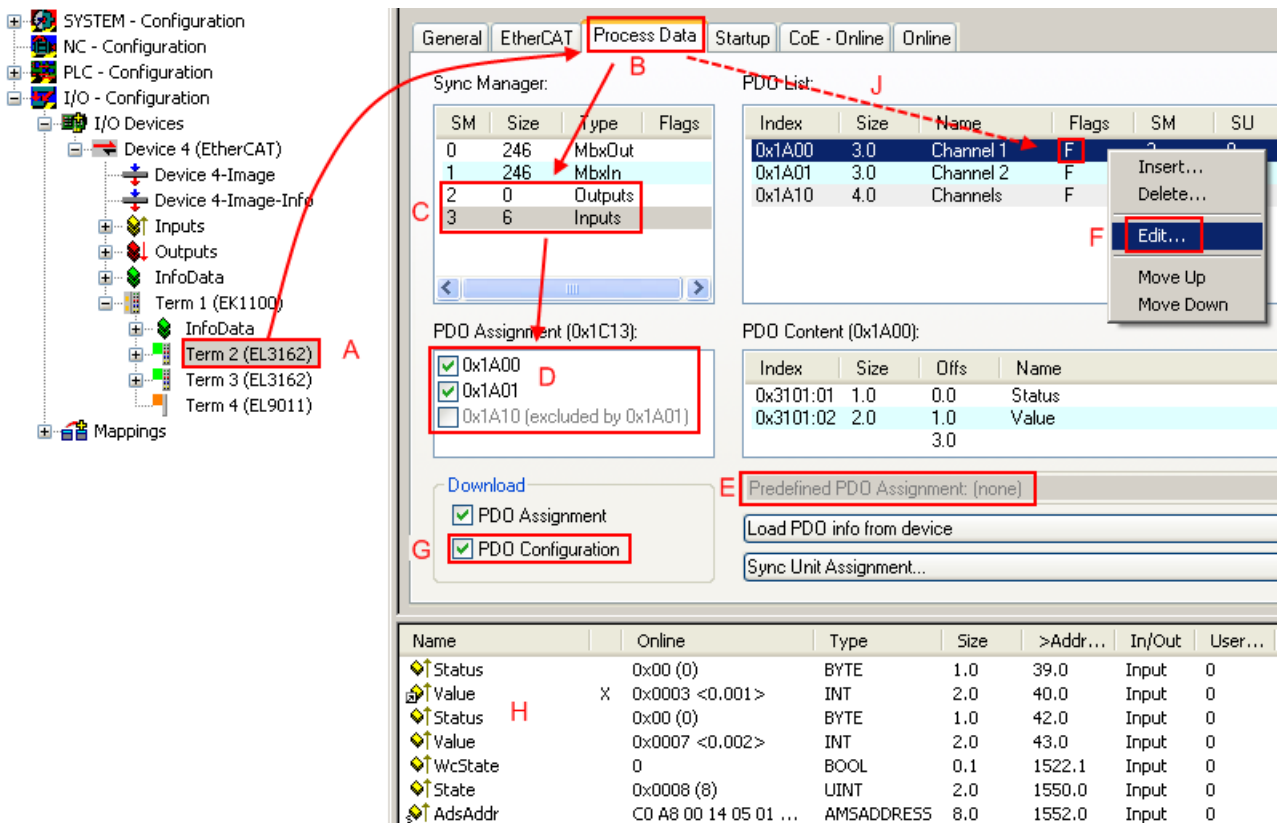

Fig. 82: Configuring the process data



Note

Manual modification of the process data

According to the ESI description, a PDO can be identified as “fixed” with the flag “F” in the PDO overview (Fig. “Configuring the process data”, J). The configuration of such PDOs cannot be changed, even if TwinCAT offers the associated dialog (“Edit”). In particular, CoE content cannot be displayed as cyclic process data. This generally also applies in cases where a device supports download of the PDO configuration, “G”. In case of incorrect configuration the EtherCAT slave usually refuses to start and change to OP state. The System Manager displays an “invalid SM cfg” logger message: This error message (“invalid SM IN cfg” or “invalid SM OUT cfg”) also indicates the reason for the failed start.

6.1.6 Configuration with the TwinCAT System Manager - digital input and output terminals

(with TwinCAT from version 2.10.0 (build 1305), example based on EL1014)

Click in the left-hand window of the TwinCAT System Manager on the tree branch of the terminal that you wish to configure (in the example: terminal 4 EL1014).

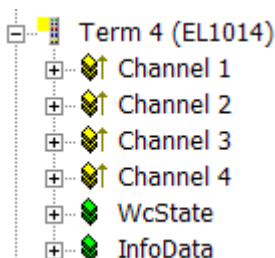

In the right-hand window of the TwinCAT System Manager, various tabs are now available for configuring the terminal.

General tab

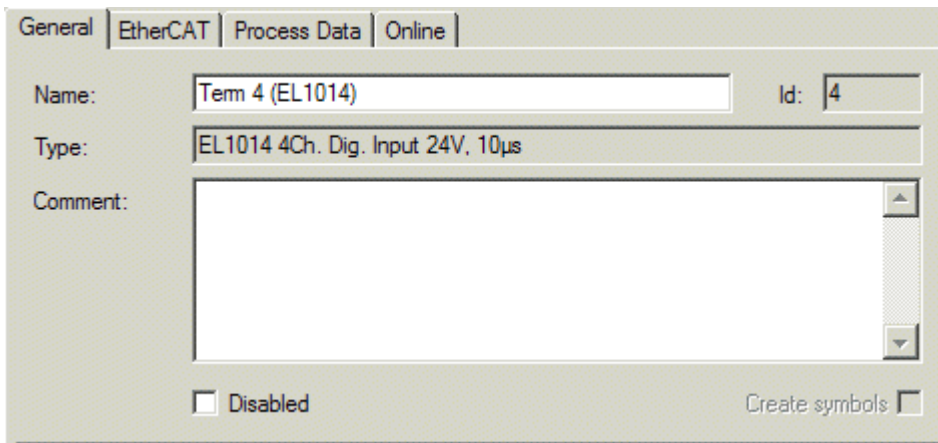

Fig. 83: General tab

Name	Name of the EtherCAT device
Id	Number of the EtherCAT device
Type	EtherCAT device type
Comment	Here you can add a comment (e.g. regarding the system).
Disabled	Here you can deactivate the EtherCAT device.
Create symbols	Access to this EtherCAT slave via ADS is only available if this control box is activated.

EtherCAT tab

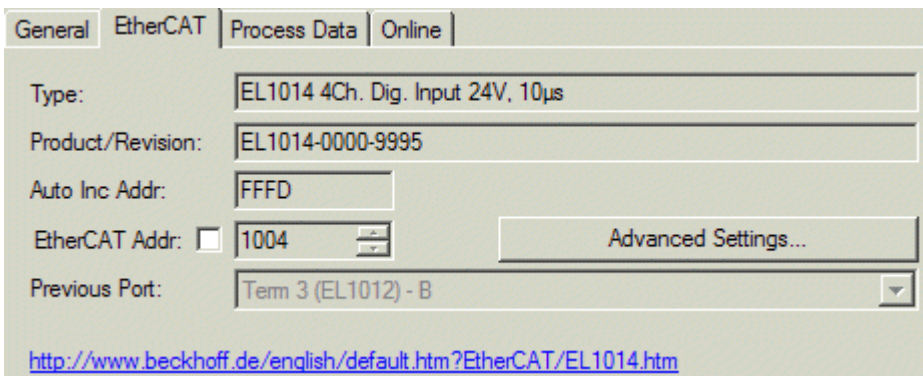

Fig. 84: EtherCAT tab

- Type** EtherCAT device type
- Product/Revision** Product and revision number of the EtherCAT device
- Auto Inc Addr.** Auto increment address of the EtherCAT device. The auto increment address can be used for addressing each EtherCAT device in the communication ring through its physical position. Auto increment addressing is used during the start-up phase when the EtherCAT master allocates addresses to the EtherCAT devices. With auto increment addressing the first EtherCAT slave in the ring has the address 0000_{hex} . For each further slave the address is decremented by 1 ($FFFF_{hex}$, $FFFE_{hex}$ etc.).
- EtherCAT Addr.** Fixed address of an EtherCAT slave. This address is allocated by the EtherCAT master during the start-up phase. Tick the control box to the left of the input field in order to modify the default value.
- Previous Port** Name and port of the EtherCAT device to which this device is connected. If it is possible to connect this device with another one without changing the order of the EtherCAT devices in the communication ring, then this combination field is activated and the EtherCAT device to which this device is to be connected can be selected.
- Advanced Settings** This button opens the dialogs for advanced settings.

The link at the bottom of the tab points to the product page for this EtherCAT device on the web.

Process Data tab

Indicates the configuration of the process data. The input and output data of the EtherCAT slave are represented as CANopen process data objects (PDO). Digital input terminals (EL10xx) and digital output terminals (EL20xx) feature a fixed PDO allocation.

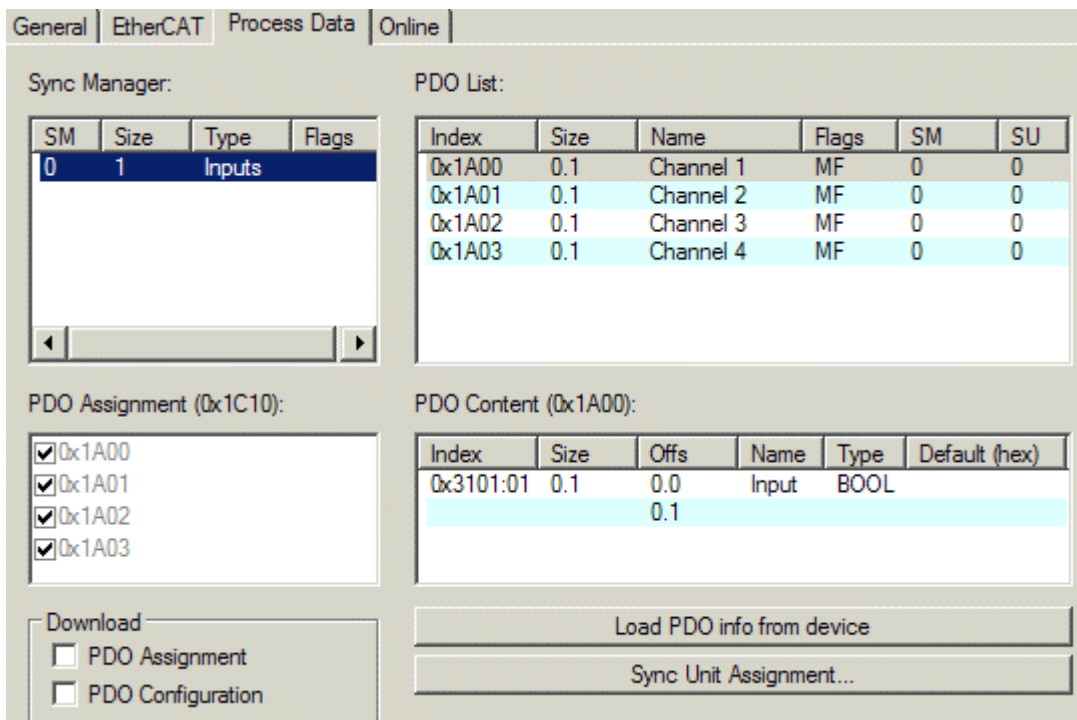

Fig. 85: Process Data tab

Sync Manager

Lists the configuration of the Sync Manager (SM). The corresponding PDO Assignment is displayed in the *PDO Assignment* list below.

PDO Assignment

PDO assignment of the selected Sync Manager. All PDOs defined for this Sync Manager type are listed here.

The selected entries are the PDOs involved in the process data transfer. In the tree diagram of the System Manager these PDOs are displayed as variables of the EtherCAT device. The name of the variable is identical to the *Name* parameter of the PDO, as displayed in the PDO list.

PDO list

List of all PDOs supported by this EtherCAT device. The content of the selected PDOs is displayed in the *PDO Content* list. The PDO configuration can be modified by double-clicking on an entry.

Column	Description	
Index	PDO index.	
Size	Size of the PDO in bytes.	
Name	Name of the PDO. If this PDO is assigned to a Sync Manager, it appears as a variable of the slave with this parameter as the name.	
Flags	F	Fixed content: The content of this PDO is fixed and cannot be changed by the System Manager.
	M	Mandatory PDO. This PDO is mandatory and must therefore be assigned to a Sync Manager! Consequently, this PDO cannot be deleted from the <i>PDO Assignment</i> list
SM	Sync Manager to which this PDO is assigned. If this entry is empty, this PDO does not take part in the process data traffic.	
SU	Sync unit to which this PDO is assigned.	

PDO Content

Indicates the content of the PDO.

Download: PDO assignment, PDO configuration

The download function for the PDO Assignment and configuration is only supported by intelligent terminals.

Online tab

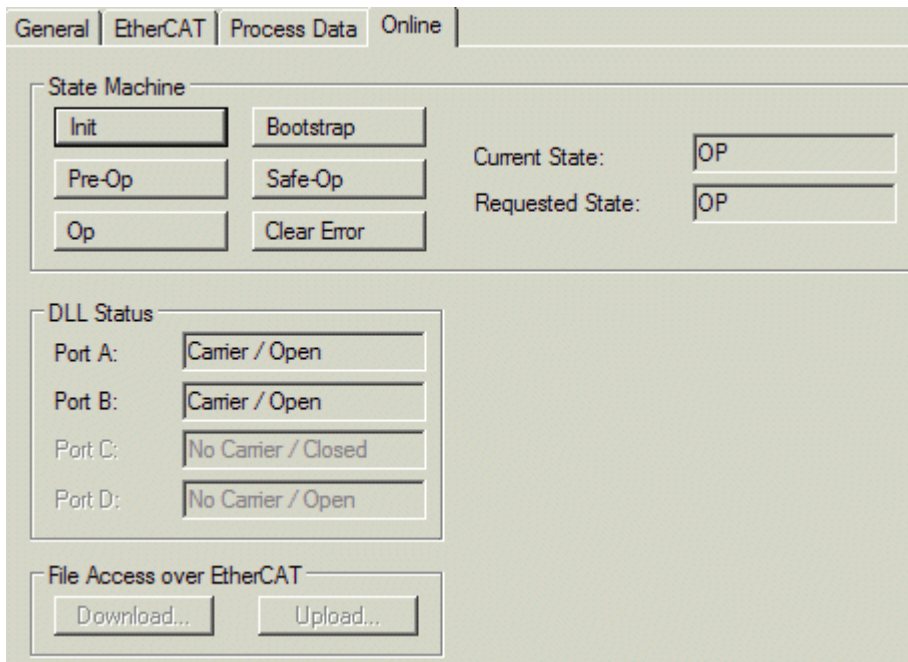

Fig. 86: Online tab

State Machine

- Init** This button attempts to set the EtherCAT device to the *Init* state.
- Pre-Op** This button attempts to set the EtherCAT device to the *pre-operational* state.
- Op** This button attempts to set the EtherCAT device to the *operational* state.
- Bootstrap** This button attempts to set the EtherCAT device to the *Bootstrap* state.
- Safe-Op** This button attempts to set the EtherCAT device to the *safe-operational* state.
- Clear Error** This button attempts to delete the fault display. If an EtherCAT slave fails during change of state it sets an error flag.

Example: An EtherCAT slave is in PREOP state (pre-operational). The master now requests the SAFEOP state (safe-operational). If the slave fails during change of state it sets the error flag. The current state is now displayed as ERR PREOP. When the *Clear Error* button is pressed the error flag is cleared, and the current state is displayed as PREOP again.

- Current State** Indicates the current state of the EtherCAT device.
- Requested State** Indicates the state requested for the EtherCAT device.

DLL Status

Indicates the DLL status (data link layer status) of the individual ports of the EtherCAT slave. The DLL status can have four different states:

Status	Description
No Carrier / Open	No carrier signal is available at the port, but the port is open.
No Carrier / Closed	No carrier signal is available at the port, and the port is closed.
Carrier / Open	A carrier signal is available at the port, and the port is open.
Carrier / Closed	A carrier signal is available at the port, but the port is closed.

Table 1: File Access over EtherCAT

- Download** This is inactive for non-intelligent terminals.
- Upload** This is inactive for non-intelligent terminals.

6.2 General Notes - EtherCAT Slave Application

This summary briefly deals with a number of aspects of EtherCAT Slave operation under TwinCAT. More detailed information on this may be found in the corresponding sections of, for instance, the EtherCAT System Documentation.

Diagnosis in real time: WorkingCounter, EtherCAT State and Status

Generally speaking an EtherCAT Slave provides a variety of diagnostic information that can be used by the controlling task.

This diagnostic information relates to differing levels of communication. It therefore has a variety of sources, and is also updated at various times.

Any application that relies on I/O data from a fieldbus being correct and up to date must make diagnostic access to the corresponding underlying layers. EtherCAT and the TwinCAT System Manager offer comprehensive diagnostic elements of this kind. Those diagnostic elements that are helpful to the controlling task for diagnosis that is accurate for the current cycle when in operation (not during commissioning) are discussed below.

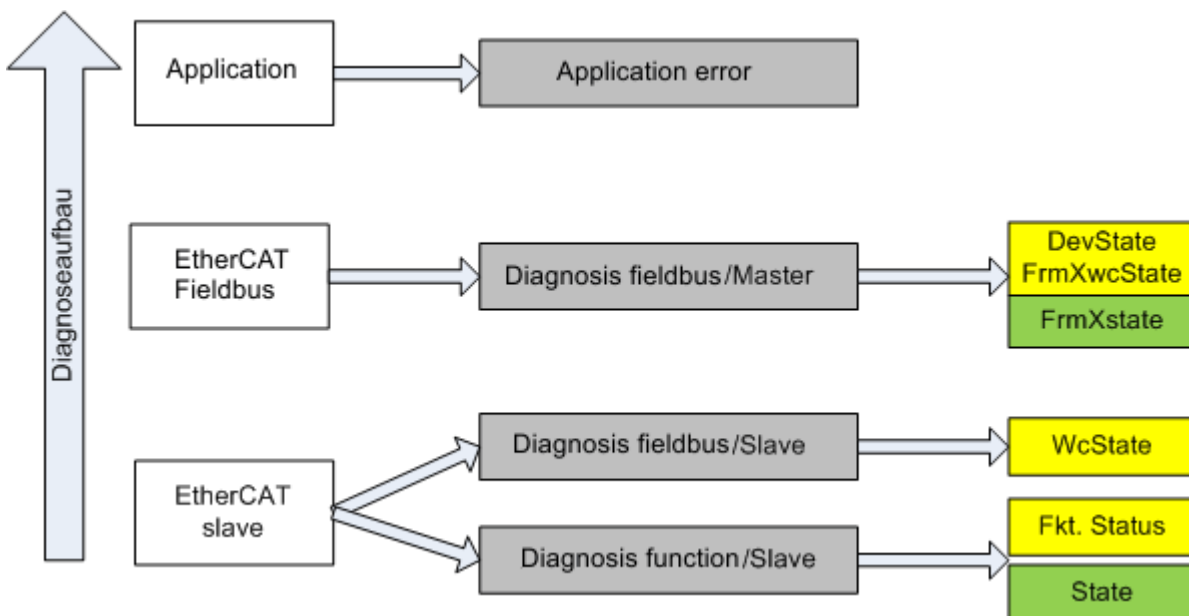

Fig. 87: Selection of the diagnostic information of an EtherCAT Slave

In general, an EtherCAT Slave offers

- communication diagnosis typical for a slave (diagnosis of successful participation in the exchange of process data, and correct operating mode)
This diagnosis is the same for all slaves.

as well as

- function diagnosis typical for a channel (device-dependent)
See the corresponding device documentation

The colors in Fig. "Selection of the diagnostic information of an EtherCAT Slave" also correspond to the variable colors in the System Manager, see Fig. "Basic EtherCAT Slave Diagnosis in the PLC".

Colour	Meaning
yellow	Input variables from the Slave to the EtherCAT Master, updated in every cycle
red	Output variables from the Slave to the EtherCAT Master, updated in every cycle
green	Information variables for the EtherCAT Master that are updated acyclically. This means that it is possible that in any particular cycle they do not represent the latest possible status. It is therefore useful to read such variables through ADS.

Fig. “Basic EtherCAT Slave Diagnosis in the PLC” shows an example of an implementation of basic EtherCAT Slave Diagnosis. A Beckhoff EL3102 (2-channel analogue input terminal) is used here, as it offers both the communication diagnosis typical of a slave and the functional diagnosis that is specific to a channel. Structures are created as input variables in the PLC, each corresponding to the process image.

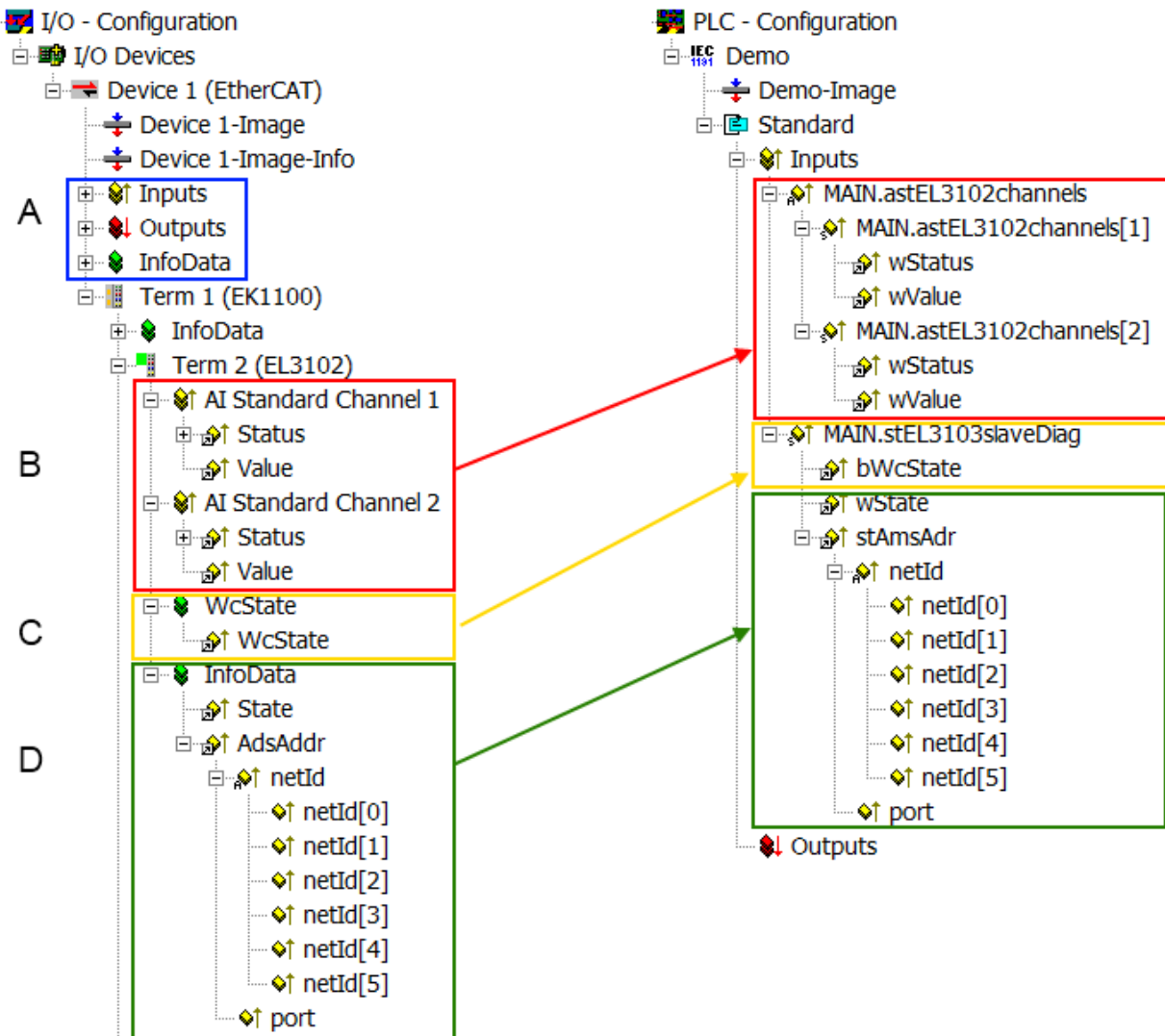



Fig. 88: Basic EtherCAT Slave Diagnosis in the PLC

The following aspects are covered here:

Code	Function	Implementation	Application/evaluation
A	<p>The EtherCAT Master's diagnostic information updated acyclically (yellow) or provided acyclically (green).</p>		<p>At least the DevState is to be evaluated for the most recent cycle in the PLC.</p> <p>The EtherCAT Master's diagnostic information offers many more possibilities than are treated in the EtherCAT System Documentation. A few keywords:</p> <ul style="list-style-type: none"> • CoE in the Master for communication with/through the Slaves • Functions from <i>TcEtherCAT.lib</i> • Perform an OnlineScan
B	<p>In the example chosen (EL3102) the EL3102 comprises two analogue input channels that transmit a single function status for the most recent cycle.</p>	<p>Status</p> <ul style="list-style-type: none"> • the bit significations may be found in the device documentation • other devices may supply more information, or none that is typical of a slave 	<p>In order for the higher-level PLC task (or corresponding control applications) to be able to rely on correct data, the function status must be evaluated there. Such information is therefore provided with the process data for the most recent cycle.</p>
C	<p>For every EtherCAT Slave that has cyclic process data, the Master displays, using what is known as a WorkingCounter, whether the slave is participating successfully and without error in the cyclic exchange of process data. This important, elementary information is therefore provided for the most recent cycle in the System Manager</p> <ol style="list-style-type: none"> 1. at the EtherCAT Slave, and, with identical contents 2. as a collective variable at the EtherCAT Master (see Point A) <p>for linking.</p>	<p>WcState (Working Counter)</p> <p>0: valid real-time communication in the last cycle</p> <p>1: invalid real-time communication</p> <p>This may possibly have effects on the process data of other Slaves that are located in the same SyncUnit</p>	<p>In order for the higher-level PLC task (or corresponding control applications) to be able to rely on correct data, the communication status of the EtherCAT Slave must be evaluated there. Such information is therefore provided with the process data for the most recent cycle.</p>

Code	Function	Implementation	Application/evaluation
D	<p>Diagnostic information of the EtherCAT Master which, while it is represented at the slave for linking, is actually determined by the Master for the Slave concerned and represented there. This information cannot be characterized as real-time, because it</p> <ul style="list-style-type: none"> • is only rarely/never changed, except when the system starts up • is itself determined acyclically (e.g. EtherCAT Status) 	<p>State current Status (INIT..OP) of the Slave. The Slave must be in OP (=8) when operating normally. <i>AdsAddr</i> The ADS address is useful for communicating from the PLC/task via ADS with the EtherCAT Slave, e.g. for reading/writing to the CoE. The AMS-NetID of a slave corresponds to the AMS-NetID of the EtherCAT Master; communication with the individual Slave is possible via the <i>port</i> (= EtherCAT address).</p>	<p>Information variables for the EtherCAT Master that are updated acyclically. This means that it is possible that in any particular cycle they do not represent the latest possible status. It is therefore possible to read such variables through ADS.</p>



Attention

Diagnostic information

It is strongly recommended that the diagnostic information made available is evaluated so that the application can react accordingly.

CoE Parameter Directory

The CoE parameter directory (CanOpen-over-EtherCAT) is used to manage the set values for the slave concerned. Changes may, in some circumstances, have to be made here when commissioning a relatively complex EtherCAT Slave. It can be accessed through the TwinCAT System Manager, see Fig. “EL3102, CoE directory”:

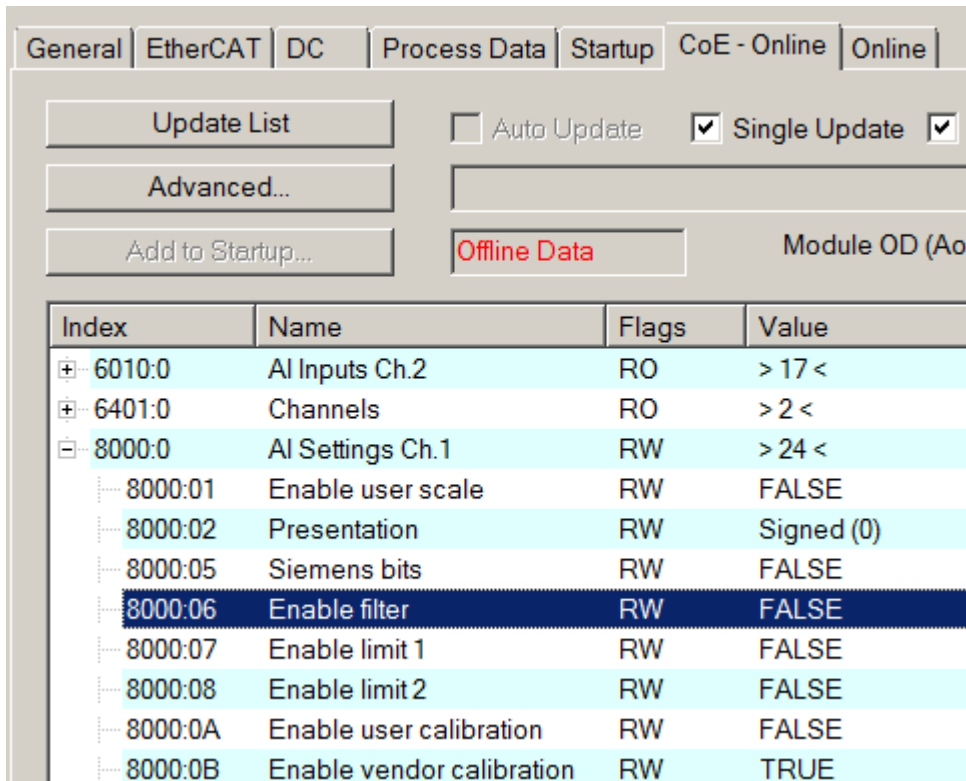

Index	Name	Flags	Value
6010:0	AI Inputs Ch.2	RO	> 17 <
6401:0	Channels	RO	> 2 <
8000:0	AI Settings Ch.1	RW	> 24 <
8000:01	Enable user scale	RW	FALSE
8000:02	Presentation	RW	Signed (0)
8000:05	Siemens bits	RW	FALSE
8000:06	Enable filter	RW	FALSE
8000:07	Enable limit 1	RW	FALSE
8000:08	Enable limit 2	RW	FALSE
8000:0A	Enable user calibration	RW	FALSE
8000:0B	Enable vendor calibration	RW	TRUE

Fig. 89: EL3102, CoE directory



Note

EtherCAT System Documentation

The comprehensive description in the [EtherCAT System Documentation](#) (EtherCAT Basics --> CoE Interface) must be observed!

A few brief extracts:

- Whether changes in the online directory are saved locally in the slave depends on the device. EL terminals (except the EL66xx) are able to save in this way.
- The user must manage the changes to the StartUp list.

Commissioning aid in the TwinCAT System Manager

Commissioning interfaces are being introduced as part of an ongoing process for EL/EP EtherCAT devices. These are available in TwinCAT System Managers from TwinCAT 2.11R2 and above. They are integrated into the System Manager through appropriately extended ESI configuration files.

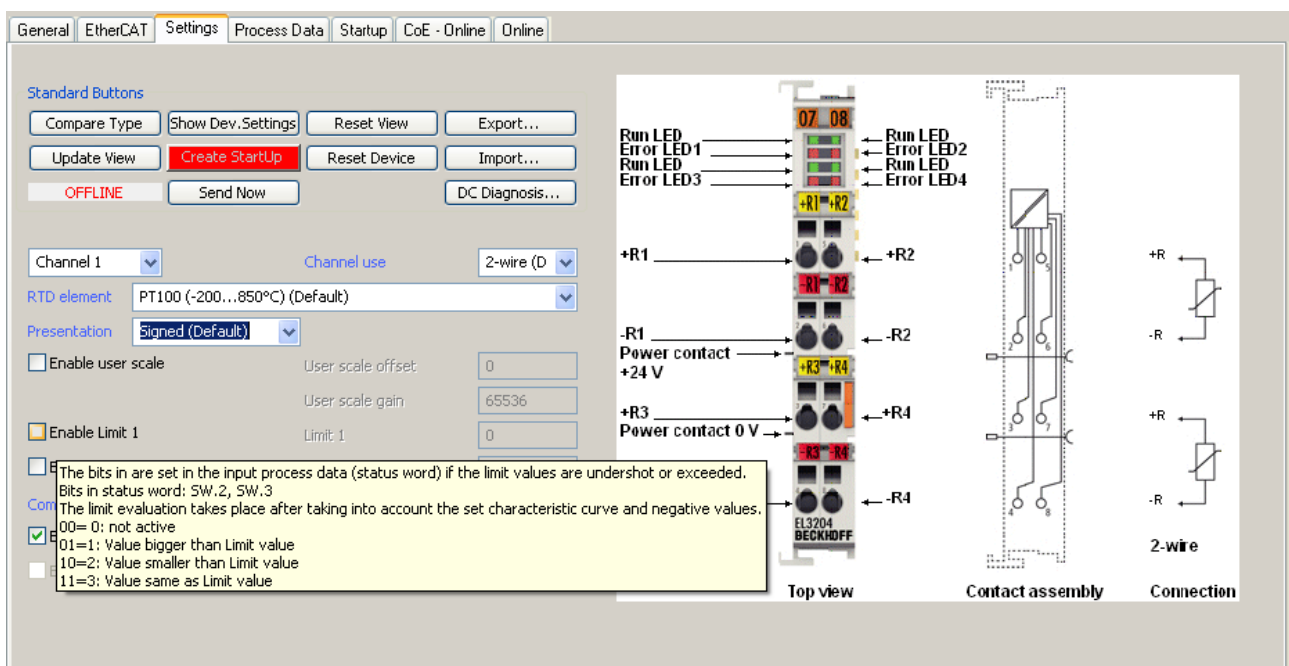

Fig. 90: Example of commissioning aid for a EL3204

This commissioning process simultaneously manages

- CoE Parameter Directory
- DC/FreeRun mode
- the available process data records (PDO)

Although the "Process Data", "DC", "Startup" and "CoE-Online" that used to be necessary for this are still displayed, it is recommended that, if the commissioning aid is used, the automatically generated settings are not changed by it.

The commissioning tool does not cover every possible application of an EL/EP device. If the available setting options are not adequate, the user can make the DC, PDO and CoE settings manually, as in the past.

EtherCAT State: automatic default behaviour of the TwinCAT System Manager and manual operation

After the operating power is switched on, an EtherCAT Slave must go through the following statuses

- INIT
- PREOP

- SAFEOP
- OP

to ensure sound operation. The EtherCAT Master directs these statuses in accordance with the initialization routines that are defined for commissioning the device by the ES/XML and user settings (Distributed Clocks (DC), PDO, CoE). See also the section on "Principles of Communication, EtherCAT State Machine [▶ 37]" in this connection. Depending how much configuration has to be done, and on the overall communication, booting can take up to a few seconds.

The EtherCAT Master itself must go through these routines when starting, until it has reached at least the OP target state.

The target state wanted by the user, and which is brought about automatically at start-up by TwinCAT, can be set in the System Manager. As soon as TwinCAT reaches the status RUN, the TwinCAT EtherCAT Master will approach the target states.

Standard setting

The advanced settings of the EtherCAT Master are set as standard:

- EtherCAT Master: OP
- Slaves: OP
This setting applies equally to all Slaves.

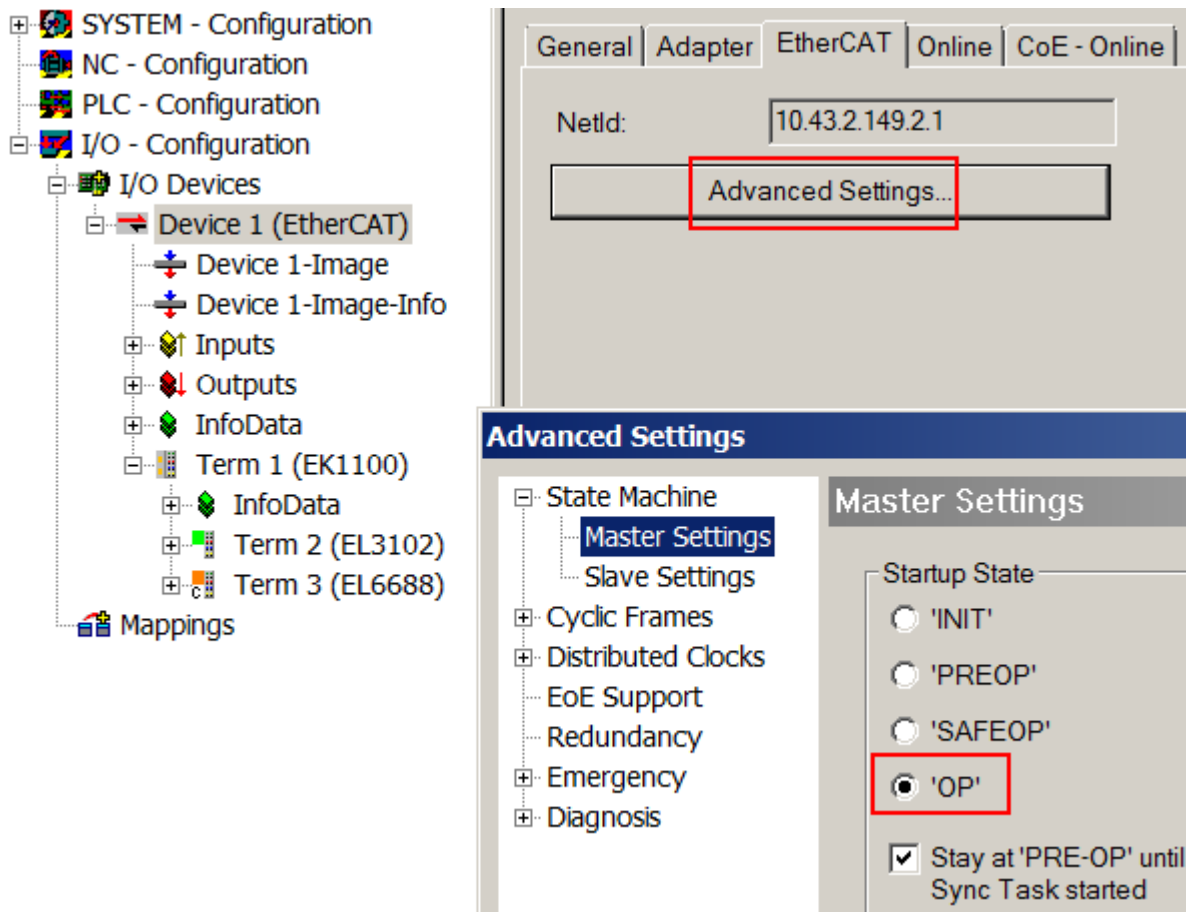

Fig. 91: Default behaviour of the System Manager

In addition, the target state of any particular Slave can be set in the "Advanced Settings" dialogue; the standard setting is again OP.

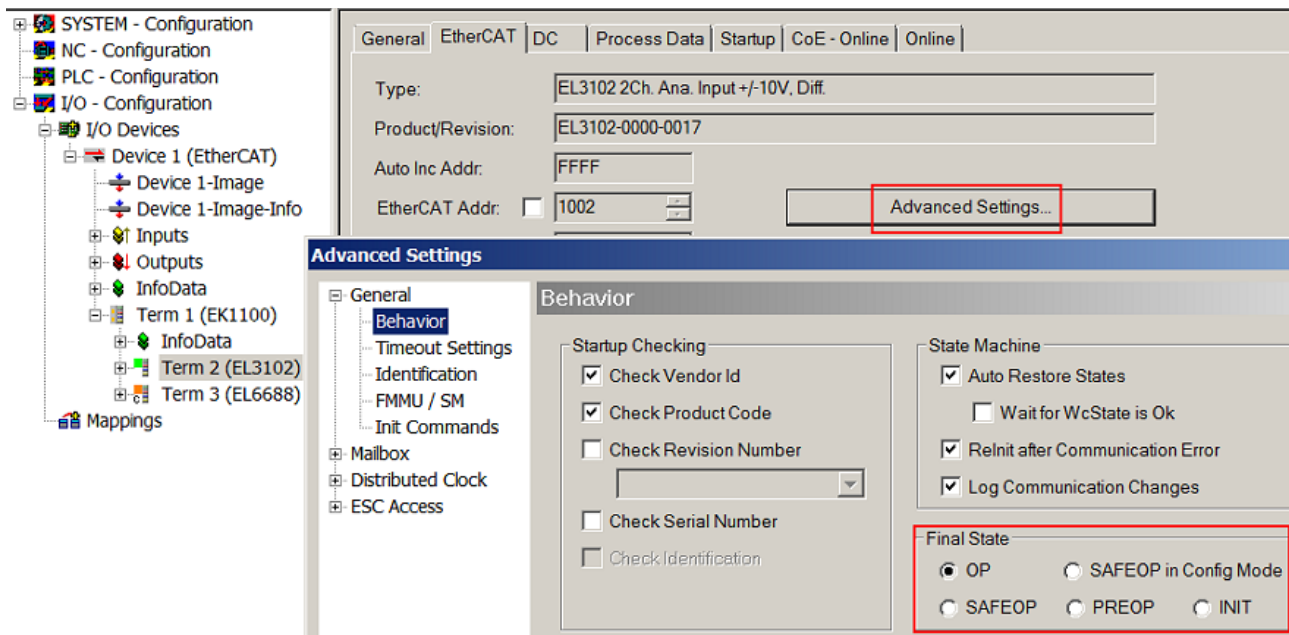

Fig. 92: Default target state in the Slave

Manual Control

There are particular reasons why it may be appropriate to control the states from the application/task/PLC. For instance:

- for diagnostic reasons
- to induce a controlled restart of axes
- because a change in the times involved in starting is desirable

In that case it is appropriate in the PLC application to use the PLC function blocks from the *TcEtherCAT.lib*, which is available as standard, and to work through the states in a controlled manner using, for instance, *FB_EcSetMasterState*.

It is then useful to put the settings in the EtherCAT Master to INIT for master and slave.

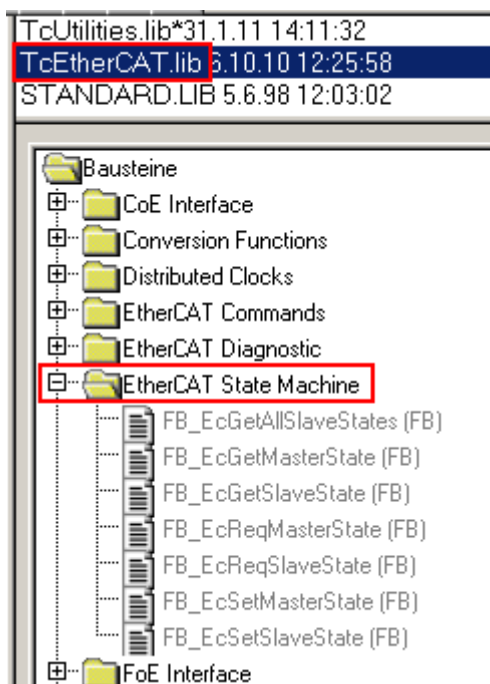

Fig. 93: PLC function blocks

Note regarding E-Bus current

EL/ES terminals are placed on the DIN rail at a coupler on the terminal strand. A Bus Coupler can supply the EL terminals added to it with the E-bus system voltage of 5 V; a coupler is thereby loadable up to 2 A as a rule. Information on how much current each EL terminal requires from the E-bus supply is available online and in the catalogue. If the added terminals require more current than the coupler can supply, then power feed terminals (e.g. EL9410) must be inserted at appropriate places in the terminal strand.

The pre-calculated theoretical maximum E-Bus current is displayed in the TwinCAT System Manager as a column value. A shortfall is marked by a negative total amount and an exclamation mark; a power feed terminal is to be placed before such a position.

General Adapter EtherCAT Online CoE - Online						
NetId:		10.43.2.149.2.1		Advanced Settings...		
Number	Box Name	Address	Type	In Size	Out S...	E-Bus (..
1	Term 1 (EK1100)	1001	EK1100			
2	Term 2 (EL3102)	1002	EL3102	8.0		1830
3	Term 4 (EL2004)	1003	EL2004		0.4	1730
4	Term 5 (EL2004)	1004	EL2004		0.4	1630
5	Term 6 (EL7031)	1005	EL7031	8.0	8.0	1510
6	Term 7 (EL2808)	1006	EL2808		1.0	1400
7	Term 8 (EL3602)	1007	EL3602	12.0		1210
8	Term 9 (EL3602)	1008	EL3602	12.0		1020
9	Term 10 (EL3602)	1009	EL3602	12.0		830
10	Term 11 (EL3602)	1010	EL3602	12.0		640
11	Term 12 (EL3602)	1011	EL3602	12.0		450
12	Term 13 (EL3602)	1012	EL3602	12.0		260
13	Term 14 (EL3602)	1013	EL3602	12.0		70
14	Term 3 (EL6688)	1014	EL6688	22.0		-240 !

Fig. 94: Illegally exceeding the E-Bus current

From TwinCAT 2.11 and above, a warning message "E-Bus Power of Terminal..." is output in the logger window when such a configuration is activated:

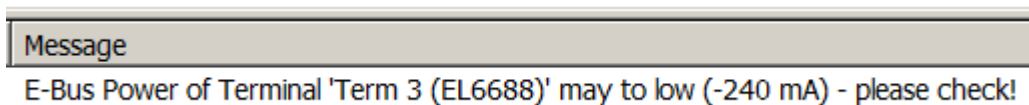



Fig. 95: Warning message for exceeding E-Bus current

 Attention	<p>Caution! Malfunction possible!</p> <p>The same ground potential must be used for the E-Bus supply of all EtherCAT terminals in a terminal block!</p>
---	--

6.3 Control and Status Byte

Control byte

The control byte of the digital input terminals currently has no function.

Status byte

The status byte of the digital input terminals currently has no function.

7 Appendix

7.1 EtherCAT AL Status Codes

For detailed information please refer to the [EtherCAT system description](#).

7.2 UL notice

	<p>Application Beckhoff EtherCAT modules are intended for use with Beckhoff's UL Listed EtherCAT System only.</p>
---	--

	<p>Examination For cULus examination, the Beckhoff I/O System has only been investigated for risk of fire and electrical shock (in accordance with UL508 and CSA C22.2 No. 142).</p>
---	---

	<p>For devices with Ethernet connectors Not for connection to telecommunication circuits.</p>
---	--

Basic principles

Two UL certificates are met in the Beckhoff EtherCAT product range, depending upon the components:

- UL certification according to UL508
Devices with this kind of certification are marked by this sign:



Almost all current EtherCAT products (as at 2010/05) are UL certified without restrictions.

- UL certification according to UL508 with limited power consumption
The current consumed by the device is limited to a max. possible current consumption of 4 A. Devices with this kind of certification are marked by this sign:

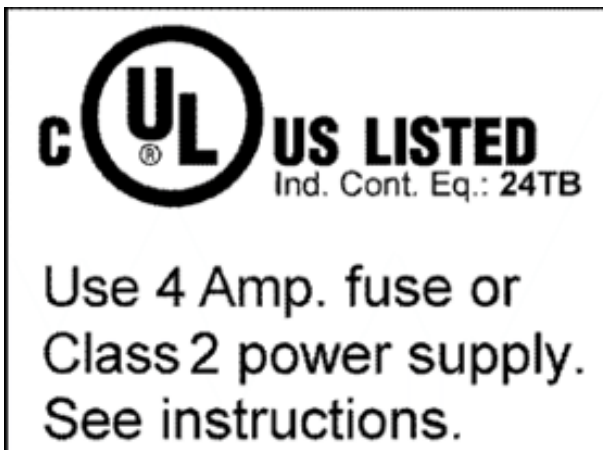

Almost all current EtherCAT products (as at 2010/05) are UL certified without restrictions.

Application

If terminals certified *with restrictions* are used, then the current consumption at 24 V_{DC} must be limited accordingly by means of supply

- from an isolated source protected by a fuse of max. 4A (according to UL248) or
- from a voltage supply complying with *NEC class 2*.
A voltage source complying with *NEC class 2* may not be connected in series or parallel with another *NEC class 2* compliant voltage supply!

These requirements apply to the supply of all EtherCAT bus couplers, power adaptor terminals, Bus Terminals and their power contacts.

7.3 ATEX Documentation

 Note	<p>Notes about operation of the Bus Terminal System in potentially explosive areas (ATEX)</p> <p>Pay also attention to the continuative documentation Notes about operation of the Bus Terminal System in potentially explosive areas (ATEX) that is available in the download area of the Beckhoff homepage http://www.beckhoff.com!</p>
--	--

7.4 Firmware compatibility

The terminals of the EL10xx and EL11xx series have no firmware.

7.5 Firmware Update EL/ES/EM/EPxxxx

This section describes the device update for Beckhoff EtherCAT slaves from the EL/ES, EM, EK and EP series. A firmware update should only be carried out after consultation with Beckhoff support.

Storage locations

An EtherCAT slave stores operating data in up to 3 locations:

- Depending on functionality and performance EtherCAT slaves have one or several local controllers for processing I/O data. The corresponding program is the so-called **firmware** in *.efw format.
- In some EtherCAT slaves the EtherCAT communication may also be integrated in these controllers. In this case the controller is usually a so-called **FPGA** chip with *.rbf firmware.
- In addition each EtherCAT slave has a memory chip for storing its own device description, a so-called **EEPROM**. On power-up this description is loaded and the EtherCAT communication is set up accordingly. The device description is available from the download area of the Beckhoff website at <http://www.beckhoff.com>. All ESI files (**E**therCAT **S**lave **I**nformation) are available in ZIP format.

Customers can access the data via the EtherCAT fieldbus and its communication mechanisms. Acyclic mailbox communication or register access to the ESC is used for updating or reading of these data.

The TwinCAT System Manager offers mechanisms for programming all 3 parts with new data, if the slave is set up for this purpose. Generally the slave does not check whether the new data are suitable, i.e. it may no longer be able to operate if the data are unsuitable.

 Attention	<p>Risk of damage to the device!</p> <p>Note the following when downloading new device files</p> <ul style="list-style-type: none"> • Firmware downloads to an EtherCAT device must not be interrupted • Flawless EtherCAT communication must be ensured. CRC errors or Lost Frames must be avoided. • The power supply must adequately dimensioned. The signal level must meet the specification. <p>In the event of malfunctions during the update process the EtherCAT device may become unusable and require re-commissioning by the manufacturer.</p>
---	--

Device description ESI file/XML

 Attention	<p>Notice regarding update of the ESI description/EEPROM</p> <p>Some slaves have stored calibration and configuration data from the production in the EEPROM. These are irretrievably overwritten during an update.</p>
---	--

The ESI device description is stored locally on the slave and loaded on start-up. Each device description has a unique identifier consisting of slave name (9 characters/digits) and a revision number (4 digits). Each slave configured in the System Manager shows its identifier in the EtherCAT tab:

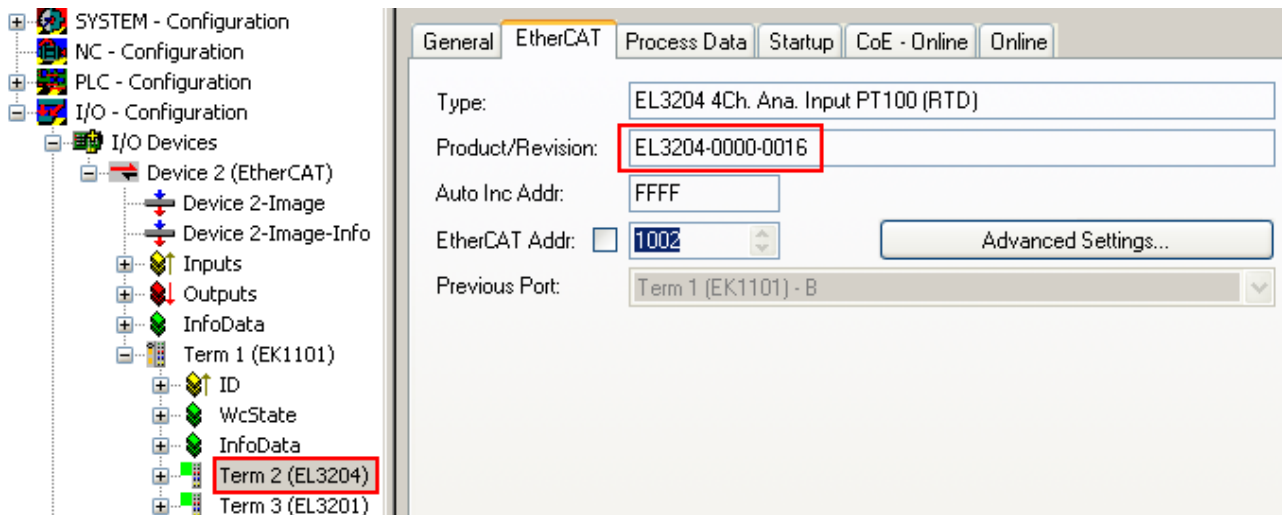

Fig. 96: Device identifier consisting of name EL3204-0000 and revision -0016

The configured identifier must be compatible with the actual device description used as hardware, i.e. the description which the slave has loaded on start-up (in this case EL3204). Generally the configured revision must be equal or lower than the version used in the terminal network.

For further information please refer to the [EtherCAT System Documentation](#).

i

Note

Update of XML/ESI description

The device revision is closely linked to the firmware and hardware used. Incompatible combinations lead to malfunctions or even final shutdown of the device. Corresponding updates should only be carried out in consultation with Beckhoff support.

Display of ESI slave identifier

The simplest way to ascertain compliance of configured and actual device description is to scan the EtherCAT boxes in TwinCAT mode Config/FreeRun:

No	Addr
1	1001
2	1002

Fig. 97: Scan the subordinate field by right-clicking on the EtherCAT device in Config/FreeRun mode

If the found field matches the configured field, the display shows

EL10xx, EL11xx

Version: 4.1

93



Fig. 98: Configuration is identical

otherwise a change dialog for entering the actual data in the configuration.

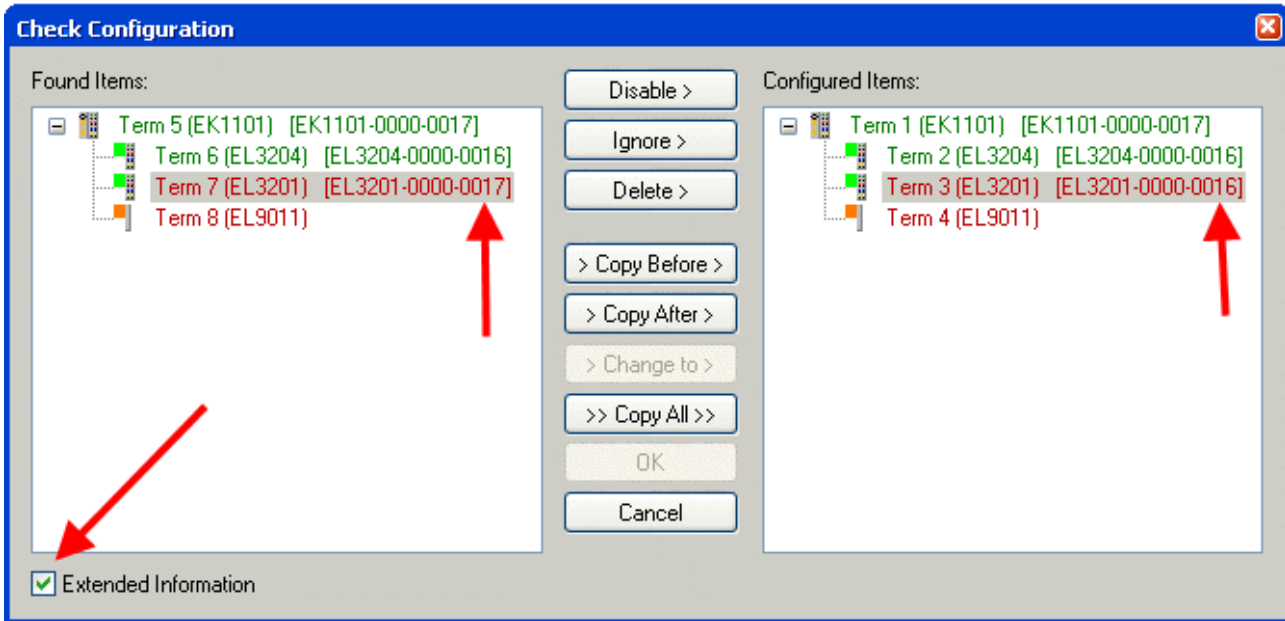

Fig. 99: Change dialog

In the example shown in Fig. “Change dialog”, an EL3201-0000-0017 was found, while an EL3201-0000-0016 had been configured. In this case it makes sense to adapt the configuration with the *Copy Before* button. The *Extended Information* checkbox must be set in order to have the revision displayed.

Changing the ESI slave identifier

The ESI/EEPROM identifier can be updated as follows under TwinCAT:

- The EtherCAT communication with the slave must be flawless.
- The state of the slave is irrelevant.
- Right-click on the slave in the online display to bring up the *EEPROM Update* dialog, Fig. “EEPROM Update”.

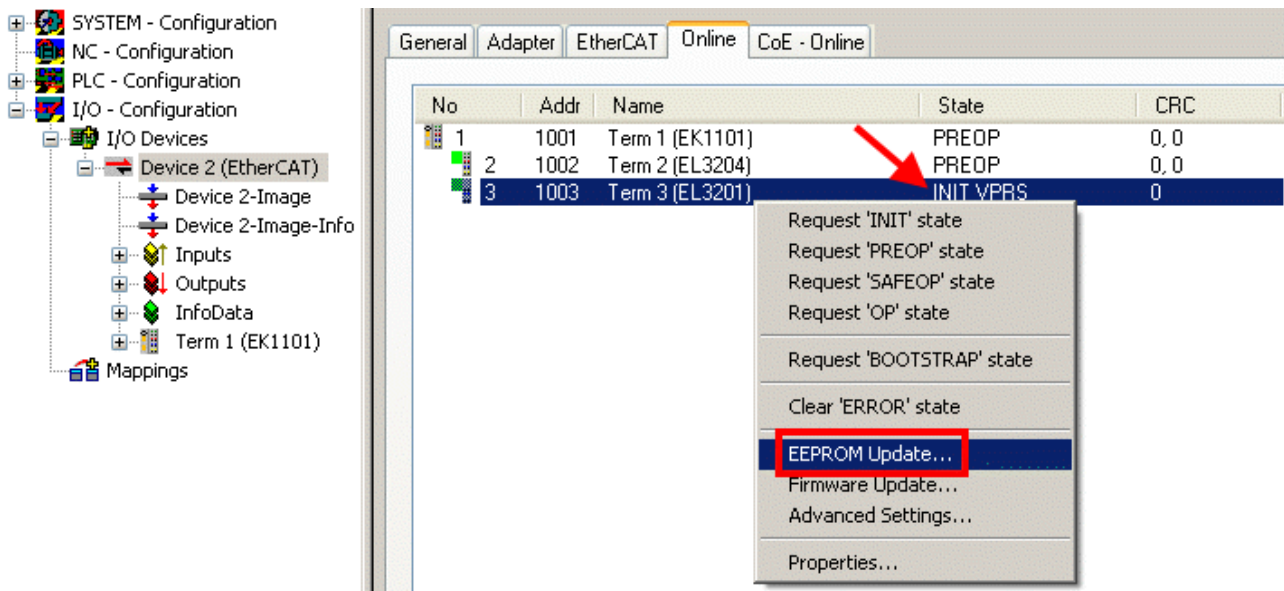

Fig. 100: EEPROM Update

Select the new ESI description in the following dialog, see Fig. “Selecting the new ESI”. The ShowHiddenDevices checkbox also shows older, usually hidden slave versions.

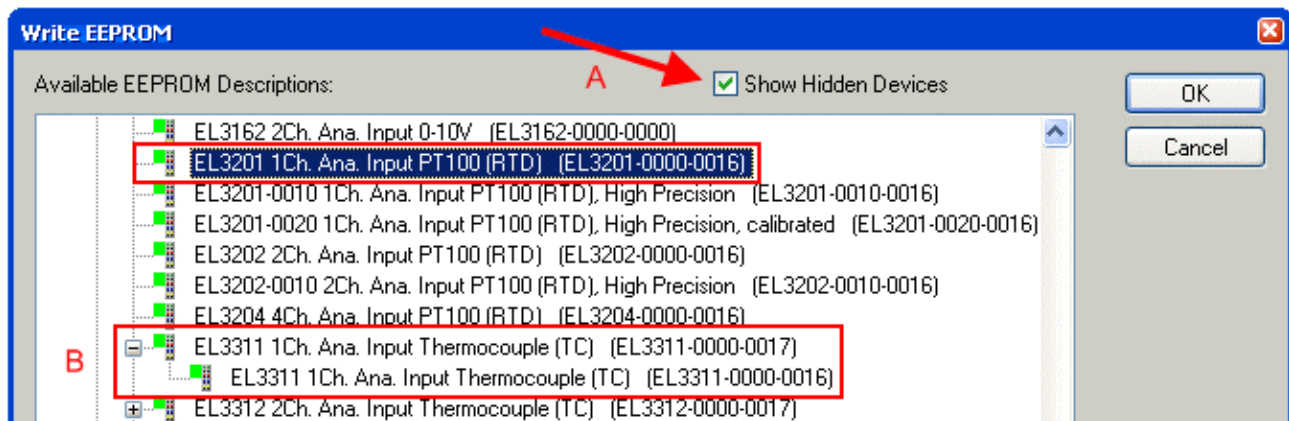



Fig. 101: Selecting the new ESI

A progress bar in the System Manager shows the progress. Data are first written, then verified.

 Note	<p>The change only takes effect after a restart.</p> <p>Most EtherCAT devices read a modified ESI description immediately or after startup from the INIT. Some communication settings such as distributed clocks are only read during power-on. The EtherCAT slave therefore has to be switched off briefly in order for the change to take effect.</p>
--	--

Determining the firmware version

Determining the version on laser inscription

Beckhoff EtherCAT slaves feature serial numbers applied by laser. The serial number has the following structure: **KK YY FF HH**

- KK - week of production (CW, calendar week)
- YY - year of production
- FF - firmware version
- HH - hardware version

Example with ser. no.: 12 10 03 02:

12 - week of production 12
 10 - year of production 2010
 03 - firmware version 03
 02 - hardware version 02

Determining the version via the System Manager

The TwinCAT System Manager shows the version of the controller firmware if the master can access the slave online. Click on the E-Bus Terminal whose controller firmware you want to check (in the example terminal 2 (EL3204)) and select the tab *CoE Online* (CAN over EtherCAT).

Note

CoE Online and Offline CoE

Two CoE directories are available:

- **online**: This is offered in the EtherCAT slave by the controller, if the EtherCAT slave does supported it. This CoE directory can only be displayed if a slave is connected and operational.
- **offline**: The EtherCAT Slave Information ESI/XML may contain the default content of the CoE. This CoE directory can only be displayed if it is included in the ESI (e.g. "Beckhoff EL5xxx.xml").

The Advanced button must be used for switching between the two views.

In Fig. "Display of EL3204 firmware version" the firmware version of the selected EL3204 is shown as 03 in CoE entry 0x100A.

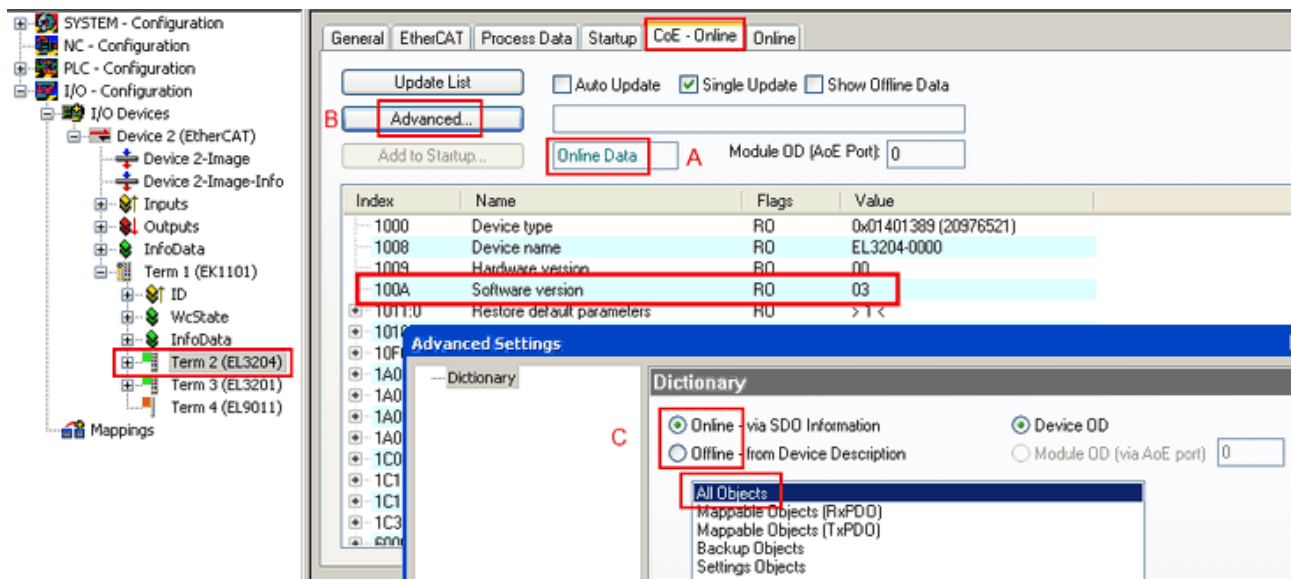

Index	Name	Flags	Value
1000	Device type	RO	0x01401389 (20976521)
1008	Device name	RO	EL3204-0000
1009	Hardware version	RO	00
100A	Software version	RO	03
1011:0	Restore default parameters	HU	> 1 <

Fig. 102: Display of EL3204 firmware version

In (A) TwinCAT 2.11 shows that the Online CoE directory is currently displayed. If this is not the case, the Online directory can be loaded via the *Online* option in Advanced Settings (B) and double-clicking on *AllObjects*.

Updating controller firmware *.efw

Note

CoE directory

The Online CoE directory is managed by the controller and stored in a dedicated EEPROM, which is generally not changed during a firmware update.

To update the controller firmware of a slave switch to tab *Online*, see Fig. "Firmware Update".

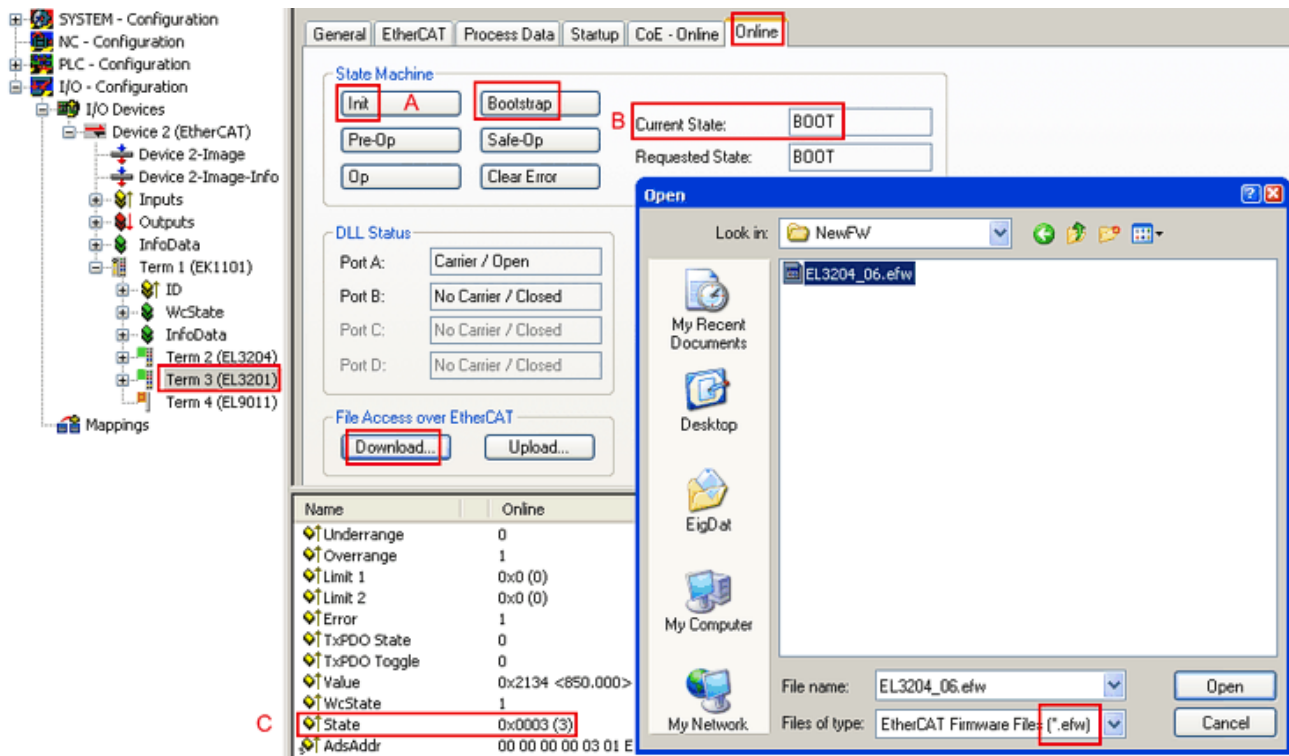

Fig. 103: Firmware Update

Proceed as follows, unless instructed otherwise by Beckhoff support.

- Switch slave to INIT (A)
- Switch slave to BOOTSTRAP
- Check the current status (B, C)
- Download the new *.efw file
- After the download switch to INIT, then OP
- Switch off the slave briefly

FPGA firmware *.rbf

If an FPGA chip deals with the EtherCAT communication an update may be accomplished via an *.rbf file.

- Controller firmware for processing I/O signals
- FPGA firmware for EtherCAT communication (only for terminals with FPGA)

The firmware version number included in the terminal serial number contains both firmware components. If one of these firmware components is modified this version number is updated.

Determining the version via the System Manager

The TwinCAT System Manager indicates the FPGA firmware version. Click on the Ethernet card of your EtherCAT strand (Device 2 in the example) and select the *Online* tab.

The *Reg:0002* column indicates the firmware version of the individual EtherCAT devices in hexadecimal and decimal representation.

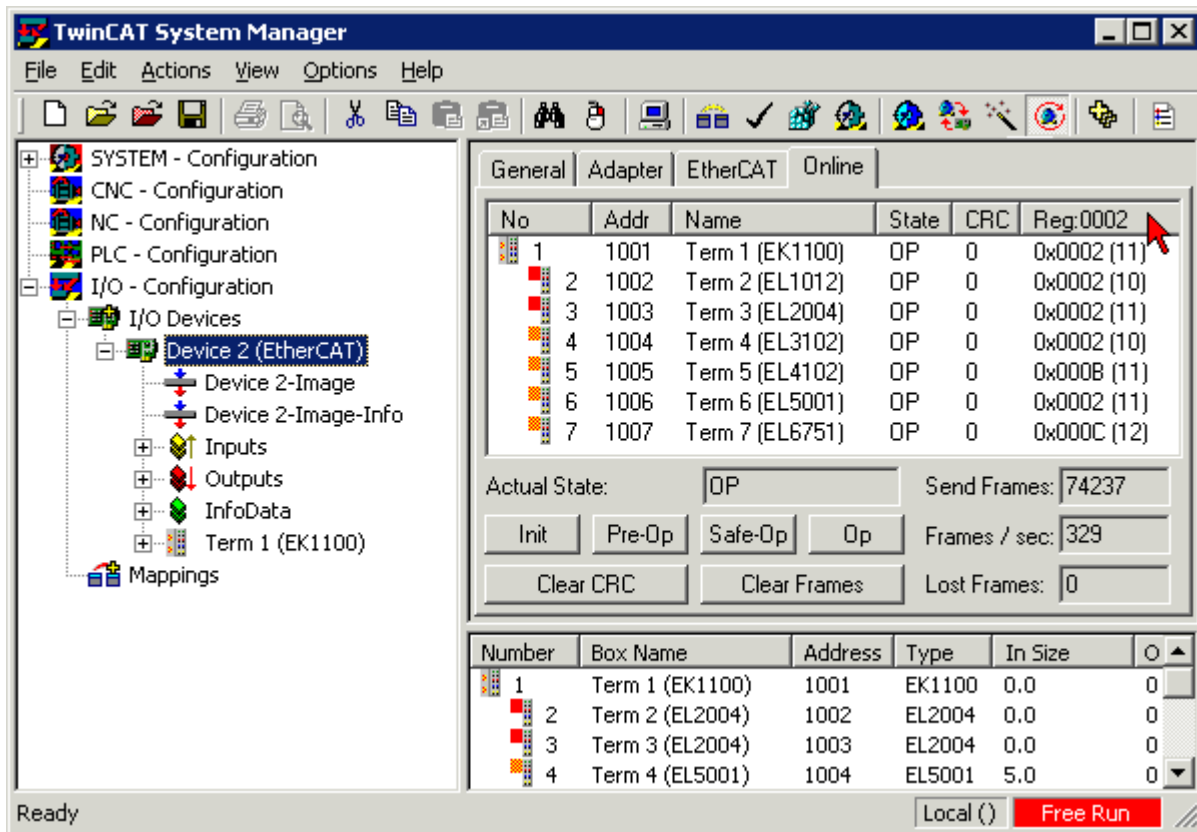

Fig. 104: FPGA firmware version definition

If the column Reg:0002 is not displayed, right-click the table header and select *Properties...* in the context menu.

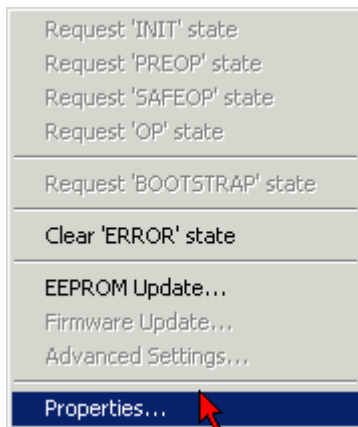

Fig. 105: Context menu Properties

The *Advanced Settings* dialog appears where the columns to be displayed can be selected. Under *Diagnosis/Online View* select the *'0002 ETxxx Build'* check box in order to activate the FPGA firmware version display.

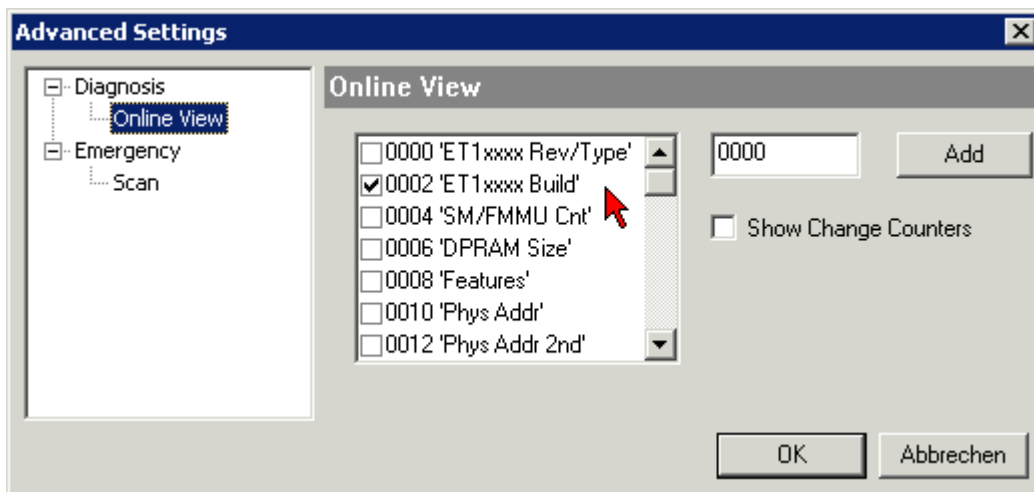

Fig. 106: Dialog Advanced Settings

Update

For updating the FPGA firmware

- of an EtherCAT coupler the coupler must have FPGA firmware version 11 or higher;
- of an E-Bus Terminal the terminal must have FPGA firmware version 10 or higher.

Older firmware versions can only be updated by the manufacturer!

Updating an EtherCAT device

In the TwinCAT System Manager select the terminal whose FPGA firmware you want to update (in this example terminal 5: EL5001) and click on *Advanced Settings* in the *EtherCAT* tab.

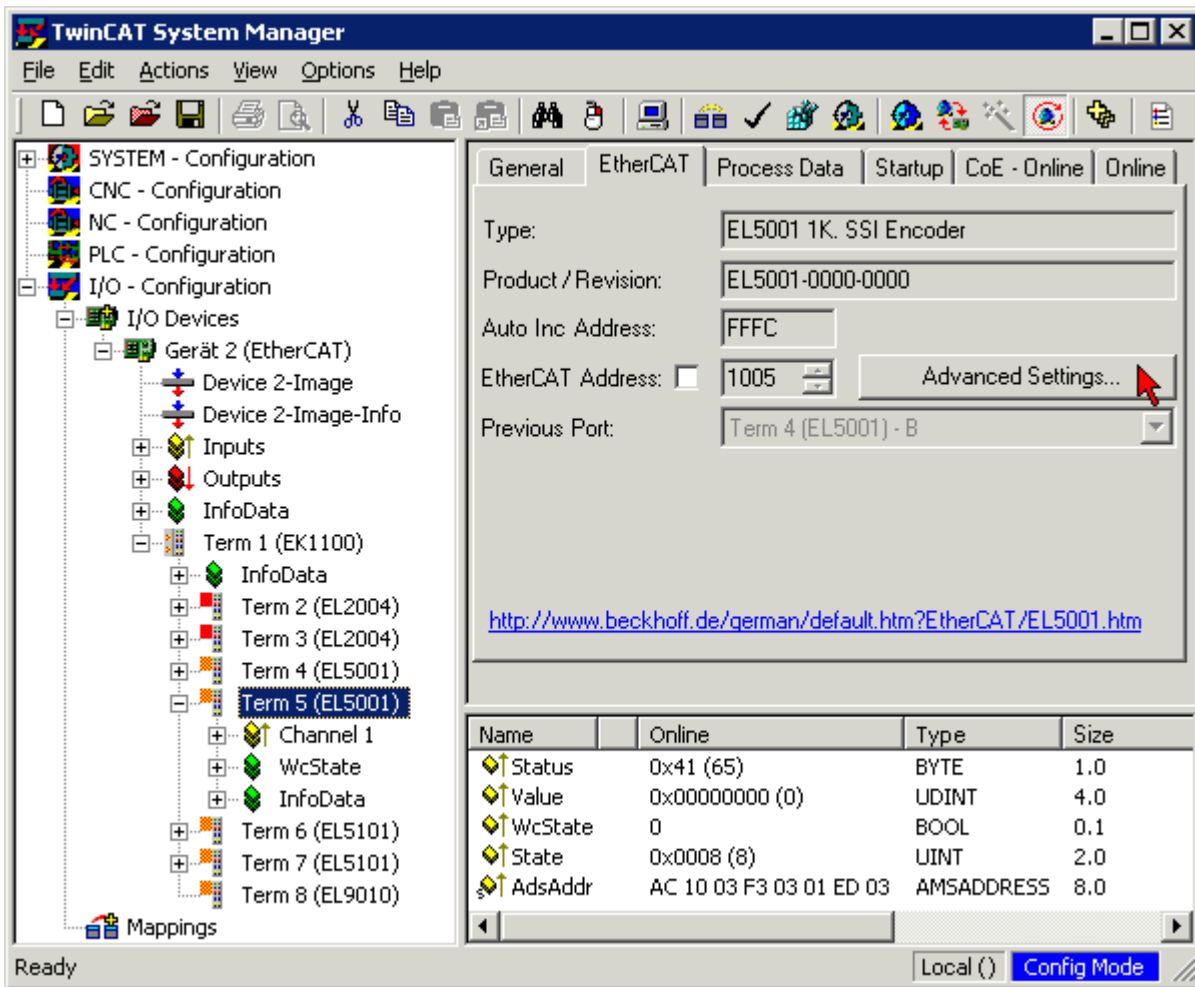

Fig. 107: Select dialog Advanced Settings

The Advanced Settings dialog appears. Under ESC Access/E²PROM/FPGA click on Write FPGA button,

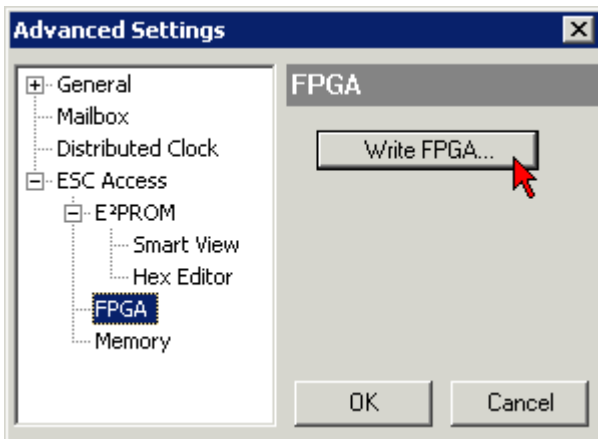

Fig. 108: Select dialog FPGA

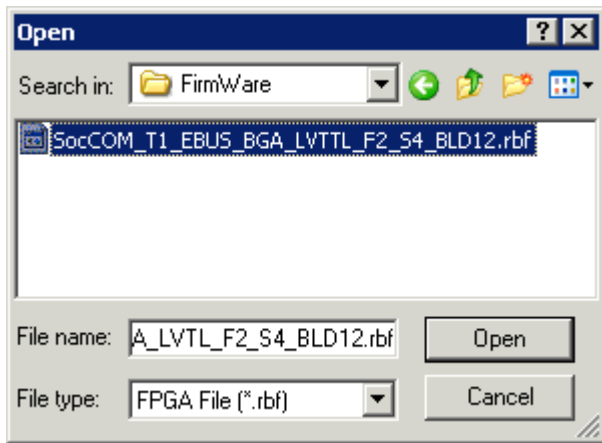



Fig. 109: Write FPGA

select the file (*.rbf) with the new FPGA firmware, and transfer it to the EtherCAT device.

 Attention	<p>Risk of damage to the device!</p> <p>A firmware download to an EtherCAT device must never be interrupted! If this process is cancelled, the supply voltage switched off or the Ethernet connection interrupted, the EtherCAT device can only be recommissioned by the manufacturer!</p>
---	---

In order to activate the new FPGA firmware a restart (switching the power supply off and on again) of the EtherCAT device is required.

Simultaneous updating of several EtherCAT devices

The firmware and ESI descriptions of several devices can be updated simultaneously, provided the devices have the same firmware file/ESI.

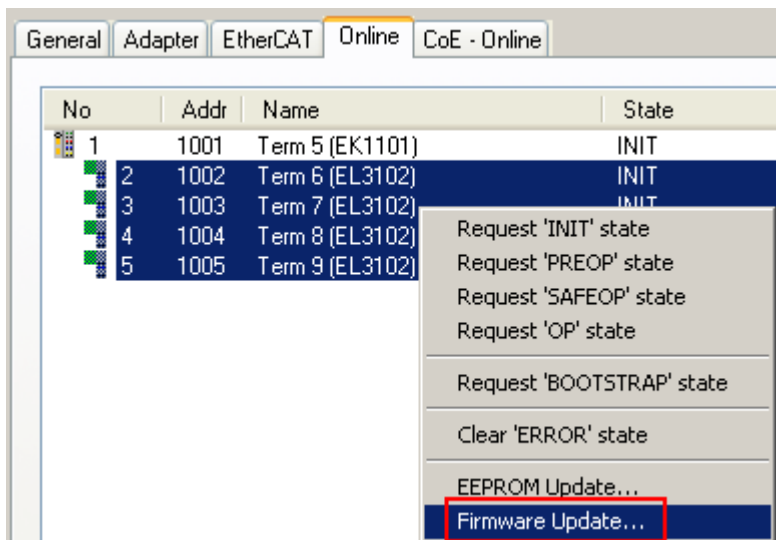

Fig. 110: Multiple selection and firmware update

Select the required slaves and carry out the firmware update in BOOTSTRAP mode as described above.