

Contents		Page
General		Informations 2
		Technical data 3
		Basic designs 4 - 8
Cam Switches		On-Off switches, Changeover switches 9 -12
		Star-Delta switches 13 - 15
		Multi speed switches 16 - 20
		Control switches 21 - 23
		Voltmeter selector switches, Ammeter switches 24 - 26
		Gang switches 27 - 29
		Multi step switches 30 - 41
Mini-Cam Switches		Technical data 42
		On-Off switches, Changeover switches 43
		Star-Delta switches 43
		Control switches 43, 44
		Voltmeter selector switches, Ammeter switches 44
		Gang switches, Multi step switches 44, 45
Main switches		Switch disconnectors with padlock device 46 - 48
		Accessories 51
		Cam switches with padlock device 52
Switch disconnectors		On-Off switches 53
Load switches		On-Off switches 54
		Changeover switches 55
Handles and plates		Operating knobs and handles 56, 57
		Escutcheon plates 58 - 61
		Angles of rotation 61, 62
Optional Extras		Drive units 63
		Door couplings 64
		Key operated switches 65
		Padlock devices 66
		Switch interlocks, Couplings 67, 68
		Accessories 69, 70
Special switches		71, 96
Technical data		Cam switches 73, 74
		Switch disconnectors 75
		Load switches 76
Dimensions		Cam switches 77 - 80
		Main and Emergency-Off switches 81 - 84
		Switch disconnectors, Load switches 85
		Accessories 86 - 93
Representations and Suppliers		94, 95

Telux - - Cam Switches

Ratings								Designs			
Typ	Rated current Therm.			Motor			Plate mm	Panel mount.	Single hole mount. Ø22,5mm	Flush mount.	
	I_{in} open A	AC21 A	atU _e V	AC3 3~400V kW	AC23 3~400V A	AC23 3~400V kW		M10H, M20 IP65 IP40	with Plate IP65	without Plate IP65	IP40
M4H	10	10	440	2,2	6	3	30□	M4H E	M4H Z	M4H ZO	-
M10H	20	20	690	5,5	16	7,5	48□	M10H E	M10H Z	M10H ZO	-
M10	20	20	440	5,5	16	7,5	48□	-	-	-	M10 UP
M20	32	32	690	11	30	15	48□	M20 E	M20 Z	M20 ZO	-
N20	32	32	690	11	30	15	64□	N20 E	-	-	N20 UP
N33F	50	50	690	15	45	22	64□	N33F E	N33F Z	-	-
N32	40	40	690	11	30	15	64□	-	-	-	-
N40	63	63	690	15	45	22	88□	N40 E	-	-	-
N60	85	85	690	25	60	30	88□	N60 E	-	-	-
N80	115	115	690	30	85	45	88□	N80 E	-	-	-
L100	125	125	690	15	45	22	88□	L100 E	-	-	-
L160	180	180	690	25	60	30	88□	L160 E	-	-	-
N100	150	150	690	40	110	55	132□	N100 E	-	-	-
N200	250	250	690	70	140	70	132□	N200 E	-	-	-
L400	400	400	690	70	140	70	132□	L400 E	-	-	-
L600	600	400	690	70	140	70	132□	L600 E	-	-	-
L800	800	400	690	70	140	70	132□	L800 E	-	-	-
L1200	1200	400	690	70	140	70	132□	L1200 E	-	-	-







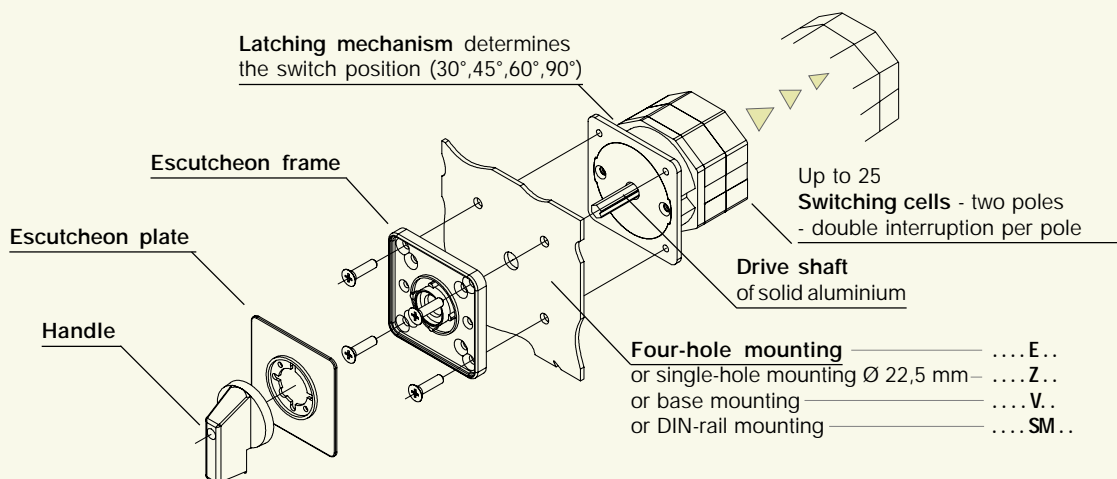

Cam Switches 10 - 250A

Cam switches can be used for virtually all purposes, e.g. as motor, main, control or instrument switches. Over and above the switching programs mentioned in the list, an effectively limitless number of special programs can be implemented.

Load switch L.. 125 - 1200A



Load switches are primarily employed where resistive or slightly inductive current loads are to be switched on and off, or switching takes place without loading. Load switches are assembled by parallel switching of two or more of cam switch contacts. With customer built main terminal protection, load switch L... can also be used as main switch.

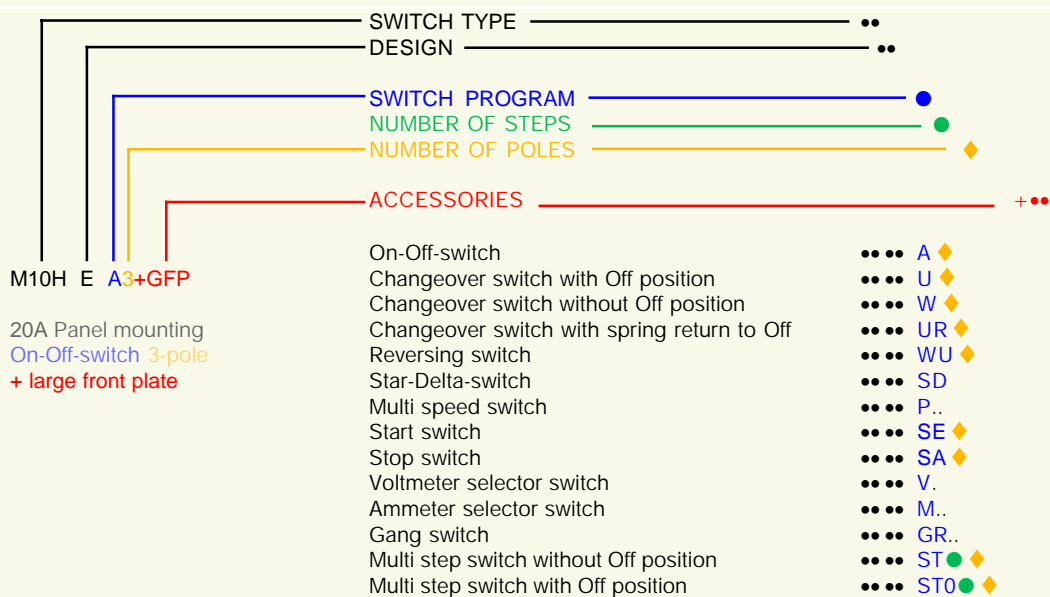

Designs Base mounting IP40	DIN-rail mounting IP40	Modular IP40	Plastic enclosed ..P.. IP40 ..PF.. IP65	horizontal, IP65	Motor switch enclosed IP65	Terminal box mounting IP65	Cast enclosed ..G.. IP40 ..GF.. IP65
							
-	-	-	-	-	-	-	-
M10H V ♦	M10H SM ♦	M10H SMA ♦	-	-	M10H PM ♦	-	-
-	-	-	M10 P(F) ♦	-	-	M10 KE ♦	-
M20 V ♦	M20 SM ♦	M20 SMA ♦	-	-	-	-	-
N20 V ♦	N20 SM ♦	-	N20 P(F) ♦	-	N20 PM ♦	N20 KE ♦	N20 G(F) ♦
N33F V ♦	N33F SM ♦	-	N33F P(F) ♦	-	N33F PM ♦	N33F KE ♦	-
-	-	-	-	-	-	-	N32 G(F) ♦
N40 V ♦	-	-	N40 P(F) ♦	N40 PLF ♦	-	-	-
N60 V ♦	-	-	N60 P(F) ♦	N60 PLF ♦	-	-	-
N80 V ♦	-	-	N80 P(F) ♦	N80 PLF ♦	-	-	-
L100 V ♦	-	-	-	-	-	-	-
L160 V ♦	-	-	-	-	-	-	-
N100 V ♦	-	-	N100 P(F) ♦	-	-	-	-
N200 V ♦	-	-	N200 P(F) ♦	-	-	-	-
L400 V ♦	-	-	-	-	-	-	-
L600 V ♦	-	-	-	-	-	-	-
L800 V ♦	-	-	-	-	-	-	-
L1200 V ♦	-	-	-	-	-	-	-

Ordering



Type	Ratings			Protection degree from front in mounted position				Main Switch Emergency Stop		
	Rated current Therm. I _{th open} A	AC21 A	bei U _e V	Motor AC3 3~400V kW	AC23 3~400V A		Plate Switch disconnector mm	Panel mounting IP65	Single hole mount. Ø22,5mm IP65	Base mounting with door coupling adjust. installation depth LTS.. IP65 LT.. IP40
LTS20	20	20	690	4	12	5,5	48□			
LTS25	25	25	690	5,5	16	7,5	48□	LTS25 EHN1 .. LTS25 EHN4 ..	LTS25 ZHN1 ..	LTS25 VZVHN4 .. LTS25 VHN4 ..
LTS32	32	32	690	7,5	23	11	48□	LTS32 EHN1 .. LTS32 EHN4 ..	LTS32 ZHN1 ..	LTS32 VZVHN4 .. LTS32 VHN4 ..
LTS40	40	40	690	11	30	15	48□	LTS40 EHN1 .. LTS40 EHN4 ..	LTS40 ZHN1 ..	LTS40 VZVHN4 .. LTS40 VHN4 ..
LTS63	63	63	690	15	45	22	48□	LTS63 EHN1 .. LTS63 EHN4 ..	-	LTS63 VZVHN4 .. LTS63 VHN4 ..
LTS80	80	80	690	18,5	45	22	48□	LTS80 EHN1 .. LTS80 EHN4 ..	-	LTS80 VZVHN4 .. LTS80 VHN4 ..
LT80	80	80	690	22	60	30	64□	LT80 EHN34 ..	-	LT80 VHN34 ..
LT100	100	100	690	30	72	37	64□	LT100 EHN34 ..	-	LT100 VHN34 ..
LT125	125	125	690	37	85	45	88□	LT125 EHN34 ..	-	LT125 VHN34 ..
LT160	160	160	690	45	110	55	88□	LT160 EHN34 ..	-	LT160 VHN34 ..

Switch disconnecter LT.. 20 - 160A

Switch disconnectors are to be used as an ON-OFF-switch where a high breaking capacity with high contact pressure and in fact better short circuit behavior is necessary. These applications are:

Main switches according to IEC/EN 60204 respectively VDE0113 with interlocking device, terminal protection and restreictive contacts.

Switch disconnectors according to IEC/EN 60947-3 and VDE 0660 part 107 with break distance for 690V.

Motor switches 3-pole or 4-pole; according to IEC/EN 60947-3 respectively VDE 0660 part 107, motor switches series LT are dimensioned for switching high rated current AC3 and AC23A.



Main switches and Main switches with Emergency-Stop function

According to standards IEC/EN60204 or VDE0113, all electrical equipment of industrial machines must be equipped with a main switch. This must permit disconnection of all the electrical equipment during cleaning, maintenance and repair work, and other extended periods when it is stationary.

In case of two or more main switches, an interlock system must be used. It is recommended to use a multiple-pole main switch (cam switch).

Main switches have to correspond to:

- Switch disconnecter according to IEC/EN 60947-3 and VDE 0660 part 107 for utilization category AC23-B or DC-23B.
- Disconnectors are selected according to thermal rated current. They must possess a contact that ensures load switching via the contactors (see switching program A3-10). This contact must have a sufficient AC15 switching capacity.
- The interruption capacity of the switch must equal or exceed the locked rotor current of the largest motor plus the total current of all other electrical equipment in the circuit.

Requirements:

Interruption of the electrical equipment, with only on and off positions clearly marked with O and I.

It must be lockable in the off setting.

The line terminals of the main switch must be protected according to utilization category IP2X.

Colour of handle black or grey.

Main switches with Emergency-Off function are additional supplied with red handles and contrasting yellow escutcheon plates.

Main Switch Emergency Stop Base mounting w. door coupling depth not adjustable IP65			Main Switch Panel mounting IP65			Switch Disconnectors Panel mounting IP65	
for Distribution Boards IP40		Plastic enclosed IP65	Base mounting with door coupling LTS.. IP65 LT.. IP40		for Distribution Boards IP40		
LTS20 VZHN1 .. LTS20 VZHN4 ..	LTS20 SMAHN1 ..	LTS20 PFHN4 ..	LTS20 EH1 .. LTS20 EH4 ..	LTS20 VZVH4 .. LTS20 VH4 ..	LTS20 E ..	LTS20 SMA ..	
LTS25 VZHN1 .. LTS25 VZHN4 ..	LTS25 SMAHN1 ..	LTS25 PFHN4 ..	LTS25 EH1 .. LTS25 EH4 ..	LTS25 VZVH4 .. LTS25 VH4 ..	LTS25 E ..	LTS25 SMA ..	
LTS32 VZHN1 .. LTS32 VZHN4 ..	LTS32 SMAHN1 ..	LTS32 PFHN4 ..	LTS32 EH1 .. LTS32 EH4 ..	LTS32 VZVH4 .. LTS32 VH4 ..	LTS32 E ..	LTS32 SMA ..	
LTS40 VZHN1 .. LTS40 VZHN4 ..	LTS40 SMAHN1 ..	LTS40 PFHN4 ..	LTS40 EH1 .. LTS40 EH4 ..	LTS40 VZVH4 .. LTS40 VH4 ..	LTS40 E ..	LTS40 SMA ..	
LTS63 VZHN1 .. LTS63 VZHN4 ..	LTS63 SMAHN1 ..	LTS63 PFHN4 ..	LTS63 EH1 .. LTS63 EH4 ..	LTS63 VZVH4 .. LTS63 VH4 ..	LTS63 E ..	LTS63 SMA ..	
LTS80 VZHN1 .. LTS80 VZHN4 ..	LTS80 SMAHN1 ..	LTS80 PFHN4 ..	LTS80 EH1 .. LTS80 EH4 ..	LTS80 VZVH4 .. LTS80 VH4 ..	LTS80 E ..	LTS80 SMA ..	
-	LT80 SMAHN1 ..	LT80 PFHN34 ..	LT80 EH34 ..	LT80 VH34 ..	LT80 E ..	LT80 SMA ..	
-	LT100 SMAHN1 ..	LT100 PFHN34 ..	LT100 EH34 ..	LT100 VH34 ..	LT100 E ..	LT100 SMA ..	
-	-	LT125 PFHN34 ..	LT125 EH34 ..	LT125 VH34 ..	LT125 E ..	-	
-	-	LT160 PFHN34 ..	LT160 EH34 ..	LT160 VH34 ..	LT160 E ..	-	

Switch program

On-Off Switch 3-pole	●●●●● A3	
On-Off Switch 4-pole	●●●●● A4	
On-Off Switch 6-pole	●●●●● A6	
On-Off Switch 8-pole	●●●●● A8	
Changeover Switches 3-pole	●●●●● U3	
Changeover Switches 4-pole	●●●●● U4	
On-Off Switch 3-pole	●●●●● T300	(for LT80 - LT160)
On-Off Switch 4-pole	●●●●● T400	(for LT80 - LT160)

Panel mounting designs

Switches of the panel mounting designs listed below have protection from front IP40. Where a shaft seal (appendix +WD) is used, the protection is increased to IP54. Use of a moisture proofing cap (appendix +FR) results in an increase in rear protection to IP54. In the standard version, the switches are delivered with a square escutcheon plate and black twist knob. Forward mounting is possible for some of

the design E switches. The position of the terminals of the standard switches is left and right, at switch M10H the terminals are above and below. Where a knob insert is turned by 90° (can easily be performed after delivery), the position of the terminals can be changed.

Dimensions see page 75.



Design	Type appendix	Possible switch sizes					
		M10H	M20	N20 N33F	N40 N60 N80	N100 N200	L...
Panel mounting For installation in control panels, machines and equipment. For panel thickness of over 5mm, an extended switch shaft is required (appendix +VW). Protection from front: M10H, M20 IP65 all others IP40	E	X	X	X	X	X	X
Central fixing 22,5mm Switch for mounting with standard 22,5mm mounting holes and 1-4mm panel thickness. Protection from front: IP65 Wrench J7049 necessary	Z	X	X	X ³⁾	-	-	-
Central fixing 22,5mm Switch without escutcheon plate , for installation with standard 22,5mm mounting holes and 1-4mm panel thickness. Protection from front: IP65 Wrench J7049 necessary	ZO	X	X	-	-	-	-
Flush mounting version Switch with cream-coloured twist knob, cream escutcheon plate with black markings, for installation in 65mm flush mounting boxes and use of Unitas plate. Supplied with flush mounting box: appendix +UP. Maximum number of cells with: M10 FM box 45mm deep 2 FM box 65mm deep 4	UP	X ¹⁾	-	-	-	-	-
Flush mounting version Switch without flush mounting box and special square cover, black markings and cream twist knob. Supplied with flush mounting box: appendix +UP. Max. 4 cells	UP	-	-	X ²⁾	-	-	-

1) Switches are delivered with switch type M10

2) For switch types N20 only





3) For switch types N33F only, max. 3 poles and 3 cells

Base mounting designs

Switches of the designs listed below have protection from front IP40. When a shaft seal (appendix +WD) is used, the front protection type is increased to IP54. In the standard version, the switches are delivered with a square escutcheon plate and black twist knob (design SMA with grey cover and grey toggle knob). Door couplings are advisable for switchgear cabinets with hinged doors.

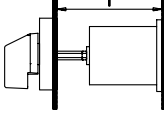
The position of the terminals of the standard switches is left and right, at switch M10H the terminals are above and below. Where a knob insert is turned by 90° (can easily be performed after delivery), the position of the terminals can be changed.

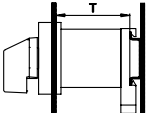
Dimensions see page 76.

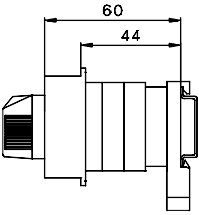
Design	Possible switch sizes	Possible switch sizes					
		Type appendix	M10H	M20	N20 N33F	N40 N60 N80	N100 N200
 <p>Base mounting For screw mounting to the back wall or floor of distributor boxes, or of appliances with removable lids. Additional it is necessary to state the installation depth - that is the distance between mounting level of the switch and the inside edge of the door (dimension T).</p>  <p>Door couplings see page 62</p>	V ... +T/...	X	X	X	X	X	X
 <p>Snap-on mounting on DIN-rail Switch with square escutcheon plate, for snap-on mounting on standard DIN EN 50022 rail. Additional it is necessary to state the installation depth - that is the distance between mounting level of the switch and the inside edge of the door (dimension T).</p>  <p>Door couplings see page 62</p>	SM ... +T/...	X	X	X	-	-	-
 <p>Snap-on mounting on DIN-rail with installation cover for standard opening and toggle knob. The lay-out of the terminals of the standard switches is above and below. Dimensions for Switch types M10H SMA .. with 1-3 cells M20 SMA .. with 1 or 2 cells</p>  <p>further dimensions see page 76</p>	SMA	X	X	-	-	-	-

Plastic enclosed switches

The switches, which have durable plastic enclosures, are intended for wall mounting or attachment to machines. In the standard version, they are supplied with a light-grey enclosure, square escutcheon plate, black markings on a silver background, and a black twist knob. Other colours and colour combinations are available for most enclosure types. It is not possible to mount an additional rectangular plate. The enclosure base is equipped with 4 entry glands with heavy-gauge conduit threads (see drawings). In all types of plastic enclosures, two terminals that are connected and insulated from switch column can be provided for a PE conductor (appendix +PE). In addition, 1 or 2 pilot lamps (appendix +SL..) with neon lights can be installed.

Dimensions see page 77.

Cast aluminium enclosed switches

The switches with cast aluminium enclosures are intended for wall mounting or attachment to machines, under heavy-duty operating conditions. The switches are delivered with a square escutcheon plate, black markings on a silver background, and a black twist knob. It is not possible to mount an additional rectangular plate. The enclosure base makes provision for 2 (4) entry glands with heavy-gauge conduit threads. If a switch with an aluminium enclosure is to be mounted directly on the terminal box of a motor, a 35mm or 50mm hole can be made in the floor of the switch enclosure. Design PLF is the replacement for designs G and GF at types N40 to N80.

Dimensions see page 78.



Design

Description	Type appendix	Possible switch sizes							
		M10H	N20	N33F	N40	N60	N80	N100	N200
Plastic enclosure light grey Protection class IP40 Maximum number of cells	P	X ¹⁾ 6	X 6	X 6	X 6	X 2	-	-	-
Plastic enclosure light grey Moisture protection Protection class IP65 Maximum number of cells	PF	X ¹⁾ 6	X 6	X 6	X 6	X 5	X 5	X 4	X 3
Plastic enclosure horizontal light grey Moisture protection Protection class IP65 Maximum number of cells	PLF	-	-	-	X 10	X 6	X 6	-	-
Cast enclosure Protection class IP40 Maximum number of cells	G	-	X 6	X ²⁾ 5	-	-	-	-	-
Cast enclosure Moisture protection Protection class IP65 Maximum number of cells	GF	-	X 6	X ²⁾ 5	-	-	-	-	-
Terminal box mounting Protection class IP65 These switches are front mounted on a terminal box. The switch cells protrude through a hole into the terminal compartment. Maximum number of cells	KE	X ¹⁾ 12	X 12	X 12	-	-	-	-	-
Plastic motor switch enclosure Moisture protection Protection class IP65 Maximum number of cells	PM	-	X 6	-	-	-	-	-	-

1) Plastic enclosed switches are delivered with switch type M10

2) Cast enclosed switches are delivered with switch type N32

Switching programs

Description	Wiring diagram	Switching angle	Number of cells ↓ Size ↓ AC21	Type	Design see page 6-8 E. Z. V. SMA. P. G.	Switch pro- gram	Escutcheon plate
1-pole		60°	1 48 □ 20A 32A	M10H . x x x x x ¹⁾ - . A1 M20 . x x x x - - . A1		. A1 . A1	
			64 □ 32A 50A	N20 . x - x - x x . A1 N33F . x x x - x x ²⁾ . A1			
			88 □ 63A 80A 115A	N40 . x - x - x - . A1 N60 . x - x - x - . A1 N80 . x - x - - - . A1			
			132 □ 150A 250A	N100 . x - x - - - . A1 N200 . x - x - - - . A1			
			+003				
2-pole		60°	1 48 □ 20A 32A	M10H . x x x x x ¹⁾ - . A2 M20 . x x x x - - . A2		. A2 . A2	
			64 □ 32A 50A	N20 . x - x - x x . A2 N33F . x x x - x x ²⁾ . A2			
			88 □ 63A 80A 115A	N40 . x - x - x - . A2 N60 . x - x - x - . A2 N80 . x - x - - - . A2			
			132 □ 150A 250A	N100 . x - x - - - . A2 N200 . x - x - - - . A2			
			+003				
3-pole		60°	2 48 □ 20A 32A	M10H . x x x x x ¹⁾ - . A3 M20 . x x x x - - . A3		. A3 . A3	
			64 □ 32A 50A	N20 . x - x - x x . A3 N33F . x x x - x x ²⁾ . A3			
			88 □ 63A 80A 115A	N40 . x - x - x - . A3 N60 . x - x - x - . A3 N80 . x - x - - - . A3			
			132 □ 150A 250A	N100 . x - x - - - . A3 N200 . x - x - - - . A3			
			+003				
4-pole 4. pole early make		60°	2 48 □ 20A 32A	M10H . x x x x x ¹⁾ - . A4 M20 . x x x x - - . A4		. A4 . A4	
			64 □ 32A 50A	N20 . x - x - x x . A4 N33F . x - x - x x ²⁾ . A4			
			88 □ 63A 80A 115A	N40 . x - x - x - . A4 N60 . x - x - x - . A4 N80 . x - x - - - . A4			
			132 □ 150A 250A	N100 . x - x - - - . A4 N200 . x - x - - - . A4			
			+003				
6-pole		60°	3 48 □ 20A 32A	M10H . x x x x x ¹⁾ - . A6 M20 . x x x x - - . A6		. A6 . A6	
			64 □ 32A 50A	N20 . x - x - x x . A6 N33F . x - x - x x ²⁾ . A6			
			88 □ 63A 80A 115A	N40 . x - x - x - . A6 N60 . x - x - x - . A6 N80 . x - x - - - . A6			
			132 □ 150A 250A	N100 . x - x - - - . A6 N200 . x - x - - - . A6			
			+003				

Ordering example: AC21 250A panel mounting, On-Off-switch 6-pole, Escutcheon plate OFF - ON

N200 E A6+003

1) Plastic enclosed switches are delivered with switch type M10.

2) Cast enclosed switches are delivered with switch type N32.

Switching programs

Description	Wiring diagram	Switching angle	Number of cells ↓ Size ↓ AC21	Type	Design see page 6-8 E. Z. V. SMA. P. G.	Switch pro- gram	Escutcheon plate
Changeover switches U							
1-pole		60°	1 48 □ 20A 32A	M10H . M20 .	x x x x x ¹⁾ x x x x - -	. U1 . U1	
			64 □ 32A 50A	N20 . N33F .	x - x - x x x x x - x x ²⁾	. U1 . U1	
			88 □ 63A 80A 115A	N40 . N60 . N80 .	x - x - x - x - x - x - x - x - - -	. U1 . U1 . U1	
			132 □ 150A 250A	N100 . N200 .	x - x - - - x - x - - -	. U1 . U1	
							+007
2-pole		60°	2 48 □ 20A 32A	M10H . M20 .	x x x x x ¹⁾ - x x x x - -	. U2 . U2	
			64 □ 32A 50A	N20 . N33F .	x - x - x x x x x - x x ²⁾	. U2 . U2	
			88 □ 63A 80A 115A	N40 . N60 . N80 .	x - x - x - x - x - x - x - x - - -	. U2 . U2 . U2	
			132 □ 150A 250A	N100 . N200 .	x - x - - - x - x - - -	. U2 . U2	
							+007
3-pole		60°	3 48 □ 20A 32A	M10H . M20 .	x x x x x ¹⁾ - x x x x - -	. U3 . U3	
			64 □ 32A 50A	N20 . N33F .	x - x - x x x x x - x x ²⁾	. U3 . U3	
			88 □ 63A 80A 115A	N40 . N60 . N80 .	x - x - x - x - x - x - x - x - - -	. U3 . U3 . U3	
			132 □ 150A 250A	N100 . N200 .	x - x - - - x - x - - -	. U3 . U3	
							+007
4-pole 4. pole early make		60°	4 48 □ 20A 32A	M10H . M20 .	x x x x x ¹⁾ - x x x x - -	. U4 . U4	
			64 □ 32A 50A	N20 . N33F .	x - x - x x x - x - x x ²⁾	. U4 . U4	
			88 □ 63A 80A 115A	N40 . N60 . N80 .	x - x - x - x - x - x - x - x - - -	. U4 . U4 . U4	
			132 □ 150A 250A	N100 . N200 .	x - x - - - x - x - - -	. U4 . U4	
							+007
6-pole		60°	6 48 □ 20A 32A	M10H . M20 .	x x x - x ¹⁾ - x x x - - -	. U6 . U6	
			64 □ 32A 50A	N20 . N33F .	x - x - x x x - x - x -	. U6 . U6	
			88 □ 63A 80A 115A	N40 . N60 . N80 .	x - x - x - x - x - x - x - x - - -	. U6 . U6 . U6	
			132 □ 150A 250A	N100 . N200 .	x - x - - - x - x - - -	. U6 . U6	
							+007

Ordering example: AC21 250A panel mounting, changeover switch 6-pole, Escutcheon plate 1 - OFF - 2 **N200 E U6+007**

1) Plastic enclosed switches are delivered with switch type M10.

2) Cast enclosed switches are delivered with switch type N32.

Switching programs

Description	Wiring diagram	Switching angle	Number of cells ↓ Size ↓ AC21	Type	Design see page 6-8 E. Z. V. SMA. P. G.	Switch pro- gram	Escutcheon plate
Changeover switches without off W							
1-pole		60°	1	48 □ 20A 32A	M10H . x x x x x ¹⁾ - . W1 M20 . x x x x - - . W1		
				64 □ 32A 50A	N20 . x - x - x x . W1 N33F . x x x - x x ²⁾ . W1		
				88 □ 63A 80A 115A	N40 . x - x - x - . W1 N60 . x - x - x - . W1 N80 . x - x - - - . W1		
				132 □ 150A 250A	N100 . x - x - - - . W1 N200 . x - x - - - . W1		
2-pole		60°	2	48 □ 20A 32A	M10H . x x x x x ¹⁾ - . W2 M20 . x x x x - - . W2		
				64 □ 32A 50A	N20 . x - x - x x . W2 N33F . x x x - x x ²⁾ . W2		
				88 □ 63A 80A 115A	N40 . x - x - x - . W2 N60 . x - x - x - . W2 N80 . x - x - - - . W2		
				132 □ 150A 250A	N100 . x - x - - - . W2 N200 . x - x - - - . W2		
3-pole		60°	3	48 □ 20A 32A	M10H . x x x x x ¹⁾ - . W3 M20 . x x x x - - . W3		
				64 □ 32A 50A	N20 . x - x - x x . W3 N33F . x x x - x x ²⁾ . W3		
				88 □ 63A 80A 115A	N40 . x - x - x - . W3 N60 . x - x - x - . W3 N80 . x - x - - - . W3		
				132 □ 150A 250A	N100 . x - x - - - . W3 N200 . x - x - - - . W3		
4-pole 4. pole early make		60°	4	48 □ 20A 32A	M10H . x x x x x ¹⁾ - . W4 M20 . x x x x - - . W4		
				64 □ 32A 50A	N20 . x - x - x x . W4 N33F . x - x - x x ²⁾ . W4		
				88 □ 63A 80A 115A	N40 . x - x - x - . W4 N60 . x - x - x - . W4 N80 . x - x - - - . W4		
				132 □ 150A 250A	N100 . x - x - - - . W4 N200 . x - x - - - . W4		
6-pole		60°	6	48 □ 20A 32A	M10H . x x x - x ¹⁾ - . W6 M20 . x x x - - - . W6		
				64 □ 32A 50A	N20 . x - x - x x . W6 N33F . x - x - x - . W6		
				88 □ 63A 80A 115A	N40 . x - x - x - . W6 N60 . x - x - x - . W6 N80 . x - x - - - . W6		
				132 □ 150A 250A	N100 . x - x - - - . W6 N200 . x - x - - - . W6		

Ordering example: AC21 250A panel mounting, changeover switch without off 6-pole,

N200 E W6

1) Plastic enclosed switches are delivered with switch type M10.

2) Cast enclosed switches are delivered with switch type N32.

Switching programs

Description	Wiring diagram	Switching angle	Number of cells ↓ Size ↓ AC21	Type	Design see page 6-8 E. Z. V. SMA. P. G.	Switch pro- gram	Escutcheon plate
Reversing switches WU							
2-pole		60°	2	48 □ 20A	M10H . x x x x x ¹⁾ - . WU2	. WU2	
				32A	M20 . x x x x - - . WU2		
				64 □ 32A	N20 . x - x - x x . WU2		
				50A	N33F . x x x - x x ²⁾ . WU2		
				88 □ 63A	N40 . x - x - x - . WU2		
80A	N60 . x - x - x - . WU2						
115A	N80 . x - x - - - . WU2						
132 □ 150A	N100 . x - x - - - . WU2						
250A	N200 . x - x - - - . WU2						
2-pole without off cross switch		60°	2	48 □ 20A	M10H . x x x x x ¹⁾ - . WK2	. WK2	
				32A	M20 . x x x x - - . WK2		
				64 □ 32A	N20 . x - x - x x . WK2		
				50A	N33F . x x x - x x ²⁾ . WK2		
				88 □ 63A	N40 . x x - x - . WK2		
80A	N60 . x - x - x - . WK2						
115A	N80 . x - x - - - . WK2						
132 □ 150A	N100 . x - x - - - . WK2						
250A	N200 . x - x - - - . WK2						
2-pole with spring return from both sides to off		30°	2	48 □ 20A	M10H . x x x x x ¹⁾ - . WU2R2	. WU2R2	
				32A	M20 . x x x x - - . WU2R2		
				64 □ 32A	N20 . x - x - x x . WU2R2		
50A	N33F . x x x - x x ²⁾ . WU2R2						
88 □ 63A	N40 . x - x - x - . WU2R2						
2-pole position 1 latched position 2 with spring return to off		60°+30°	2	48 □ 20A	M10H . x x x x x ¹⁾ - . WU2R1	. WU2R1	
				32A	M20 . x x x x - - . WU2R1		
				64 □ 32A	N20 . x - x - x x . WU2R1		
50A	N33F . x x x - x x ²⁾ . WU2R1						
88 □ 63A	N40 . x - x - x - . WU2R1						
3-pole		60°	3	48 □ 20A	M10H . x x x x x ¹⁾ - . WU3	. WU3	
				32A	M20 . x x x x - - . WU3		
				64 □ 32A	N20 . x - x - x x . WU3		
				50A	N33F . x x x - x x ²⁾ . WU3		
				88 □ 63A	N40 . x - x - x - . WU3		
80A	N60 . x - x - x - . WU3						
115A	N80 . x - x - - - . WU3						
132 □ 150A	N100 . x - x - - - . WU3						
250A	N200 . x - x - - - . WU3						
3-pole with spring return from both sides to off		30°	3	48 □ 20A	M10H . x x x x x ¹⁾ - . WU3R2	. WU3R2	
				32A	M20 . x x x x - - . WU3R2		
				64 □ 32A	N20 . x - x - x x . WU3R2		
50A	N33F . x x x - x x ²⁾ . WU3R2						
88 □ 63A	N40 . x - x x - . WU3R2						
3-pole position 1 latched position 2 with spring return to off		60°+30°	3	48 □ 20A	M10H . x x x x x ¹⁾ - . WU3R1	. WU3R1	
				32A	M20 . x x x x - - . WU3R1		
				64 □ 32A	N20 . x - x - x x . WU3R1		
50A	N33F . x - x - x x ²⁾ . WU3R1						
88 □ 63A	N40 . x - x - x - . WU3R1						

Ordering example: AC21 63A base mounting, reversing switch 3-pole, position 2 with spring to off N40 V WU3R1

1) Plastic enclosed switches are delivered with switch type M10.

2) Cast enclosed switches are delivered with switch type N32.

Switching programs

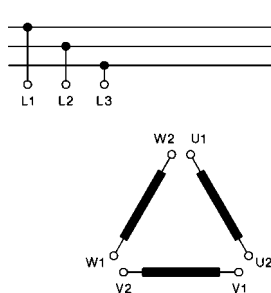
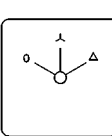
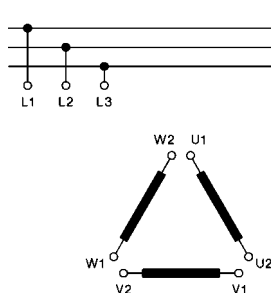
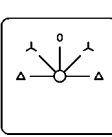
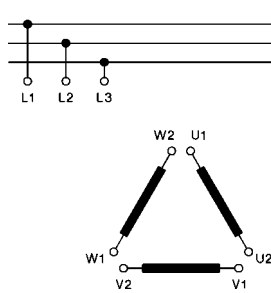
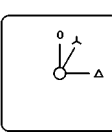
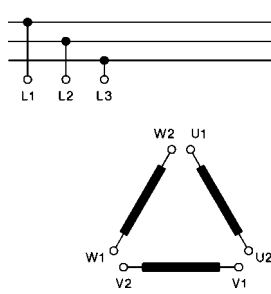
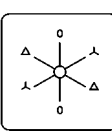
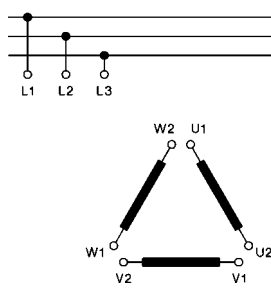
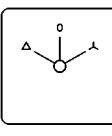
Description	Wiring diagram	Switching angle	Number of cells ↓ Size ↓ AC21	Type	Design see page 6-8 E. Z. V. SMA. P. G.	Switch pro- gram	Escutcheon plate
<p>1 rotary direction</p> 	60°	4	48 □ 20A 32A 64 □ 32A 50A 88 □ 63A 80A 115A 132 □ 150A 250A	M10H . x x x x x ¹⁾ - . SD M20 . x x x x - - . SD N20 . x - x - x x . SD N33F . x - x - x x ²⁾ . SD N40 . x - x - x - . SD N60 . x - x - x - . SD N80 . x - x - - - . SD N100 . x - x - - - . SD N200 . x - x - - - . SD			
<p>both rotary directions</p> 	45°	5	48 □ 20A 32A 64 □ 32A 50A 88 □ 63A 80A 115A 132 □ 150A 250A	M10H . x x x x x ¹⁾ - . SDR M20 . x x x x - - . SDR N20 . x - x - x x . SDR N33F . x - x - x x ²⁾ . SDR N40 . x - x - x - . SDR N60 . x - x - x - . SDR N80 . x - x - - - . SDR N100 . x - x - - - . SDR N200 . x - x - - - . SDR			
<p>1 rotary direction spring return from Δ to 0</p> 	60°	4	48 □ 20A 32A 64 □ 32A 50A 88 □ 63A 80A 115A 132 □ 150A 250A	M10H . x x x x x ¹⁾ - . SRD M20 . x x x x - - . SRD N20 . x - x - x x . SRD N33F . x - x - x x ²⁾ . SRD N40 . x - x - x - . SRD N60 . x - x - x - . SRD N80 . x - x - - - . SRD N100 . x - x - - - . SRD N200 . x - x - - - . SRD			
<p>1 rotary direction with clockwise operation and backswitch interlock</p> 	60°	5	48 □ 20A 32A 64 □ 32A 50A 88 □ 63A 80A 115A 132 □ 150A 250A	M10H . x x x x x ¹⁾ - . SDRU M20 . x x x x - - . SDRU N20 . x - x - x x . SDRU N33F . x - x - x x ²⁾ . SDRU N40 . x - x - x - . SDRU N60 . x - x - x - . SDRU N80 . x - x - - - . SDRU N100 . x - x - - - . SDRU N200 . x - x - - - . SDRU			
<p>Star-Delta selector switch</p> 	60°	4	48 □ 20A 32A 64 □ 32A 50A 88 □ 63A 80A 115A 132 □ 150A 250A	M10H . x x x x x ¹⁾ - . SDU M20 . x x x x - - . SDU N20 . x - x - x x . SDU N33F . x - x - x x ²⁾ . SDU N40 . x - x - x - . SDU N60 . x - x - x - . SDU N80 . x - x - - - . SDU N100 . x - x - - - . SDU N200 . x - x - - - . SDU			

Ordering example: AC21 32A cast enclosed, star-delta selector switch

N20 G SDU

1) Plastic enclosed switches are delivered with switch type M10.

2) Cast enclosed switches are delivered with switch type N32.

Switching programs

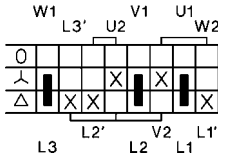
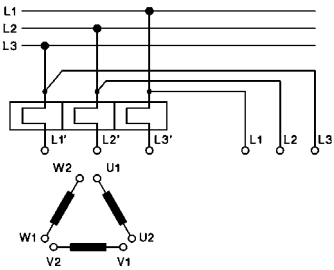
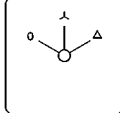
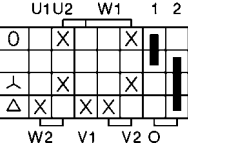
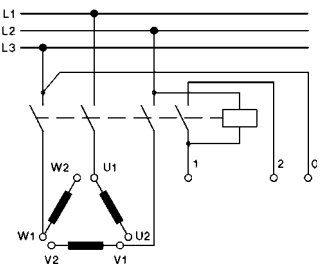
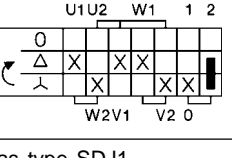
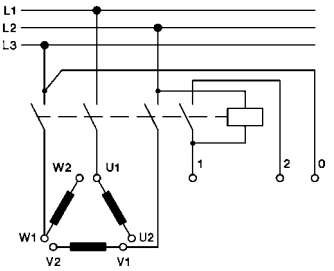
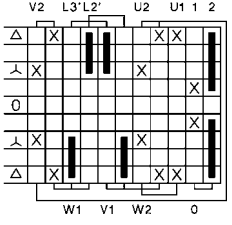
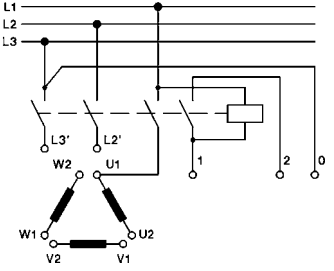
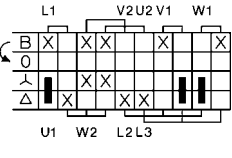
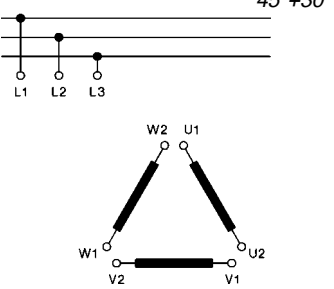
Description	Wiring diagram	Switching angle	Number of cells ↓ Size ↓ AC21	Type	Design see page 6-8 E. Z. V. SMA. P. G.	Switch pro- gram	Escutcheon plate
with double outfeed phases for use with manual motor starter 		60°	4	48 □ 20A 32A	M10H . x x x x x ¹⁾ - . SDMO M20 . x x x x - - . SDMO		
			64 □	32A 50A	N20 . x - x - x x . SDMO N33F . x - x - x x ²⁾ . SDMO		
			88 □	63A 80A 115A	N40 . x - x - x - . SDMO N60 . x - x - x - . SDMO N80 . x - x - - - . SDMO		
			132 □	150A 250A	N100 . x - x - - - . SDMO N200 . x - x - - - . SDMO		
			with auxiliary contacts for contactor control, without main contacts, automatic zero setting in event of mains break-down 		90°		4
64 □	32A 50A	N20 . x - x - x x . SDJ1 N33F . x - x - x x ²⁾ . SDJ1					
88 □	63A 80A 115A	N40 . x - x - x - . SDJ1 N60 . x - x - x - . SDJ1 N80 . x - x - - - . SDJ1					
132 □	150A 250A	N100 . x - x - - - . SDJ1 N200 . x - x - - - . SDJ1					
with auxiliary contacts for contactor control, without main contacts, automatic zero setting in event of mains break-down, spring return to 		90°+30°				4	48 □ 20A 32A
			64 □	32A 50A	N20 . x - x - x x . SDJ2 N33F . x - x - x x ²⁾ . SDJ2		
			88 □	63A 80A 115A	N40 . x - x - x - . SDJ2 N60 . x - x - x - . SDJ2 N80 . x - x - - - . SDJ2		
			132 □	150A 250A	N100 . x - x - - - . SDJ2 N200 . x - x - - - . SDJ2		
			as type SDJ1 but for both rotary directions 		60°	7	48 □ 20A 32A
64 □	32A 50A	N20 . x - x - x x . SDRJ1 N33F . x - x - - - . SDRJ1					
88 □	63A 80A 115A	N40 . x - x - x - . SDRJ1 N60 . x - x - - - . SDRJ1 N80 . x - x - - - . SDRJ1					
132 □	150A 250A	N100 . x - x - - - . SDRJ1 N200 . x - x - - - . SDRJ1					
with brake position (counter current braking) brake position is a momentary operation 		45°+30°				5	48 □ 20A 32A
			64 □	32A 50A	N20 . x - x - x x . SDB N33F . x - x - x x ²⁾ . SDB		
			88 □	63A 80A 115A	N40 . x - x - x - . SDB N60 . x - x - x - . SDB N80 . x - x - - - . SDB		
			132 □	150A 250A	N100 . x - x - - - . SDB N200 . x - x - - - . SDB		

Ordering example: AC21 250A panel mounting star-delta switch with brake position N200 E SDB

1) Plastic enclosed switches are delivered with switch type M10.

2) Cast enclosed switches are delivered with switch type N32.

Switching programs

Description	Wiring diagram	Switching angle	Number of cells ↓ Size ↓ AC21	Type	Design see page 6-8 E. Z. V. SMA. P. G.	Switch pro- gram	Escutcheon plate
for starting up single-phase motors with split-phase, spring return from START to Off		30°+60°	2 48 □ 20A	M10H . x x x x x ¹⁾ - . HP1	M20 . x x x x - - . HP1		
			64 □ 32A	N20 . x - x - x x . HP1	N33F . x - x - x x ²⁾ . HP1		
			88 □ 63A	N40 . x - x - x - . HP1			
for starting up single-phase motors with split-phase, spring return from START to 1		90°+30°	2 48 □ 20A	M10H . x x x x x ¹⁾ - . HP2	M20 . x x x x - - . HP2		
			64 □ 32A	N20 . x - x - x x . HP2	N33F . x - x - x x ²⁾ . HP2		
			88 □ 63A	N40 . x - x - x - . HP2			
for starting up single-phase motors with split-phase, both rotary directions		60°+30°	3 48 □ 20A	M10H . x x x x x ¹⁾ - . HPR1	M20 . x x x x - - . HPR1		
			64 □ 32A	N20 . x - x - x x . HPR1	N33F . x - x - x x ²⁾ . HPR1		
			88 □ 63A	N40 . x - x - x - . HPR1			
as type HPR1 with starting and phase-shifting capacitor		60°+30°	4 48 □ 20A	M10H . x x x x x ¹⁾ - . HPR2	M20 . x x x x - - . HPR2		
			64 □ 32A	N20 . x - x - x x . HPR2	N33F . x - x - x x ²⁾ . HPR2		
			88 □ 63A	N40 . x - x - x - . HPR2			

Ordering example: AC21 63A panel mounting, split phase switch, both rotary directions **N40 E HPR1**

1) Plastic enclosed switches are delivered with switch type M10.

2) Cast enclosed switches are delivered with switch type N32.

Switching programs

Description	Wiring diagram	Switching angle	Number of cells ↓ Size ↓ AC21	Type	Design see page 6-8 E. Z. V. SMA. P. G.	Switch pro- gram	Escutcheon plate
-------------	----------------	-----------------	--	------	--	------------------------	---------------------

Multi speed switches P

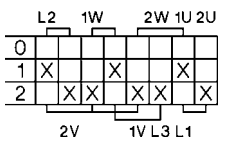
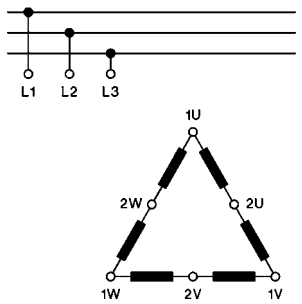
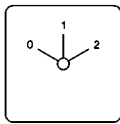
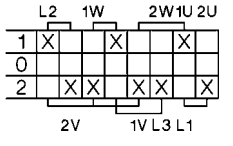
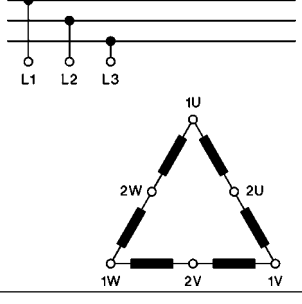
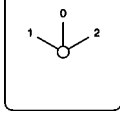
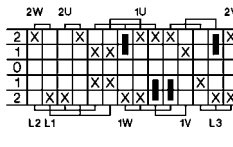
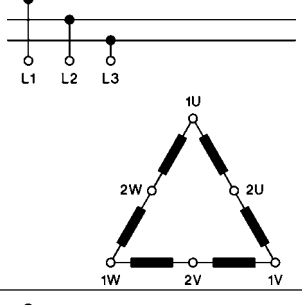
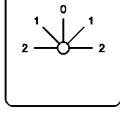
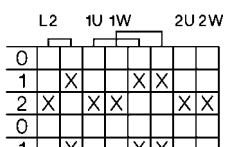
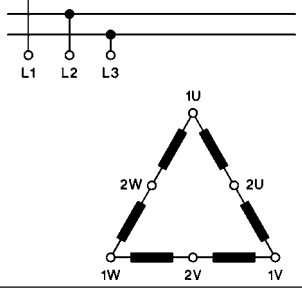
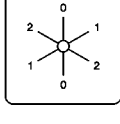
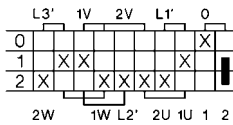
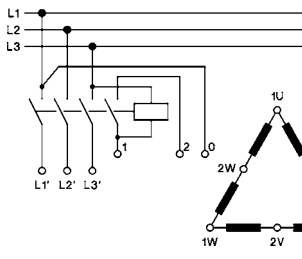
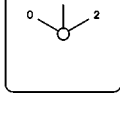
1 Dahlander winding 1 rotary direction 		60°	4	48 □ 20A	M10H . x x x x x ¹⁾ - . P61 M20 . x x x x - - . P61	
				64 □ 32A	N20 . x - x - x x . P61 N33F . x - x - x x ²⁾ . P61	
				88 □ 63A 80A 115A	N40 . x - x - x - . P61 N60 . x - x - x - . P61 N80 . x - x - - - . P61	
				132 □ 150A 250A	N100 . x - x - - - . P61 N200 . x - x - - - . P61	
1 Dahlander winding 1 rotary direction 		60°	4	48 □ 20A	M10H . x x x x x ¹⁾ - . P62 M20 . x x x x - - . P62	
				64 □ 32A	N20 . x - x - x x . P62 N33F . x - x - x x ²⁾ . P62	
				88 □ 63A 80A 115A	N40 . x - x - x - . P62 N60 . x - x - x - . P62 N80 . x - x - - - . P62	
				132 □ 150A 250A	N100 . x - x - - - . P62 N200 . x - x - - - . P62	
1 Dahlander winding both rotary directions 		0°	7	48 □ 20A	M10H . x x x - - - . P61R M20 . x x x - - - . P61R	
				64 □ 32A	N20 . x - x - x - . P61R N33F . x - x - - - . P61R	
				88 □ 63A 80A 115A	N40 . x - x - x - . P61R N60 . x - x - - - . P61R N80 . x - x - - - . P61R	
				132 □ 150A 250A	N100 . x - x - - - . P61R N200 . x - x - - - . P61R	
1 Dahlander winding 1 rotary direction, clockwise operation 		60°	5	48 □ 20A	M10H . x x x x x ¹⁾ - . P61RU M20 . x x x x - - . P61RU	
				64 □ 32A	N20 . x - x - x x . P61RU N33F . x - x - x x ²⁾ . P61RU	
				88 □ 63A 80A 115A	N40 . x - x - x - . P61RU N60 . x - x - x - . P61RU N80 . x - x - - - . P61RU	
				132 □ 150A 250A	N100 . x - x - - - . P61RU N200 . x - x - - - . P61RU	
1 Dahlander winding 1 rotary direction, with auxiliary contacts for contactor control 		60°	5	48 □ 20A	M10H . x x x x x ¹⁾ - . P61J M20 . x x x x - - . P61J	
				64 □ 32A	N20 . x - x - x x . P61J N33F . x - x - x x ²⁾ . P61J	
				88 □ 63A 80A 115A	N40 . x - x - x - . P61J N60 . x - x - x - . P61J N80 . x - x - - - . P61J	
				132 □ 150A 250A	N100 . x - x - - - . P61J N200 . x - x - - - . P61J	

Ordering example: AC21 32A cast enclosed, multi speed switch, 1 Dahlander winding, 1 rotary direction **N20 G P61**

1) Plastic enclosed switches are delivered with switch type M10.

2) Cast enclosed switches are delivered with switch type N32.

Switching programs

Description Schaltbild	Wiring diagram	Switching angle	Number of cells ↓ Size ↓ AC21	Type	Design see page 6-8 E. Z. V. SMA. P. G.	Switch pro- gram	Escutcheon plate
---------------------------	----------------	-----------------	---	------	---	------------------------	---------------------

Multi speed switches P

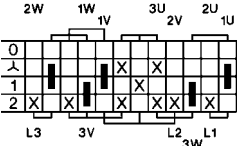
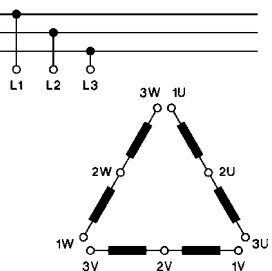
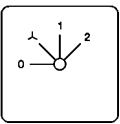
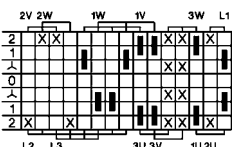
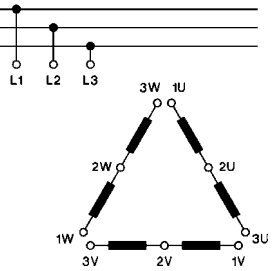
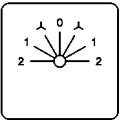
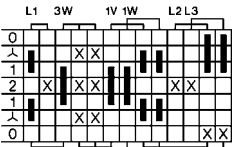
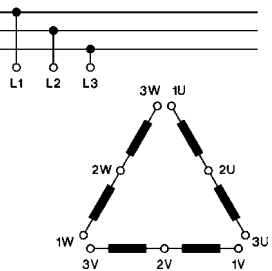
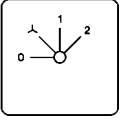
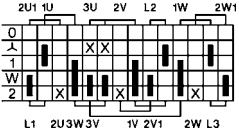
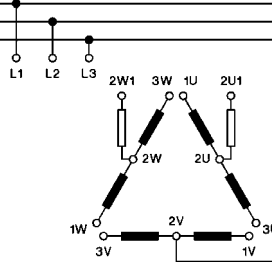
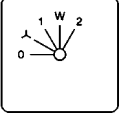
open Dahlander winding 1 rotary direction low speed with star-delta-start 		45°	6	48 □ 20A 32A	M10H . x x x - x ¹⁾ - . P91 M20 . x x x - - - . P91	
			64 □	32A 50A	N20 . x - x - x x . P91 N33F . x - x - x - . P91	
			88 □	63A 80A 115A	N40 . x - x - x - . P91 N60 . x - x - x - . P91 N80 . x - x - - - . P91	
			132 □	150A 250A	N100 . x - x - - - . P91 N200 . x - x - - - . P91	
open Dahlander winding both rotary directions low speed with star-delta-start 		30°	8	48 □ 20A 32A	M10H . x x x - - - . P91R M20 . x x x - - - . P91R	
			64 □	32A 50A	N20 . x - x - x - . P91R N33F . x - x - - - . P91R	
			88 □	63A 80A 115A	N40 . x - x - x - . P91R N60 . x - x - - - . P91R N80 . x - x - - - . P91R	
			132 □	150A 250A	N100 . x - x - - - . P91R N200 . x - x - - - . P91R	
same as type P91 no load return from 2 to Off 		45°	10	48 □ 20A 32A	M10H . - - - - - . P91S M20 . - - - - - . P91S	
			64 □	32A 50A	N20 . x - x - - - . P91S N33F . x - x - - - . P91S	
			88 □	63A 80A 115A	N40 . x - x - - - . P91S N60 . x - x - - - . P91S N80 . x - x - - - . P91S	
			132 □	150A 250A	N100 . - - - - - . P91S N200 . - - - - - . P91S	
open Dahlander winding 1 rotary direction, low speed with star-delta-start, with additional start position (starting resistor) 		30°	7	48 □ 20A 32A	M10H . x x x - - - . P91W M20 . x x x - - - . P91W	
			64 □	32A 50A	N20 . x - x - x - . P91W N33F . x - x - - - . P91W	
			88 □	63A 80A 115A	N40 . x - x - x - . P91W N60 . x - x - - - . P91W N80 . x - x - - - . P91W	
			132 □	150A 250A	N100 . x - x - - - . P91W N200 . x - x - - - . P91W	

Ordering example: AC21 250A panel mounting, multi speed switch, 1 rotary direction, low speed with star-delta-start N200 E P91

1) Plastic enclosed switches are delivered with switch type M10.

2) Cast enclosed switches are delivered with switch type N32.

Switching programs

Description	Wiring diagram	Switching angle	Number of cells ↓ Size ↓ AC21	Type	Design see page 6-8 E. Z. V. SMA. P. G.	Switch pro- gram	Escutcheon plate
-------------	----------------	-----------------	---	------	---	------------------------	---------------------

Multi speed switches P

2 separate windings 1 rotary direction 	60°	3	48 □ 20A 32A	M10H . x x x x x ¹⁾ - . P63 M20 . x x x x - - . P63	
			64 □ 32A 50A	N20 . x - x - x x . P63 N33F . x - x - x x ²⁾ . P63	
			88 □ 63A 80A 115A	N40 . x - x - x - . P63 N60 . x - x - x - . P63 N80 . x - x - - - . P63	
			132 □ 150A 250A	N100 . x - x - - - . P63 N200 . x - x - - - . P63	
2 separate windings 1 rotary direction 	60°	3	48 □ 20A 32A	M10H . x x x x x ¹⁾ - . P64 M20 . x x x x - - . P64	
			64 □ 32A 50A	N20 . x - x - x x . P64 N33F . x - x - x x ²⁾ . P64	
			88 □ 63A 80A 115A	N40 . x - x - x - . P64 N60 . x - x - x - . P64 N80 . x - x - - - . P64	
			132 □ 150A 250A	N100 . x - x - - - . P64 N200 . x - x - - - . P64	
2 separate windings both rotary directions 	60°	5	48 □ 20A 32A	M10H . x x x x x ¹⁾ - . P66 M20 . x x x x - - . P66	
			64 □ 32A 50A	N20 . x - x - x x . P66 N33F . x - x - x x ²⁾ . P66	
			88 □ 63A 80A 115A	N40 . x - x - x - . P66 N60 . x - x - x - . P66 N80 . x - x - - - . P66	
			132 □ 150A 250A	N100 . x - x - - - . P66 N200 . x - x - - - . P66	
2 separate windings 1 opened 1 rotary direction 	60°	4	48 □ 20A 32A	M10H . x x x x x ¹⁾ - . P71 M20 . x x x x - - . P71	
			64 □ 32A 50A	N20 . x - x - x x . P71 N33F . x - x - x x ²⁾ . P71	
			88 □ 63A 80A 115A	N40 . x - x - x - . P71 N60 . x - x - x - . P71 N80 . x - x - - - . P71	
			132 □ 150A 250A	N100 . x - x - - - . P71 N200 . x - x - - - . P71	
2 separate windings 1 rotary direction low speed with star-delta-start 	45°	6	48 □ 20A 32A	M10H . x x x - x ¹⁾ - . P96 M20 . x x x - - - . P96	
			64 □ 32A 50A	N20 . x - x - x x . P96 N33F . x - x - x - . P96	
			88 □ 63A 80A 115A	N40 . x - x - x - . P96 N60 . x - x - x - . P96 N80 . x - x - - - . P96	
			132 □ 150A 250A	N100 . x - x - - - . P96 N200 . x - x - - - . P96	

Ordering example: AC21 250A panel mounting, multi speed switch, 2 separate windings, low speed with star-delta-start **N200 E P96**

1) Plastic enclosed switches are delivered with switch type M10.

2) Cast enclosed switches are delivered with switch type N32.

Switching programs

Description	Wiring diagram	Switching angle	Number of cells ↓ Size ↓ AC21	Type	Design see page 6-8 E. Z. V. SMA. P. G.	Switch pro- gram	Escutcheon plate
-------------	----------------	-----------------	--	------	--	------------------------	---------------------

Multi speed switches P

<p>2 separate windings 1 rotary direction both speeds with star-delta-start</p>	<p>45°</p>	<p>8</p>	<p>48 □ 20A 32A</p>	<p>M10H . x x x - - - . P122 M20 . x x x - - - . P122</p>	
			<p>64 □ 32A 50A</p>	<p>N20 . x - x - x - . P122 N33F . x - x - - - . P122</p>	
			<p>88 □ 63A 80A 115A</p>	<p>N40 . x - x - x - . P122 N60 . x - x - - - . P122 N80 . x - x - - - . P122</p>	
			<p>132 □ 150A 250A</p>	<p>N100 . x - x - - - . P122 N200 . x - x - - - . P122</p>	
<p>1 Dahlander winding A 1 normal winding B 3 speeds 1 rotary direction 0-A Δ-B Δ or Δ-A Δ</p>	<p>45°</p>	<p>6</p>	<p>48 □ 20A 32A</p>	<p>M10H . x x x - x¹⁾ - . P93 M20 . x x x - - - . P93</p>	
			<p>64 □ 32A 50A</p>	<p>N20 . x - x - x x . P93 N33F . x - x - x - . P93</p>	
			<p>88 □ 63A 80A 115A</p>	<p>N40 . x - x - x - . P93 N60 . x - x - x - . P93 N80 . x - x - - - . P93</p>	
			<p>132 □ 150A 250A</p>	<p>N100 . x - x - - - . P93 N200 . x - x - - - . P93</p>	
<p>1 Dahlander winding A 1 normal winding B 3 speeds 1 rotary direction 0-B Δ or Δ-A Δ</p>	<p>45°</p>	<p>6</p>	<p>48 □ 20A 32A</p>	<p>M10H . x x x - x¹⁾ - . P94 M20 . x x x - - - . P94</p>	
			<p>64 □ 32A 50A</p>	<p>N20 . x - x - x - . P94 N33F . x - x - x - . P94</p>	
			<p>88 □ 63A 80A 115A</p>	<p>N40 . x - x - x - . P94 N60 . x - x - x - . P94 N80 . x - x - - - . P94</p>	
			<p>132 □ 150A 250A</p>	<p>N100 . x - x - - - . P94 N200 . x - x - - - . P94</p>	
<p>1 Dahlander winding A 1 normal winding B 3 speeds 1 rotary direction 0-A Δ-A Δ-B Δ or Δ</p>	<p>45°</p>	<p>6</p>	<p>48 □ 20A 32A</p>	<p>M10H . x x x - x¹⁾ - . P95 M20 . x x x - - - . P95</p>	
			<p>64 □ 32A 50A</p>	<p>N20 . x - x - x x . P95 N33F . x - x - x - . P95</p>	
			<p>88 □ 63A 80A 115A</p>	<p>N40 . x - x - x - . P95 N60 . x - x - x - . P95 N80 . x - x - - - . P95</p>	
			<p>132 □ 150A 250A</p>	<p>N100 . x - x - - - . P95 N200 . x - x - - - . P95</p>	
<p>1 Dahlander winding A 1 normal winding B 3 speeds both rotary directions</p>	<p>45°</p>	<p>9</p>	<p>48 □ 20A 32A</p>	<p>M10H . x x x - - - . P93R M20 . x x x - - - . P93R</p>	
			<p>64 □ 32A 50A</p>	<p>N20 . x - x - - - . P93R N33F . x - x - - - . P93R</p>	
			<p>88 □ 63A 80A 115A</p>	<p>N40 . x - x - - - . P93R N60 . x - x - - - . P93R N80 . x - x - - - . P93R</p>	
			<p>132 □ 150A 250A</p>	<p>N100 . x - x - - - . P93R N200 . x - x - - - . P93R</p>	

Ordering example: AC21 250A panel mounting, multi speed switch, 1 Dahlander winding A,
1 normal winding B, 3 speeds, both rotary directions **N200 E P93R**

- 1) Plastic enclosed switches are delivered with switch type M10.
- 2) Cast enclosed switches are delivered with switch type N32.

Switching programs

Description	Wiring diagram	Switching angle	Number of cells ↓ Size ↓ AC21	Type	Design see page 6-8 E. Z. V. SMA. P. G.	Switch pro- gram	Escutcheon plate
-------------	----------------	-----------------	---	------	---	------------------------	---------------------

Multi speed switches P

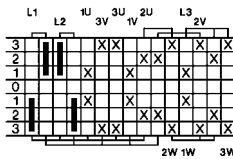
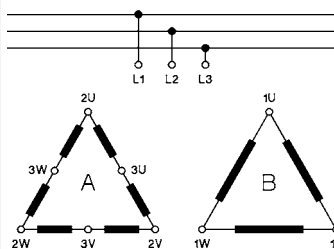
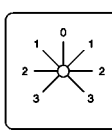
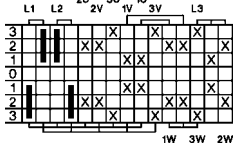
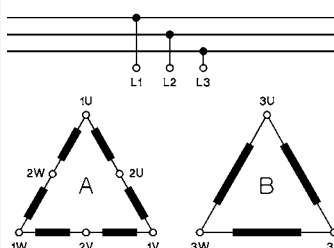
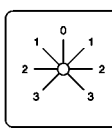
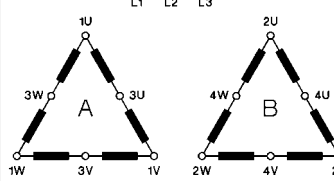
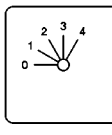
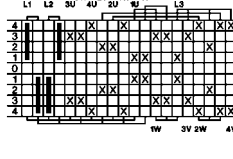
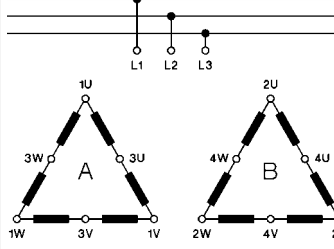
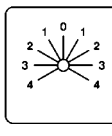
1 Dahlander winding A 1 normal winding B 3 speeds both rotary directions 		45°	9 48 □ 20A 32A	M10H . x x x - - - . P94R M20 . x x x - - - . P94R	
			64 □ 32A 50A	N20 . x - x - - - . P94R N33F . x - x - - - . P94R	
			88 □ 63A 80A 115A	N40 . x - x - - - . P94R N60 . x - x - - - . P94R N80 . x - x - - - . P94R	
			132 □ 150A 250A	N100 . x - x - - - . P94R N200 . x - x - - - . P94R	
1 Dahlander winding A 1 normal winding B 3 speeds both rotary directions 		45°	8 48 □ 20A 32A	M10H . x x x - - - . P95R M20 . x x x - - - . P95R	
			64 □ 32A 50A	N20 . x - x - x - . P95R N33F . x - x - - - . P95R	
			88 □ 63A 80A 115A	N40 . x - x - x - . P95R N60 . x - x - - - . P95R N80 . x - x - - - . P95R	
			132 □ 150A 250A	N100 . x - x - - - . P95R N200 . x - x - - - . P95R	
2 Dahlander windings 4 speeds 1 rotary direction 0 - A Δ - B Δ - A Δ - B Δ		30°	8 48 □ 20A 32A	M10H . x x x - - - . P124 M20 . x x x - - - . P124	
			64 □ 32A 50A	N20 . x - x - x - . P124 N33F . x - x - - - . P124	
			88 □ 63A 80A 115A	N40 . x - x - x - . P124 N60 . x - x - - - . P124 N80 . x - x - - - . P124	
			132 □ 150A 250A	N100 . x - x - - - . P124 N200 . x - x - - - . P124	
2 Dahlander windings 4 speeds both rotary directions 		30°	12 48 □ 20A 32A	M10H . x x x - - - . P124R M20 . x x x - - - . P124R	
			64 □ 32A 50A	N20 . x - x - - - . P124R N33F . x - x - - - . P124R	
			88 □ 63A 80A 115A	N40 . x - x - - - . P124R N60 . x - x - - - . P124R N80 . x - x - - - . P124R	
			132 □ 150A 250A	N100 . x - x - - - . P124R N200 . x - x - - - . P124R	

Ordering example: AC21 250A Base mounting, multi speed switch, 2 Dahlander windings, 4 speeds, 1 rotary direction **N200 V P124**

Switching programs

Description	Wiring diagram	Switching angle	Number of cells ↓ Size ↓ AC21	Type	Design see page 6-8 E. Z. V. SMA. P. G.	Switch pro- gram	Escutcheon plate
-------------	----------------	-----------------	---	------	---	------------------------	---------------------

Changeover switches with spring return to off UR

1-pole		30°	1 48 □ 20A 32A	M10H . x x x x x ¹⁾ - . UR1 M20 . x x x x - - . UR1	
			64 □ 32A 50A	N20 . x - x - x x . UR1 N33F . x - x - x x ²⁾ . UR1	
			88 □ 63A	N40 . x - x - x - . UR1	
2-pole		30°	2 48 □ 20A 32A	M10H . x x x x x ¹⁾ - . UR2 M20 . x x x x - - . UR2	
			64 □ 32A 50A	N20 . x - x - x x . UR2 N33F . x - x - x x ²⁾ . UR2	
			88 □ 63A	N40 . x - x - x - . UR2	
3-pole		30°	3 48 □ 20A 32A	M10H . x x x x x ¹⁾ - . UR3 M20 . x x x x - - . UR3	
			64 □ 32A 50A	N20 . x - x - x x . UR3 N33F . x - x - x x ²⁾ . UR3	
			88 □ 63A	N40 . x - x - x - . UR3	

Changeover switches with 1 latched and 1 momentary position UK

1-pole position 1 latched position 2 with spring return		60°+30°	1 48 □ 20A 32A	M10H . x x x x x ¹⁾ - . UK1 M20 . x x x x - - . UK1	
			64 □ 32A 50A	N20 . x - x - x x . UK1 N33F . x - x - x x ²⁾ . UK1	
			88 □ 63A	N40 . x - x - x - . UK1	
2-pole position 1 latched position 2 with spring return		60°+30°	2 48 □ 20A 32A	M10H . x x x x x ¹⁾ - . UK2 M20 . x x x x - - . UK2	
			64 □ 32A 50A	N20 . x - x - x x . UK2 N33F . x - x - x x ²⁾ . UK2	
			88 □ 63A	N40 . x - x - x - . UK2	
3-pole position 1 latched position 2 with spring return		60°+30°	3 48 □ 20A 32A	M10H . x x x x x ¹⁾ - . UK3 M20 . x x x x - - . UK3	
			64 □ 32A 50A	N20 . x - x - x x . UK3 N33F . x - x - x x ²⁾ . UK3	
			88 □ 63A	N40 . x - x - x - . UK3	

Ordering example: AC21 63A panel mounting, changeover switch, position 1 latched, position 2 with spring return, 3-pole: **N40 E UK3**

1) Plastic enclosed switches are delivered with switch type M10.

2) Cast enclosed switches are delivered with switch type N32.

Switching programs

DescriptiDescription	Wiring diagram	Switching angle	Number of cells ↓ Size ↓ AC21	Type	Design see page 6-8 E. Z. V. SMA. P. G.	Switch pro- gram	Escutcheon plate
Double throw switches with spring return to off WR							
1-pole		30°	1 48 □ 20A	M10H . x x x x x ¹⁾ - . W1R			
			32A	M20 . x x x x - - . W1R			
			64 □ 32A	N20 . x - x - x x . W1R			
50A	N33F . x - x - x x ²⁾ . W1R						
88 □ 63A	N40 . x - x - x - . W1R						
2-pole		30°	2 48 □ 20A	M10H . x x x x x ¹⁾ - . W2R			
			32A	M20 . x x x x - - . W2R			
			64 □ 32A	N20 . x - x - x x . W2R			
50A	N33F . x - x - x x ²⁾ . W2R						
88 □ 63A	N40 . x - x - x - . W2R						
3-pole		30°	3 48 □ 20A	M10H . x x x x x ¹⁾ - . W3R			
			32A	M20 . x x x x - - . W3R			
			64 □ 32A	N20 . x - x - x x . W3R			
50A	N33F . x - x - x x ²⁾ . W3R						
88 □ 63A	N40 . x - x - x - . W3R						

Start-Stop switches S

Start-switch, 1-pole		30°	1 48 □ 20A	M10H . x x x x x ¹⁾ - . SE			
			32A	M20 . x x x x - - . SE			
			64 □ 32A	N20 . x - x - x x . SE			
50A	N33F . x - x - x x ²⁾ . SE						
Start-switch, 2-pole		30°	1 48 □ 20A	M10H . x x x x x ¹⁾ - . S2E			
			32A	M20 . x x x x - - . S2E			
			64 □ 32A	N20 . x - x - x x . S2E			
50A	N33F . x - x - x x ²⁾ . S2E						
Start-switch, 3-pole		30°	2 48 □ 20A	M10H . x x x x x ¹⁾ - . S3E			
			32A	M20 . x x x x - - . S3E			
			64 □ 32A	N20 . x - x - x x . S3E			
50A	N33F . x - x - x x ²⁾ . S3E						

Bestellbeispiel: AC21 50A base mounting, Start-switch, 3-pole

N33F V S3E

1) Plastic enclosed switches are delivered with switch type M10.

2) Cast enclosed switches are delivered with switch type N32.

Switching programs

Description	Wiring diagram	Switching angle	Number of cells ↓ Size ↓ AC21	Type	Design see page 6-8 E. Z. V. SMA. P. G.	Switch pro- gram	Escutcheon plate
Stop-switch, 1-pole		30°	1 48 □ 20A	M10H . x x x x x ¹⁾ - . SA	M20 . x x x x - - . SA		
			64 □ 32A	N20 . x - x - x x . SA	N33F . x - x - x x ²⁾ . SA		
			88 □ 63A	N40 . x - x - x - . SA			
Stop-switch, 2-pole		30°	1 48 □ 20A	M10H . x x x x x ¹⁾ - . S2A	M20 . x x x x - - . S2A		
			64 □ 32A	N20 . x - x - x x . S2A	N33F . x - x - x x ²⁾ . S2A		
			88 □ 63A	N40 . x - x - x - . S2A			
Stop-switch, 3-pole		30°	2 48 □ 20A	M10H . x x x x x ¹⁾ - . S3A	M20 . x x x x - - . S3A		
			64 □ 32A	N20 . x - x - x x . S3A	N33F . x - x - x x ²⁾ . S3A		
			88 □ 63A	N40 . x - x - x - . S3A			
Start-Stop-switch, 1-pole		30°	1 48 □ 20A	M10H . x x x x x ¹⁾ - . SEA	M20 . x x x x - - . SEA		
			64 □ 32A	N20 . x - x - x x . SEA	N33F . x - x - x x ²⁾ . SEA		
Start-Stop-switch, 1-pole position START with spring return to 1		90°+30°	1 48 □ 20A	M10H . x x x x x ¹⁾ - . S392	M20 . x x x x - - . S392		
			64 □ 32A	N20 . x - x - x x . S392	N33F . x - x - x x ²⁾ . S392		
Start-Stop-switch, 1-pole for reversing contactors		60°+30°	2 48 □ 20A	M10H . x x x x x ¹⁾ - . S2EA	M20 . x x x x - - . S2EA		
			64 □ 32A	N20 . x - x - x x . S2EA	N33F . x - x - x x ²⁾ . S2EA		
Start-Stop-switch, 1-pole for reversing contactors with limit switches		30°	2 48 □ 20A	M10H . x x x x x ¹⁾ - . S22	M20 . x x x x - - . S22		
			64 □ 32A	N20 . x - x - x x . S22	N33F . x - x - x x ²⁾ . S22		

Ordering example: AC21 50A panel mounting, Start-Stop-switch, 1-pole for reversing contactors

N33F E S2EA



1) Plastic enclosed switches are delivered with switch type M10.

2) Cast enclosed switches are delivered with switch type N32.

Switching programs

Description	Wiring diagram	Switching angle	Number of cells ↓ Size ↓ AC21	Type	Design see page 6-8 E. Z. V. SMA. P. G.	Switch pro- gram	Escutcheon plate
-------------	----------------	-----------------	---	------	---	------------------------	---------------------

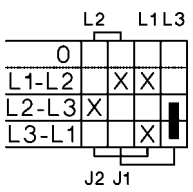
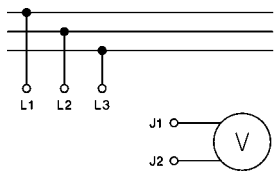
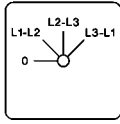
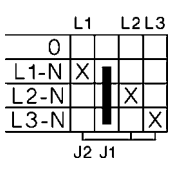
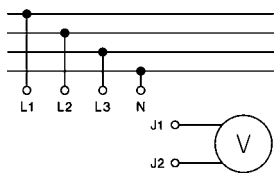
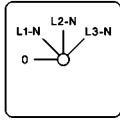
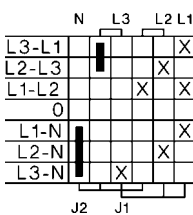
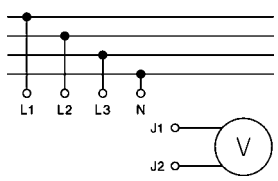
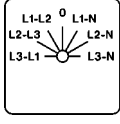
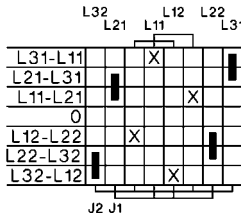
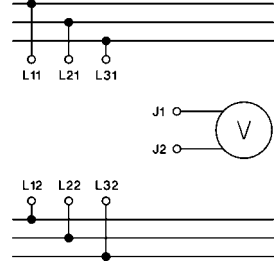
Voltmeter selector switches V

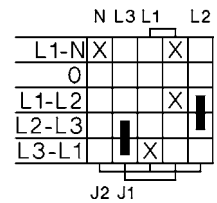
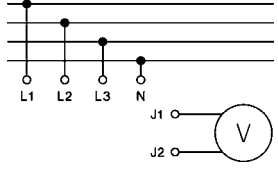
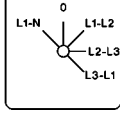
3 line voltages 		45°	2 48 □ 20A 32A 64 □ 32A 50A	M10H . x x x x x ¹⁾ - . V3 M20 . x x x x - - . V3 N20 . x - x - x x . V3 N33F . x x x - x x ²⁾ . V3		
3 phase voltages 		45°	2 48 □ 20A 32A 64 □ 32A 50A	M10H . x x x x x ¹⁾ - . V0 M20 . x x x x - - . V0 N20 . x - x - x x . V0 N33F . x x x - x x ²⁾ . V0		
3 line voltages and 3 phase voltages 		30°	3 48 □ 20A 32A 64 □ 32A 50A	M10H . x x x x x ¹⁾ - . V1 M20 . x x x x - - . V1 N20 . x - x - x x . V1 N33F . x x x - x x ²⁾ . V1		
2 3-phase systems 2 x 3 line voltages 		45°	4 48 □ 20A 32A 64 □ 32A 50A	M10H . x x x x x ¹⁾ - . V32 M20 . x x x x - - . V32 N20 . x - x - x x . V32 N33F . x - x - x x ²⁾ . V32		
3 line voltages and 1 phase voltage 		45°	3 48 □ 20A 32A 64 □ 32A 50A	M10H . x x x x x ¹⁾ - . V13 M20 . x x x x - - . V13 N20 . x - x - x x . V13 N33F . x x x - x x ²⁾ . V13		

Ordering example: AC21 50A panel mounting, Voltmeter selector switch, 3 line voltages and 1 phase voltage

N33F E V13

1) Plastic enclosed switches are delivered with switch type M10.

2) Cast enclosed switches are delivered with switch type N32.

Switching programs

Description	Wiring diagram	Switching angle	Number of cells ↓ Size ↓ AC21	Type	Design see page 6-8 E. Z. V. SMA. P. G.	Switch pro- gram	Escutcheon plate
-------------	----------------	-----------------	---	------	---	------------------------	---------------------

Ammeter selector switches M

1-pole, for current transformer 		90°	1	48 □ 20A 32A	M10H . x x x x x ¹⁾ - . M11 M20 . x x x x - - . M11	
			64 □ 32A 50A	N20 . x - x - x x . M11 N33F . x x x - x x ²⁾ . M11		
			88 □ 63A	N40 . x - x - x - . M11		
2-pole, for 1 current transformer or direct current measurement 		90°	2	48 □ 20A 32A	M10H . x x x x x ¹⁾ - . M12 M20 . x x x x - - . M12	
			64 □ 32A 50A	N20 . x - x - x x . M12 N33F . x x x - x x ²⁾ . M12		
			88 □ 63A 80A 115A	N40 . x - x - x - . M12 N60 . x - x - x - . M12 N80 . x - x - - - . M12		
			132 □ 150A 250A	N100 . x - x - - - . M12 N200 . x - x - - - . M12		
1-pole, for 2 current transformers 		90°	2	48 □ 20A 32A	M10H . x x x x x ¹⁾ - . M21 M20 . x x x x - - . M21	
			64 □ 32A 50A	N20 . x - x - x x . M21 N33F . x x x - x x ²⁾ . M21		
			88 □ 63A	N40 . x - x - x - . M21		
2-pole, for 2 current transformers or direct current measurement in 2 phases 		90°	3	48 □ 20A 32A	M10H . x x x x x ¹⁾ - . M22 M20 . x x x x - - . M22	
			64 □ 32A 50A	N20 . x - x - x x . M22 N33F . x x x - x x ²⁾ . M22		
			88 □ 63A 80A 115A	N40 . x - x - x - . M22 N60 . x - x - x - . M22 N80 . x - x - - - . M22		
			132 □ 150A 250A	N100 . x - x - - - . M22 N200 . x - x - - - . M22		
1-pole, for 3 current transformers 		90°	3	48 □ 20A 32A	M10H . x x x x x ¹⁾ - . M31 M20 . x x x x - - . M31	
			64 □ 32A 50A	N20 . x - x - x x . M31 N33F . x - x - x x ²⁾ . M31		
			88 □ 63A	N40 . x - x - x - . M31		

Ordering example: AC21 63A panel mounting, ammeter selector switch, for 3 current transformers 1-pole

N40 V M31

1) Plastic enclosed switches are delivered with switch type M10.

2) Cast enclosed switches are delivered with switch type N32.

Switching programs

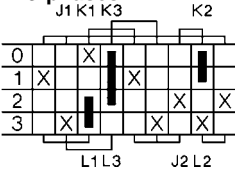
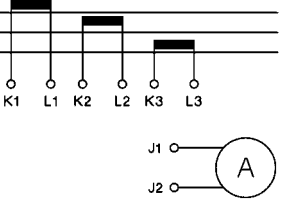
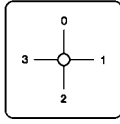
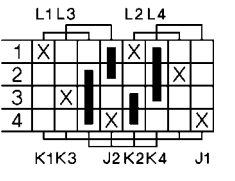
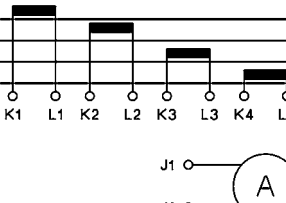
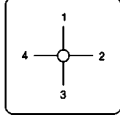
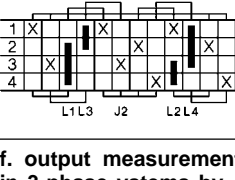
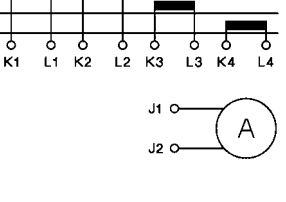
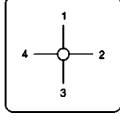
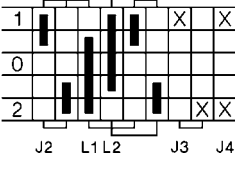
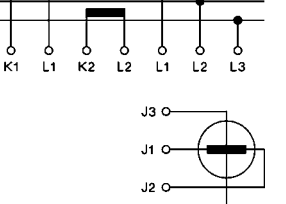
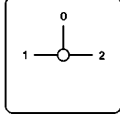
Description	Wiring diagram	Switching angle	Number of cells ↓ Size ↓ AC21	Type	Design see page 6-8 E. Z. V. SMA. P. G.	Switch pro- gram	Escutcheon plate
2-pole, for 3 current transformers or direct current measurement in 3 phases 		90°	6	48 □ 20A 32A 64 □ 32A 50A 88 □ 63A 80A 115A 132 □ 150A 250A	M10H . x x x x x ¹⁾ - . M32 M20 . x x x - - - . M32 N20 . x - x - x x . M32 N33F . x - x - x - . M32 N40 . x - x - x - . M32 N60 . x - x - x - . M32 N80 . x - x - - - . M32 N100 . x - x - - - . M32 N200 . x - x - - - . M32		
1-pole, for 4 current transformers 		90°	4	48 □ 20A 32A 64 □ 32A 50A 88 □ 63A	M10H . x x x x x ¹⁾ - . M41 M20 . x x x x - - . M41 N20 . x - x - x x . M41 N33F . x - x - x x ²⁾ . M41 N40 . x - x - x - . M41		
2-pole, for 4 current transformers or direct current measurement in 4 phases 		90°	6	48 □ 20A 32A 64 □ 32A 50A 88 □ 63A 80A 115A 132 □ 150A 250A	M10H . x x x x x ¹⁾ - . M42 M20 . x x x - - - . M42 N20 . x - x - x x . M42 N33F . x - x - x - . M42 N40 . x - x - x - . M42 N60 . x - x - x - . M42 N80 . x - x - - - . M42 N100 . x - x - - - . M42 N200 . x - x - - - . M42		
f. output measurement in 3-phase systems by 2-wattmeter method 		90°	5	48 □ 20A 32A 64 □ 32A 50A 88 □ 63A 80A 115A 132 □ 150A 250A	M10H . x x x x x ¹⁾ - . M2W M20 . x x x x - - . M2W N20 . x - x - x x . M2W N33F . x - x - x x ²⁾ . M2W N40 . x - x - x - . M2W N60 . x - x - x - . M2W N80 . x - x - - - . M2W N100 . x - x - - - . M2W N200 . x - x - - - . M2W		

Ordering example: AC21 63A panel mounting, ammeter selector switch, for 4 current transformers 1-pole

N40 V M41

1) Plastic enclosed switches are delivered with switch type M10.

2) Cast enclosed switches are delivered with switch type N32.

Switching programs

Description	Wiring diagram	Switching angle	Number of cells ↓ Size ↓ AC21	Type	Design see page 6-8 E. Z. V. SMA. P. G.	Switch pro- gram	Escutcheon plate
2 circuits A and B 1-pole 0 - A - A+B		45°	1 48 □ 20A 32A 64 □ 32A 50A 88 □ 63A 80A 115A 132 □ 150A 250A	M10H . x x x x x ¹⁾ - . GR11 M20 . x x x x - - . GR11 N20 . x - x - x x . GR11 N33F . x x x - x x ²⁾ . GR11 N40 . x - x - x - . GR11 N60 . x - x - x - . GR11 N80 . x - x - - - . GR11 N100 . x - x - - - . GR11 N200 . x - x - - - . GR11		+126	
2 circuits A and B 1-pole 0 - A - B - A+B		45°	1 48 □ 20A 32A 64 □ 32A 50A 88 □ 63A 80A 115A 132 □ 150A 250A	M10H . x x x x x ¹⁾ - . GR12 M20 . x x x x - - . GR12 N20 . x - x - x x . GR12 N33F . x x x - x x ²⁾ . GR12 N40 . x - x - x - . GR12 N60 . x - x - x - . GR12 N80 . x - x - - - . GR12 N100 . x - x - - - . GR12 N200 . x - x - - - . GR12		+127	
2 circuits A and B 2-pole 0 - A - A+B		45°	2 48 □ 20A 32A 64 □ 32A 50A 88 □ 63A 80A 115A 132 □ 150A 250A	M10H . x x x x x ¹⁾ - . GR21 M20 . x x x x - - . GR21 N20 . x - x - x x . GR21 N33F . x x x - x x ²⁾ . GR21 N40 . x - x - x - . GR21 N60 . x - x - x - . GR21 N80 . x - x - - - . GR21 N100 . x - x - - - . GR21 N200 . x - x - - - . GR21		+126	
2 circuits A and B 2-pole 0 - A - B - A+B		45°	2 48 □ 20A 32A 64 □ 32A 50A 88 □ 63A 80A 115A 132 □ 150A 250A	M10H . x x x x x ¹⁾ - . GR22 M20 . x x x x - - . GR22 N20 . x - x - x x . GR22 N33F . x x x - x x ²⁾ . GR22 N40 . x - x - x - . GR22 N60 . x - x - x - . GR22 N80 . x - x - - - . GR22 N100 . x - x - - - . GR22 N200 . x - x - - - . GR22		+127	
2 circuits A and B 3-pole 0 - A - A+B		45°	3 48 □ 20A 32A 64 □ 32A 50A 88 □ 63A 80A 115A 132 □ 150A 250A	M10H . x x x x x ¹⁾ - . GR31 M20 . x x x x - - . GR31 N20 . x - x - x x . GR31 N33F . x - x - x x ²⁾ . GR31 N40 . x - x - x x . GR31 N60 . x - x - x - . GR31 N80 . x - x - - - . GR31 N100 . x - x - - - . GR31 N200 . x - x - - - . GR31		+126	

Ordering example: AC21 250A panel mounting, gang switch, 2 circuits A and B, 3-pole

N200 E GR31

1) Plastic enclosed switches are delivered with switch type M10.

2) Cast enclosed switches are delivered with switch type N32.

Switching programs

DescriptiDescription	Wiring diagram	Switching angle	Number of cells ↓ Size ↓ AC21	Type	Design see page 6-8 E. Z. V. SMA. P. G.	Switch pro- gram	Escutcheon plate
2 circuits A and B 3-pole 0 - A - B - A+B 		45°	3 48 □ 20A 32A 64 □ 32A 50A 88 □ 63A 80A 115A 132 □ 150A 250A	M10H . x x x x x ¹⁾ - . GR32 M20 . x x x x - - . GR32 N20 . x - x - x x . GR32 N33F . x - x - x x ²⁾ . GR32 N40 . x - x - x - . GR32 N60 . x - x - x - . GR32 N80 . x - x - - - . GR32 N100 . x - x - - - . GR32 N200 . x - x - - - . GR32			
3 circuits A, B and C 1-pole 0 - A - A+B - A+B+C 		45°	2 48 □ 20A 32A 64 □ 32A 50A 88 □ 63A 80A 115A 132 □ 150A 250A	M10H . x x x x x ¹⁾ - . GR14 M20 . x x x x - - . GR14 N20 . x - x - x x . GR14 N33F . x - x - x x ²⁾ . GR14 N40 . x - x - x - . GR14 N60 . x - x - x - . GR14 N80 . x - x - - - . GR14 N100 . x - x - - - . GR14 N200 . x - x - - - . GR14			
3 circuits A, B and C 2-pole 0 - A - A+B - A+B+C 		45°	3 48 □ 20A 32A 64 □ 32A 50A 88 □ 63A 80A 115A 132 □ 150A 250A	M10H . x x x x x ¹⁾ - . GR23 M20 . x x x x - - . GR23 N20 . x - x - x x . GR23 N33F . x - x - x x ²⁾ . GR23 N40 . x - x - x - . GR23 N60 . x - x - x - . GR23 N80 . x - x - - - . GR23 N100 . x - x - - - . GR23 N200 . x - x - - - . GR23			
3 circuits A, B and C 3-pole 0 - A - A+B - A+B+C 		45°	5 48 □ 20A 32A 64 □ 32A 50A 88 □ 63A 80A 115A 132 □ 150A 250A	M10H . x x x x x ¹⁾ - . GR33 M20 . x x x x - - . GR33 N20 . x - x - x x . GR33 N33F . x - x - x x ²⁾ . GR33 N40 . x - x - x - . GR33 N60 . x - x - x - . GR33 N80 . x - x - - - . GR33 N100 . x - x - - - . GR33 N200 . x - x - - - . GR33			

Ordering example: AC21 250A panel mounting, gang switch, 3 circuits A, B and C, 3-pole **N200 E GR33**

1) Plastic enclosed switches are delivered with switch type M10.

2) Cast enclosed switches are delivered with switch type N32.

Switching programs

Description Schaltbild	Wiring diagram	Switching angle	Number of cells ↓ Size ↓ AC21	Type	Design see page 6-8 E. Z. V. SMA. P. G.	Switch pro- gram	Escutcheon plate
Series-Parallel switches SP							
2 circuits A and B 2-pole 0 - A + B - A,B (parallel)		45°	2	48 □ 20A	M10H . x x x x x ¹⁾ - . SP1	. SP1	
				32A	M20 . x x x x - - . SP1		
				64 □ 32A	N20 . x - x - x x . SP1		
				50A	N33F . x x x - x x ²⁾ . SP1		
88 □ 63A	N40 . x - x - x - . SP1	. SP1					
80A	N60 . x - x - x - . SP1						
115A	N80 . x - x - - - . SP1						
132 □ 150A	N100 . x - x - - - . SP1	. SP1					
250A	N200 . x - x - - - . SP1						
+126							
2 circuits A and B 2-pole 0 - A,B (parall.) - A - A+B		90°	3	48 □ 20A	M10H . x x x x x ¹⁾ - . SP4	. SP4	
				32A	M20 . x x x x - - . SP4		
				64 □ 32A	N20 . x - x - x x . SP4		
				50A	N33F . x x x - x x ²⁾ . SP4		
88 □ 63A	N40 . x - x - x - . SP4	. SP4					
80A	N60 . x - x - x - . SP4						
115A	N80 . x - x - - - . SP4						
132 □ 150A	N100 . x - x - - - . SP4	. SP4					
250A	N200 . x - x - - - . SP4						
+270							
2 circuits A and B for 3-phase systems 0 - A+B - A - B - A,B		30°	2	48 □ 20A	M10H . x x x x x ¹⁾ - . SP3	. SP3	
				32A	M20 . x x x x - - . SP3		
				64 □ 32A	N20 . x - x - x x . SP3		
				50A	N33F . x x x - x x ²⁾ . SP3		
88 □ 63A	N40 . x - x - x - . SP3	. SP3					
80A	N60 . x - x - x - . SP3						
115A	N80 . x - x - - - . SP3						
132 □ 150A	N100 . x - x - - - . SP3	. SP3					
250A	N200 . x - x - - - . SP3						
+112							

Ordering example: AC21 250A panel mounting, series-parallel switch, 2 circuits for 3-phase systems

N200 E SP3

1) Plastic enclosed switches are delivered with switch type M10.

2) Cast enclosed switches are delivered with switch type N32.

Switching programs

Description	Wiring diagram	Switching angle	Number of cells ↓ Size ↓ AC21	Type	Design see page 6-8 E. Z. V. SMA. P. G.	Switch pro- gram	Escutcheon plate
Multi step switches 1-pole without Off ST.1							
3 steps		60°	2	48 □ 20A 32A	M10H . x x x x x ¹⁾ - . ST31 M20 . x x x x - - . ST31		
			64 □ 32A 50A	N20 . x - x - x x . ST31 N33F . x x x - x x ²⁾ . ST31			
			88 □ 63A 80A 115A	N40 . x - x - x - . ST31 N60 . x - x - x - . ST31 N80 . x - x - - - . ST31			
			132 □ 150A 250A	N100 . x - x - - - . ST31 N200 . x - x - - - . ST31			
4 steps		60°	2	48 □ 20A 32A	M10H . x x x x x ¹⁾ - . ST41 M20 . x x x x - - . ST41		
			64 □ 32A 50A	N20 . x - x - x x . ST41 N33F . x x x - x x ²⁾ . ST41			
			88 □ 63A 80A 115A	N40 . x - x - x - . ST41 N60 . x - x - x - . ST41 N80 . x - x - - - . ST41			
			132 □ 150A 250A	N100 . x - x - - - . ST41 N200 . x - x - - - . ST41			
5 steps		60°	3	48 □ 20A 32A	M10H . x x x x x ¹⁾ - . ST51 M20 . x x x x - - . ST51		
			64 □ 32A 50A	N20 . x - x - x x . ST51 N33F . x x x - x x ²⁾ . ST51			
			88 □ 63A 80A 115A	N40 . x - x - x - . ST51 N60 . x - x - x - . ST51 N80 . x - x - - - . ST51			
			132 □ 150A 250A	N100 . x - x - - - . ST51 N200 . x - x - - - . ST51			
6 steps		60°	3	48 □ 20A 32A	M10H . x x x x x ¹⁾ - . ST61 M20 . x x x x - - . ST61		
			64 □ 32A 50A	N20 . x - x - x x . ST61 N33F . x x x - x x ²⁾ . ST61			
			88 □ 63A 80A 115A	N40 . x - x - x - . ST61 N60 . x - x - x - . ST61 N80 . x - x - - - . ST61			
			132 □ 150A 250A	N100 . x - x - - - . ST61 N200 . x - x - - - . ST61			
7 steps		45°	4	48 □ 20A 32A	M10H . x x x x x ¹⁾ - . ST71 M20 . x x x x - - . ST71		
			64 □ 32A 50A	N20 . x - x - x x . ST71 N33F . x - x - x x ²⁾ . ST71			
			88 □ 63A 80A 115A	N40 . x - x - x - . ST71 N60 . x - x - x - . ST71 N80 . x - x - - - . ST71			
			132 □ 150A 250A	N100 . x - x - - - . ST71 N200 . x - x - - - . ST71			

Ordering example: AC21 250A panel mounting, multi step switch 1-pole without off, 7 steps **N200 E ST71**

1) Plastic enclosed switches are delivered with switch type M10.

2) Cast enclosed switches are delivered with switch type N32.

Switching programs

Description	Wiring diagram	Switching angle	Number of cells ↓ Size ↓ AC21	Type	Design see page 6-8 E. Z. V. SMA. P. G.	Switch pro- gram	Escutcheon plate
Multi step switches 1-pole without Off ST.1							
8 steps		45°	4	48 □ 20A 32A	M10H . x x x x x ¹⁾ - . ST81 M20 . x x x x - - . ST81		
			64 □	32A 50A	N20 . x - x - x x . ST81 N33F . x - x - x x ²⁾ . ST81		
			88 □	63A 80A 115A	N40 . x - x - x - . ST81 N60 . x - x - x - . ST81 N80 . x - x - - - . ST81		
			132 □	150A 250A	N100 . x - x - - - . ST81 N200 . x - x - - - . ST81		
			9 steps	30°	5		
64 □	32A 50A	N20 . x - x - x x . ST91 N33F . x - x - x x ²⁾ . ST91					
88 □	63A 80A 115A	N40 . x - x - x - . ST91 N60 . x - x - x - . ST91 N80 . x - x - - - . ST91					
132 □	150A 250A	N100 . x - x - - - . ST91 N200 . x - x - - - . ST91					
10 steps	30°	5	48 □ 20A 32A	M10H . x x x x x ¹⁾ - . ST101 M20 . x x x x - - . ST101			
64 □	32A 50A	N20 . x - x - x x . ST101 N33F . x - x - x x ²⁾ . ST101					
88 □	63A 80A 115A	N40 . x - x - x - . ST101 N60 . x - x - x - . ST101 N80 . x - x - - - . ST101					
132 □	150A 250A	N100 . x - x - - - . ST101 N200 . x - x - - - . ST101					
11 steps	30°	6	48 □ 20A 32A	M10H . x x x - x ¹⁾ - . ST111 M20 . x x x - - - . ST111			
64 □	32A 50A	N20 . x - x - x x . ST111 N33F . x - x - x - . ST111					
88 □	63A 80A 115A	N40 . x - x - x - . ST111 N60 . x - x - x - . ST111 N80 . x - x - - - . ST111					
132 □	150A 250A	N100 . x - x - - - . ST111 N200 . x - x - - - . ST111					
12 steps	30°	6	48 □ 20A 32A	M10H . x x x - x ¹⁾ - . ST121 M20 . x x x - - - . ST121			
64 □	32A 50A	N20 . x - x - x x . ST121 N33F . x - x - x - . ST121					
88 □	63A 80A 115A	N40 . x - x - x - . ST121 N60 . x - x - x - . ST121 N80 . x - x - - - . ST121					
132 □	150A 250A	N100 . x - x - - - . ST121 N200 . x - x - - - . ST121					

Ordering example: AC21 250A panel mounting, multi step switch 1-pole without off, 12 steps

N200 E ST121

1) Plastic enclosed switches are delivered with switch type M10.

2) Cast enclosed switches are delivered with switch type N32.

Switching programs

Description	Wiring diagram	Switching angle	Number of cells ↓ Size ↓ AC21	Type	Design see page 6-8 E. Z. V. SMA. P. G.	Switch pro- gram	Escutcheon plate
Multi step switches 1-pole with Off ST0.1							
2 steps		60°	1 48 □ 20A	M10H . x x x x x ¹⁾ - . ST021			
			32A	M20 . x x x x - - . ST021			
			64 □ 32A	N20 . x - x - x x . ST021			
			50A	N33F . x x x - x x ²⁾ . ST021			
			88 □ 63A	N40 . x - x - x - . ST021			
80A	N60 . x - x - x - . ST021						
115A	N80 . x - x - - - . ST021						
132 □ 150A	N100 . x - x - - - . ST021						
250A	N200 . x - x - - - . ST021						
3 steps		45°	2 48 □ 20A	M10H . x x x x x ¹⁾ - . ST031			
			32A	M20 . x x x x - - . ST031			
			64 □ 32A	N20 . x - x - x x . ST031			
			50A	N33F . x x x - x x ²⁾ . ST031			
			88 □ 63A	N40 . x - x - x - . ST031			
80A	N60 . x - x - x - . ST031						
115A	N80 . x - x - - - . ST031						
132 □ 150A	N100 . x - x - - - . ST031						
250A	N200 . x - x - - - . ST031						
4 steps		30°	2 48 □ 20A	M10H . x x x x x ¹⁾ - . ST041			
			32A	M20 . x x x x - - . ST041			
			64 □ 32A	N20 . x - x - x x . ST041			
			50A	N33F . x x x - x x ²⁾ . ST041			
			88 □ 63A	N40 . x - x - x - . ST041			
80A	N60 . x - x - x - . ST041						
115A	N80 . x - x - - - . ST041						
132 □ 150A	N100 . x - x - - - . ST041						
250A	N200 . x - x - - - . ST041						
5 steps		45°	3 48 □ 20A	M10H . x x x x x ¹⁾ - . ST051			
			32A	M20 . x x x x - - . ST051			
			64 □ 32A	N20 . x - x - x x . ST051			
			50A	N33F . x x x - x x ²⁾ . ST051			
			88 □ 63A	N40 . x - x - x - . ST051			
80A	N60 . x - x - x - . ST051						
115A	N80 . x - x - - - . ST051						
132 □ 150A	N100 . x - x - - - . ST051						
250A	N200 . x - x - - - . ST051						
6 steps		45°	4 48 □ 20A	M10H . x x x x x ¹⁾ - . ST061			
			32A	M20 . x x x x - - . ST061			
			64 □ 32A	N20 . x - x - x x . ST061			
			50A	N33F . x - x - x x ²⁾ . ST061			
			88 □ 63A	N40 . x - x - x - . ST061			
80A	N60 . x - x - x - . ST061						
115A	N80 . x - x - - - . ST061						
132 □ 150A	N100 . x - x - - - . ST061						
250A	N200 . x - x - - - . ST061						

Ordering example: AC21 250A panel mounting, multi step switch 1-pole with off, 6 steps

N200 E ST061

1) Plastic enclosed switches are delivered with switch type M10.

2) Cast enclosed switches are delivered with switch type N32.

Switching programs

Description	Wiring diagram	Switching angle	Number of cells ↓ Size ↓ AC21	Type	Design see page 6-8 E. Z. V. SMA. P. G.	Switch pro- gram	Escutcheon plate
Multi step switches 1-pole with Off ST0.1							
7 steps		45°	4	48 □ 20A 32A	M10H . x x x x x ¹⁾ - . ST071 M20 . x x x x - - . ST071		
			64 □ 32A 50A	N20 . x - x - - x x . ST071 N33F . x - x - - x x ²⁾ . ST071			
			88 □ 63A 80A 115A	N40 . x - x - - x - . ST071 N60 . x - x - - x - . ST071 N80 . x - x - - - - . ST071			
			132 □ 150A 250A	N100 . x - x - - - - . ST071 N200 . x - x - - - - . ST071			
8 steps		30°	5	48 □ 20A 32A	M10H . x x x x x ¹⁾ - . ST081 M20 . x x x x - - . ST081		
			64 □ 32A 50A	N20 . x - x - - x x . ST081 N33F . x - x - - x x ²⁾ . ST081			
			88 □ 63A 80A 115A	N40 . x - x - - x - . ST081 N60 . x - x - - x - . ST081 N80 . x - x - - - - . ST081			
			132 □ 150A 250A	N100 . x - x - - - - . ST081 N200 . x - x - - - - . ST081			
9 steps		30°	5	48 □ 20A 32A	M10H . x x x x x ¹⁾ - . ST091 M20 . x x x x - - . ST091		
			64 □ 32A 50A	N20 . x - x - - x x . ST091 N33F . x - x - - x x ²⁾ . ST091			
			88 □ 63A 80A 115A	N40 . x - x - - x - . ST091 N60 . x - x - - x - . ST091 N80 . x - x - - - - . ST091			
			132 □ 150A 250A	N100 . x - x - - - - . ST091 N200 . x - x - - - - . ST091			
10 steps		30°	6	48 □ 20A 32A	M10H . x x x - - x ¹⁾ - . ST0101 M20 . x x x - - - - . ST0101		
			64 □ 32A 50A	N20 . x - x - - x x . ST0101 N33F . x - x - - x - . ST0101			
			88 □ 63A 80A 115A	N40 . x - x - - x - . ST0101 N60 . x - x - - x - . ST0101 N80 . x - x - - - - . ST0101			
			132 □ 150A 250A	N100 . x - x - - - - . ST0101 N200 . x - x - - - - . ST0101			
11 steps		30°	6	48 □ 20A 32A	M10H . x x x - - x ¹⁾ - . ST0111 M20 . x x x - - - - . ST0111		
			64 □ 32A 50A	N20 . x - x - - x x . ST0111 N33F . x - x - - x - . ST0111			
			88 □ 63A 80A 115A	N40 . x - x - - x - . ST0111 N60 . x - x - - x - . ST0111 N80 . x - x - - - - . ST0111			
			132 □ 150A 250A	N100 . x - x - - - - . ST0111 N200 . x - x - - - - . ST0111			

Ordering example: AC21 250A panel mounting, multi step switch 1-pole with off, 11 steps **N200 E ST0111**

1) Plastic enclosed switches are delivered with switch type M10.

2) Cast enclosed switches are delivered with switch type N32.

Switching programs

Description	Wiring diagram	Switching angle	Number of cells ↓ Size ↓ AC21	Type	Design see page 6-8 E. Z. V. SMA. P. G.	Switch pro- gram	Escutcheon plate
Multi step switches 2-pole without Off ST.2							
3 steps		60°	3	48 □ 20A 32A	M10H . x x x x x ¹⁾ - . ST32 M20 . x x x x - - . ST32		
				64 □ 32A 50A	N20 . x - x - x x . ST32 N33F . x x x - x x ²⁾ . ST32		
				88 □ 63A 80A 115A	N40 . x - x - x - . ST32 N60 . x - x - x - . ST32 N80 . x - x - - - . ST32		
				132 □ 150A 250A	N100 . x - x - - - . ST32 N200 . x - x - - - . ST32		
4 steps		60°	4	48 □ 20A 32A	M10H . x x x x x ¹⁾ - . ST42 M20 . x x x x - - . ST42		
				64 □ 32A 50A	N20 . x - x - x x . ST42 N33F . x - x - x x ²⁾ . ST42		
				88 □ 63A 80A 115A	N40 . x - x - x - . ST42 N60 . x - x - x - . ST42 N80 . x - x - - - . ST42		
				132 □ 150A 250A	N100 . x - x - - - . ST42 N200 . x - x - - - . ST42		
5 steps		60°	5	48 □ 20A 32A	M10H . x x x x x ¹⁾ - . ST52 M20 . x x x x - - . ST52		
				64 □ 32A 50A	N20 . x - x - x x . ST52 N33F . x - x - x x ²⁾ . ST52		
				88 □ 63A 80A 115A	N40 . x - x - x - . ST52 N60 . x - x - x - . ST52 N80 . x - x - - - . ST52		
				132 □ 150A 250A	N100 . x - x - - - . ST52 N200 . x - x - - - . ST52		
6 steps		60°	6	48 □ 20A 32A	M10H . x x x - x ¹⁾ - . ST62 M20 . x x x - - - . ST62		
				64 □ 32A 50A	N20 . x - x - x x . ST62 N33F . x - x - x - . ST62		
				88 □ 63A 80A 115A	N40 . x - x - x - . ST62 N60 . x - x - x - . ST62 N80 . x - x - - - . ST62		
				132 □ 150A 250A	N100 . x - x - - - . ST62 N200 . x - x - - - . ST62		
7 steps		45°	7	48 □ 20A 32A	M10H . x x x - - - . ST72 M20 . x x x - - - . ST72		
				64 □ 32A 50A	N20 . x - x - x - . ST72 N33F . x - x - - - . ST72		
				88 □ 63A 80A 115A	N40 . x - x - x - . ST72 N60 . x - x - - - . ST72 N80 . x - x - - - . ST72		
				132 □ 150A 250A	N100 . x - x - - - . ST72 N200 . x - x - - - . ST72		

Ordering example: AC21 250A panel mounting, multi step switch 2-pole without off, 7 steps **N200 E ST72**

1) Plastic enclosed switches are delivered with switch type M10.

2) Cast enclosed switches are delivered with switch type N32.

Switching programs

Description	Wiring diagram	Switching angle	Number of cells ↓ Size ↓ AC21	Type	Design see page 6-8 E. Z. V. SMA. P. G.	Switch pro- gram	Escutcheon plate
Multi step switches 2-pole without Off ST.2							
8 steps		45°	8 48 □ 20A	M10H . x x x - - - . ST82			
			32A	M20 . x x x - - - . ST82			
			64 □ 32A	N20 . x - x - x - . ST82			
			50A	N33F . x - x - - - . ST82			
			88 □ 63A	N40 . x - x - x - . ST82			
80A	N60 . x - x - - - . ST82						
115A	N80 . x - x - - - . ST82						
132 □ 150A	N100 . x - x - - - . ST82						
250A	N200 . x - x - - - . ST82						
9 steps		30°	9 48 □ 20A	M10H . x x x - - - . ST92			
			32A	M20 . x x x - - - . ST92			
			64 □ 32A	N20 . x - x - - - . ST92			
			50A	N33F . x - x - - - . ST92			
			88 □ 63A	N40 . x - x - - - . ST92			
80A	N60 . x - x - - - . ST92						
115A	N80 . x - x - - - . ST92						
132 □ 150A	N100 . x - x - - - . ST92						
250A	N200 . x - x - - - . ST92						
10 steps		30°	10 48 □ 20A	M10H . x x x - - - . ST102			
			32A	M20 . x x x - - - . ST102			
			64 □ 32A	N20 . x - x - - - . ST102			
			50A	N33F . x - x - - - . ST102			
			88 □ 63A	N40 . x - x - - - . ST102			
80A	N60 . x - x - - - . ST102						
115A	N80 . x - x - - - . ST102						
132 □ 150A	N100 . x - x - - - . ST102						
250A	N200 . x - x - - - . ST102						
11 steps		30°	11 48 □ 20A	M10H . x x x - - - . ST112			
			32A	M20 . x x x - - - . ST112			
			64 □ 32A	N20 . x - x - - - . ST112			
			50A	N33F . x - x - - - . ST112			
			88 □ 63A	N40 . x - x - - - . ST112			
80A	N60 . x - x - - - . ST112						
115A	N80 . x - x - - - . ST112						
132 □ 150A	N100 . x - x - - - . ST112						
250A	N200 . x - x - - - . ST112						
12 steps		30°	12 48 □ 20A	M10H . x x x - - - . ST122			
			32A	M20 . x x x - - - . ST122			
			64 □ 32A	N20 . x - x - - - . ST122			
			50A	N33F . x - x - - - . ST122			
			88 □ 63A	N40 . x - x - - - . ST122			
80A	N60 . x - x - - - . ST122						
115A	N80 . x - x - - - . ST122						
132 □ 150A	N100 . x - x - - - . ST122						
250A	N200 . x - x - - - . ST122						

Ordering example: AC21 250A panel mounting, multi step switch 2-pole without off, 12 steps

N200 E ST122

Switching programs

Description	Wiring diagram	Switching angle	Number of cells ↓ Size ↓ AC21	Type	Design see page 6-8 E. Z. V. SMA. P. G.	Switch pro- gram	Escutcheon plate
Multi step switches 2-pole with Off ST0.2							
2 steps		60°	2	48 □ 20A	M10H . x x x x x ¹⁾ - . ST022		
				32A	M20 . x x x x - - . ST022		
				64 □ 32A	N20 . x - x - x x . ST022		
				50A	N33F . x x x - x x ²⁾ . ST022		
				88 □ 63A	N40 . x - x - x - . ST022		
80A	N60 . x - x - x - . ST022						
115A	N80 . x - x - - - . ST022						
132 □ 150A	N100 . x - x - - - . ST022						
250A	N200 . x - x - - - . ST022						
3 steps		45°	3	48 □ 20A	M10H . x x x x x ¹⁾ - . ST032		
				32A	M20 . x x x x - - . ST032		
				64 □ 32A	N20 . x - x - x x . ST032		
				50A	N33F . x x x - x x ²⁾ . ST032		
				88 □ 63A	N40 . x - x - x - . ST032		
80A	N60 . x - x - x - . ST032						
115A	N80 . x - x - - - . ST032						
132 □ 150A	N100 . x - x - - - . ST032						
250A	N200 . x - x - - - . ST032						
4 steps		30°	4	48 □ 20A	M10H . x x x x x ¹⁾ - . ST042		
				32A	M20 . x x x x - - . ST042		
				64 □ 32A	N20 . x - x - x x . ST042		
				50A	N33F . x - x - x x ²⁾ . ST042		
				88 □ 63A	N40 . x - x - x - . ST042		
80A	N60 . x - x - x - . ST042						
115A	N80 . x - x - - - . ST042						
132 □ 150A	N100 . x - x - - - . ST042						
250A	N200 . x - x - - - . ST042						
5 steps		45°	6	48 □ 20A	M10H . x x x - x ¹⁾ - . ST052		
				32A	M20 . x x x - - - . ST052		
				64 □ 32A	N20 . x - x - x x . ST052		
				50A	N33F . x - x - x - . ST052		
				88 □ 63A	N40 . x - x - x - . ST052		
80A	N60 . x - x - x - . ST052						
115A	N80 . x - x - - - . ST052						
132 □ 150A	N100 . x - x - - - . ST052						
250A	N200 . x - x - - - . ST052						
6 steps		45°	7	48 □ 20A	M10H . x x x - x ¹⁾ - . ST062		
				32A	M20 . x x x - - - . ST062		
				64 □ 32A	N20 . x - x - x - . ST062		
				50A	N33F . x - x - - - . ST062		
				88 □ 63A	N40 . x - x - x - . ST062		
80A	N60 . x - x - - - . ST062						
115A	N80 . x - x - - - . ST062						
132 □ 150A	N100 . x - x - - - . ST062						
250A	N200 . x - x - - - . ST062						

Ordering example: AC21 250A panel mounting, multi step switch 2-pole with off, 6 steps

N200 E ST062

1) Plastic enclosed switches are delivered with switch type M10.

2) Cast enclosed switches are delivered with switch type N32.

Switching programs

Description	Wiring diagram	Switching angle	Number of cells ↓ Size ↓ AC21	Type	Design see page 6-8 E. Z. V. SMA. P. G.	Switch program	Escutcheon plate
Multi step switches 2-pole with Off ST0.2							
7 steps		45°	8	48 □ 20A 32A	M10H . x x x - - - M20 . x x x - - -	. ST072 . ST072	
			64	32A 50A	N20 . x - x - x - N33F . x - x - - -	. ST072 . ST072	
			88	63A 80A 115A	N40 . x - x - x - N60 . x - x - - - N80 . x - x - - -	. ST072 . ST072 . ST072	
			132	150A 250A	N100 . x - x - - - N200 . x - x - - -	. ST072 . ST072	
8 steps		30°	9	48 □ 20A 32A	M10H . x x x - - - M20 . x x x - - -	. ST082 . ST082	
			64	32A 50A	N20 . x - x - - - N33F . x - x - - -	. ST082 . ST082	
			88	63A 80A 115A	N40 . x - x - - - N60 . x - x - - - N80 . x - x - - -	. ST082 . ST082 . ST082	
			132	150A 250A	N100 . x - x - - - N200 . x - x - - -	. ST082 . ST082	
9 steps		30°	10	48 □ 20A 32A	M10H . x x x - - - M20 . x x x - - -	. ST092 . ST092	
			64	32A 50A	N20 . x - x - - - N33F . x - x - - -	. ST092 . ST092	
			88	63A 80A 115A	N40 . x - x - - - N60 . x - x - - - N80 . x - x - - -	. ST092 . ST092 . ST092	
			132	150A 250A	N100 . x - x - - - N200 . x - x - - -	. ST092 . ST092	
10 steps		30°	11	48 □ 20A 32A	M10H . x x x - - - M20 . x x x - - -	. ST0102 . ST0102	
			64	32A 50A	N20 . x - x - - - N33F . x - x - - -	. ST0102 . ST0102	
			88	63A 80A 115A	N40 . x - x - - - N60 . x - x - - - N80 . x - x - - -	. ST0102 . ST0102 . ST0102	
			132	150A 250A	N100 . x - x - - - N200 . x - x - - -	. ST0102 . ST0102	
11 steps		30°	12	48 □ 20A 32A	M10H . x x x - - - M20 . x x x - - -	. ST0112 . ST0112	
			64	32A 50A	N20 . x - x - - - N33F . x - x - - -	. ST0112 . ST0112	
			88	63A 80A 115A	N40 . x - x - - - N60 . x - x - - - N80 . x - x - - -	. ST0112 . ST0112 . ST0112	
			132	150A 250A	N100 . x - x - - - N200 . x - x - - -	. ST0112 . ST0112	

Ordering example: AC21 250A panel mounting, multi step switch 2-pole with off, 11 steps N200 E ST0112

Switching programs

Description	Wiring diagram	Switching angle	Number of cells ↓ Size ↓ AC21	Type	Design see page 6-8 E. Z. V. SMA. P. G.	Switch pro- gram	Escutcheon plate
Multi step switches 3-pole without Off ST.3							
3 steps		60°	5	48 □ 20A 32A	M10H . x x x x x ¹⁾ - . ST33 M20 . x x x x - - . ST33		
			64 □ 32A 50A	N20 . x - x - x x . ST33 N33F . x - x - x x ²⁾ . ST33			
			88 □ 63A 80A 115A	N40 . x - x - x - . ST33 N60 . x - x - x - . ST33 N80 . x - x - - - . ST33			
			132 □ 150A 250A	N100 . x - x - - - . ST33 N200 . x - x - - - . ST33			
			4 steps		60°		6
64 □ 32A 50A	N20 . x - x - x x . ST43 N33F . x - x - x - . ST43						
88 □ 63A 80A 115A	N40 . x - x - x - . ST43 N60 . x - x - x - . ST43 N80 . x - x - - - . ST43						
132 □ 150A 250A	N100 . x - x - - - . ST43 N200 . x - x - - - . ST43						
5 steps		60°	8			48 □ 20A 32A	M10H . x x x - - - . ST53 M20 . x x x - - - . ST53
64 □ 32A 50A			N20 . x - x - x - . ST53 N33F . x - x - - - . ST53				
88 □ 63A 80A 115A			N40 . x - x - x - . ST53 N60 . x - x - - - . ST53 N80 . x - x - - - . ST53				
132 □ 150A 250A			N100 . x - x - - - . ST53 N200 . x - x - - - . ST53				
6 steps				60°	9	48 □ 20A 32A	M10H . x x x - - - . ST63 M20 . x x x - - - . ST63
64 □ 32A 50A	N20 . x - x - - - . ST63 N33F . x - x - - - . ST63						
88 □ 63A 80A 115A	N40 . x - x - - - . ST63 N60 . x - x - - - . ST63 N80 . x - x - - - . ST63						
132 □ 150A 250A	N100 . x - x - - - . ST63 N200 . x - x - - - . ST63						
7 steps		45°			11	48 □ 20A 32A	M10H . x x x - - - . ST73 M20 . x x x - - - . ST73
64 □ 32A 50A			N20 . x - x - - - . ST73 N33F . x - x - - - . ST73				
88 □ 63A 80A 115A			N40 . x - x - - - . ST73 N60 . x - x - - - . ST73 N80 . x - x - - - . ST73				
132 □ 150A 250A			N100 . x - x - - - . ST73 N200 . x - x - - - . ST73				

Ordering example: AC21 250A panel mounting, multi step switch 3-pole without off, 7 steps **N200 E ST73**

1) Plastic enclosed switches are delivered with switch type M10.

2) Cast enclosed switches are delivered with switch type N32.

Switching programs

Description	Wiring diagram	Switching angle	Number of cells ↓ Size ↓ AC21	Type	Design see page 6-8 E. Z. V. SMA. P. G.	Switch pro- gram	Escutcheon plate
Multi step switches 3-pole without Off ST.3							
8 steps		45°	12 48 □ 20A	M10H . x x x - - - . ST83 M20 . x x x - - - . ST83			
			64 □ 32A	N20 . x - x - - - . ST83 N33F . x - x - - - . ST83			
			88 □ 63A	N40 . x - x - - - . ST83 N60 . x - x - - - . ST83 N80 . x - x - - - . ST83			
			132 □ 150A	N100 . x - x - - - . ST83 N200 . x - x - - - . ST83			
			20A	32A			
9 steps		30°	14 48 □ 20A	M10H . x - x - - - . ST93 M20 . x - x - - - . ST93			
			64 □ 32A	N20 . x - x - - - . ST93 N33F . x - x - - - . ST93			
			88 □ 63A	N40 . x - x - - - . ST93 N60 . x - x - - - . ST93 N80 . x - x - - - . ST93			
			132 □ 150A	N100 . x - x - - - . ST93 N200 . x - x - - - . ST93			
			20A	32A			
10 steps		30°	15 48 □ 20A	M10H . x - x - - - . ST103 M20 . x - x - - - . ST103			
			64 □ 32A	N20 . x - x - - - . ST103 N33F . x - x - - - . ST103			
			88 □ 63A	N40 . x - x - - - . ST103 N60 . x - x - - - . ST103 N80 . x - x - - - . ST103			
			132 □ 150A	N100 . x - x - - - . ST103 N200 . x - x - - - . ST103			
			20A	32A			
11 steps		30°	17 48 □ 20A	M10H . x - x - - - . ST113 M20 . x - x - - - . ST113			
			64 □ 32A	N20 . x - x - - - . ST113 N33F . x - x - - - . ST113			
			88 □ 63A	N40 . x - x - - - . ST113 N60 . x - x - - - . ST113 N80 . x - x - - - . ST113			
			132 □ 150A	N100 . x - x - - - . ST113 N200 . x - x - - - . ST113			
			20A	32A			
12 steps		30°	18 48 □ 20A	M10H . x - x - - - . ST123 M20 . x - x - - - . ST123			
			64 □ 32A	N20 . x - x - - - . ST123 N33F . x - x - - - . ST123			
			88 □ 63A	N40 . x - x - - - . ST123 N60 . x - x - - - . ST123 N80 . x - x - - - . ST123			
			132 □ 150A	N100 . x - x - - - . ST123 N200 . x - x - - - . ST123			
			20A	32A			

Ordering example: AC21 250A panel mounting, multi step switch 3-pole without off, 12 steps

N200 E ST123

Switching programs

Description	Wiring diagram	Switching angle	Number of cells ↓ Size ↓ AC21	Type	Design see page 6-8 E. Z. V. SMA. P. G.	Switch pro- gram	Escutcheon plate
Multi step switches 3-pole with Off ST0.3							
2 steps		60°	3	48 □ 20A	M10H . x x x x x ¹⁾ - . ST023		
				32A	M20 . x x x x - - . ST023		
				64 □ 32A	N20 . x - x - x x . ST023		
				50A	N33F . x x x - x x ²⁾ . ST023		
				88 □ 63A	N40 . x - x - x - . ST023		
80A	N60 . x - x - x - . ST023						
115A	N80 . x - x - - - . ST023						
132 □ 150A	N100 . x - x - - - . ST023						
250A	N200 . x - x - - - . ST023						
3 steps		45°	5	48 □ 20A	M10H . x x x x x ¹⁾ - . ST033		
				32A	M20 . x x x x - - . ST033		
				64 □ 32A	N20 . x - x - x x . ST033		
				50A	N33F . x - x - x x ²⁾ . ST033		
				88 □ 63A	N40 . x - x - x - . ST033		
80A	N60 . x - x - x - . ST033						
115A	N80 . x - x - - - . ST033						
132 □ 150A	N100 . x - x - - - . ST033						
250A	N200 . x - x - - - . ST033						
4 steps		30°	6	48 □ 20A	M10H . x x x - x ¹⁾ - . ST043		
				32A	M20 . x x x - - - . ST043		
				64 □ 32A	N20 . x - x - x x . ST043		
				50A	N33F . x - x - x - . ST043		
				88 □ 63A	N40 . x - x - x - . ST043		
80A	N60 . x - x - x - . ST043						
115A	N80 . x - x - - - . ST043						
132 □ 150A	N100 . x - x - - - . ST043						
250A	N200 . x - x - - - . ST043						
5 steps		45°	9	48 □ 20A	M10H . x x x - - - . ST053		
				32A	M20 . x x x - - - . ST053		
				64 □ 32A	N20 . x - x - - - . ST053		
				50A	N33F . x - x - - - . ST053		
				88 □ 63A	N40 . x - x - - - . ST053		
80A	N60 . x - x - - - . ST053						
115A	N80 . x - x - - - . ST053						
132 □ 150A	N100 . x - x - - - . ST053						
250A	N200 . x - x - - - . ST053						
6 steps		45°	11	48 □ 20A	M10H . x x x - - - . ST063		
				32A	M20 . x x x - - - . ST063		
				64 □ 32A	N20 . x - x - - - . ST063		
				50A	N33F . x - x - - - . ST063		
				88 □ 63A	N40 . x - x - - - . ST063		
80A	N60 . x - x - - - . ST063						
115A	N80 . x - x - - - . ST063						
132 □ 150A	N100 . x - x - - - . ST063						
250A	N200 . x - x - - - . ST063						

Ordering example: AC21 250A panel mounting, multi step switch 3-pole with off, 6 steps **N200 E ST063**

1) Plastic enclosed switches are delivered with switch type M10.

2) Cast enclosed switches are delivered with switch type N32.

Switching programs

Description	Wiring diagram	Switching angle	Number of cells ↓ Size ↓ AC21	Type	Design see page 6-8 E. Z. V. SMA. P. G.	Switch pro- gram	Escutcheon plate
Multi step switches 3-pole with Off ST0.3							
7 steps		45°	12 48 □ 20A	M10H . x x x - - - . ST073 M20 . x x x - - - . ST073			
			64 □ 32A	N20 . x - x - - - . ST073 N33F . x - x - - - . ST073			
			88 □ 63A	N40 . x - x - - - . ST073 N60 . x - x - - - . ST073 N80 . x - x - - - . ST073			
			132 □ 150A	N100 . x - x - - - . ST073 N200 . x - x - - - . ST073			
8 steps		30°	14 48 □ 20A	M10H . x - x - - - . ST083 M20 . x - x - - - . ST083			
			64 □ 32A	N20 . x - x - - - . ST083 N33F . x - x - - - . ST083			
			88 □ 63A	N40 . x - x - - - . ST083 N60 . x - x - - - . ST083 N80 . x - x - - - . ST083			
			132 □ 150A	N100 . x - x - - - . ST083 N200 . x - x - - - . ST083			
9 steps		30°	15 48 □ 20A	M10H . x - x - - - . ST093 M20 . x - x - - - . ST093			
			64 □ 32A	N20 . x - x - - - . ST093 N33F . x - x - - - . ST093			
			88 □ 63A	N40 . x - x - - - . ST093 N60 . x - x - - - . ST093 N80 . x - x - - - . ST093			
			132 □ 150A	N100 . x - x - - - . ST093 N200 . x - x - - - . ST093			
10 steps		30°	17 48 □ 20A	M10H . x - x - - - . ST0103 M20 . x - x - - - . ST0103			
			64 □ 32A	N20 . x - x - - - . ST0103 N33F . x - x - - - . ST0103			
			88 □ 63A	N40 . x - x - - - . ST0103 N60 . x - x - - - . ST0103 N80 . x - x - - - . ST0103			
			132 □ 150A	N100 . x - x - - - . ST0103 N200 . x - x - - - . ST0103			
11 steps		30°	18 48 □ 20A	M10H . x - x - - - . ST0113 M20 . x - x - - - . ST0113			
			64 □ 32A	N20 . x - x - - - . ST0113 N33F . x - x - - - . ST0113			
			88 □ 63A	N40 . x - x - - - . ST0113 N60 . x - x - - - . ST0113 N80 . x - x - - - . ST0113			
			132 □ 150A	N100 . x - x - - - . ST0113 N200 . x - x - - - . ST0113			

Ordering example: AC21 250A panel mounting, multi step switch 3-pole with off, 11 steps N200 E ST0113

Mini-Cam Switches M4H

Panel mounting E, IP40



Central fixing Z



Central fixing without escutcheon plate ZO

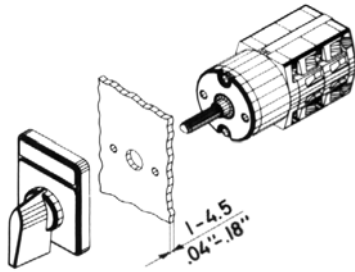

Mounting holes

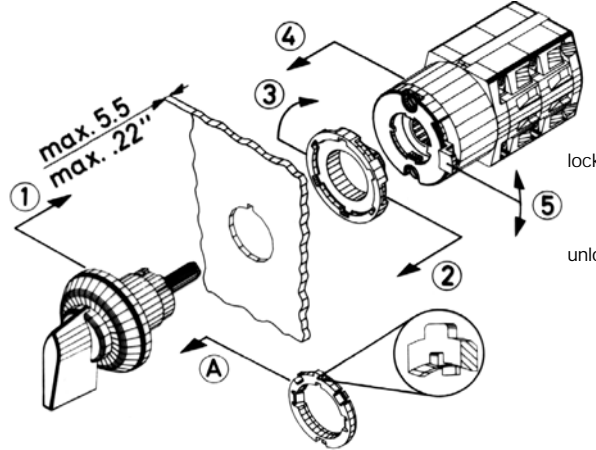
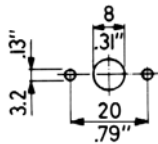

Central fixing 16mm

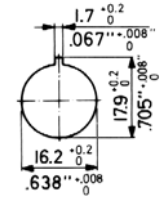

unlock Central fixing 22mm

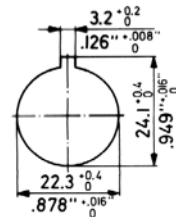

Single hole mountings are generally delivered for a 16mm (.64") mounting. Using the forwarded adapter ring, it is possible to alter the single hole mountings from 22mm (.88"). For that purpose the adapter ring has to be attached onto the threaded part of the body in such a manner, that
 1. the flat side of the adapter ring shows towards the front seal and
 2. the inner nose fits into the notch of the body.
 The adapter ring has to be pushed towards the front seal.

Optional extras	ordering code	for design	M4H Z ... +SRE	M4H Z ... +SA.	M4H ZO ... +SA.	M4H Z ... +SRE+SA.
Additional escutcheon plate	+SRE	E, Z, ZO				
Additional escutcheon plate	+SRE2	E, Z, ZO				
Key operated switch with lock KABA	+SA1	Z, ZO				
with lock Ronis	+SA2	Z, ZO				

Wrench J7400
for switches M4H with central fixing is necessary

Panel mounting E

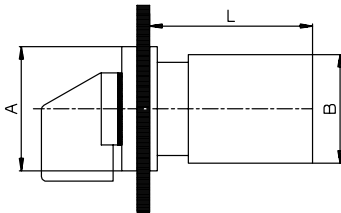

Central fixing Z, ZO

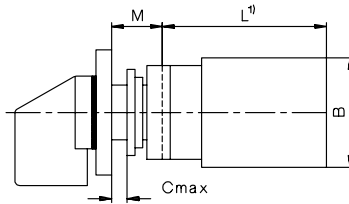

ZO

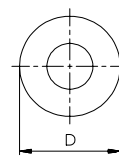

Z

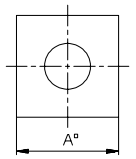

Type	A	B	D	M	Dimension L for ... cells								
					1	2	3	4	5	6	7	8	
M4H	mm	30	28	29,5	12,5	38,5	50,5	62,5	74,5	86,5	98,5	110,5	122,5

Technical data

Type	according to specifications	AC21A		AC15		Motor rating AC3							
		General use	10A/500V 10A/300V	2,5A A300	1,5A A300	3 phase 3-pole			1 phase 2-pole				
M4H	IEC, VDE, BS, SEV UL, CSA					110	220	380	110	220	380		
						120	240	440	120	240	277	440	
						0,65	1,5	2,2	0,3	0,55	-	0,75	
						0,75	1	-	0,33	0,75	0,75	-	

Type	according to specifications	Volt	Motor rating AC23			additional data for wiring according to UL and CSA					
			3-pole	2-pole	3-pole	Type	temp. rating of wire	torque value for field wiring terminals			
M4H	IEC, VDE, BS, SEV UL, CSA	kW HP	0,75 1	1,8 2,5	3 4	110	220	380	M4H	60/75°C	0,6Nm / 5lb · inch
			-	-	-	120	240	440			
						0,37	0,75	1,1			
						-	-	-			

Type	type of wire	temp. rating of wire	torque value for field wiring terminals
M4H	copper wire only	60/75°C	0,6Nm / 5lb · inch

Switch programs

Description	Wiring diagram	AC21 500V 10A AC15 230V 2,5A AC3 4x400V 2,2kW	escutch. 30 x 30	numb. of cells	Type	Design			Switch pro- gram
						.E. ↓	.Z. ↓	.ZO. ↓	
On-Off-switch A									
1-pole				1	M4H .	x	x	x	. A1
2-pole				1	M4H .	x	x	x	. A2
3-pole				2	M4H .	x	x	x	. A3
4-pole				2	M4H .	x	x	x	. A4
6-pole				3	M4H .	x	x	x	. A6
Changeover switch U									
1-pole				1	M4H .	x	x	x	. U1
2-pole				2	M4H .	x	x	x	. U2
3-pole				3	M4H .	x	x	x	. U3
4-pole				4	M4H .	x	x	x	. U4
Changeover switch without off W									
1-pole				1	M4H .	x	x	x	. W1
2-pole				2	M4H .	x	x	x	. W2
3-pole				3	M4H .	x	x	x	. W3
4-pole				4	M4H .	x	x	x	. W4
6-pole				6	M4H .	x	x	x	. W6
Reversing switch WU									
2-pole				2	M4H .	x	x	x	. WU2
3-pole				3	M4H .	x	x	x	. WU3
3-pole with spring return to 0				3	M4H .	x	x	x	. WU3R2
Star-delta switch SD									
1 rotary direction				4	M4H .	x	x	x	. SD
both rotary directions				5	M4H .	x	x	x	. SDR
Changeover with spring return UR									
1-pole				1	M4H .	x	x	x	. UR1
2-pole				2	M4H .	x	x	x	. UR2
3-pole				3	M4H .	x	x	x	. UR3
Start switch									
1-pole				1	M4H .	x	x	x	. SE
Stop switch									
1-pole				1	M4H .	x	x	x	. SA

Ordering example: Stop switch, 1-pole, Central fixing: M4H Z SA

Mini-Cam Switches M4H

Switch programs

Description	Wiring diagram	AC21 500V 10A AC15 230V 2,5A AC3 4x400V 2,2kW	escutch. 30 x 30	numb. of cells	Type	Design			Switch pro- gram
						.E. ↓	.Z. ↓	.ZO. ↓	
Start-Stop switch				1	M4H	x	x	x	. SEA
Start-Stop switch position START with spring return to 1				1	M4H	x	x	x	. S392
Start-Stop switch for reversing contactors				2	M4H	x	x	x	. S2EA
Voltmeter selector switch V 3 line voltages				2	M4H	x	x	x	. V3
3 phase voltages				2	M4H	x	x	x	. V0
3 line voltages 3 phase voltages				3	M4H	x	x	x	. V1
Ammeter selector switch A 1-pole, 3 current transformer				4	M4H	x	x	x	. M31
Gang switch GR 2 circuits A and B 1-pole 0 - A - A+B				1	M4H	x	x	x	. GR11
2 circuits A and B 1-pole 0 - A - B - A+B				1	M4H	x	x	x	. GR12
3 circuits A, B and C 1-pole				2	M4H	x	x	x	. GR14
Multi step switch without 0 ST 3 steps, 1-pole				2	M4H	x	x	x	. ST31
3 steps, 2-pole				3	M4H	x	x	x	. ST32
3 steps, 3-pole				5	M4H	x	x	x	. ST33





Ordering example: Multi step switch without 0, 3 steps, 3-pole, panel mounting: **M4H E ST33**

Switch programs

Description	Wiring diagram	AC21 500V 10A AC15 230V 2,5A AC3 4x400V 2,2kW	escutch. 30 x 30	numb. of cells	Type	Design			Switch pro- gram
						.E. ↓	.Z. ↓	.ZO. ↓	
Multi step switch without 0 ST									
4 steps, 1-pole				2	M4H .	x	x	x	. ST41
4 steps, 2-pole				4	M4H .	x	x	x	. ST42
4 steps, 3-pole				6	M4H .	x	x	x	. ST43
5 steps, 1-pole				3	M4H .	x	x	x	. ST51
5 steps, 2-pole				5	M4H .	x	x	x	. ST52
6 steps, 1-pole				3	M4H .	x	x	x	. ST61
6 steps, 2-pole				6	M4H .	x	x	x	. ST62
Multi step switch with 0 ST0.									
2 steps, 1-pole				1	M4H .	x	x	x	. ST021
2 steps, 2-pole				2	M4H .	x	x	x	. ST022
2 steps, 3-pole				3	M4H .	x	x	x	. ST023
3 steps, 1-pole				2	M4H .	x	x	x	. ST031
3 steps, 2-pole				3	M4H .	x	x	x	. ST032
3 steps, 3-pole				5	M4H .	x	x	x	. ST033
4 steps, 1-pole				2	M4H .	x	x	x	. ST041
4 steps, 2-pole				4	M4H .	x	x	x	. ST042
4 steps, 3-pole				6	M4H .	x	x	x	. ST043
5 steps, 1-pole				3	M4H .	x	x	x	. ST051
5 steps, 2-pole				5	M4H .	x	x	x	. ST052
6 steps, 1-pole				4	M4H .	x	x	x	. ST061
7 steps, 1-pole				4	M4H .	x	x	x	. ST071
8 steps, 1-pole				5	M4H .	x	x	x	. ST081
9 steps, 1-pole				5	M4H .	x	x	x	. ST091
10 steps, 1-pole				6	M4H .	x	x	x	. ST0101

Ordering example: Multi step switch with 0, 10 steps, 1-pole, Central fixing without escutcheon plate: M4H ZO ST0101



Emergency-Stop-Main Switches for Panel Mounting, lockable, IP65

	max. padlocks	AC21 690V	AC23 3x400V	plate IP65	Type	No.	Pack pcs.	Weight kg/pcs.
3-pole, padlock device SV1 								
		20A	5,5kW	48 □ ¹⁾	LTS20 EHN1 A3		1	0,15
		25A	7,5kW	48 □ ¹⁾	LTS25 EHN1 A3		1	0,15
		32A	11kW	48 □ ¹⁾	LTS32 EHN1 A3		1	0,15
		40A	15kW	48 □ ¹⁾	LTS40 EHN1 A3		1	0,15
		63A	22kW	48 □ ¹⁾	LTS63 EHN1 A3		1	0,17
		80A	22kW	48 □ ¹⁾	LTS80 EHN1 A3		1	0,17
4-pole, padlock device SV1 								
		20A	5,5kW	48 □ ¹⁾	LTS20 EHN1 A4		1	0,19
		25A	7,5kW	48 □ ¹⁾	LTS25 EHN1 A4		1	0,19
		32A	11kW	48 □ ¹⁾	LTS32 EHN1 A4		1	0,19
		40A	15kW	48 □ ¹⁾	LTS40 EHN1 A4		1	0,19
		63A	22kW	48 □ ¹⁾	LTS63 EHN1 A4		1	0,21
		80A	22kW	48 □ ¹⁾	LTS80 EHN1 A4		1	0,21
3-pole, padlock device SV4(34) 								
		20A	5,5kW	64 □	LTS20 EHN4 A3		1	0,17
		25A	7,5kW	64 □	LTS25 EHN4 A3		1	0,17
		32A	11kW	64 □	LTS32 EHN4 A3		1	0,17
		40A	15kW	64 □	LTS40 EHN4 A3		1	0,17
		63A	22kW	64 □	LTS63 EHN4 A3		1	0,19
		80A	22kW	64 □	LTS80 EHN4 A3		1	0,19
		80A	30kW	64 □	LT80 EHN34 T300		1	0,46
		100A	37kW	64 □	LT100 EHN34 T300		1	0,46
		125A	45kW	88 □	LT125 EHN34 T300		1	1,16
		160A	55kW	88 □	LT160 EHN34 T300		1	1,16
4-pole, padlock device SV4(34) 								
		20A	5,5kW	64 □ ²⁾	LTS20 EHN4 A4		1	0,20
		25A	7,5kW	64 □ ²⁾	LTS25 EHN4 A4		1	0,20
		32A	11kW	64 □ ²⁾	LTS32 EHN4 A4		1	0,20
		40A	15kW	64 □ ²⁾	LTS40 EHN4 A4		1	0,20
		63A	22kW	64 □ ²⁾	LTS63 EHN4 A4		1	0,23
		80A	22kW	64 □ ²⁾	LTS80 EHN4 A4		1	0,23
		80A	30kW	64 □	LT80 EHN34 T400		1	0,57
		100A	37kW	64 □	LT100 EHN34 T400		1	0,57
		125A	45kW	88 □	LT125 EHN34 T400		1	1,55
		160A	55kW	88 □	LT160 EHN34 T400		1	1,55

6-pole, 8-pole

on request







Main Switches Emergency-Stop for Single Hole Mounting, lockable, IP65

3-pole, padlock device SV1 								
		20A	5,5kW	48 □	LTS20 ZHN1 A3		1	0,16
		25A	7,5kW	48 □	LTS25 ZHN1 A3		1	0,16
		32A	11kW	48 □	LTS32 ZHN1 A3		1	0,16
		40A	15kW	48 □	LTS40 ZHN1 A3		1	0,16
4-pole, padlock device SV1 								
		20A	5,5kW	48 □	LTS20 ZHN1 A4		1	0,20
		25A	7,5kW	48 □	LTS25 ZHN1 A4		1	0,20
		32A	11kW	48 □	LTS32 ZHN1 A4		1	0,20
		40A	15kW	48 □	LTS40 ZHN1 A4		1	0,20

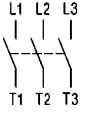

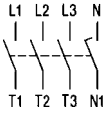
1) Types with padlock device 64 □ type suffix **64**, ordering example: LTS32 EHN164 A3, on request

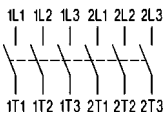
2) Types with padlock device 88 □ type suffix **88**, ordering example: LTS32 EHN488 A3, on request

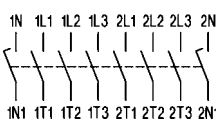
Emergency-Stop-Main Switches, Base Mounting with Door Clutch, Padlock Device for Single-Hole Mounting Depth X is adjustable (delivered with X_{max} see page 50), IP65

	max. padlocks	AC21 690V	AC23 3x400V	plate IP65	Type	No.	Pack pcs.	Weight kg/pcs.
3-pole, padlock device SV4  	☰	20A	5,5kW	64 □	LTS20 VZVHN4 A3		1	0,19
		25A	7,5kW	64 □	LTS25 VZVHN4 A3		1	0,19
		32A	11kW	64 □	LTS32 VZVHN4 A3		1	0,19
		40A	15kW	64 □	LTS40 VZVHN4 A3		1	0,19
		63A	22kW	64 □	LTS63 VZVHN4 A3		1	0,22
		80A	22kW	64 □	LTS80 VZVHN4 A3		1	0,22
		4-pole, padlock device SV4  	☰	20A	5,5kW	64 □	LTS20 VZVHN4 A4	
25A	7,5kW			64 □	LTS25 VZVHN4 A4		1	0,20
32A	11kW			64 □	LTS32 VZVHN4 A4		1	0,20
40A	15kW			64 □	LTS40 VZVHN4 A4		1	0,20
63A	22kW			64 □	LTS63 VZVHN4 A4		1	0,26
80A	22kW			64 □	LTS80 VZVHN4 A4		1	0,26
6-pole, padlock device SV4  	☰			20A	5,5kW	64 □	LTS20 VZVHN4 A6	
		25A	7,5kW	64 □	LTS25 VZVHN4 A6		1	0,32
		32A	11kW	64 □	LTS32 VZVHN4 A6		1	0,32
		40A	15kW	64 □	LTS40 VZVHN4 A6		1	0,32
		63A	22kW	64 □	LTS63 VZVHN4 A6		1	0,37
		80A	22kW	64 □	LTS80 VZVHN4 A6		1	0,37
		8-pole, padlock device SV4  	☰	20A	5,5kW	64 □	LTS20 VZVHN4 A8	
25A	7,5kW			64 □	LTS25 VZVHN4 A8		1	0,34
32A	11kW			64 □	LTS32 VZVHN4 A8		1	0,34
40A	15kW			64 □	LTS40 VZVHN4 A8		1	0,34
63A	22kW			64 □	LTS63 VZVHN4 A8		1	0,45
80A	22kW			64 □	LTS80 VZVHN4 A8		1	0,45

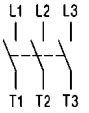
Emergency-Stop-Main Switches, Base Mounting with Door Clutch, Padlock Device for Four-Hole Mounting Depth X is adjustable (delivered with T_{max} see page 50), IP65, (IP40)

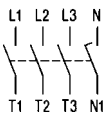
3-pole, padlock device SV4(SV34)  	☰	20A	5,5kW	64 □	LTS20 VHN4 A3		1	0,20
		25A	7,5kW	64 □	LTS25 VHN4 A3		1	0,20
		32A	11kW	64 □	LTS32 VHN4 A3		1	0,20
		40A	15kW	64 □	LTS40 VHN4 A3		1	0,20
		63A	22kW	64 □	LTS63 VHN4 A3		1	0,24
		80A	22kW	64 □	LTS80 VHN4 A3		1	0,24
		80A	30kW	64 □	LT80 VHN34 T300 ¹⁾		1	0,60
		100A	37kW	64 □	LT100 VHN34 T300 ¹⁾		1	0,61
		125A	45kW	88 □	LT125 VHN34 T300 ¹⁾		1	1,38
		160A	55kW	88 □	LT160 VHN34 T300 ¹⁾		1	1,38
4-pole, padlock device SV4(SV34)  	☰	20A	5,5kW	64 □	LTS20 VHN4 A4		1	0,21
		25A	7,5kW	64 □	LTS25 VHN4 A4		1	0,21
		32A	11kW	64 □	LTS32 VHN4 A4		1	0,21
		40A	15kW	64 □	LTS40 VHN4 A4		1	0,21
		63A	22kW	64 □	LTS63 VHN4 A4		1	0,28
		80A	22kW	64 □	LTS80 VHN4 A4		1	0,28
		80A	30kW	64 □	LT80 VHN34 T400 ¹⁾		1	0,71
		100A	37kW	64 □	LT100 VHN34 T400 ¹⁾		1	0,71
		125A	45kW	88 □	LT125 VHN34 T400 ¹⁾		1	1,77
		160A	55kW	88 □	LT160 VHN34 T400 ¹⁾		1	1,77

6-pole, 8-pole











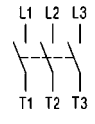

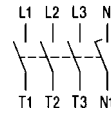

on request

Emergency-Stop-Main Switches, Base Mounting with Door Clutch, Padlock Device for Single-Hole Mounting Depth X is not adjustable, IP65 on request ²⁾

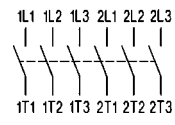



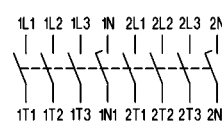

1) IP40

2) For order the installation depth X is necessary, see page 50, Preference value for X: 80, 85, 104, 129 (tolerance -3, +1,5)

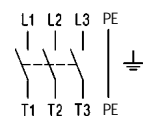
Maintenance and Safety Switches, in Plastic Enclosure, lockable, IP65

	max. padlocks	AC21 690V	AC23 3x400V	plate IP65	Type	No.	Pack pcs.	Weight kg/pcs.		
3-pole, padlock device SV1  		20A	5,5kW	52x45	LTS20 SMAHN1 A3		1	0,15		
		25A	7,5kW	52x45	LTS25 SMAHN1 A3		1	0,15		
		32A	11kW	52x45	LTS32 SMAHN1 A3		1	0,15		
		40A	15kW	52x45	LTS40 SMAHN1 A3		1	0,15		
		63A	22kW	52x45	LTS63 SMAHN1 A3		1	0,18		
		80A	22kW	52x45	LTS80 SMAHN1 A3		1	0,18		
		80A	30kW	70x45	LT80 SMAHN1 T300		1	0,37		
		100A	37kW	70x45	LT100 SMAHN1 T300		1	0,37		
		4-pole, padlock device SV1  		20A	5,5kW	52x45	LTS20 SMAHN1 A4		1	0,16
				25A	7,5kW	52x45	LTS25 SMAHN1 A4		1	0,16
32A	11kW			52x45	LTS32 SMAHN1 A4		1	0,16		
	40A		15kW	52x45	LTS40 SMAHN1 A4		1	0,16		
	63A		22kW	52x45	LTS63 SMAHN1 A4		1	0,21		
	80A		22kW	52x45	LTS80 SMAHN1 A4		1	0,21		
	6-pole, padlock device SV1(64)  			20A	5,5kW	52x45	LTS20 SMAHN1 A6		1	0,29
				25A	7,5kW	52x45	LTS25 SMAHN1 A6		1	0,29
				32A	11kW	52x45	LTS32 SMAHN1 A6		1	0,29
				40A	15kW	52x45	LTS40 SMAHN1 A6		1	0,29
63A		22kW		97x45	LTS63 SMAHN164 A6		1	0,34		
80A		22kW		97x45	LTS80 SMAHN164 A6		1	0,34		
8-pole, padlock device SV164  				20A	5,5kW	97x45	LTS20 SMAHN164 A8		1	0,31
				25A	7,5kW	97x45	LTS25 SMAHN164 A8		1	0,31
				32A	11kW	97x45	LTS32 SMAHN164 A8		1	0,31
				40A	15kW	97x45	LTS40 SMAHN164 A8		1	0,31
	63A		22kW	126x45	LTS63 SMAHN164 A8		1	0,42		
	80A		22kW	126x45	LTS80 SMAHN164 A8		1	0,42		

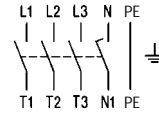
Maintenance and Safety Switches, in Plastic Enclosure, lockable, IP65





3-pole, padlock device SV4(SV34)  		20A	5,5kW	64 □	LTS20 PFHN4 A3		1	0,32
		25A	7,5kW	64 □	LTS25 PFHN4 A3		1	0,32
		32A	11kW	64 □	LTS32 PFHN4 A3		1	0,32
		40A	15kW	64 □	LTS40 PFHN4 A3		1	0,32
		63A	22kW	64 □	LTS63 PFHN4 A3		1	0,60
		80A	22kW	64 □	LTS80 PFHN4 A3		1	0,60
		80A	30kW	64 □	LT80 PFHN34 T300		1	1,36
		80A	37kW	64 □	LT100 PFHN34 T300		1	1,36
		125A	45kW	88 □	LT125 PFHN34 T300		1	2,09
		160A	55kW	88 □	LT160 PFHN34 T300		1	2,09
4-pole, padlock device SV4(SV34)  		20A	5,5kW	64 □	LTS20 PFHN4 A4		1	0,33
		25A	7,5kW	64 □	LTS25 PFHN4 A4		1	0,33
		32A	11kW	64 □	LTS32 PFHN4 A4		1	0,33
		40A	15kW	64 □	LTS40 PFHN4 A4		1	0,33
		63A	22kW	64 □	LTS63 PFHN4 A4		1	0,64
		80A	22kW	64 □	LTS80 PFHN4 A4		1	0,64
		70A	30kW	64 □	LT80 PFHN34 T400		1	1,50
		80A	37kW	64 □	LT100 PFHN34 T400		1	1,50
		125A	45kW	88 □	LT125 PFHN34 T400		1	2,47
		160A	55kW	88 □	LT160 PFHN34 T400		1	2,47

6-pole, 8-pole

on request

Add-on modules (4th pole, aux. contacts, PE-terminal, terminal cover plates, escutcheon plates) see page 51

Main Switches for Panel Mounting, lockable, IP65



	max. padlocks	AC21 690V	AC23 3x400V	plate IP65	Type	No.	Pack pcs.	Weight kg/pcs.
3-pole, padlock device SV1 								
		20A	5,5kW	48 □ ¹⁾	LTS20 EH1 A3		1	0,15
		25A	7,5kW	48 □ ¹⁾	LTS25 EH1 A3		1	0,15
		32A	11kW	48 □ ¹⁾	LTS32 EH1 A3		1	0,15
		40A	15kW	48 □ ¹⁾	LTS40 EH1 A3		1	0,15
		63A	22kW	48 □ ¹⁾	LTS63 EH1 A3		1	0,17
		80A	22kW	48 □ ¹⁾	LTS80 EH1 A3		1	0,17
4-pole, padlock device SV1 								
		20A	5,5kW	48 □ ¹⁾	LTS20 EH1 A4		1	0,19
		25A	7,5kW	48 □ ¹⁾	LTS25 EH1 A4		1	0,19
		32A	11kW	48 □ ¹⁾	LTS32 EH1 A4		1	0,19
		40A	15kW	48 □ ¹⁾	LTS40 EH1 A4		1	0,19
		63A	22kW	48 □ ¹⁾	LTS63 EH1 A4		1	0,21
		80A	22kW	48 □ ¹⁾	LTS80 EH1 A4		1	0,21
6-pole, 8-pole, padlock device SV164					on request			
3-pole, padlock device SV4(34) 								
		20A	5,5kW	64 □	LTS20 EH4 A3		1	0,17
		25A	7,5kW	64 □	LTS25 EH4 A3		1	0,17
		32A	11kW	64 □	LTS32 EH4 A3		1	0,17
		40A	15kW	64 □	LTS40 EH4 A3		1	0,17
		63A	22kW	64 □	LTS63 EH4 A3		1	0,19
		80A	22kW	64 □	LTS80 EH4 A3		1	0,19
		80A	30kW	64 □	LT80 EH34 T300		1	0,46
		100A	37kW	64 □	LT100 EH34 T300		1	0,46
		125A	45kW	88 □	LT125 EH34 T300		1	1,16
		160A	55kW	88 □	LT160 EH34 T300		1	1,16
4-pole, padlock device SV4(34) 								
		20A	5,5kW	64 □ ¹⁾	LTS20 EH4 A4		1	0,20
		25A	7,5kW	64 □ ¹⁾	LTS25 EH4 A4		1	0,20
		32A	11kW	64 □ ¹⁾	LTS32 EH4 A4		1	0,20
		40A	15kW	64 □ ¹⁾	LTS40 EH4 A4		1	0,20
		63A	22kW	64 □ ¹⁾	LTS63 EH4 A4		1	0,23
		80A	22kW	64 □ ¹⁾	LTS80 EH4 A4		1	0,23
		80A	30kW	64 □	LT80 EH34 T400		1	0,57
		100A	37kW	64 □	LT100 EH34 T400		1	0,57
		125A	45kW	88 □	LT125 EH34 T400		1	1,55
		160A	55kW	88 □	LT160 EH34 T400		1	1,55
6-pole, 8-pole, padlock device SV4					on request			

Add-on modules see page 51

- 1) Types with padlock device 64 □ type suffix **64**, ordering example: LTS32 EH1**64** A3, on request
- 2) Types with padlock device 88 □ type suffix **88**, ordering example: LTS32 EH4**88** A3, on request

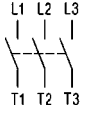

Main Switches, Base Mounting with Door Clutch, Padlock Device for Single-Hole Mounting

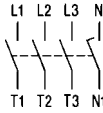
Depth X is adjustable (delivered with X_{max} see below), IP65

	max. padlocks	AC21 690V	AC23 3x400V	plate IP65	Type	Order. No.	Pack pcs.	Weight kg/pcs.
3-pole, padlock device SV4  	☰	20A	5,5kW	64 □ ¹⁾	LTS20 VZVH4 A3		1	0,19
		25A	7,5kW	64 □ ¹⁾	LTS25 VZVH4 A3		1	0,19
		32A	11kW	64 □ ¹⁾	LTS32 VZVH4 A3		1	0,19
		40A	15kW	64 □ ¹⁾	LTS40 VZVH4 A3		1	0,19
		63A	22kW	64 □ ¹⁾	LTS63 VZVH4 A3		1	0,22
		80A	22kW	64 □ ¹⁾	LTS80 VZVH4 A3		1	0,22
4-pole, padlock device SV4  	☰	20A	5,5kW	64 □ ¹⁾	LTS20 VZVH4 A4		1	0,20
		25A	7,5kW	64 □ ¹⁾	LTS25 VZVH4 A4		1	0,20
		32A	11kW	64 □ ¹⁾	LTS32 VZVH4 A4		1	0,20
		40A	15kW	64 □ ¹⁾	LTS40 VZVH4 A4		1	0,20
		63A	22kW	64 □ ¹⁾	LTS63 VZVH4 A4		1	0,26
		80A	22kW	64 □ ¹⁾	LTS80 VZVH4 A4		1	0,26
6-pole, 8-pole				on request				

Main Switches, Base Mounting with Door Clutch, Padlock Device for Four-Hole Mounting

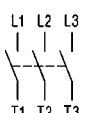
Depth X is adjustable (delivered with T_{max} see below), IP65, (IP40)

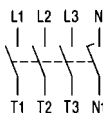
3-pole, padlock device SV4(SV34)  	☰	20A	5,5kW	64 □	LTS20 VH4 A3		1	0,20
		25A	7,5kW	64 □	LTS25 VH4 A3		1	0,20
		32A	11kW	64 □	LTS32 VH4 A3		1	0,20
		40A	15kW	64 □	LTS40 VH4 A3		1	0,20
		63A	22kW	64 □	LTS63 VH4 A3		1	0,24
		80A	22kW	64 □	LTS80 VH4 A3		1	0,24
		80A	30kW	64 □	LT80 VH34 T300 ¹⁾		1	0,60
		100A	37kW	64 □	LT100 VH34 T300 ¹⁾		1	0,60
4-pole, padlock device SV4(SV34)  	☰	20A	5,5kW	64 □	LTS20 VH4 A4		1	0,21
		25A	7,5kW	64 □	LTS25 VH4 A4		1	0,21
		32A	11kW	64 □	LTS32 VH4 A4		1	0,21
		40A	15kW	64 □	LTS40 VH4 A4		1	0,21
		63A	22kW	64 □	LTS63 VH4 A4		1	0,28
		80A	22kW	64 □	LTS80 VH4 A4		1	0,28
		80A	30kW	64 □	LT80 VH34 T400 ¹⁾		1	0,71
		100A	37kW	64 □	LT100 VH34 T400 ¹⁾		1	0,71
	125A	45kW	88 □	LT125 VH34 T400 ¹⁾		1	1,77	
	160A	55kW	88 □	LT160 VH34 T400 ¹⁾		1	1,77	
6-pole, 8-pole				on request				

1) IP40

Depth Single Hole Mounting Ø22mm LTS.. VZV..

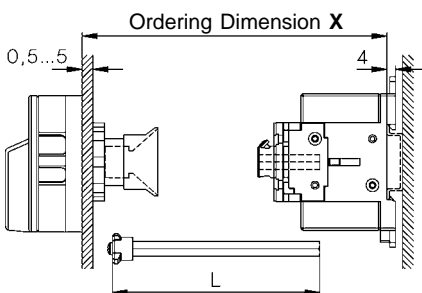

Type		X min	X max	L
LTS.. VZV..	3, 4-pole	91 -	190	X - 40±3
LTS.. VZV..	6, 8-pole	111 -	190	X - 60±3

greater X- and T-Dimensions (max. 380mm for LTS..) on request



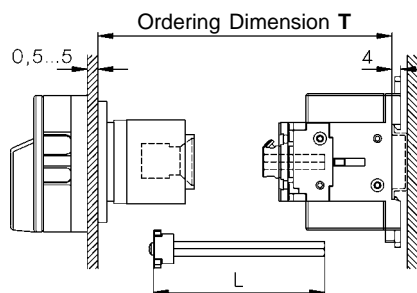







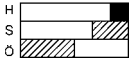

4-Hole Mounting LTS.. V(HN).. (3, 4-pole)

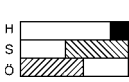













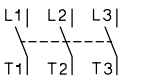

Type		T min	T max	L
LTS.. VH..		111 -	190	T - 60±3

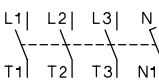
Type		T min	T max
LT80 VH..		110 -	380
LT100 VH..		110 -	450
LT125/160 VH..		120 -	450

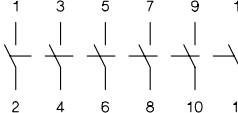
Add-on Modules for main switches and Switch Disconnectors

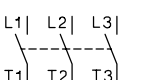
	for switch	for designs panel- base- mounting	distrib. boards	Type	No.	Pack pcs.	Weight kg/pcs	
4th add-on neutral switching pole								
	N	LTS20 to LTS40	x	-	-	N40E	1	0,035
		LTS63 to LTS80	x	-	-	N80E	1	0,042
	N1	LTS20 to LTS40	-	x	x	N40V	1	0,035
		LTS63 to LTS80	-	x	x	N80V	1	0,042
Aux. contact block 1NO + 1NC								
		LTS30 to LT70	x	x	x	LH11	1	0,02
		LT80 to LT100	x	-	-	LTY-E11	1	0,02
		LT80 to LT100	-	x	x	LTY-V11	1	0,02
Aux. contact block 1NO + 1NC overlapping								
		LTS20 to LTS80	x	x	x	LH11X	1	0,02
		LT80 to LT100	x	-	-	LTY-E11U	1	0,02
		LT80 to LT100	-	x	x	LTY-V11U	1	0,02
PE-Terminal								
	PE	LTS20 to LTS80	x	-	-	PE80E	1	0,04
		LT80 to LT100	x	x	-	LTY-E	1	0,1
		LT125 to 160	x	-	-	LTXE-E/E	1	0,2
	PE	LTS20 to LTS80	-	x	-	PE80V	1	0,04
LT125 to 160		-	x	-	LTXE-E/V	1	0,2	
N-Terminal								
	N	LTS20 to LTS80	x	-	-	PEN80E	1	0,04
		LT80 to LT100	x	x	-	LTY-N	1	0,1
		LT125/160	x	-	-	LTXE-N/E	1	0,2
	N	LTS20 to LTS80	-	x	-	PEN80V	1	0,04
		LT125 to 160	-	x	-	LTXE-N/V	1	0,2
Additional escutcheon plate yellow marked with: HAUPTSCHALTER								
	48mm	LT.. .HN1..	x	x	-	A91501	1	0,003
	64mm	LT.. .HN4..	x	x	-	E91501	1	0,005
Additional escutcheon plate yellow marked with: MAIN SWITCH								
	48mm	LT.. .HN1..	x	x	-	A91524	1	0,003
	64mm	LT.. .HN4..	x	x	-	E91524	1	0,005
Terminal cover plate 3-pole								
	LTS20 to LTS40	-	x	x	KLAD40	1	0,005	
	LTS20 bis LTS40	x	-	-	KLAD70	1	0,005	
	LTS63 to LTS80	x	x	x	KLAD70	1	0,005	
	LT80 to LT100	x	x	-	Y-KLAD3	1	0,01	
	LT125 to LT160	x	x	-	XX-KLAD3	1	0,02	
Terminal cover plate for 4. Pole								
	Mains	LTS63 to LTS80	x	x	x	KLAD70N	1	0,002
	Load circuit	LTS63 to LTS80	x	x	x	KLAD70N1	1	0,002
Terminal cover plate 4-pole								
	LTS20 to LTS40	-	x	x	KLAD40	1	0,005	
	LT80 to LT100	x	x	-	Y-KLAD4	1	0,01	
	LT125 to LT160	x	x	-	XX-KLAD4	1	0,02	
Flat Terminal 6,3 x 0,8mm								
	LTS20 to LTS40	-	x	x	LG11073	10	0,001	

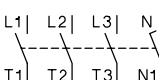
Main Switches for panel mounting, Cam Switches

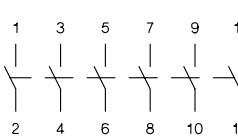
		AC21 A	AC23 kW	Plate	with Emergency-Off Type	without Emergency-Off Type
	2-polig 	20	7,5	48 □	M10H EHN1 A2+731	M10H EH1 A2+731
	3-polig	20	7,5	48 □	M10H EHN1 A3+731	M10H EH1 A3+731
	4-polig	20	7,5	48 □	M10H EHN1 A4+731	M10H EH1 A4+731
	6-polig	20	7,5	48 □	M10H EHN1 A6+731	M10H EH1 A6+731
	3-polig  	63	22	88 □	N40 EHN3 A3	N40 EH3 A3
		80	30	88 □	N60 EHN3 A3	N60 EH3 A3
		115	45	88 □	N80 EHN3 A3	N80 EH3 A3
	4-polig  	63	22	88 □	N40 EHN3 A4	N40 EH3 A4
		80	30	88 □	N60 EHN3 A4	N60 EH3 A4
		115	45	88 □	N80 EHN3 A4	N80 EH3 A4
	6-polig  	63	22	88 □	N40 EHN3 A6 *	N40 EH3 A6 *
		80	30	88 □	N60 EHN3 A6 *	N60 EH3 A6 *
		115	45	88 □	N80 EHN3 A6 *	N80 EH3 A6 *
		150	55	132 □	N100 EHN3 A6 *	N100 EH3 A6 *
	250	70	132 □	N200 EHN3 A6 *	N200 EH3 A6 *	
	3-polig  	20	7,5	64 □	M10H EHN4 A3	M10H EH4 A3
		32	15	64 □	N20 EHN4 A3	N20 EH4 A3
		50	22	64 □	N33F EHN4 A3	N33F EH4 A3
	4-polig  	63	22	88 □	N40 EHN4 A3	N40 EH4 A3
		80	30	88 □	N60 EHN4 A3	N60 EH4 A3
		115	45	88 □	N80 EHN4 A3	N80 EH4 A3
		6-polig  	20	7,5	64 □	M10H EHN4 A6
	32		15	64 □	N20 EHN4 A6 *	N20 EH4 A6 *
	50		22	64 □	N33F EHN4 A6	N33F EH4 A6
	63		22	88 □	N40 EHN4 A6 *	N40 EH4 A6 *
	80		30	88 □	N60 EHN4 A6 *	N60 EH4 A6 *
		115	45	88 □	N80 EHN4 A6 *	N80 EH4 A6 *

*) Main terminal protection must be installed by user.

Switches with other switch programs, auxiliary contacts, PE-terminals on request

Main Switches for base mounting

Like main switches for panel mounting
The order number changes from
N.. E.. A. to N.. V.. A.

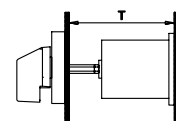

Depth **T** is necessary for order



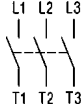

We recommend to use a **door coupling**, see page 64

Maintenance and Safety Switches, plastic enclosed on request

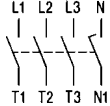
Switch Disconnectors for Panel Mounting, IP65

	AC21 690V	AC23 3x400V	plate IP65	Type	No.	Pack pcs.	Weight kg/pcs.
On-Off Switches 3-pole							
 	20A	5,5kW	48 □	LTS20 E A3		1	0,15
	25A	7,5kW	48 □	LTS25 E A3		1	0,15
	32A	11kW	48 □	LTS32 E A3		1	0,15
	40A	15kW	48 □	LTS40 E A3		1	0,15
	63A	22kW	48 □	LTS63 E A3		1	0,17
	80A	22kW	48 □	LTS80 E A3		1	0,17
	80A	30kW	64 □	LT80 E T300		1	0,40
	100A	37kW	64 □	LT100 E T300		1	0,40
	125A	45kW	88 □	LT125 E T300		1	1,10
	160A	55kW	88 □	LT160 E T300		1	1,10
On-Off Switches 4-pole							
 	20A	5,5kW	48 □	LTS20 E A4		1	0,18
	25A	7,5kW	48 □	LTS25 E A4		1	0,18
	32A	11kW	48 □	LTS32 E A4		1	0,18
	40A	15kW	48 □	LTS40 E A4		1	0,18
	63A	22kW	48 □	LTS63 E A4		1	0,21
	80A	22kW	48 □	LTS80 E A4		1	0,21
	80A	30kW	64 □	LT80 E T400		1	0,50
	100A	37kW	64 □	LT100 E T400		1	0,50
	125A	45kW	88 □	LT125 E T400		1	1,50
	160A	55kW	88 □	LT160 E T400		1	1,50
6-pole, 8-pole Changeover 3-pole, 4-pole				on request on request			

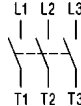
Switch Disconnectors for Distribution Boards

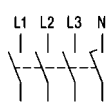
	AC21 690V	AC23 3x400V	plate IP65	Type	No.	Pack pcs.	Weight kg/pcs.	
On-Off Switches 3-pole								
 	20A	5,5kW	52x45	LTS20 SMA A3		1	0,15	
	25A	7,5kW	52x45	LTS25 SMA A3		1	0,15	
	32A	11kW	52x45	LTS30 SMA A3		1	0,15	
	40A	15kW	52x45	LTS40 SMA A3		1	0,15	
	63A	22kW	52x45	LTS63 SMA A3		1	0,17	
	80A	22kW	52x45	LTS80 SMA A3		1	0,17	
	80A	30kW	70x45	LT80 SMA T300		1	0,37	
	100A	37kW	70x45	LT100 SMA T300		1	0,37	
	On-Off Switches 4-pole							
	 	20A	5,5kW	52x45	LTS20 SMA A4		1	0,16
25A		7,5kW	52x45	LTS25 SMA A4		1	0,16	
32A		11kW	52x45	LTS32 SMA A4		1	0,16	
40A		15kW	52x45	LTS40 SMA A4		1	0,16	
63A		22kW	52x45	LTS63 SMA A4		1	0,21	
80A		22kW	52x45	LTS80 SMA A4		1	0,21	
80A		30kW	70x45	LT80 SMA T400		1	0,48	
100A		37kW	70x45	LT100 SMA T400		1	0,48	
6-pole, 8-pole Changeover 3-pole, 4-pole					on request on request			

Switch Disconnectors for Base mounting on request

Add-on modules (4th pole, aux. contacts, PE-terminal, terminal cover plates, escutcheon plates) see page 51

Switch Disconnectors in Plastic Enclosure, IP65

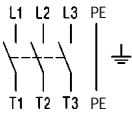
	AC21 690V	AC23 3x400V	plate IP65	Type	No.	Pack pcs.	Weight kg/pcs.
On-Off Switches 3-pole  	20A	5,5kW	48 □	LTS20 PF A3+PEN		1	0,30
	25A	7,5kW	48 □	LTS25 PF A3+PEN		1	0,30
	32A	11kW	48 □	LTS32 PF A3+PEN		1	0,30
	40A	15kW	48 □	LTS40 PF A3+PEN		1	0,30
	63A	22kW	48 □	LTS63 PF A3+PEN		1	0,58
	80A	22kW	48 □	LTS80 PF A3+PEN		1	0,58

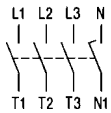
On-Off Switches 4-pole  	20A	5,5kW	48 □	LTS20 PF A4		1	0,31
	25A	7,5kW	48 □	LTS25 PF A4		1	0,31
	32A	11kW	48 □	LTS32 PF A4		1	0,31
	40A	15kW	48 □	LTS40 PF A4		1	0,31
	63A	22kW	48 □	LTS63 PF A4		1	0,62
	80A	22kW	48 □	LTS80 PF A4		1	0,62

Load Switches for resistive or slightly inductive loads or switching without load

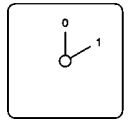
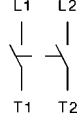
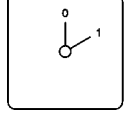
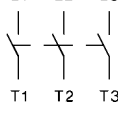
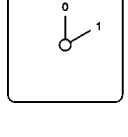
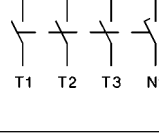
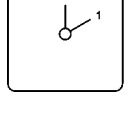
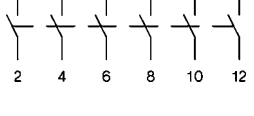
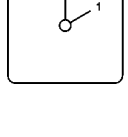
Description	Wiring diagram	Switching angle	Number of cells ↓ Size ↓ AC21	Type	Design .E. .V. ↓ ↓	Switch pro- gram	Escutcheon plate
On-Off-switches A	1-pole 	60°	2 88 □ 125A	L100 . x x	. A1		
			1 180A	L160 . x x	. A1		
			1 132 □ 400A	L400 . x x	. A1		
			3 600A	L600 . x x	. A1		
			2 800A	L800 . x x	. A1		
3 1200A	L1200 . x x	. A1					
2-pole		60°	2 88 □ 125A	L100 . x x	. A2		
			2 180A	L160 . x x	. A2		
			2 132 □ 400A	L400 . x x	. A2		
			3 600A	L600 . x x	. A2		
			2 800A	L800 . x x	. A2		
3 1200A	L1200 . x x	. A2					
3-pole		60°	4 88 □ 125A	L100 . x x	. A3		
			3 180A	L160 . x x	. A3		
			3 132 □ 400A	L400 . x x	. A3		
			6 600A	L600 . x x	. A3		
			6 800A	L800 . x x	. A3		
9 1200A	L1200 . x x	. A3					
4-pole 4. pole early make		60°	4 88 □ 125A	L100 . x x	. A4		
			4 180A	L160 . x x	. A4		
			4 132 □ 400A	L400 . x x	. A4		
			6 600A	L600 . x x	. A4		
			8 800A	L800 . x x	. A4		
12 1200A	L1200 . x x	. A4					
6-pole		60°	6 88 □ 125A	L100 . x x	. A6		
			6 180A	L160 . x x	. A6		
			6 132 □ 400A	L400 . x x	. A6		
			9 600A	L600 . x x	. A6		
			12 800A	L800 . x x	. A6		
18 1200A	L1200 . x x	. A6					

For switches with the design V.. it is necessary to state the installation depth - that is, the distance between mounting level of the switch and the inside edge of the door (dimension T).

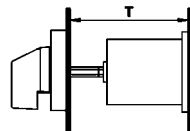

Further informations page
 Technical Data 76
 Dimensions 85

Load Switches for resistive or slightly inductive loads or switching without load

Description	Wiring diagram	Switching angle	Number of cells		Type	Design		Switch program	Escutcheon plate
			↓ Size	↓ AC21		.E.	.V.		
Changeover switches U									
1-pole		60°	2	88 □ 125A	L100 .	x	x	. U1	
			1	180A	L160 .	x	x	. U1	
			1	132 □ 400A	L400 .	x	x	. U1	
			3	600A	L600 .	x	x	. U1	
			2	800A	L800 .	x	x	. U1	
3	1200A	L1200 .	x	x	. U1				
2-pole		60°	2	88 □ 125A	L100 .	x	x	. U2	
			2	180A	L160 .	x	x	. U2	
			2	132 □ 400A	L400 .	x	x	. U2	
			3	600A	L600 .	x	x	. U2	
			4	800A	L800 .	x	x	. U2	
			6	1200A	L1200 .	x	x	. U2	
3-pole		60°	4	88 □ 125A	L100 .	x	x	. U3	
			3	180A	L160 .	x	x	. U3	
			3	132 □ 400A	L400 .	x	x	. U3	
			6	600A	L600 .	x	x	. U3	
			6	800A	L800 .	x	x	. U3	
			9	1200A	L1200 .	x	x	. U3	
4-pole 4. pole early make		60°	4	88 □ 125A	L100 .	x	x	. U4	
			4	180A	L160 .	x	x	. U4	
			4	132 □ 400A	L400 .	x	x	. U4	
			6	600A	L600 .	x	x	. U4	
			8	800A	L800 .	x	x	. U4	
			12	1200A	L1200 .	x	x	. U4	
Changeover switches without off W									
1-pole		60°	2	88 □ 125A	L100 .	x	x	. W1	
			1	180A	L160 .	x	x	. W1	
			1	132 □ 400A	L400 .	x	x	. W1	
			3	600A	L600 .	x	x	. W1	
			2	800A	L800 .	x	x	. W1	
3	1200A	L1200 .	x	x	. W1				
2-pole		60°	2	88 □ 125A	L100 .	x	x	. W2	
			2	180A	L160 .	x	x	. W2	
			2	132 □ 400A	L400 .	x	x	. W2	
			3	600A	L600 .	x	x	. W2	
			4	800A	L800 .	x	x	. W2	
			6	1200A	L1200 .	x	x	. W2	
3-pole		60°	4	88 □ 125A	L100 .	x	x	. W3	
			3	180A	L160 .	x	x	. W3	
			3	132 □ 400A	L400 .	x	x	. W3	
			6	600A	L600 .	x	x	. W3	
			6	800A	L800 .	x	x	. W3	
			9	1200A	L1200 .	x	x	. W3	
4-pole 4. pole early make		60°	4	88 □ 125A	L100 .	x	x	. W4	
			4	180A	L160 .	x	x	. W4	
			4	132 □ 400A	L400 .	x	x	. W4	
			6	600A	L600 .	x	x	. W4	
			8	800A	L800 .	x	x	. W4	
			12	1200A	L1200 .	x	x	. W4	

Ordering example: AC1 1200A panel mounting, changeover switch without off 4-pole

L1200 E W4

Operating Knobs and Handles

Types of handles

In the standard version, the switches are supplied with a black twist knob or instrument knob (M10H - N33F), except for design SMA, which has a grey toggle knob. Switches of size L, which consist of 2 or 3 switch columns, come with a black hand wheel. If required, the switch can be supplied with other knobs, which can later easily be exchanged.

All operating knobs have an insert, which sets the position of the knob in relation to the switch shaft. This insert can be mounted in 8 different positions (at intervals of 45°), causing the angle of each individual switch setting to be rotated by 45°.

In the standard version, the switch terminals are positioned left and right (except M10H). When the knob insert is turned by 90°, the lay-out of the terminals changes to top and bottom.

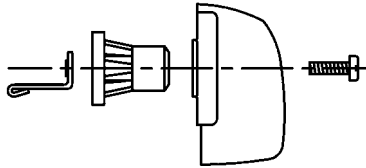

All operating knobs can be moved on the hexagonal shaft, to permit adaptation to different sheet thicknesses, etc.

Type	M10 M10H M20	N20 N33F	N40 N60 N80 L100 L160	N100 N200 L400 L600 L800 L1200
Knob movement mm	5	5	7	9
Hexagonal shaft dimension mm	5	7	9	12

Ordering example: Cam switch N60 V U3 with ball type handle red
Order type: **N60 V U3 +B3**

Dimensions see page 84



Knobs and handles Description	Colour	Ordering Code	M10 M10H M20	N20 N33F	N40 N60 N80 L100 L160	N100 N200 L400 L600 L800 L1200
Instrument knob Standard for M10 to N33F	grey black red white	+G1 +G2 +G3 +G5	X X X X	X X X X		
Twist knob Standard for N40 to N200	grey black red white yellow	+R1 +R2 +R3 +R5 +R7	X X X X	X X X X	X X X X	X X X
Toggle knob	grey black red white blue	+K1 +K2 +K3 +K5 +K6	X X X X X	X X X X		
Ball type handle	grey black red	+B1 +B2 +B3		X X X	X X X	X X X
Hand wheel	black	+HR				X

Escutcheon Plates

TELUX-Cam Switches in designs E, V, P, PF, SM, UP, Z and KE are supplied with a square escutcheon plate consisting of a black frame and plexi insert plate. The markings are printed in black are on the back of the insert plate. To protect the markings so that they remain easy to read, the back of the insert plate is lined with silver foil. In addition, rectangular plates can be provided for all switch sizes, which can fitted on all switches after mounting.

Square plate



Rectangular plate (with square plate)

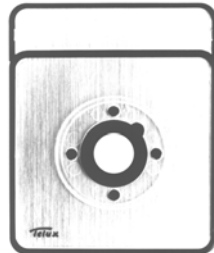

TELUX-Cam Switches in design SMA, for distribution boards with 45mm inside edge of installation cover, is supplied with a grey cover and black markings.



Special engraved markings on escutcheon plates are limited by the available space. In the case of relatively large production runs or frequent use of the text, we recommend ordering of a printing block. This will be invoiced at cost price, and the engraving will not be charged for. This investment generally pays with batches from 50 pieces upwards.

The "escutcheon plate" column of the selection and ordering tables for switch programs indicates the standard plate and, in some cases, an additional plate that is often used for the programs in question. If such a plate, listed in the selection table, is desired, the appropriate code number should be stated when ordering a switch and switch program.

Should only **plates** or **parts** of the latter be ordered, the order type is assembled as shown by the following example.

Code letter of switch sizes

M10, M10H, M20	A
N20, N33F	E
N40, N60, N80, L100, L160	H
N100, N200, L400, L600, L800, L1200	L

Ordering example: Escutcheon plate silver, complete, for cam switch M10, marked with MAN OFF AUTO, angle of rotation 60°

Order type:

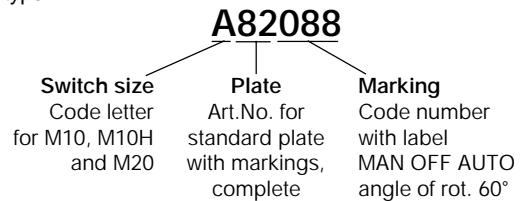

However, if a **switch** with non-standard lettering is required, only three-digit code number for the marking need be added to the order type (see next page).

Dimensions see page 86

Description	Order type		
	Switch size Code letter	Plate Art.No.	Marking Code number
Escutcheon plate for designs E, V, P., Z, SM, KE and UP Escutcheon frame black, plexi insert plate silver, markings black			
Escutcheon plate complete silver	A E H L	.82...	... (see pp. 58-60)
Escutcheon plate complete yellow	A E H L	.90...	... (see pp. 58-60)
Plexi insert plate silver	A E H L	.85...	... (see pp. 58-60)
Plexi insert plate yellow	A E H L	.80...	... (see pp. 58-60)
Escutcheon frame black	A E H L	.8203	-
Rectangular escutcheon plate for designs E, V, Z and SM Escutcheon frame black, plexi insert plate silver, markings black			
Rectangular additional escutcheon plate complete silver	A E H L	.865..	... (see pp. 58-60)
Rectangular additional escutcheon plate complete yellow	A E H L	.915..	... (see pp. 58-60)
Plexi insert plate silver	A E H L	.885..	... (see pp. 58-60)
Plexi insert plate yellow	A E H L	.895..	... (see pp. 58-60)
Escutcheon frame black	A E H L	.8503	-
Installation cover for design SMA grey cover , markings black	A - - -	.68...	... (see page 60)

Escutcheon Plates

Selected standard markings

The markings that are most commonly required are shown below, together with code letters for the switch size and the code number.

Ordering example: Switch type M10H E A3 with escutcheon plate

"OFF ON" and additional rectangular escutcheon plate "PUMP"

Order type: **M10H E A3 +003 +516**

Code letter of switch sizes

M10, M10H, M20

N20, N33F

N40, N60, N80, L100, L160

N100, N200, L400, L600, L800, L1200

A

E

H

L

Blank escutcheon plates

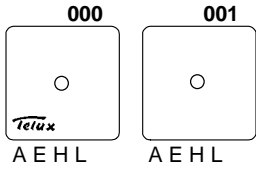

Switching angle 30°

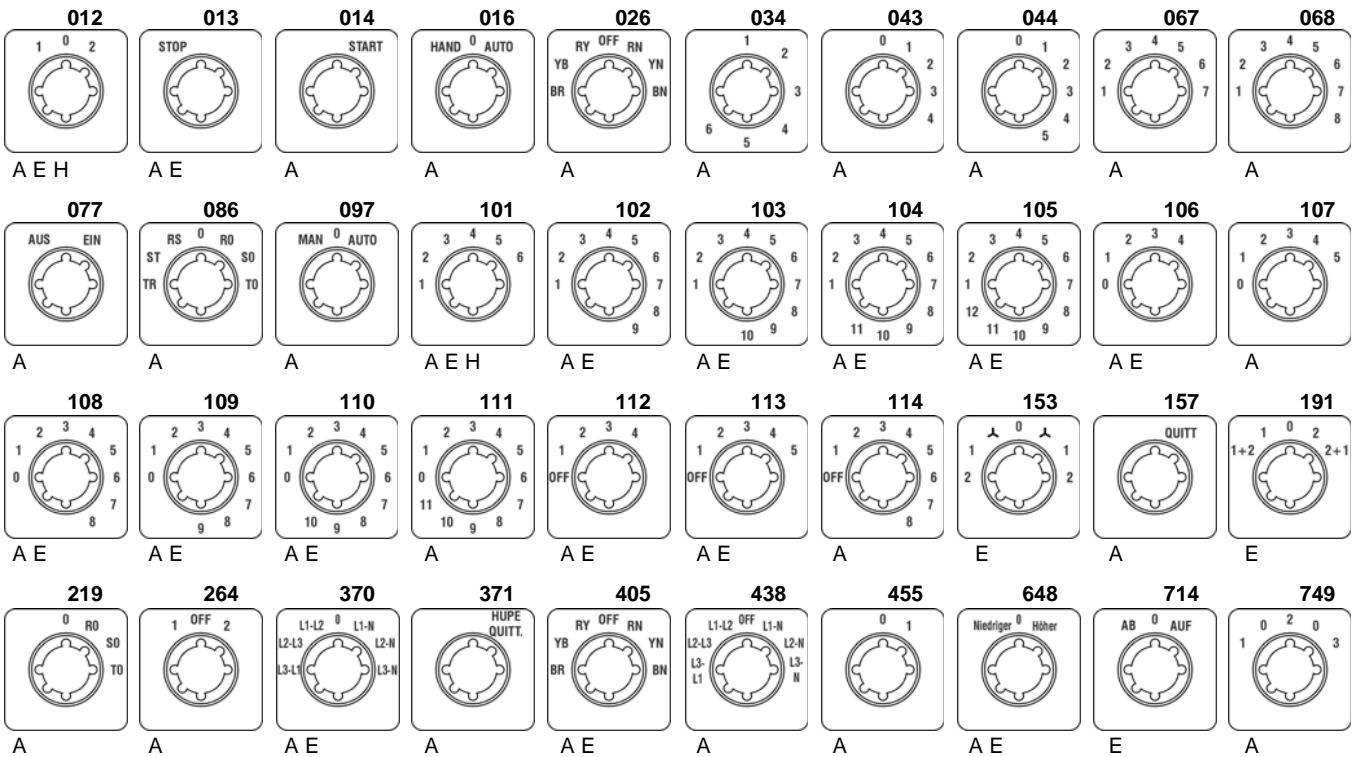

Switching angle 45°

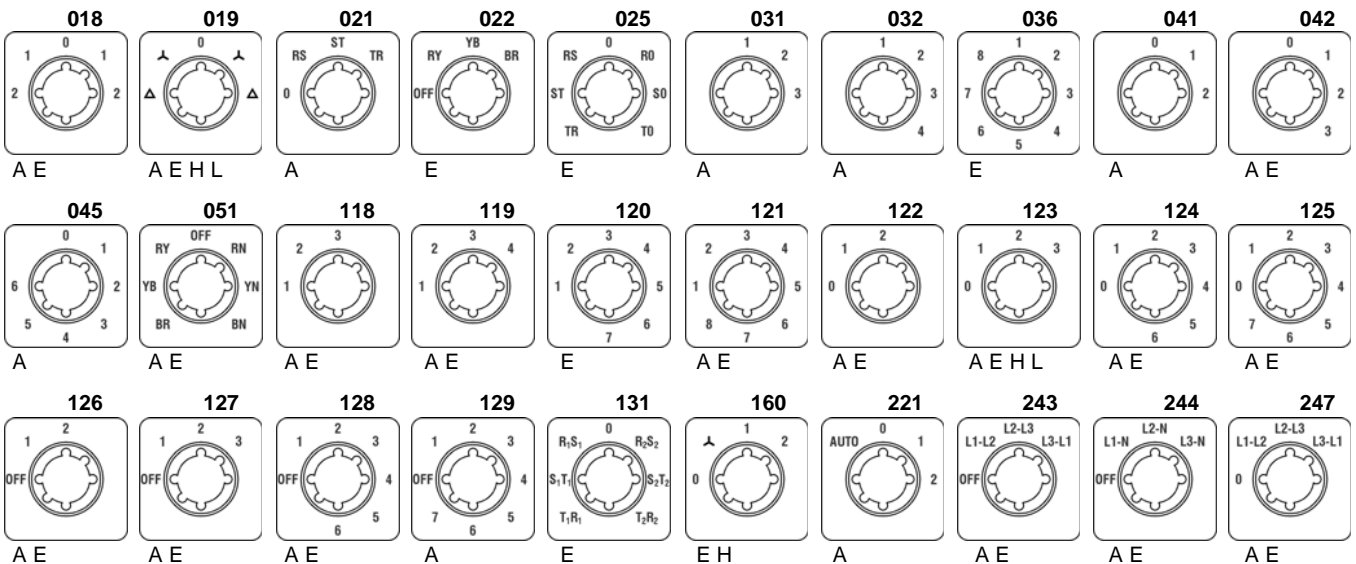

Escutcheon Plates

Switching angle 45°

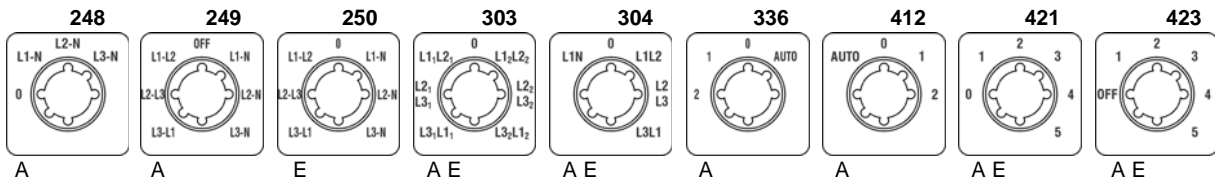

Switching angle 60°

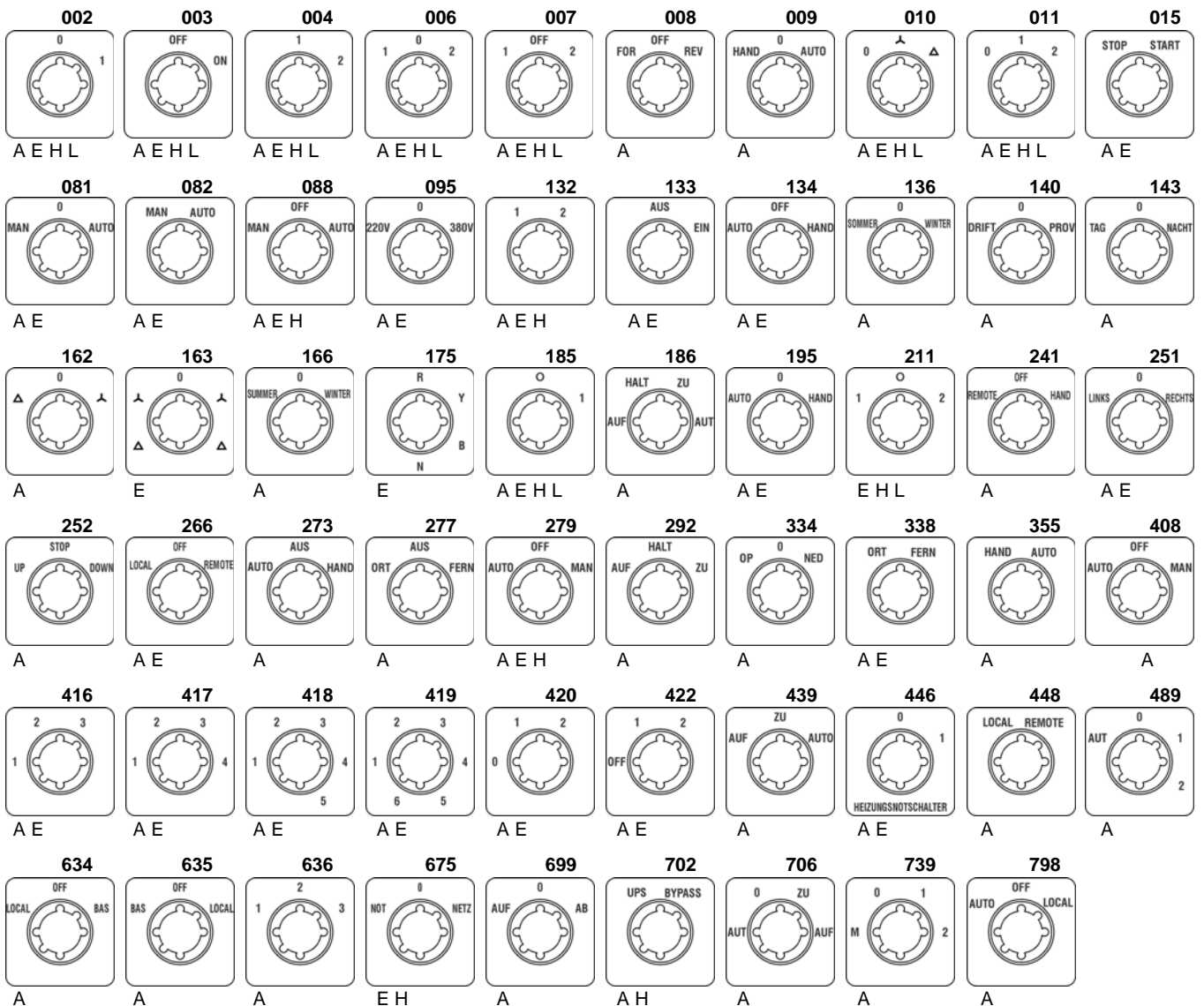

Escutcheon Plates

Switching angle 90°

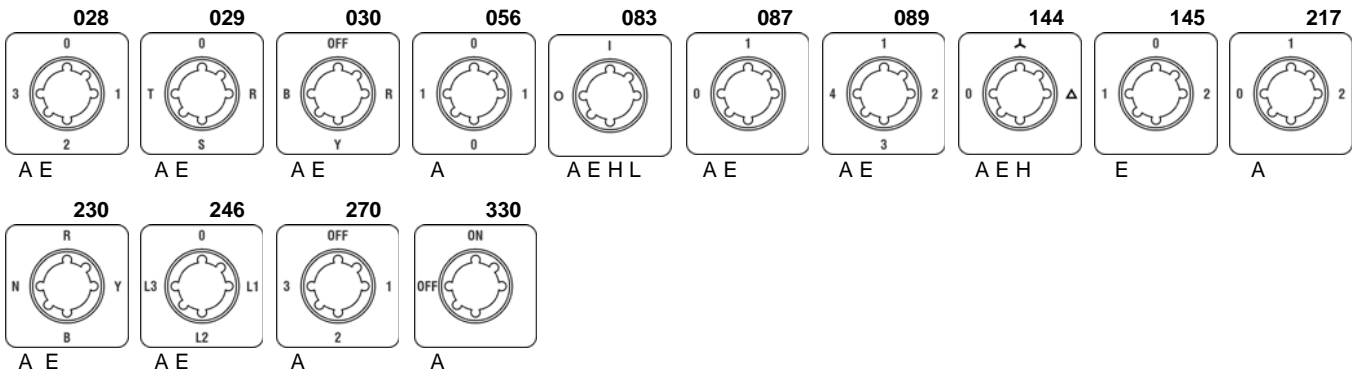

Miscellaneous

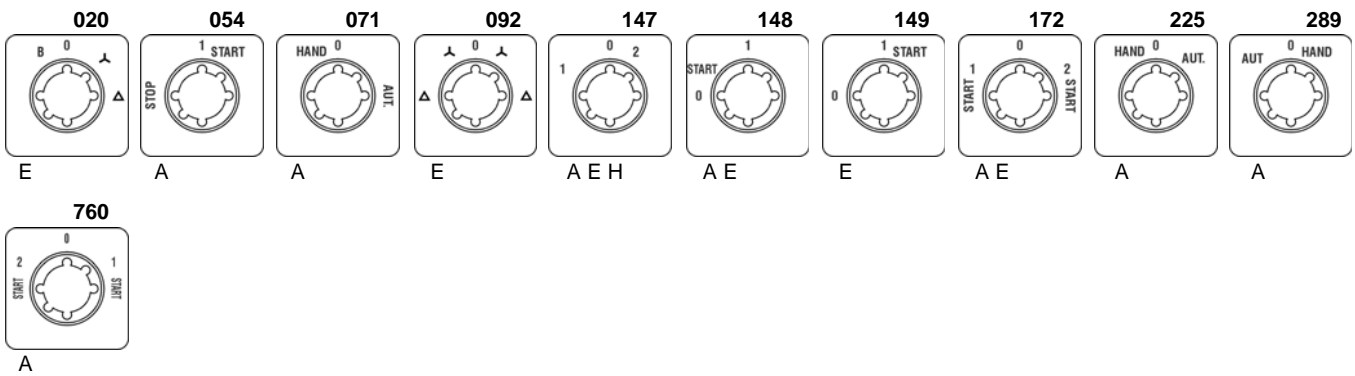

Rectangular additional escutcheon plates

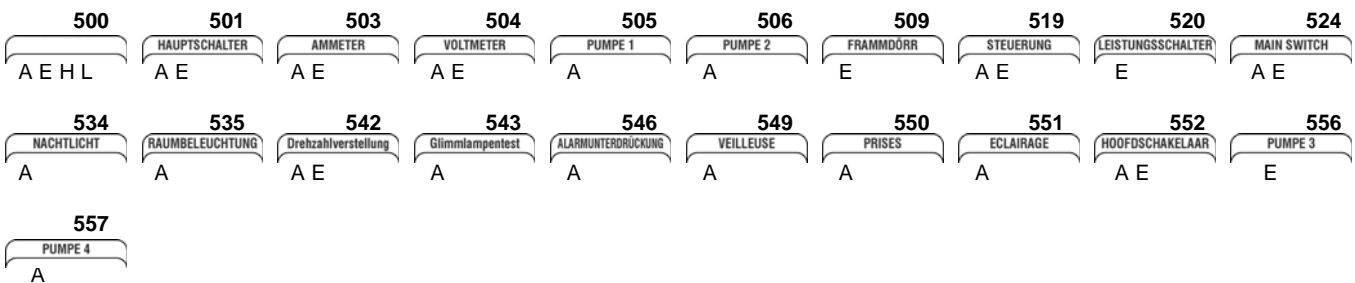

Covers for design SMA

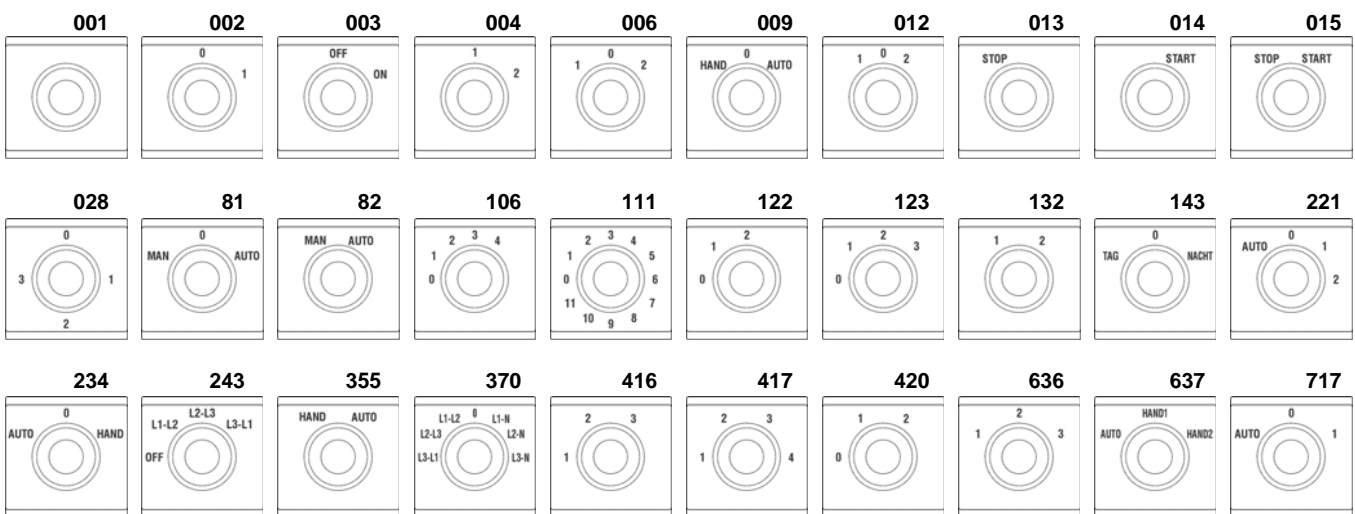

Switching angles

Arrangement of switch settings

All feasible arrangements of switch settings are shown, and defined by position numbers, in the following tables. Not only the switching angles, but also switches with latched or momentary settings, or combinations of the two, are distinguished from one another.

Knowledge of the following variations is particularly important when planning special switches. It is necessary to state the position number when ordering special switches, as the cheapest version will otherwise be selected.

All the switches types listed can be supplied with switching angles other than those indicated, provided that they are permitted by the switch program (additional charge).

Switching angle 30°

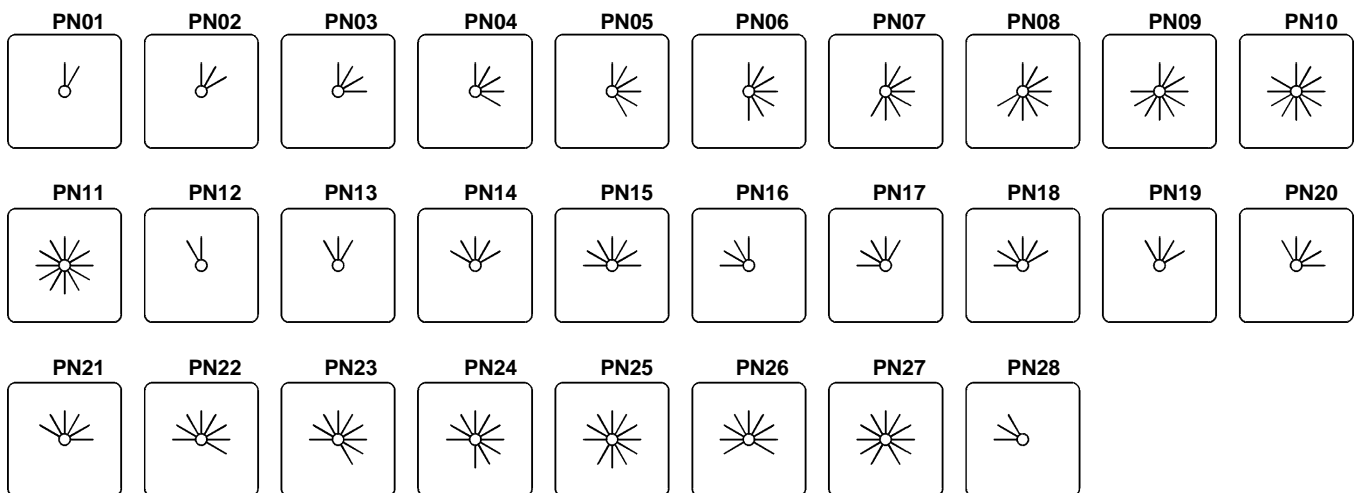

Switching angle 45°

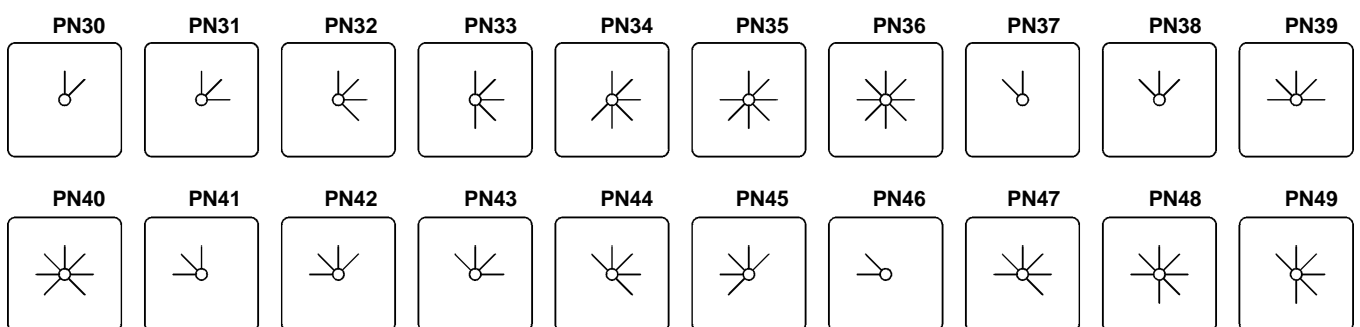

Switching angle 60°

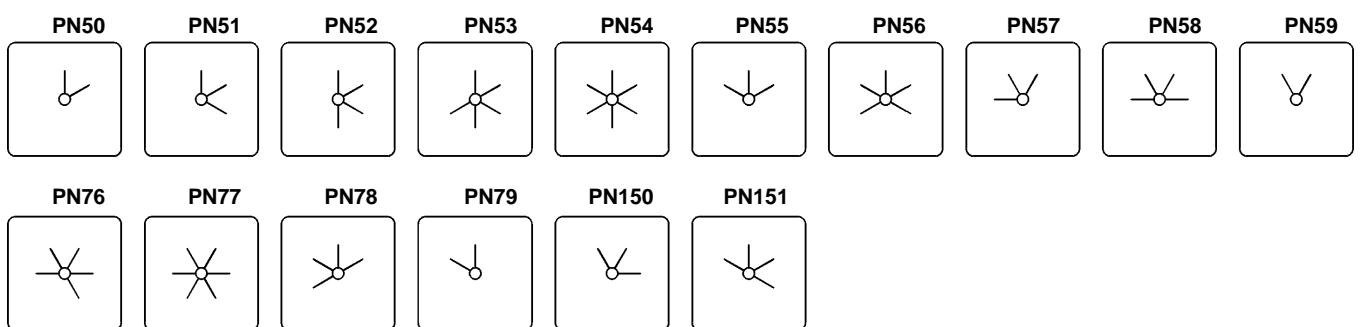

Switching angle 45/90°

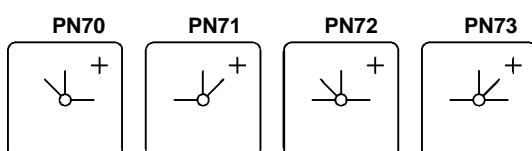

+) Not available for switch types M10, M10H and M20

Switching angles

Switching angle 90°

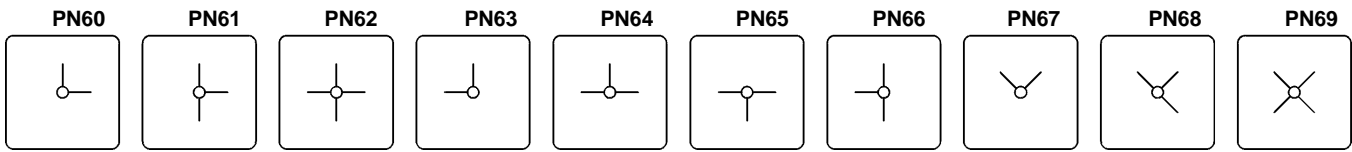

Momentary settings and special combinations

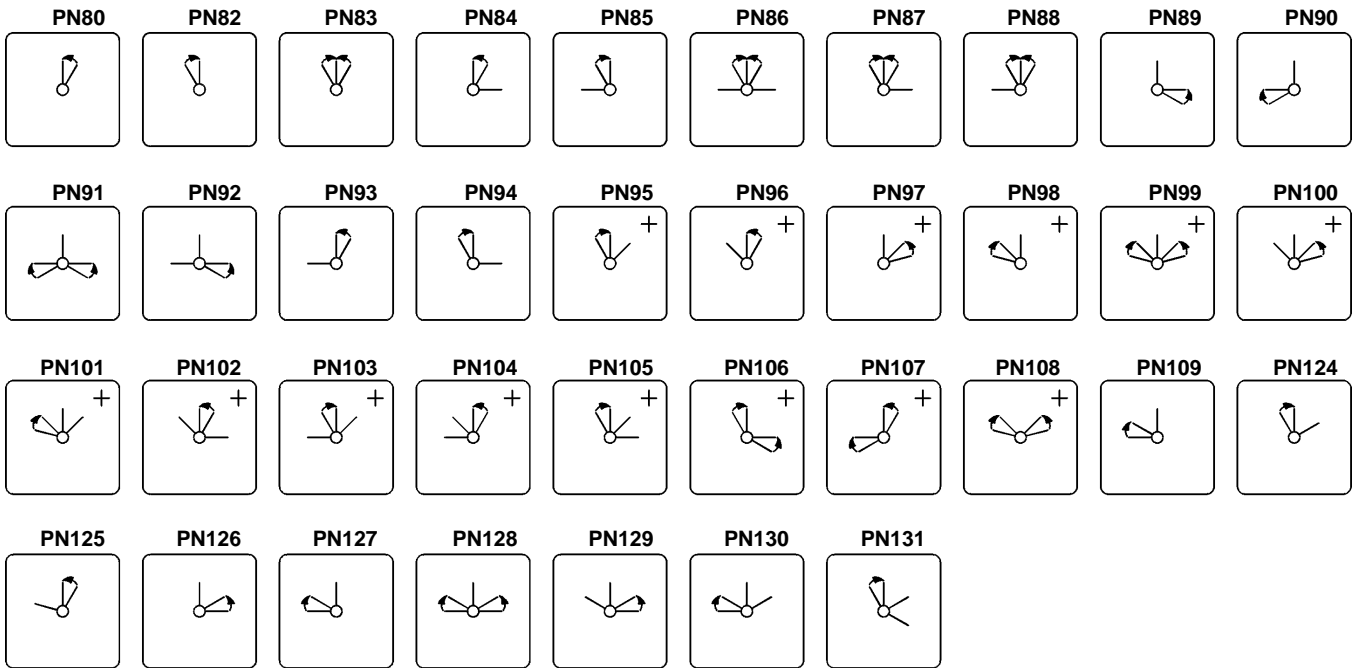

Spring return over several settings

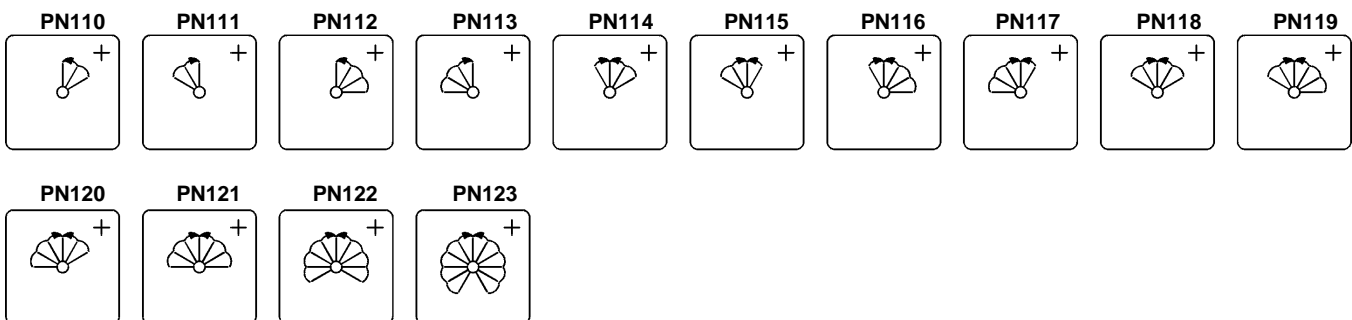

+) Not available for switch types M10, M10H and M20

Handles and drive units

Special actuating mechanisms and ancillary attachments can be provided for many switch sizes and designs. Here, the switch type is followed by order code for the ancillary attachment.

Ordering example: Cam switch N20 GF W3R for foot operation
Order type: **N20 GF W3R +FUSS1**

Dimensions see page 87



	Ordering Code	Suitable for designs	Suitable for switch type
Removable knob drive The operating knob is designed to be removable, and can be withdrawn in any setting. The switch shaft is covered when the knob is withdrawn.	+STGR	E P	M10H, M20, N20, N33F M10, N20, N33F
Removable knob drive 2 The operating knob is designed to be removable. It can be withdrawn in one setting, to be stated when ordering.	+STGR2	E P	M10H, M20, N20, N33F M10, N20, N33F
Roller arm For actuation with gates, fork levers and the like.	+RH	E, PF P G, GF	N20, N33F, N40, N60, N80 N20, N33F, N40, N60 N20, N33F ¹⁾
Roller arm 1, reinforced with reinforced bearings on the switch shaft and strong return spring.	+RHS1	G, GF	N20
Roller arm 2, reinforced the switch rotates in intervals of 30°. The switch can only operate on conjunction with the circular switching attachment (+RU) and 12 switch 30° settings	+RHS2	G, GF	N20
Eyelet lever For cable or chain actuation.	+ÖH	E, PF P G, GF	N20, N33F, N40, N60, N80 N20, N33F, N40, N60 N20, N33F ¹⁾
Double arm eyelet lever cream-col. black, red or grey available	+ÖH2	E,P,PF,G,GF	N20, N33F ¹⁾
Eyelet lever 1, reinforced with reinforced bearings on the switch shaft and strong return spring.	+ÖHS1	G, GF	N20
Eyelet lever 2, reinforced the switch rotates in intervals of 30°. The switch can only operate on conjunction with the circular switching attachment and 12 switch 30° settings.	+ÖHS2	G, GF	N20
Footswitch drive unit Single-arm footswitch with strong return spring.	+FUSS1	G, GF	N20
Stepswitch drive unit When the footswitch is depressed, the switch rotates in intervals of 30°. The stepswitch can only operate on conjunction with the circular switching attachment (attachment +RU) and 12 switch 30° settings (1 rotation).	+FUSS2	G, GF	N20
Double arm Footswitch Switching angle: 2 x 60° or 3 x 30° without spring return.	+FUSS3	G, GF	N20

1) Cast enclosed switches are delivered with switch type N32

Door couplings

For switches with door couplings it is necessary to state the installation depth - that is, the distance between mounting level of the switch and the inside edge of the door (dimension T).

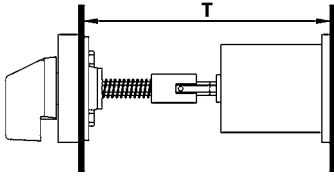

Door couplings are available for switches to be installed in switchgear cabinets or distribution boards with hinged doors. These permit the doors to be opened without removal of the operating knobs.

Ordering example: Cam switch N100 V A3 with lockable door coupling, moisture protected IP65, dimension T=580mm
Order type: **N100 V A3 +TK2FR/580**

Dimensions see page 88



	Ordering Code	Suitable for designs	Suitable for switch type
Door coupling Protection class from front: IP65 5-hole mounting	+TKE/...	V, SM	M10H, M20, N20, N33F
Door coupling locked Protection class from front: IP65 5-hole mounting Doors only open at a given switch setting: unless otherwise stated, the "OFF" setting.	+TK2E/...	V, SM	M10H, M20, N20, N33F
Door coupling locked Protection class from front: IP65 Central fixing Ø22mm Doors only open at a given switch setting: unless otherwise stated, the "OFF" setting.	+TK2Z/...	V, SM	M10H, M20, N20, N33F
Door coupling Protection class from front: IP40 5-hole mounting	+TK/...	V	N40, N60, N80, N100, N200 L100, L160, L400, L600 L800
Door coupling Protection class from front: IP65 5-hole mounting	+TKFR/...	V	N40, N60, N80, N100, N200 L100, L160, L400, L600 L800
Door coupling locked Protection class from front: IP40 5-hole mounting Doors only open at a given switch setting: unless otherwise stated, the "OFF" setting.	+TK2/...	V	N40, N60, N80, N100, N200 L100, L160, L400, L600 L800
Door coupling locked Protection class from front: IP65 5-hole mounting Doors only open at a given switch setting: unless otherwise stated, the "OFF" setting.	+TK2FR/...	V	N40, N60, N80, N100, N200 L100, L160, L400, L600 L800

Lockable switches

Key-operated and lockable switches are supplied with two keys. Additional keys or other types of lock on request.

Ordering example: Cam switch N20 E A3 key operated
Order type: **N20 E A3 +SA**

Dimensions see page 89 and 90



	Ordering Code	Suitable for designs	Suitable for switch type
<p>Key operated switch Lock Willenhal FT101, key removable in all lockable settings. Other types of lock on request. Maximum number of cells M10 - N33F: 6 N40, N60: 2</p> <p>Key operated switch, key removable only in some settings. Add letter of setting where key is removable to ordering code according to the scetch below.</p>	<p>+SA</p> <p>+SA/.</p>	<p>E, V, SM E, V P SMA UP</p>	<p>M10H, M20, N20, N33F N40, N60 M10, N20, N33F, N40, N60 M10H, M20 M10</p>
<p>Key operated switch IP65 Lock Ronis R455, key removable in all lockable settings. Key operated switch, key removable only in some settings. Add letter of setting where key is removable to ordering code according to the scetch above.</p>	<p>+SA</p> <p>+SA/.</p>	<p>Z, ZO</p>	<p>M10H, M20</p>
<p>Key operated switch Lock KABA8, key removable in all lockable settings. Key operated switch, key removable only in some settings. Add letter of setting where key is removable to ordering code according to the scetch below.</p>	<p>+SAK</p> <p>+SAK/.</p>	<p>E</p>	<p>M10H, M20</p>
<p>Key operated switch with barrel for special security functions Lock EVVA EHZ50/5 Nickel matt Special version which prevents not only switching but also access to the cable ends and removal of the switch when locked. Maximum number of cells Design E, P: 4 Design UP : 3</p>	<p>+SASI</p>	<p>E P UP</p>	<p>M10H, M20 M10, M20 M10, M20</p>
<p>Key operated switch for special security functions without lock for use of lock EVVA EHZ50/5 or with same dimensions Maximum number of cells Design E, P: 4 Design UP : 3</p>	<p>+SASO</p>	<p>E P UP</p>	<p>M10H, M20 M10, M20 M10, M20</p>

Padlock devices

A range of padlock devices designed to prevent from being turned on by unauthorized personnel, or during maintenance and repair work, can be supplied.

Dimensions see page 91

Ordering example: Cam switch N33F E A3 with interlocking device SV3 suitable for 3 padlocks
Order type: **N33F E A3 +SV3**

	Padlock device Description	Ordering Code	Suitable for designs	Suitable for switch type
	Padlock device Standard version black , otherwise red , for 1 or 2 padlocks. Shackles up to Ø6mm Standard version black 64 x 64mm, otherwise red 64 x 64mm	+SV1 +SV1R +SV164 +SV164R	E, V, SM P, PF E, V P, PF	M10H, M20 M10 M10H, N20, N33F N20, N33F
	Padlock device Standard version black , otherwise yellow insert plate and red twist knob for 1-3 padlocks. Shackles up to Ø8,5mm Prior to insertion of the first padlock, a red locking ledge must be depressed. This indicates that the switch is locked.	+SV3 +SV3R	E, V E, V E, V PF	N40, N60, N80, L100, L160 N100, N200, L400, L600, L800, L1200 N40, N60, N80, N100, N200
	Padlock device Standard base grey , locking ring black , or with yellow base and red locking ring. Locking ring for 1-3 padlocks. Shackles up to Ø6mm Standard base grey , locking ring black 88 x 88mm, or with yellow base and red locking ring 88 x 88mm	+SV4 +SV4R +SV488 +SV488R	E, V SM P, PF E, V E, V P, PF	M10H, N20, N33F M10H, N20, N33F N20, N33F M10H, N20, N33F N40, N60, N80 N40, N60, N80
	Key lock device With a cylinder lock in the lock attachment, one or more switch settings are lockable (state when ordering). The operating knob can only be turned when unlocked. The key can be withdrawn wheter locked or unlocked. Special versions, in which the key cannot be withdrawn when in some (unlockable) settings can be supplied.	+SZ	E, V SM	alle M10H, M20, N20, N33F
	Key lock device Special version for on-off switches, in which it is possible to switch off without a key.	+SZ2	E, V SM	alle M10H, M20, N20, N33F

Switch interlocks

A wide range of locks and interlocking devices, designed to prevent accidental or hazardous switching, can be supplied.

Ordering example: Cam switch N20 E A3 with push button switch lock
Order type: **N20 E A3 +DV**

Dimensions see page 92

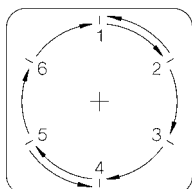
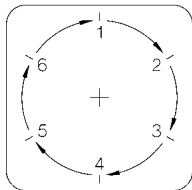
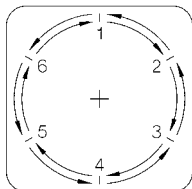

Description	Ordering Code	Suitable for designs	Suitable for switch type
Push button interlock The switch can only be actuated when the pushbutton is simultaneously depressed (two-handed operation).	+DV	E, V	all
Interlock with electrical contact The switch can only be actuated when the pushbutton, which also operates a make and break contact, is actuated (for external interlocking devices or safety measures).	+ET	E, V	all
Magnetic interlock The switch can only be actuated when an electromagnet is simultaneously excited. When ordering, voltage and percentage duty cycle of the magnet coil should be stated.	+MV	E	N20, N33F, N40, N60, N80, N100, N200
Mutual interlock Two or more switches, mounted on the same front plate, can be mutually interlocked, such that one switch can only be actuated when the other is in given settings.	+GV	E, V	N20, N33F, N40, N60, N80, N100, N200
Circular switch Switches that have the maximum number of settings for a given switching angle can be made without a stop position, permitting direct switching from the last to the first setting.	+RU	all	all
Backswitch 1 Special version of the circular switch, in which the switch can only be turned in one direction.	+RS1	all	all
Backswitch 2 Special version of the circular switch, in which, in given positions, the switch can only be operated in one direction.	+RS2	all	all

Couplings and stop mechanism

A range of couplings and stop mechanisms for trouble-free operation of switches with a very large number of contacts can be supplied.
Dimension see page 93

Ordering example: Cam switch N200 V ST0113 spread over three columns interconnected by gears
 Order type: **N200 V ST0113 +ZK3**



Description	Ordering Code	Suitable for designs	Suitable for switch type
Coupling of two columns For simultaneous drive of two switch columns (with very large number of switch cells or limited installation depth).	+ZK2	E, V	all
Coupling of three columns For simultaneous drive of three switch columns.	+ZK3	E, V	all
Coupling of different switch sizes For attachment of control switches (auxiliary contacts) to larger switches. M10H, M20 in sizes E and H. N20 to N80 in size L.	+ZWK	E	N40, N60, N80, L100, L160 N100, N200, L400, L600, L800, L1200
Delayed action switch Using a delayed action coupling, two switch shafts - a main shaft and delayed shaft - can be coupled, such that the delayed shaft is rotated together with the main shaft once a given angle of rotation is reached (e.g. for off-load return of switches used with pole-changing motors).	+SK	E, V G, GF	N20, N33F, N40, N60, N80 N20, N32
Second stop mechanism With switches in which a large number of contacts is simultaneously operated, use of a second stop mechanism is sometimes necessary, in order to ensure precise switching to the next setting.	+RW2	all	all
Metal stop mechanism for extreme mechanical stress on the stop mechanism, e.g. where many contacts are switched at the same time. Not for PN110 to PN123	+MRW	E, V E, V E, V G, GF	N40, N60, N80, L100, L160 N100, N200, L400, L600, L800, L1200 N20, N32

Special versions

A number of special versions can be supplied for adaptation of switches to various conditions of use.

Ordering example: Cam switch M10H E U3 with pilot light for 230V
Order type: **M10H E U3 +GFP +SL/230**

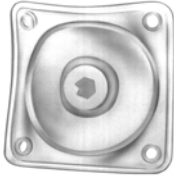

Description	Ordering Code	Suitable for designs	Suitable for switch type
Switch shaft sealing For increased front protection class on IP54.	+WD	E, V SM	N20 to L1200 N20, N33F
Front plate/switch shaft sealing For increased front protection class on IP65. In this version, a wider hole is required for the shaft. Dimensions see page 89	+FPWD	E, V, SM	N20, N33F
Extended switch shaft For adaptation of switch designs V and SM to the enclosure depth. State additional shaft length when ordering.	+VW/...	E, V SM	all M10H, M20, N20, N33F
Large front plate Switch with front plate and operating knob of the next size (for replacement of older, larger switches or aesthetic reasons).	+GFP	E, V, SM	M10H, N20, N33F
Large front plate + stop mechanism Switch with front plate, stop mechanism and operating knob of the next size	+GFPR	E, V, SM	M10H, N20, N33F
Switch with pilot lamp lamp red, 230V lamp red, 400V lamp green, 230V lamp green, 400V	+SLR/230 +SLR/400 +SLG/230 +SLG/400	E P UP	all M10, N20, N33F, N40, N60 M10, N20
Gold plated contacts For electronic circuits with low voltages and currents.	+GK	all	M10H, M20, N20, N33F
Tropical proof type	+TR	all	all
Neon safety switch For all-pole switching off of neon advertisement circuits by the Fire Brigade. Dimensions see page 91	+FEU	E	N20, N33F
Door switch Two-pole switch for circuit breaking when doors to electrical operating areas are opened. $I_{th} = 20A, U_e = 415V$ Dimensions see page 91	BK	-	-

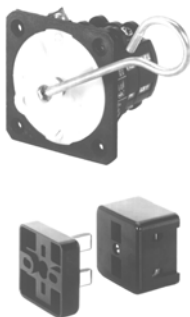

Accessories

A number of special versions can be supplied for adaptation of switches to various conditions of use.
Dimensions see page 92

Ordering example: Cam switch N20 E A3 with terminal cover plate
 Order type: **N20 E A3 +KLAD**

Description	Ordering Code	Suitable for designs	Suitable for switch type
Terminal cover plate Prevents accidental touching of live terminals (requirement for main switches according to VDE 0113) only for 2 cells for all cells	+KLAD	E, V	N20, N40, N60, N80 N100, N200
	+KLAD	E, V	N33F
Moisture proofing caps Protection class from rear: IP54. For protection of the switch from dust and moisture (e.g. when installed in machine pedestals). For switch mounting from the front and rear. Conical cable entry glands. Maximum number of cells: M10H 7 N20 5 N40 4 N60 2	+FR	E	M10H, N20, N40, N60
 Angled terminals For easy connection of inaccessible switches. Unless otherwise stated, all terminals specified with markings are equipped in this manner. A distinction is drawn between left and right angled terminals. Seen from the switch end, the left terminals are located above left and below right; conversely, right terminals are above right and below left.	+WK	E, V	M20, N20, N40, N60, N80, N100
	Fast-on connectors For 6,3 x 0,8mm plugs.	+AMPZ	E, V
Earth terminals 2 terminals, connected with one another, insulated from switch column: for earth conductors.	+PE	E, V, P, PF PF G, GF	all M10, N20, N33F, N40, N60 N80, N100, N200 N20, N32
Additional rectangular escutcheon plate 1 line Dimensions see page 84	SRE	E, Z, V, SM	all
Big additional rectangular escutcheon plate for 2 lines Dimensions see page 84	SRE2	E, V	M10H, M20, N20, N33F
Spare key for key operated switches with Lock Willenhal FT101	J7101	E, V, P SMA	M10H, M20, N20, N33F, N40 M10H, M20
Spare key for key operated switches with Lock Ronis R455	B4-R455	Z, ZO	M10H, M20
Wrench for switches with central fixing	J7049	Z, ZO	M10H, M20

Switching Programs to Customer Requirements

As a result of their modular construction, TELUX cam switches are particularly suitable for manufacturing of special variants. According to its function, each pair of contacts in the switch is adapted to the desired program by appropriate design of the cam plate. In the case of switches with an overall switching angle of more than 180°, provision must be made for a cam plate in each switching cell, controlling two opposite, independent contact pairs with matching programs (does not apply to M10, M10H, M20 and N20).

Depending on the desired contact program for the special switch, it may often be impossible to make full use of all switching cells, that is, to include the maximum possible number of contacts. In determining the number of cells or switch length, one-contact cells will sometimes be resorted to.

Switch sizes M10, M10H, M20 and N20 are exceptions to this rule. Here, two cam plates can be built into each cell, so that both contacts are independently controlled (full use of the cells with special programs).

In all special switches with overall switching angles of less than 180°, the number of cells required is calculated by having the total number of contacts in the switching program.

When planning for switches with special programs, choice of the optimum switching angle thus plays an important part. The listing of all the options for lay-out of switch settings, on pages 59 and 60, should be an aid to planning (position numbers PN).

If special markings are to be engraved on the escutcheon plates, it is vital to take account of the available space. It is advisable to use abbreviations.

We provide forms (see final page) on request, free of charge, to give a clear overview when special programs are being defined. Switch size, design, type of operating knob and desired switching angle, as well as the function of the contacts, are entered on these forms. Provision has also been made in them for entry of details as to escutcheon plate engravings or other special requirements.

Ordering Example

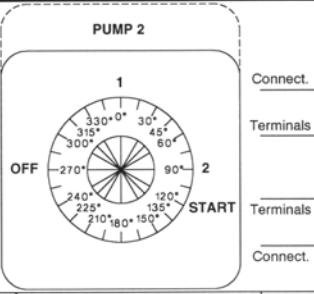
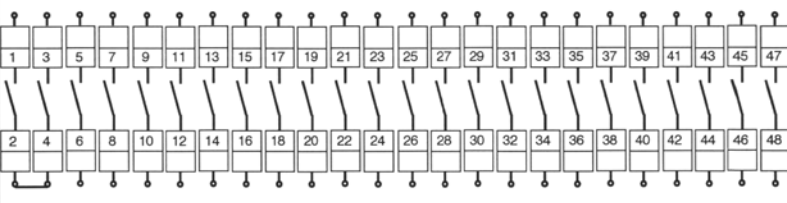









Order sheet D399E		Cam switches with special switching program		Customer:	
Switch Type		Benedikt GmbH			
M4H		A-1220 Vienna, Liebgasse 7			
M10		Phone: 251 51-0 Fax: 251 51-88			
M10H	<input checked="" type="checkbox"/>	Explanations:		Handles	
M20		Contact closed over <input checked="" type="checkbox"/>		Twist knob R (standard) black (standard) <input checked="" type="checkbox"/>	
N20		several positions <input checked="" type="checkbox"/>		Instrument knob G (standard M4H) red <input checked="" type="checkbox"/>	
N33F	L100	Spring return from pos. <input type="checkbox"/>		Toggle knob K (standard SMA) grey (standard SMA)	
N40	L160			Pointer knob Z white	
N60	L400			Ball type handle B cream-coloured	
N80	L600			Lever handle H yellow	
N100	L800			Hand wheel HR blue	
N200	L1200				
Design					
Panel mounting E	<input checked="" type="checkbox"/>	Marking for switch position		Degree	
Central fixing Z	<input checked="" type="checkbox"/>	OFF		270	
ZO		1		0	
Base mounting V		2		45	
Snap-on mount.SM		START		90	
SMA				120	
Plastic enclosure P					
IP54	PF				
Cast enclosure G					
IP54	GF				
Optional extras					
Circular switch					
Key removeable					



Order sheet A4 see last page

Technical Data

Benedikt & Jäger-Low voltage switchgear are built and tested decisive national and international specifications. All devices suit all important specifications without any test obligation, like VDE 0660, BS 5419 and also relative to IEC-recommendations.

That is the reason why Benedikt & Jäger-Low voltage switchgear are used all over the world. In order to provide special versions are sometimes limitations to the max. voltages, currents and power ratings or special markings necessary.

Country	Canada	USA	Switzerland	Denmark	Norway	Sweden	Finland	Poland	Slowakia	Czech	Hungary
State deputy or private examination (state admitted)	CSA UL	UL	SEV	DEMKO	NEMKO	SEMKO	SETI	SEP	SKTC	EZU	MEEI
Label marking of examination boards	 1)										
Duty of approbation	All switchgear	 or  Approbation of switchgear commendable	No duty of approbation since 1. 1. 1994 Our devices are according to the harmonised European Standards e.g. EN 60947 (IEC 947, VDE 0660) and can be used generally					All switchgear	All switchgear	All switchgear	All switchgear
Specification	UL is authorised for approbations acc. to Canadian Standards		Marking with approbation label is no longer necessary								

1) CSA-approbations will be removed by UL-approbations valid for USA and Canada. On and after 1. 1. 2000 switchgear will be marked with the combined UL-mark  or  only.

Utilization Categories

For easier choice of devices and in order to make the comparison of different products simpler are utilization categories for cam switches according to IEC 947-3, VDE 0660 Part 107 and auxiliary contacts

according to IEC 947-5-1 and VDE 0660 Part 200 determined. The Table below offers diverse utilization categories and assorted test conditions.

Kind of current	Category		Typical applications	Rated operational current	Test conditions for the number of on-load operating cycles (normal service)						Test conditions for making and breaking capacities (operation in fault case)							
	fre-quent operation	infre-quent operation			Make I/le	U/le	cosφ	Break Ic/le	Ur/le	cosφ	Make I/le	U/le	cosφ	Break Ic/le	Ur/le	cosφ		
Alternating Current	AC20A	AC20B	No-load conditions	all values	-	-	-	-	-	-	-	-	-	-	-	-	-	
	AC21A	AC21B	Switching of resistive loads including moderate overloads	all values	1	1	0,95	1	1	0,95	1,5	1,05	0,95	1,5	1,05	0,95		
	AC22A	AC22B	Switching of mixed resistive and inductive loads including moderate overloads	all values	1	1	0,8	1	1	0,8	3	1,05	0,65	3	1,05	0,65		
	AC23A	AC23B	Switching of motor loads or other highly inductive loads	0 < le ≤ 100A all values 100A < le	1	1	0,65	1	1	0,65	10	1,05	0,45	8	1,05	0,45		
	AC2		Slip-ring motors: Starting, plugging	all values	2,5	1	0,65	2,5	1	0,65	4	1,05	0,65	4	1,05	0,65		
	AC3		Squirrel-cage motors: Starting, switching off motors during running	0 < le ≤ 100A all values 100A < le	le ≤ 17A 6 1 le > 17A	0,65	le ≤ 17A 1 0,17 le > 17A	0,65	0,35	0,35	10	1,05	0,45	8	1,05	0,35		
	AC4		Squirrel-cage motors: Starting, plugging, inching	0 < le ≤ 100A all values 100A < le	le ≤ 17A 6 1 le > 17A	0,65	le ≤ 17A 6 1 le > 17A	0,65	0,35	0,35	12	1,05	0,45	10	1,05	0,35		
	AC15		Control of electromagnetic loads (> 72VA)	-	10	1	0,7	1	1	0,4	10	1,1	0,3	10	1,1	0,3		
Direct current	DC20A	DC20B	No-load conditions	all values	-	-	-	-	-	-	-	-	-	-	-	-	-	
	DC21A	DC21B	Switching of resistive loads including moderate overloads	all values	1	1	1	1	1	1	1,5	1,05	1	1,5	1,05	1		
	DC22A	DC22B	Switching of mixed resistive a. induct. loads incl. moderate overloads (shunt motors)	all values	1	1	2	1	1	2	4	1,05	2,5	4	1,05	2,5		
	DC23A	DC23B	Switching of highly inductive loads (e.g. series motors)	all values	1	1	7,5	1	1	7,5	4	1,05	15	4	1,05	15		
	DC3		Shunt-motors: Starting, plugging, inching	all values	2,5	1	2	2,5	1	2	4	1,05	2,5	4	1,05	2,5		
	DC5		Series-motors: Starting, plugging, inching	all values	2,5	1	7,5	2,5	1	7,5	4	1,05	15	4	1,05	15		

U_e Rated operational voltage, U Voltage before make, U_r Recovery voltage, I_e Rated operational current, I Current made, I_c Current broken

1) Time in milliseconds (ms)

Note:
By plugging, is understood stopping or reversing the motor rapidly by reversing motor primary connections while the motor is running.
By inching (jogging), is understood energizing a motor once or repeatedly for short periods to obtain small movements of the driven mechanism.

Technical Data

Data according to IEC 947-3, IEC 947-5-1, VDE 0660, EN 60947-3, EN 60947-5-1

Type	M10 P	M10H	M20	N20	N32 G	N33F	N40	N60	N80	N100	N200	
Rated therm. current I_{th} open A	20	20	32	32	40	50	63	85	115	150	250	
Rated therm. current I_{the} encl. A	20	20	32	32	40	50	63	85	115	150	250	
Rated operational voltage U_e V	440	690 ¹⁾	690 ¹⁾	690 ¹⁾	690 ¹⁾	690 ¹⁾	690 ¹⁾	690 ¹⁾	690 ¹⁾	690 ¹⁾	690 ¹⁾	
Disconnection property ²⁾ acc. to VDE, IEC up to V	440	440	440	440	440	440	690	440	440	690	690	
Breaking capacity I_{eff}												
3 x 220-440V A	160	160	220	220	260	260	380	520	740	900	1100	
3 x 500V A	-	100	160	160	200	200	290	380	560	680	850	
3 x 660-690V A	-	80	120	120	150	150	200	290	520	450	-	
Utilization categ. AC21A, AC21B Switching of resistive loads including moderate overloads												
Rated operational current I_e A	20	20	32	32	40	50	63	85	115	150	250	
Utilization categ. AC23A, AC23B Switching of motor loads or other highly inductive loads												
Rated current I_e 400V A	16	16	30	30	30	45	45	60	85	105	135	
Power rating 220-240V kW	4	4	7,5	7,5	7,5	11	15	22	30	40	40	
3-phase 3-pole 380-440V kW	7,5	7,5	15	15	15	22	22	30	45	55	70	
500V kW	-	7,5	15	15	15	22	22	30	45	55	70	
660-690V kW	-	7,5	15	15	15	22	18,5	30	45	45	-	
Star-Delta-Switches for squirrel cage motors												
Power rating 220-240V kW	3,7	3,7	7,5	7,5	7,5	8	11	15	18,5	37	40	
3-phase 3-pole 380-415V kW	7,5	7,5	15	15	15	18,5	18,5	25	30	40	70	
Utilization category AC3 Switching of three-phase motors												
Rated current I_e 400V A	12	12	22	22	22	30	30	50	60	80	135	
Power rating 220-240V kW	3	3	5,5	5,5	5,5	7,5	7,5	15	18,5	37	40	
3-phase 3-pole 380-440V kW	5,5	5,5	11	11	11	15	15	25	30	40	70	
500V kW	-	5,5	11	11	13	15	15	25	30	40	70	
660-690V kW	-	5,5	11	11	13	15	15	25	30	40	-	
Utilization category AC4 squirrel cage motors, inching												
Power rating 220-240V kW	0,55	0,55	2,2	2,2	3	3,7	4	5,5	6	11	18,5	
3-phase 3-pole 380-440V kW	1,5	1,5	4	4	5,5	5,5	7,5	11	15	18,5	35	
500V kW	-	1,5	4	4	5,5	5,5	7,5	11	15	22	35	
660-690V kW	-	1,5	4	4	5,5	5,5	7,5	11	15	22	-	
Utilization category AC15 Control of electromagnetic loads, contactors,												
Rated current I_e up to 240V A	6	6	12	12	16	16	-	-	-	-	-	
380-440V A	4	4	6	6	7	7	-	-	-	-	-	
2-pole in series 500V A	-	5	8	8	10	10	-	-	-	-	-	
Utilization categ. DC21A, DC21B Switching of resistive loads Time constant $L/R \leq 1ms$												
Rated current I_e 1-pole 30V A	20	20	32	32	40	40	63	80	100	150	250	
60V A	4	4	6	6	20	20	30	30	30	-	-	
110V A	0,6	0,6	3	3	4	4	6	6	6	-	-	
220V A	0,3	0,3	0,8	0,8	0,8	0,8	1,3	1,3	1,3	2,5	2,5	
440V A	-	-	0,4	0,4	0,4	0,4	0,6	0,6	0,6	0,7	0,7	
Utilization category DC3 - DC5 Switching of shunt motors and series motors Time constant $L/R \leq 15ms$												
Rated current I_e 1-pole 30V A	8	8	13	13	16	16	25	32	40	60	100	
60V A	1	1	2,4	2,4	4	4	12	12	12	-	-	
110V A	0,3	0,3	0,5	0,5	1,6	1,6	2,4	2,4	2,4	-	-	
Protection class of terminals	IP00	IP20	IP00	IP00	-	IP20	IP00	IP00	IP00	IP00	IP00	

1) suitable for: earthed-neutral systems, overvoltage category I to III, pollution degree 3 (standard-industry); $U_{imp} = 6kV$. Data for other conditions on request

2) valid for lines with grounded common neutral termination, overvoltage category III, pollution degree 3.

Technical Data

Data according to IEC 947-3, IEC 947-5-1, VDE 0660, EN 60947-3, EN 60947-5-1

Type		M10 P	M10H	M20	N20	N32 G	N33F	N40	N60	N80	N100	N200
Cable cross-sections												
solid	mm ²	1-2,5	1-2,5 ¹⁾	1,5-6	1,5-6	2,5-10	2,5-10	2,5-16 ¹⁾	6-25 ¹⁾	6-35	10-50 ¹⁾	50-150
flexible	mm ²	0,75-2,5	0,75-2,5 ¹⁾	1-4	1-4	1,5- 6	1,5- 6	2,5-10 ¹⁾	6-25 ¹⁾	6-35	10-35 ¹⁾	35-120
flexible w. multicore cable end	mm ²	0,75-2,5	0,75-1,5	1-4	1-4	1,5- 6	1,5- 6	2,5-6	6-16	6-35	10-25	-
Conductors to clamp per pole		2	2	2	2	2	2	2	1	1	1	1
Size of terminal screw		M3	M3,5	M4	M4	M4	M4	M5	2xM5	2xM5	2xM6	M10
Tightening torque	Nm	0,6-1,2	0,8-1,4	1,2-1,8	1,2-1,8	1,2-1,8	1,2-1,8	2,5-3	2,5-3	2,5-3	3,5-4,5	10
	lb.inch	5-11	7-12	11-16	11-16	11-16	11-16	22-26	22-26	22-26	31-40	88
Short circuit protection												
Max. fuse size	gL (gG) A	20	20	35	35	50	50	63	100	125	160	250
Rated short-time withstand current (1sec. current)	A	250	250	400	400	500	500	800	1000	1400	1800	3000
Rated conditional short-circuit current	kA _{eff}	10	10	10	10	10	10	10	10	10	10	10
Short-time capacity												
Load duration	3s A	100	100	200	200	350	350	400	600	720	1000	2000
	10s A	60	60	130	130	230	230	250	400	480	600	1200
Note: Ratings applies to contacts already closed	30s A	35	35	85	85	110	110	160	250	300	500	600
	60s A	25	25	65	65	80	80	110	200	250	370	480
Power loss at AC21A												
per pole	A	20	20	32	32	40	50	63	85	115	150	250
	W	0,6	0,5	0,9	1,1	1,5	1,9	2	2,8	4,4	5,7	21
Switching of capacitive loads												
maximum making capacity up to 500V	A	140	140	300	300	350	350	400	600	700	900	1800

Data according to UL and cUL

Type		M10 P	M10H	M20	N20	N33F	N80	N100	N200	L400
Rated voltage	V~	300	600	600	600	600	600	600	600	600
Rated operational current	"General Use" A	20	20	35	35	60	115	130	250	350
	with jumper A	15	-	25	25	40	80	-	-	-
DOL-Rating 3-phase										
	110-120V	hp	1½	1½	5	5	7½	10	15	15
	200-208V	hp	2	2	5	5	10	15	25	25
	220-240V	hp	3	3	5	5	15	20	30	30
	440-480V	hp	-	5	10	10	25	40	40	60
	550-600V	hp	-	7½	15	15	30	50	50	75
DOL-Rating 1-phase										
	110-120V	hp	½	½	1½	1½	3	5	7½	7½
	200-208V	hp	1	1	3	3	5	7½	15	15
	220-240V	hp	1½	1½	5	5	7½	10	15	20
Fuse size (RK5) 5kA / 600V	Manual Motor Controller and Motor Disconnect A	40 ²⁾	40	80	80	150	200	300	350	350
Heavy pilot duty	AC	A300	A600	A600	A600	A600	-	-	-	-
Cable cross sections										
solid	AWG	12 - 20	12 - 20	10 - 18	10 - 18	10 - 12	10 - 12	10 - 14	-	-
flexible	AWG	14 - 20	14 - 20	8 - 18	8 - 18	6 - 12	2 - 12	1 - 14	250kcmil	500kcmil
Tightening torque	Nm	1.7	1-1.7	1.7-2.8	1.7-2.8	2.3-2.8	2.8	4.5	-	-
	lb.inch	15	9-15	15-25	15-25	20-25	25	40	-	-

1) Maximum cable cross-section with prepared conductor

2) 5kA / 300V

Technical Data

Data according to IEC 947-3, IEC 947-5-1, VDE 0660, EN 60947-3, EN 60947-5-1

Type		LTS20	LTS25	LTS32	LTS40	LTS63	LTS80	LT80	LT100	LT125	LT160
Main contacts											
Rated thermal current I_{th} open	A	20	25	32	40	63	80	80	100	125	160
Rated thermal current I_{the} enclosed	A	20	25	32	40	63	80	80/70 ²⁾	100/80 ²⁾	125	160
Rated insulation voltage U_i ¹⁾	V	690	690	690	690	690	690	690	690	1000 ³⁾	1000 ³⁾
Rated operational current I_e AC21A	A	20	25	32	40	63	80	80	100	125	160
Making capacity I_{eff} 3x380-440V	A	160	190	220	300	370	440	600	725	850	1050
Breaking capacity 3x220-240V	A	160	180	200	250	330	380	560	700	800	900
	A	160	180	200	250	330	380	560	650	750	850
	A	80	110	140	170	190	220	200	280	340	340
Disconnection property performed up to	V	690	690	690	690	690	690	690	690	1000 ³⁾	1000 ³⁾
Motor Switch AC3 3x400V	A	9	12	16	23	30	37	45	60	72	85
Motor Switch AC3 3x220-240V	kW	2,2	3	5,5	7,5	11	11	15	18,5	22	30
Direct switching of single motors 3x380-440V	kW	4	5,5	7,5	11	15	18,5	22	30	37	45
	kW	4	5,5	7,5	11	15	15	18,5	22	30	37
Main Switch AC23 3x400V	A	12	16	23	30	45	45	60	72	85	110
Motor Switch, AC23A, 3x220-240V	kW	3	4	5,5	7,5	15	15	18,5	22	30	30
Main Switch, AC23B 3x380-440V	kW	5,5	7,5	11	15	22	22	30	37	45	55
Safety Switch 3x660-690V	kW	5,5	7,5	11	15	18,5	18,5	22	30	37	37
Rated conditional short-circuit current	kA_{eff}	10	10	10	10	10	10	25	25	30	30
Max. fuse size gL (gG)	A	25	35	40	50	63	80	80	100	125	160
Mechanical life	$\times 10^3$	200	200	200	200	100	100	100	100	100	100
Rated short-time withstand current (1sec. current)	A	250	300	400	500	600	850	1600	1850	2500	3000
Maximum cable cross sections											
solid	mm^2	10	10	10	10	25	25	35	35	95	95
	AWG	8	8	8	8	4	4	2	2	3/0	3/0
flexible (+ multicore cable end)	mm^2	6	6	6	6	16	16	25	25	50	50
	AWG	10	10	10	10	6	6	5	5	1/0	1/0
Size of terminal screw		M3,5	M3,5	M3,5	M3,5	M5	M5	-	-	-	-
Tightening torque	Nm	0,8-1,7	0,8-1,7	0,8-1,7	0,8-1,7	2-4	2-4	3	3	14	14
	lb.inch	7-15	7-15	7-15	7-15	18-35	18-35	26	26	124	124
Auxiliary contacts											
Rated insulation voltage U_i ¹⁾	V	690	690	690	690	690	690	690	690	690	690
Rated thermal current I_{th} , I_{the}	A	10	10	10	10	10	10	16	16	16	16
Switching capacity AC15 220-240V	A	2,5	2,5	2,5	2,5	2,5	2,5	6	6	6	6
	A	1,5	1,5	1,5	1,5	1,5	1,5	3	3	4	4
Rated conditional short-circuit current	kA_{eff}	3	3	3	3	3	3	3	3	3	3
Max. short circuit protection gL (gG)	A	10	10	10	10	10	10	16	16	16	16
Maximum cable cross sections											
solid	mm^2	2,5	2,5	2,5	2,5	2,5	2,5	4	4	4	4
	AWG	12	12	12	12	12	12	12	12	12	12
flexible (+ multicore cable end)	mm^2	2,5	2,5	2,5	2,5	2,5	2,5	2,5	2,5	2,5	2,5
	AWG	14	14	14	14	14	14	14	14	14	14

Data according to UL und cUL

Type		LTS20	LTS25	LTS32	LTS40	LTS63	LTS80	LT80	LT100	LT125	LT160	
Rated voltage	V	600	600	600	600	600	600	600	600	600	600	
Ampere-Rating "General use"	A	20	25	32	40	63	80	80	100	150	200	
DOL-Rating 3-phase 110-120V	HP	0,75	1	1,5	2	3	5	7,5	10	15	20	
	HP	1,5	2	3	5	7,5	10	20	25	30	40	
	HP	3	5	7,5	10	15	20	40	50	60	60	
	HP	5	7,5	10	15	20	25	50	50	60	60	
DOL-Rating 1-phase 110-120V	HP	0,3	0,5	0,5	1	1,5	2	3	5	-	-	
	HP	0,5	0,75	1	2	2	3	-	-	-	-	
	HP	0,7	1	1,5	3	3	5	10	15	-	-	
Fuse size (RK5) 5kA / 600V	Manual Motor Controller	A	40	50	50	70	90	110	200 ⁴⁾	250 ⁴⁾	350 ⁴⁾	400 ⁴⁾
	Motor Disconnect	A	40	50	50	50	70	70	200 ⁴⁾	250 ⁴⁾	350 ⁴⁾	400 ⁴⁾

1) suitable for: earthed-neutral systems, overvoltage category I to III, pollution degree 3 (standard-industry): $U_{imp} = 6kV$. Data for other conditions on request

2) the values after the slash are valid for switches 6-pole or more

3) Suitable for no load applications(AC20A) above 690V

4) Fuse RK1 / 10kA / 600V

Technical Data





Data according to IEC 947-3, IEC 947-5-1, VDE 0660, EN 60947-3, EN 60947-5-1

Type		L100	L160	L400	L600	L800	L1200
Rated insulation voltage U_i	V	690 ²⁾	690 ²⁾	690 ²⁾	690 ²⁾	690 ²⁾	690 ²⁾
Rated thermal current I_{th} open	A	125	180	400	600	800	1200
Rated thermal current I_{the} encl.	A	125	180	400	600	800	1200
with conductor	mm ²	50	70	40x5	40x10	busbar 2x40x10	busbar 2x50x10
Utilization category AC21A, AC21B							
Switching of resistive loads, including moderate overloads							
Rated operational current I_e	A	125	180	400	400	400	400
Shot-time current-carrying capacity							
Load duration	1s	-	-	4800	6500	8500	10000
	3s	800	1200	3600	5000	6500	8000
	10s	500	800	2000	3200	4000	5800
Note: Ratings applies to contacts already closed	30s	320	480	1200	1700	2200	3200
	60s	180	380	960	1300	1700	2300
Cable cross-sections							
solid or stranded	mm ²	25-50 ¹⁾	cable lug	busbar	busbar	busbar	busbar
flexible	mm ²	25-50 ¹⁾	70	40x5	40x10	2x40x10	2x50x10
flexible with multicore cable end	mm ²	25-35	-	-	-	-	-
Size of terminal screw		2xM5	M8	M12	M16	M16	M16
Number of conductors to clamp per pole		1	1	1	2	1	1
Short circuit protection							
Max. fuse size	slow, gL (gG)	A	125	200	400	630	800 1250

1) Maximum cable cross-section with prepared conductor

2) suitable for: earthed-neutral systems, overvoltage category I to III, pollution degree 3 (standard-industry): $U_{imp} = 6kV$. Data for other conditions on request

Approvals

Country	USA, Canada UL	Switzerland SEV	Europe	Russia GOST	CB/CCA- Certificates
Type					

Cam Switches (UL-Listed as MANUAL MOTOR CONTROLLER and suitable as MOTOR DISCONNECT)

M10	o	o	o	o	o
M10H	o	o	o	o	o
M20	o	o	o	o	o
N20	o	o	o	o	o
N33F	o	o	o	o	o
N40	-	o	o	o	o
N60	-	o	o	o	o
N80	o	o	o	o	o
N100	o	o	o	o	o
N200	o	o	o	o	o
L400	o	-		-	-

Switch disconnectors (UL-Listed as MANUAL MOTOR CONTROLLER and suitable as MOTOR DISCONNECT)

LTS20	o	o	o	o	o
LTS25	o	o	o	o	o
LTS32	o	o	o	o	o
LTS40	o	o	o	o	o
LTS63	o	o	o	o	o
LTS80	o	o	o	o	o
LT80	o	-	o	-	o
LT100	o	-	o	-	o
LT125	o	-	o	-	-
LT160	o	-	o	-	o

o In standard version approved
- Not provided for test till now

/ No testing required CE

x In test

Panel mounting E
M10 - N100

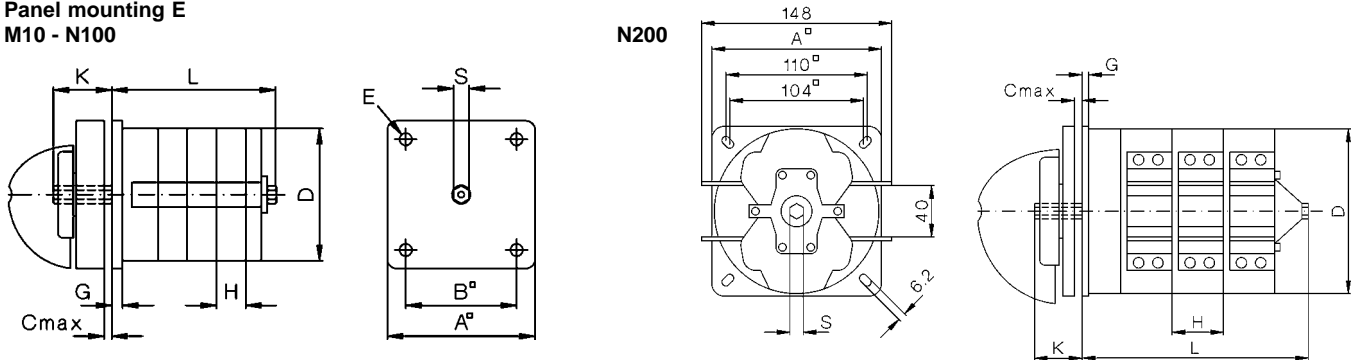

Type	A	B	C	D	D1	D2	D3	E	G	H	K	S
M10H	48	36	5	44 ¹⁾	5	8	-	4	3,5	9,5	19	SW5
M20	48	36	5	56	5	8	-	4	3,5	12,5	19	SW5
N20	64	48	5	56	5	12	57	4,2	3	12,5	20	SW7
N33F	64	48	5	58 ²⁾	5	12	-	4,2	3	15,5	20	SW7
N40	86	68	7	80	6	12	82	5,2	3,5	18	24,5	SW9
N60	86	68	7	80	6	12	82	5,2	3,5	29,5	24,5	SW9
N80	86	68	7	80	6	12	82	5,2	3,5	29,5	24,5	SW9
N100	132	110	9	128	7	16	129	6,2	5	30	37	SW12
N200	132	110	9	128	7	16	-	6,2	5	40	37	SW12

Mounting holes: built in from ear

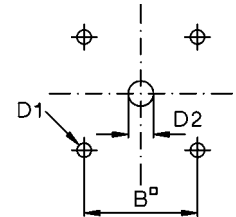

Mounting holes: built in from front

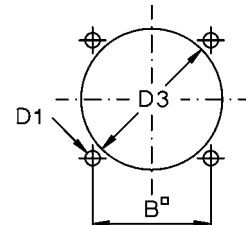

Type	Dimension L with ... cells														
	1	2	3	4	5	6	7	8	9	10	11	12	13	14	15
M10H	36,5	46	55,5	65	74,5	84	93,5	103	112,5	122	131,5	141	-	-	-
M20	38,5	51	63,5	76	88,5	101	113,5	126	138,5	151	163,5	176	-	-	-
N20	40,5	53	65,5	78	90,5	103	115,5	128	140,5	153	165,5	178	190,5	203	215,5
N33F	44	59,5	75	90,5	106	121,5	137	152,5	168	183,5	199	214,5	230	245,5	261
N40	52,5	70,5	88,5	106,5	124,5	142,5	160,5	178,5	196,5	214,5	232,5	250,5	268,5	286,5	304,5
N60	64	93,5	123	152,5	182	211,5	241	270,5	300	329,5	359	388,5	-	-	-
N80	64	93,5	123	152,5	182	211,5	241	270,5	300	329,5	359	388,5	-	-	-
N100	88	118	148	178	208	238	268	298	328	358	388	418	-	-	-
N200	96	136	176	216	256	296	336	376	416	456	496	536	-	-	-

Central fixing Z
M10H, M20, N33F

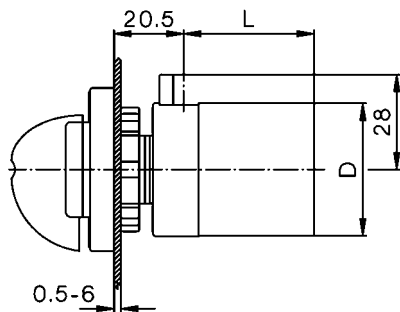

Central fixing without escutcheon plate ZO
M10H, M20

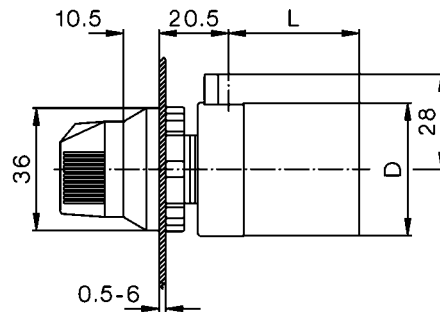

Mounting hole:

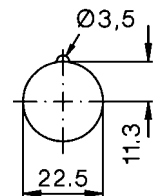

Further dimensions see tables above

Mini-Cam Switches M4H

Panel mounting E

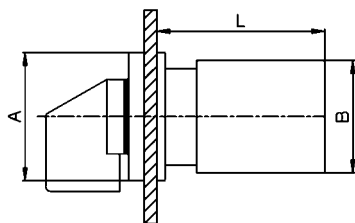

Central fixing Z, ZO

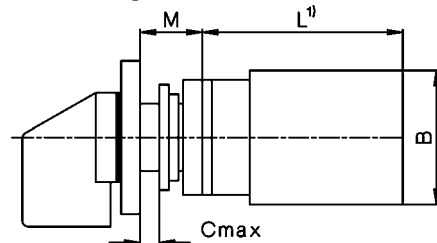

ZO

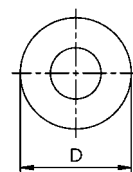

Z

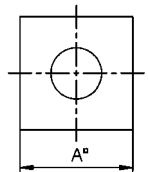

Type	A	B	D	M	Dimension L with ... cells								
					1	2	3	4	5	6	7	8	
M4H	mm	30	28	29,5	12,5	38,5	50,5	62,5	74,5	86,5	98,5	110,5	122,5

Flush mounting UP M10

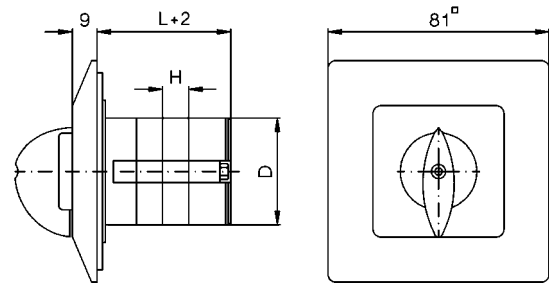

N20 (dimensions of standard flush wall mounting box see page 90)

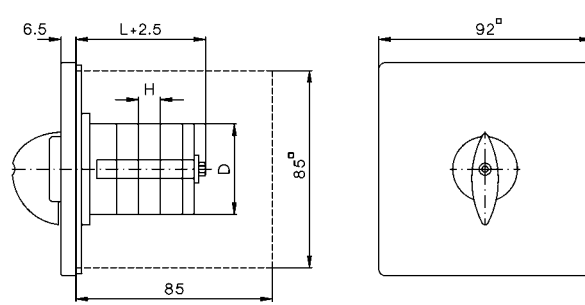

Base mounting V M10H - N100

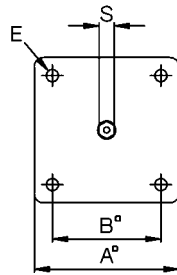
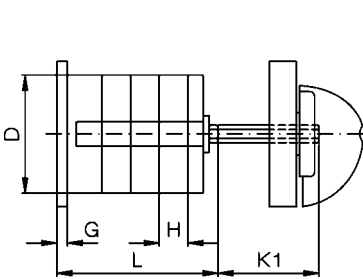

N200

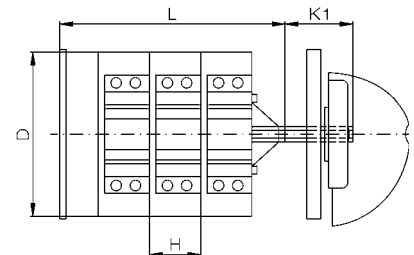
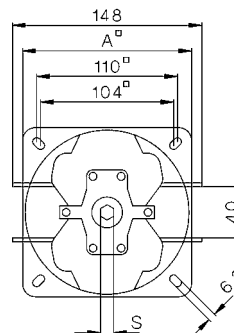

Type	A	B	D	D1	D2	E	G	H	I	K	K1	S
M10	48	36	39	5	8	4	3,5	9,5	6	19	41	SW5
M10H	48	36	44 ¹⁾	5	8	4,2	3	9,5	6	19	41	SW5
M20	48	36	56	5	8	4,2	3	12,5	6	19	47	SW5
N20	64	48	56	5	12	4,2	3	12,5	0	20	29	SW7
N33F	64	48	58 ²⁾	5	12	4,2	3	15,5	0	20	31,5	SW7
N40	86	68	80	6	12	5,2	3,5	18	-	-	38,5	SW9
N60	86	68	80	6	12	5,2	3,5	29,5	-	-	49,5	SW9
N80	86	68	80	6	12	5,2	3,5	29,5	-	-	49,5	SW9
N100	132	110	128	7	16	6,2	5	30	-	-	79,5	SW12
N200	132	110	128	7	16	6,2	5	40	-	-	104	SW12

Mounting holes: for escutcheon plate

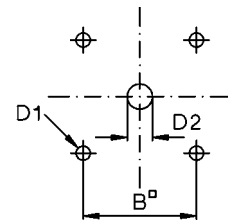

Type	Dimensions L with .. cells														
	1	2	3	4	5	6	7	8	9	10	11	12	13	14	15
M10	34,5	44	53,5	63	72,5	82	91,5	101	110,5	120	129,5	139	-	-	-
M10H	36,5	46	55,5	65	74,5	84	93,5	103	112,5	122	131,5	141	-	-	-
M20	38,5	51	63,5	76	88,5	101	113,5	126	138,5	151	163,5	176	-	-	-
N20	40,5	53	65,5	78	90,5	103	115,5	128	140,5	153	165,5	178	190,5	203	215,5
N33F	44	59,5	75	90,5	106	121,5	137	152,5	168	183,5	199	214,5	230	245,5	261
N40	52,5	70,5	88,5	106,5	124,5	142,5	160,5	178,5	196,5	214,5	232,5	250,5	268,5	286,5	304,5
N60	64	93,5	123	152,5	182	211,5	241	270,5	300	329,5	359	388,5	-	-	-
N80	64	93,5	123	152,5	182	211,5	241	270,5	300	329,5	359	388,5	-	-	-
N100	88	118	148	178	208	238	268	298	328	358	388	418	-	-	-
N200	96	136	176	216	256	296	336	376	416	456	496	536	-	-	-

Snap-on mounting SM

M10H - N33F for 35mm DIN-rail mounting according to DIN EN 50022

Dimensions see tables above

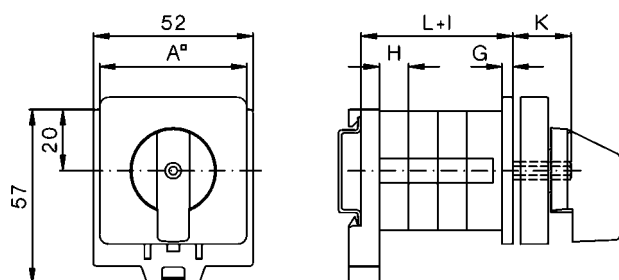

Switch with installation cover SMA

M10H, M20 for 35mm DIN-rail mounting according to DIN EN 50022

Type	Dimension X with .. cells					Dimension Y with .. cells				
	1, 2	3	4	5	1, 2	3	4	5		
M10H	44	44	61	76	60	60	75	90		
M20	44	61	76	76	60	75	90	90		

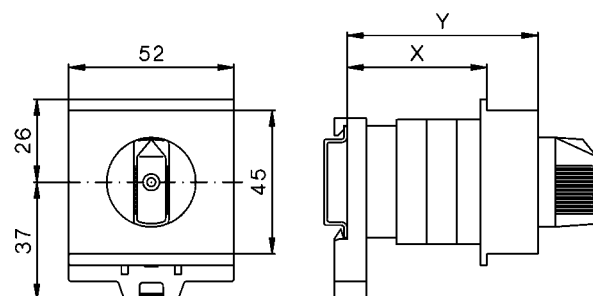

Plastic enclosed switches P, PF M10 - N60

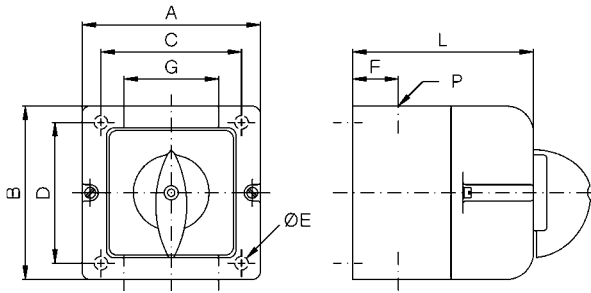

N100, N200

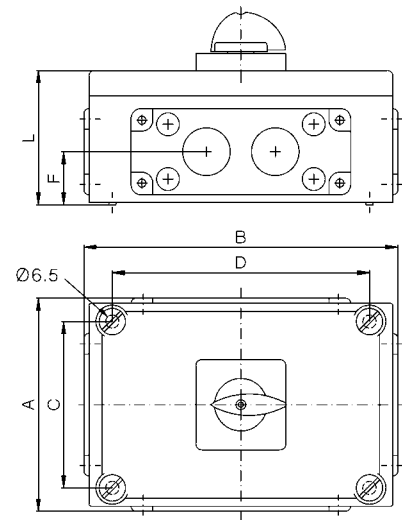

N60, N80

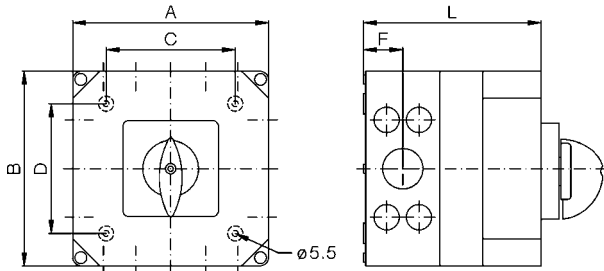

1) knock outs for M40/M32 + 4x M20 at top and bottom
M32/M25 + 4x M20 at the right and left hand side,

2) 2 flange plates with hole 50,5 at top and bottom

3) 2 flange plates with hole 50,5 at top and bottom, can also be mounted at the right and left hand side

Type	A	B	C	D	E	F	G	P	Dimension L with .. cells					
									1	2	3	4	5	6
M10	66	64	50	36	5	15,5	26	M20	43	52	62	71	81	90
N20	82	78	57	53	4,5	17	35	M20	66	66	80	94	108	122
N33F	112	108	85	50	5	20	50	M25	92	92	92	110	128	146
N40	112	108	85	50	5	20	50	M25	92	92	110	128	146	164
N60	112	108	85	50	5	20	50	M25	92	110	-	-	-	-
N60	182	180	120	120	5,5	36,5	-	1)	-	-	165	215	215	-
N80	182	180	120	120	5,5	36,5	-	1)	110	110	165	215	215	-
N100	210	310	165	255	6,5	52,5	-	2)	130	130	180	-	-	-
N200	310	310	255	255	6,5	52,5	-	3)	130	180	230	-	-	-

Motor terminal box mounting KE M10 - N33F

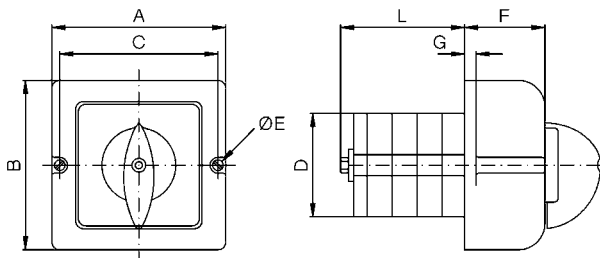

Mounting holes

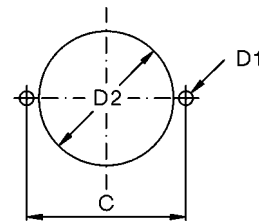

Type	A	B	C	D	D1	D2	E	F	G	Dimension L with .. cells					
										2	3	4	5	6	
M10	66	64	58	39	4	48	3,2	24	6	22	31,5	41	50,5	60	
N20	82	78	71	48	5	57	4,2	34	5	24,5	37	49,5	62	74,5	
N33F	112	108	100	56	5	70	4,2	49	11	32,5	48	63,5	79	94,5	

Plastic enclosed motor starter PM N20

Typ	P	Dimension L with .. cells					
		1	2	3	4	5	6
N20	M25	80	80	80	92,5	105	117,5

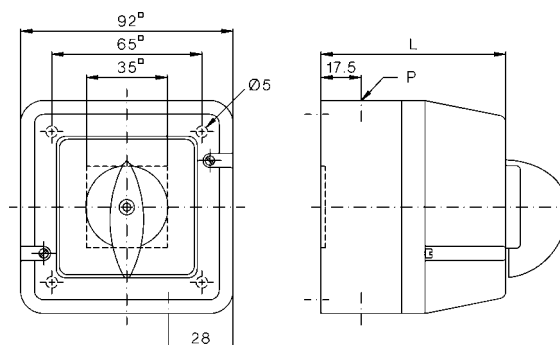

4) old version

Telux - Cam Switches

Cast aluminium enclosed switches G, GF
N20 - N200

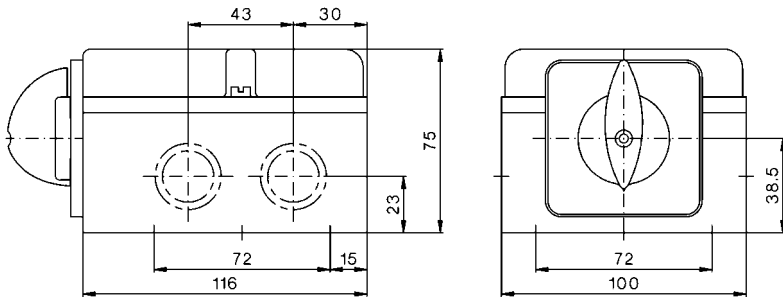

N20 4 x M25
N32 4 x M25

1) old version

Plastic enclosure horizontal PLF (Replacement for cast aluminium enclosure G, GF)
N40, N60, N80

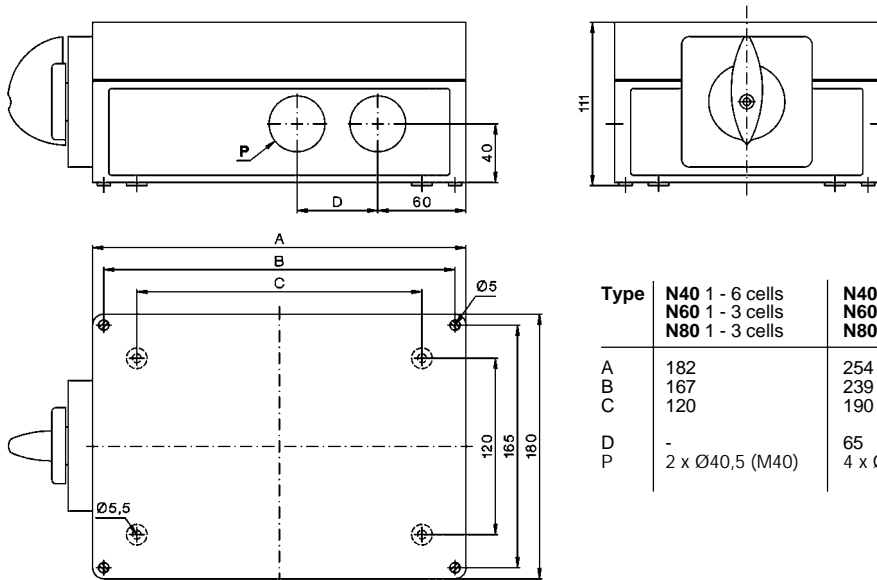

Type	N40 1 - 6 cells N60 1 - 3 cells N80 1 - 3 cells	N40 7 - 10 cells N60 4 - 6 cells N80 4 - 6 cells
A	182	254
B	167	239
C	120	190
D	-	65
P	2 x Ø40,5 (M40)	4 x Ø40,5 (M40)

Main Switches, Switch Disconnectors LT(S)..

Panel mounting LT(S).. E(HN)..

On-OFF Switches 3-pole, 4-pole

On-OFF Switches 6-pole, 8-pole

Changeover Switches 3-pole, 4-pole

Mounting holes

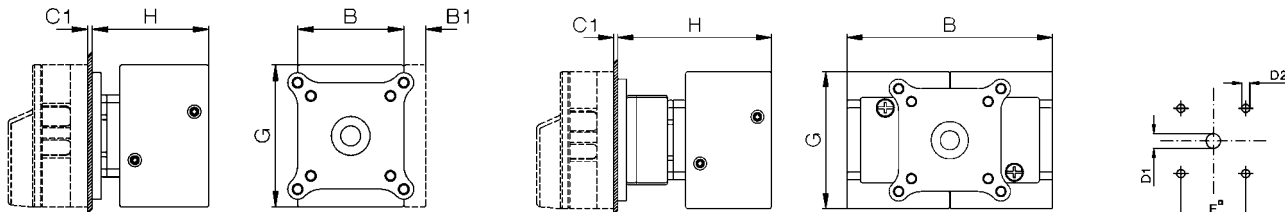

Single hole mounting LTS.. Z(HN)..

On-OFF Switches 3-pole, 4-pole

Mounting holes

Mounting of add-on modules

Panel mounting, Single hole mounting

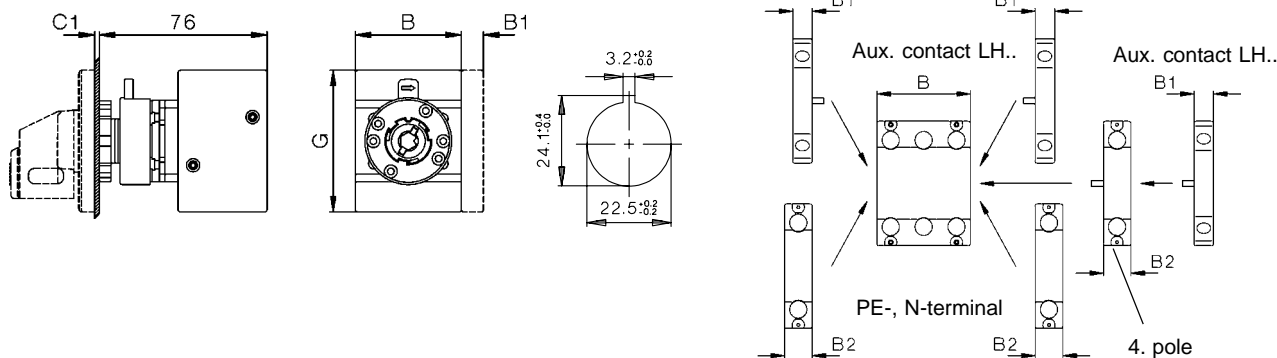

Type	Escutch. plate or padlock device	3-pole		4-pole		6-pole		8-pole		aux. contact B1	4 pole PE				G	3-pole 4-pole		6-pole 8-pole	
		A	B	B	B	B	B	B2	C1		D1	D2	E	F		H	H	H	
LTS..	48 □, SV1	48	48	62,5	-	-	-	-	10	14,5	1-5	10	5	36	-	64	54	-	-
LTS..	64 □, SV4, SV164	64	48	62,5	97	126	-	-	10	14,5	1-5	10	5	48	-	64	54	74	-
LT80..	64 □, SV34	64	70	92	140	-	-	-	11	-	1-4	10-15	5	48	40,2	80	71	82	82
LT100..	64 □, SV34	64	70	92	140	-	-	-	11	-	1-4	10-15	5	48	40,2	80	71	82	82
LT125/160	88 □, SV34	88	112	150	224	-	-	-	-	-	1-4	13-17	6	68	49,3	108	96	98	98

Escutcheon plate

48 □

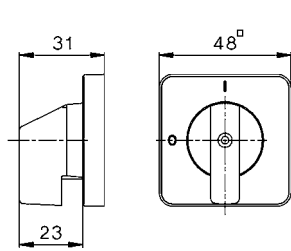

64 □

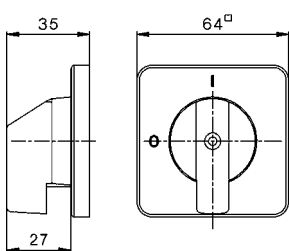

Padlock devices

SV1

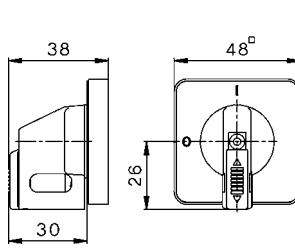

SV164

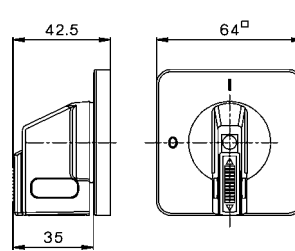

Padlock devices

SV4

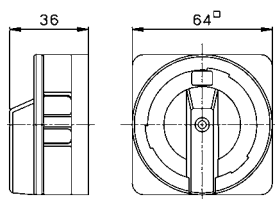

SV488

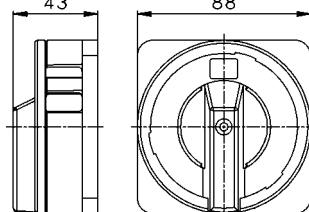

SV34

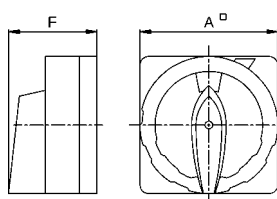

Switch disconnectors LT(S)

Main Switches, Switch Disconnectors LT(S)..

Base mounting LTS.. VZV(HN)..

On-OFF Switches 3-pole, 4-pole

$L = X - 40 \pm 3$

6-pole
for LTS20 - 40 only
 $L = X - 40 \pm 3$

On-OFF Switches 6-pole, 8-pole
Changeover Switches 3-pole, 4-pole
 $L = X - 60 \pm 3$

Mounting holes

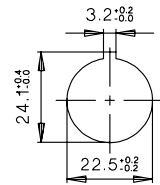
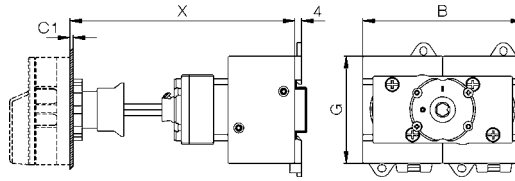
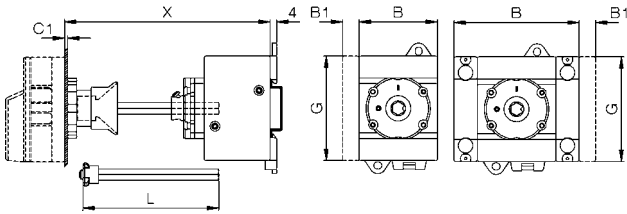

Base mounting LT(S).. V(HN)..

On-OFF Switches 3-pole, 4-pole

$L = T - 60 \pm 3$ for LTS20 - 80 only

6-pole
for LTS20 - 40 only
 $L = X - 60 \pm 3$

On-OFF Switches 6-pole, 8-pole
Changeover Switches 3-pole, 4-pole
 $L = T - 80 \pm 3$ for LTS20 - 80 only

Mounting holes

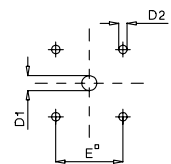
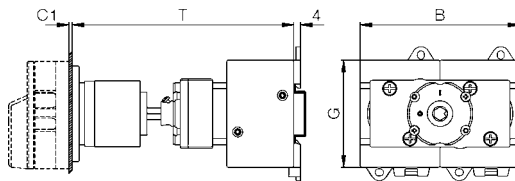
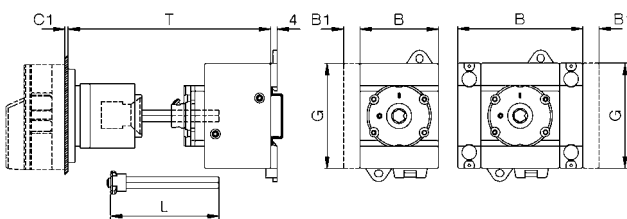

Base mounting LTS.. VZ(HN)..

On-OFF Switches 3-pole, 4-pole

6-pole
for LTS20 - 40 only

On-OFF Switches 6-pole, 8-pole
Changeover Switches 3-pole, 4-pole

Mounting holes

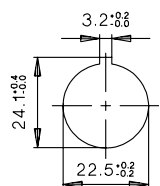
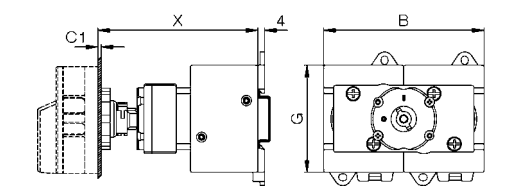
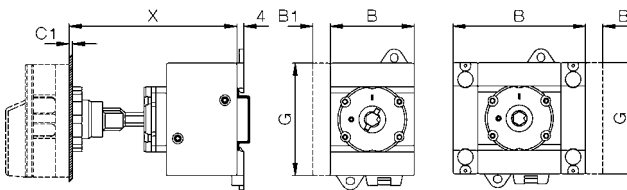

Type	Escutch. plate or padlock device	3-pole		4-pole	6-pole	8-pole	aux. contact B1	4.Pole PE B2									
		A	B	B	B	B			C1	D1	D2	D3	E	G	K	K1	J
LTS20 -40	64 □, SV4, SV164	64	48	48	77	97	10	14,5	1-5	10	5	M4	48	64	25	48	70
LTS63, 80	64 □, SV4, SV164	64	48	62,5	97	126	10	14,5	1-5	10	5	M4	48	64	25	48	70
LT80..	64 □, SV34	64	70	92	140	-	11	-	1-4	10/24 ¹⁾	5	M5	48	80	25	70	90
LT100..	64 □, SV34	64	70	92	140	-	11	-	1-4	10/24 ¹⁾	5	M5	48	80	25	70	90
LT125/160	88 □, SV34	88	112	150	224	-	-	-	1-4	13/27 ²⁾	6	M6	68	108	36	-	120

Base mounting

On-OFF Switches **LTS20 - LT100**

3-pole, 4-pole

6-pole LTS20 -40

6-pole, 8-pole

Changeover Switches

LT125, LT166

3-pole, 4-pole

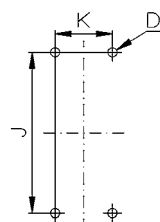
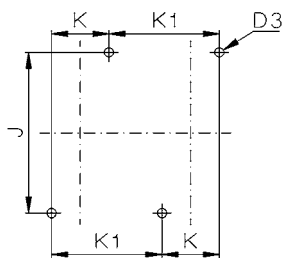
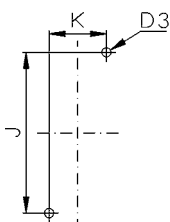

Mounting of Accessories

Base mounting, for distribution boards

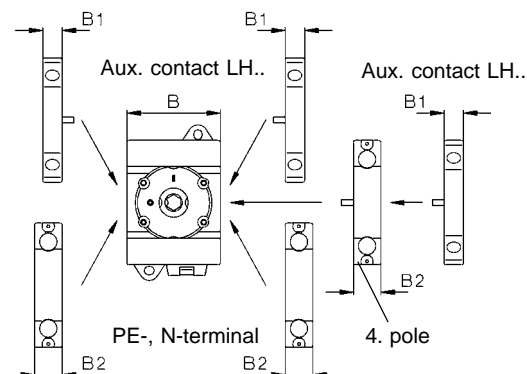

1) Ø 22-25 for LT80(100) VH(N)34 .. only
2) Ø 26-30 for LT125(160) VH(N)34 .. only

Main Switches, Switch Disconnectors LT(S)..

Switches for Distribution Boards LT(S).. SMA(HN)..

On-OFF Switches 3-pole, 4-pole

On-OFF Switches 6-pole
for LTS20 - 40 only

On-OFF Switches 6-pole, 8-pole
Changeover Switches 3-pole, 4-pole

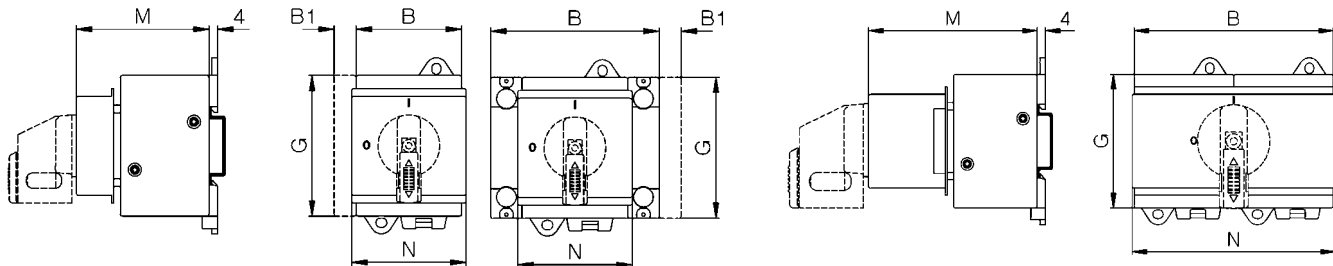

Type	padlock device	3-pole	4-pole	6-pole	8-pole	aux. contact	4.pole PE	G	3-pole 4-pole	6-pole	8-pole	3-pole 4-pole	6-pole	8-pole
		B	B	B	B	B1	B2		M	M	M	N	N	N
LTS20 - 40	SV1, SV164	48	48	77	96	10	14,5	64	60	60	74	52	52	97 ¹⁾
LTS63, 80	SV1, SV164	48	62,5	96	125	10	14,5	64	60	74	74	52	97 ¹⁾	126
LT80..	SV1	70	92	140	-	11	-	80	70	70	70	70	70	-
LT100..	SV1	70	92	140	-	11	-	80	70	70	70	70	70	-

1) inclusiv removable cover parts 126mm

Maintenance and Safety Switches LT(S)..PF..

Type	Pole	A	B	D1	D2	E	F	H
LTS20 PFH.. A., LTS40 PFH.. A	3, 4	130	98	2x25,5/20,5	-	75	100	77
LTS63 PFH.. A., LTS80 PFH.. A.	3, 4	200	120	40,5/32,5 +16,5	-	95	165	86
LTS20 PFH.. A., LTS40 PFH.. A	6, 8	240	160	40,5/32,5	-	130	228	120
LTS63 PFH.. A., LTS80 PFH.. A.	6, 8	240	160	40,5/32,5	-	130	228	120
LT80 PFH.. A., LT100 PFH.. A.	3, 4	250	145	2x40,5	25,5	124	229	100
LT125 PFH.., LT160 PF..	3	300	200	2x50,5	25,5	172	272	172
LT125 PFH.., LT160 PF..	4	300	280	2x50,5	-	254	254	180

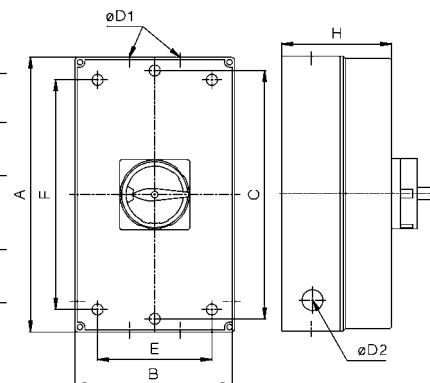

Switch Disconnectors in Plastic Enclosure LTS..PF..

Type	Pole	A	B	D1	E	F	H
LTS20 PF A., LTS40 PF A	3, 4	130	98	2x25,5/20,5	75	100	77
LTS63 PF A., LTS80 PF A.	3, 4	200	120	40,5/32,5 +16,5	95	165	86

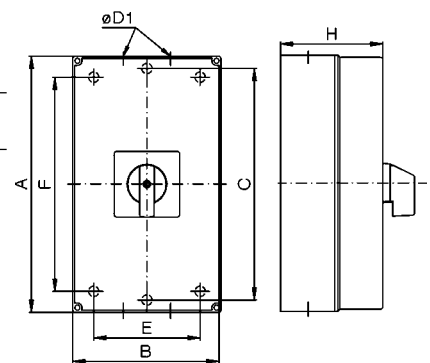

Main and Emergency Off Switches

Panel mounting , Central fixing M10H ..

Type	C	D1	D2	E	L
M10H EHN1 A2	1-5	8	5	36	36,5
M10H EHN1 A3	1-5	8	5	36	46
M10H EHN1 A4	1-5	8	5	36	46
M10H ZHN1 A2	1-5	-	-	-	52
M10H ZHN1 A3	1-5	-	-	-	63
M10H ZHN1 A4	1-5	-	-	-	63

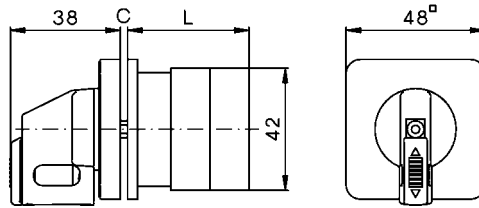

Mounting holes
Panel mounting
M10H E ..
Central fixing
M10H Z ..

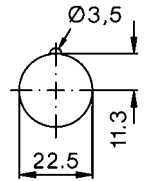

Panel mounting EH3, EHN3
N40 - N200

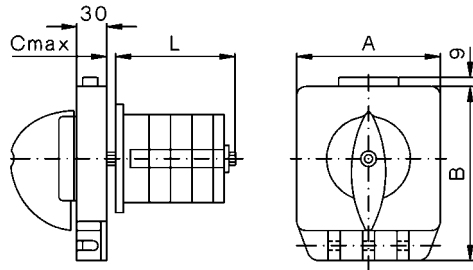

Base mounting VH3, VHN3
N40 - N200

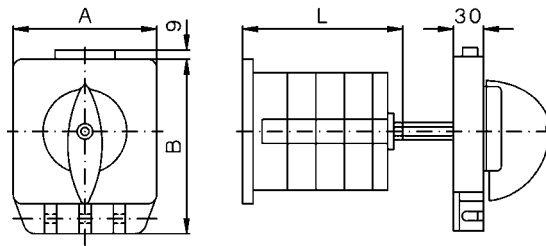

Bohrplan

Type	A	B	B1	C	D1	D2	Dimension L with ... cells		
							1	2	3
N40	102	128	68	5	6	12	52,5	70,5	88,5
N60	102	128	68	5	6	12	64	93,5	123
N80	102	128	68	5	6	12	64	93,5	123
N100	132	160	110	8	7	16	88	118	148
N200	132	160	110	8	7	16	96	136	176

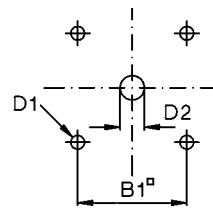

Panel mounting EH4, EHN4
N20 - N80

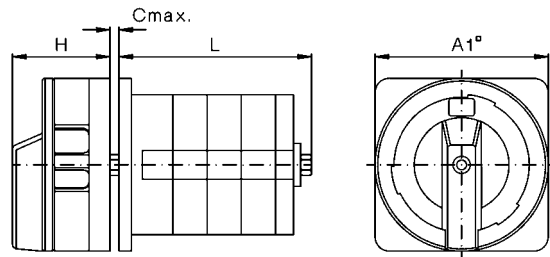

Base mounting VH4, VHN4
N20 - N80

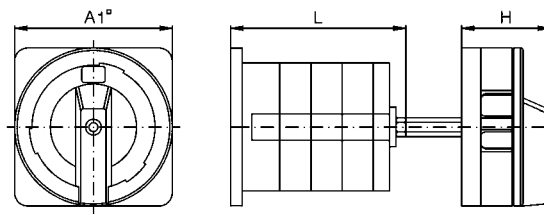

Type	A1	B1	C	D1	D2	H	Dimension L with ... cells		
							1	2	3
M10H	64	48	5	5	12	23	36,5	46	55,5
N20	64	48	5	5	12	23	40,5	53	65,5
N33F	64	48	5	5	12	23	44	59,5	75
N40	86	68	7	6	20	30	52,5	70,5	88,5
N60	86	68	7	6	20	30	64	93,5	123
N80	86	68	7	6	20	30	64	93,5	123

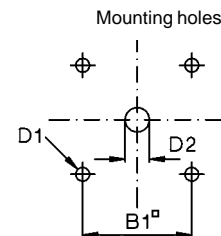

Load Switches

Panel mounting E
L100 - 400, L800, L1200

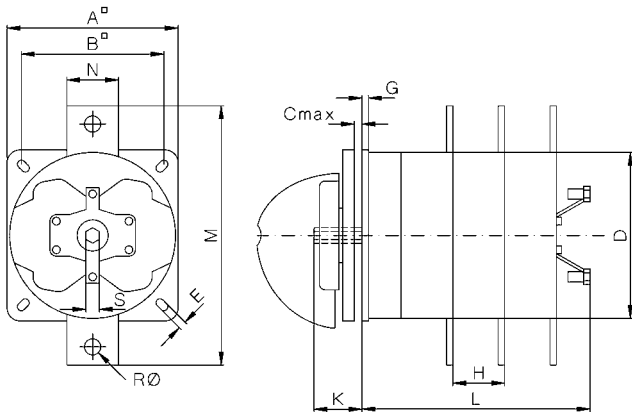

L600

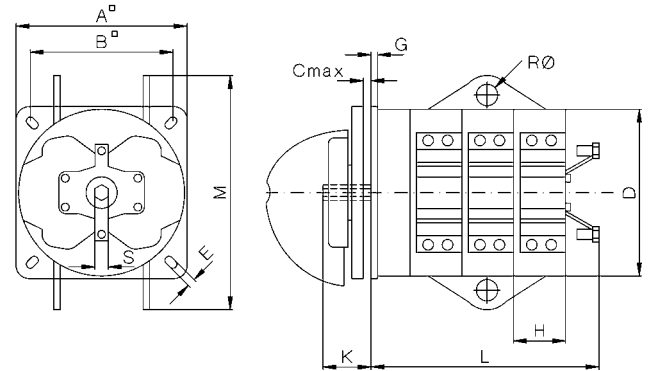

Base mounting V
L100 - 400, L800, L1200

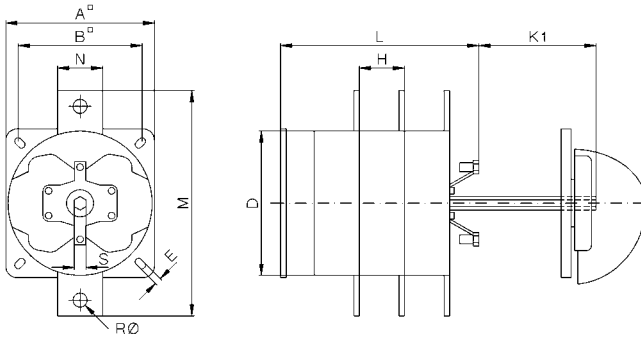

L600

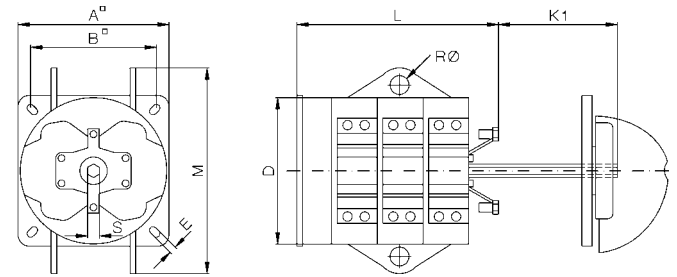

Type	A	B	C	D	D1	D2	E	G	H	K	K1	M	N	R	S
L100	86	68	7	80	6	12	5,2	3,5	18	24,5	38,5	103	27	-	SW9
L160	86	68	7	80	6	12	5,2	3,5	29,5	24,5	38,5	115	-	8,5	SW9
L400	132	110	9	128	7	16	6,2	5	40	37	104	200	40	12,5	SW12
L600	132	110	9	128	7	16	6,2	5	40	37	104	180	-	16,5	SW12
L800	132	110	9	128	7	16	6,2	5	40	37	104	240	40	16,5	SW12
L1200	132	110	9	128	7	16	6,2	5	40	37	104	240	40	16,5	SW12

Mounting holes :

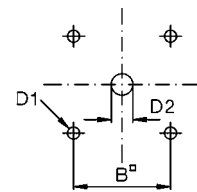

Type	Dimension L with ... cells											
	1	2	3	4	5	6	7	8	9	10	11	12
L100	52,5	70,5	88,5	106,5	124,5	142,5	160,5	178,5	196,5	214,5	232,5	250,5
L160	64	93,5	123	152,5	182	211,5	241	270,5	300	329,5	359	388,5
L400	96	136	176	216	256	296	336	376	416	456	496	536
L600	96	136	176	216	256	296	336	376	416	456	496	536
L800	96	136	176	216	256	296	336	376	416	456	496	536
L1200	96	136	176	216	256	296	336	376	416	456	496	536

Operating Knobs and Handles

Instrument knob G.

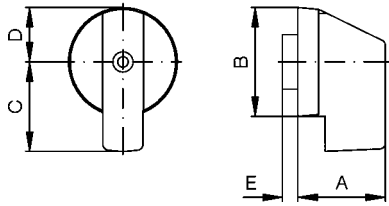

Type	A	B	C	D	E
M10, M10H, M20	23	28	24	14	4
N20, N33F	27	36	32	18	3

Twist knob R.

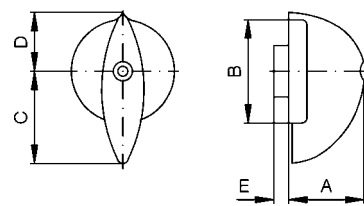

Type	A	B	C	D	E
M10, M10H, M20	20,5	28	25	15	4
N20, N33F	24	36	29,5	19	3
N40, N60, N80, L100, L160	31	49	41	28	3,5
N100, N200, L400, L600, L800, L1200	50	75	62	41	2,5

Toggle knob K.

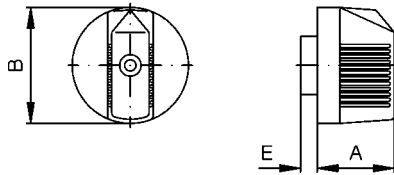

Type	A	B	E
M10, M10H, M20	18,5	28	4
N20, N33F	24	36	3

Hand wheel HR

N100, N200,
L400, L600, L800, L1200

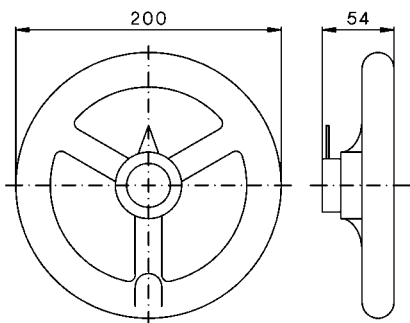

Ball type handle B.

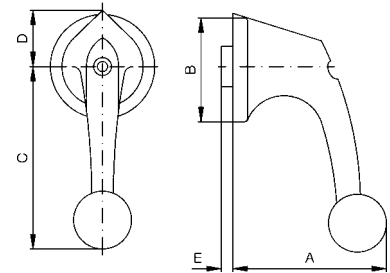

Type	A	B	C	D	E
N20, N33F	53	36,5	64	21	3
N40, N60, N80, L100, L160	62	49	82	31	3,5
N100, N200, L400, L600, L800, L1200	63	75	110	45	2,5

Code number for colour

grey	.1	white	.5
black	.2	blue	.6
red	.3	yellow	.7
cream-coloured	.4	euro-white	.8

Escutcheon plates

Escutcheon plate

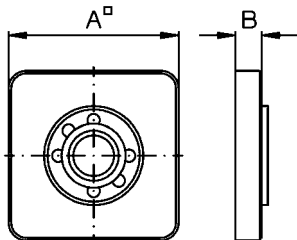

Type	A	B
M10, M10H, M20	48	7,5
N20, N33F	64	7,5
N40, N60, N80, L100, L160	88	8
N100, N200, L400, L600, L800, L1200	132	9

Rectangular additional plate SRE

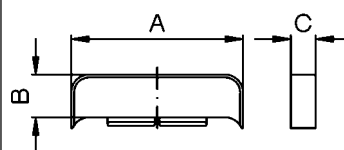

Type	A	B	C
M10, M10H, M20	48	12	7,5
N20, N33F	64	14	7,5
N40, N60, N80, L100, L160	88	22	8
N100, N200, L400, L600, L800, L1200	132	31	9

Big rectangular additional plate SRE2

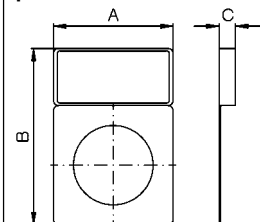

Type	A	B	C
M10, M10H, M20	48	69	6
N20, N33F	64	91	6

Special drives

Removable knob drive STGR, STGR2
M10H - N33F

Type	B	C	D1	D2	D3
M10H, M20	36	5	5	12	18
N20, N33F	48	5	5	12	18

Replace dimension D2 with dimension D3 for STGR2
Dimension L see page 77

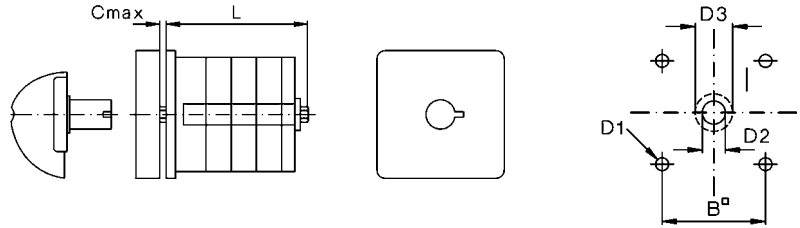

Mounting holes

Switch with roller arm RH
N20, N33F

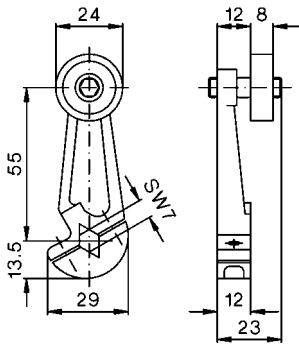

N40 - N80

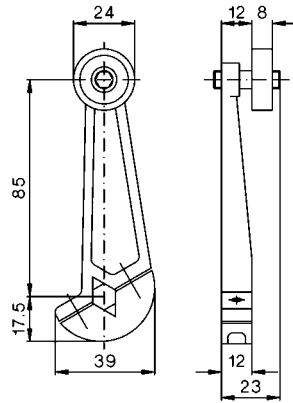

Switch with reinforced roller arm RHS1, RHS2
N20

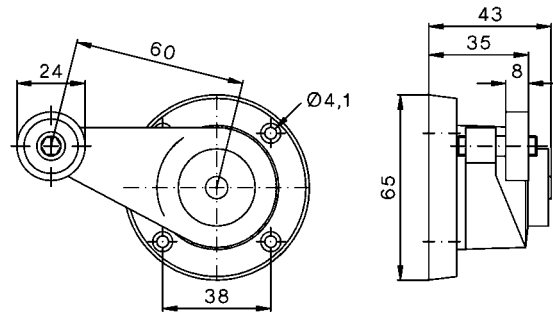

Switch with eyelet lever ÖH
N20, N33F

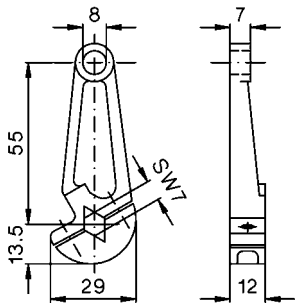

N40 - N80

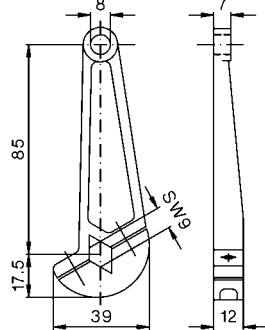

Switch with reinforced eyelet lever ÖHS1, ÖHS2
N20

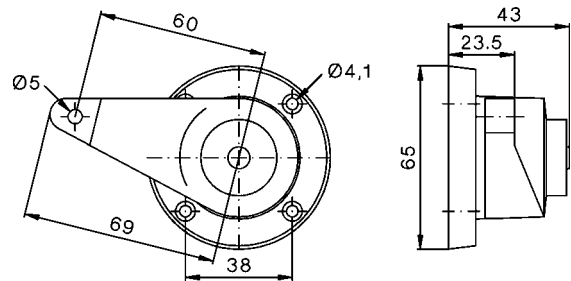

Switch with double arm eyelet lever ÖH2
N20

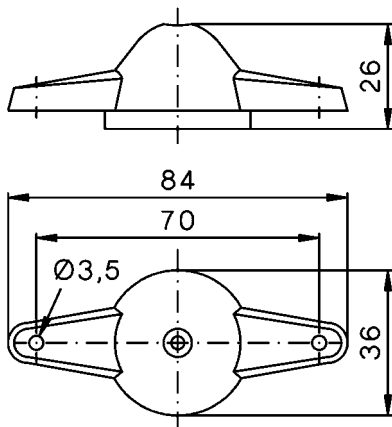

Footswitch FUSS1, Stepswitch FUSS2
N20

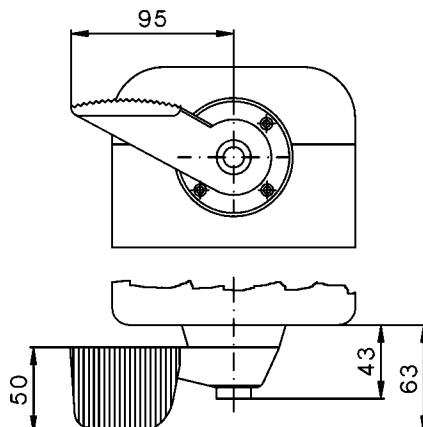

Double arm footswitch FUSS3
N20

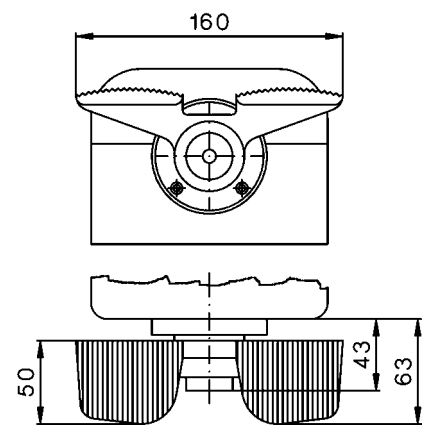

Door couplings

Dimension T is a minimum value. In case of order the dimension T is necessary.

Door coupling TK, TKFR N40 - L1200

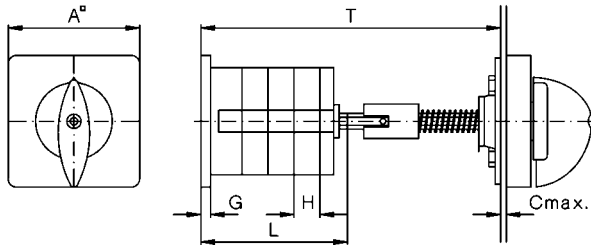

Door coupling, lockable TK2, TK2FR N40 - L1200

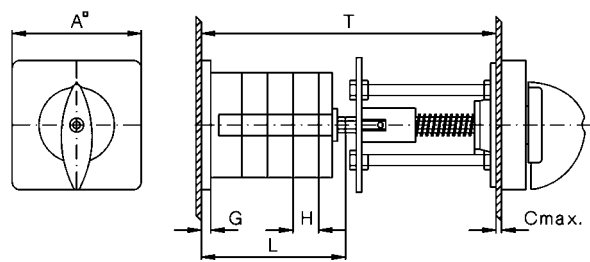

Door coupling TKE, TK2E M10H, M20, N20, N33F

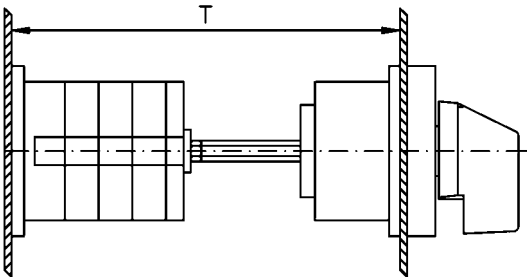

Mounting holes:
TK, TKFR, TK2, TK2FR
TKE, TK2E

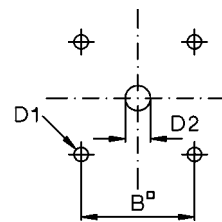

Door coupling, lockable TK2Z M10H, M20, N20, N33F

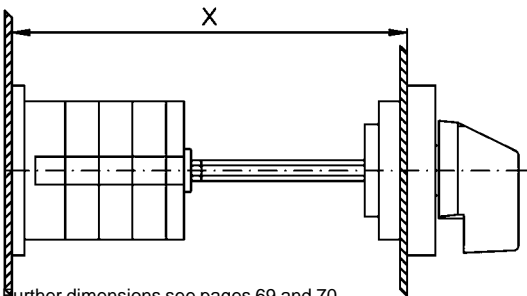

Mounting holes:
TKZ

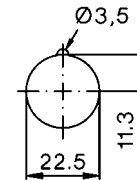

Further dimensions see pages 69 and 70.

Dimension T is a minimum value dependent on switch Type and number of cells. For ordering dimension T is necessary

Type	A	B	C	D1	D2	Minimum dimension T with .. cells							
						1	2	3	4	5	6	7	8
M10H	48	36	5	5	8	108	117,5	127	136,5	146	155,5	165	174,5
M20	48	36	5	5	8	100	112,5	125	137,5	150	162,5	175	187,5
N20	64	48	5	5	10	100	112,5	125	137,5	150	162,5	175	187,5
N33F	64	48	5	5	10	103	118,5	134	149,5	165	180,5	196	211,5
N40	88	48	7	6	12	134	152	170	188	206	224	242	260
N60	88	48	7	6	12	145,5	175	245,5	234	263,5	293	322,5	352
N80	88	48	7	6	12	145,5	175	245,5	234	263,5	293	322,5	352
N100	132	110	9	7	15	202	232	262	292	322	352	382	412
N200	132	110	9	7	15	212	252	292	332	372	412	452	492
L100	88	48	7	6	12	-	152	-	188	-	224	-	260
L160	88	48	7	6	12	145,5	175	245,5	234	263,5	293	322,5	352
L400	132	110	9	7	15	212	252	292	332	372	412	452	492
L600	132	110	9	7	15	-	-	292	-	-	412	-	-
L800	132	110	9	7	15	-	252	-	332	-	412	452	492
L1200	132	110	9	7	15	-	-	292	-	-	412	-	-

Key operated switches SA

Panel mounting E
M10 - N60

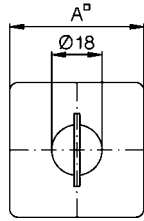
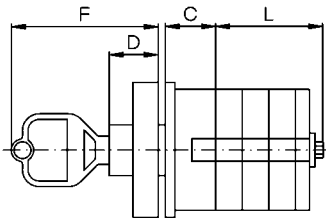

Mounting holes

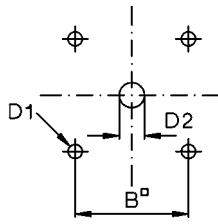

Base mounting V
M10 - N60

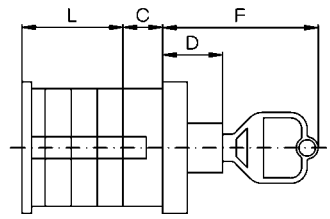
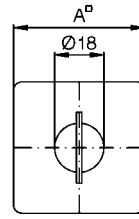

Type	A	B	C	D	D1	D2	F
M10H, M20	48	36	18	17,5	5	18,5	52,5
N20, N33F	64	48	10	17,5	5	18,5	52,5
N40, N60	88	68	23,5	15	6	18,5	50

Type	A	C	D	F
M10H, M20	48	18	22	57
N20, N33F	64	8	22	57
N40, N60	88	15	15	50

Dimension L see page 77

Dimension L see page 78

Central fixing Z
M10H Z ... + SA
M20 Z ... + SA

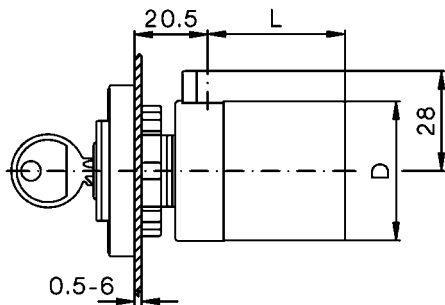

Central fixing without escutcheon plate ZO
M10H ZO ... + SA
M20 ZO ... + SA

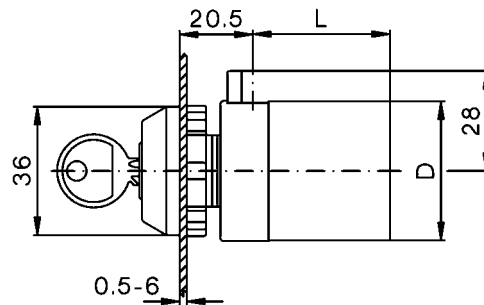

Mounting holes:

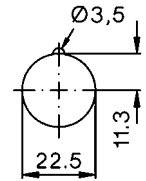

Further dimensions see page 77

DIN rail mounting SMA
M10H, M20

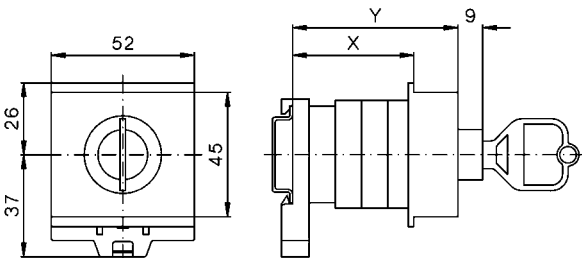

Type	Dimension X with .. cells				Dimension Y with .. cells			
	1	2	3	4	1	2	3	4
M10H	44	75	75	91	60	90	90	107
M20	59	75	75	91	75	90	90	107

Flush mounting UP
M10

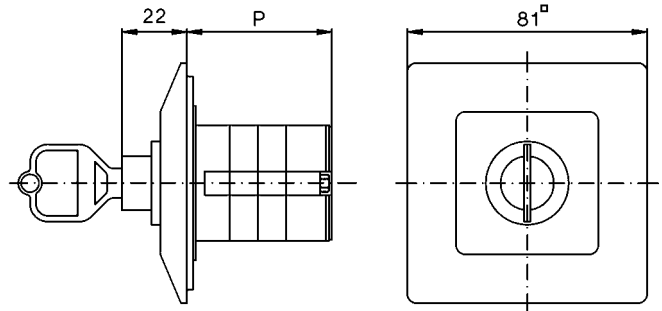

Type	Dimension P with .. cells	
Type	1	2
M10	47,5	57

Plastic enclosed switches P, PF
M10, N20, N33F, N40, N60

Type	Dimension P with .. cells			
	1	2	3	4
M10	62	71	81	90
N20	66	80	94	108
N33F	92	110	110	128
N40	92	110	-	-
N60	110	-	-	-

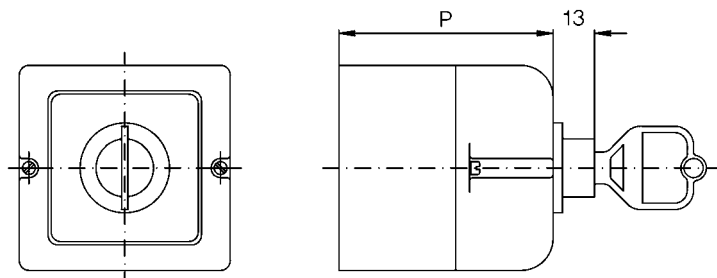

Further dimensions see page 79

Key operated switches

Key operated switch SAK
Panel mounting E M10H, M20

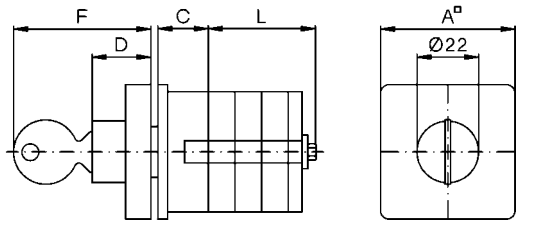

Type	A	B	C	D	D1	D2	F
M10H, M20	48	36	25	21	5	22,5	49

Mounting holes

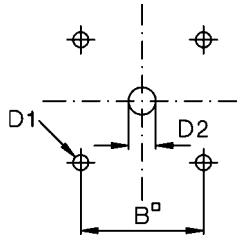

Key operated switch SAK
Base mounting V M10H, M20

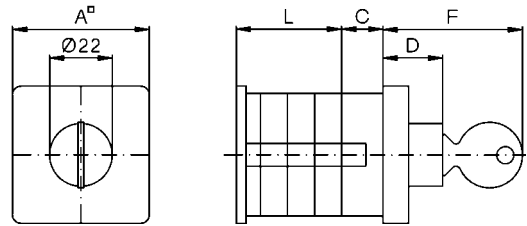

Type	A	C	D	F
M10H, M20	48	25	21	49

Key operated switch SASI
Panel mounting E M10, M20

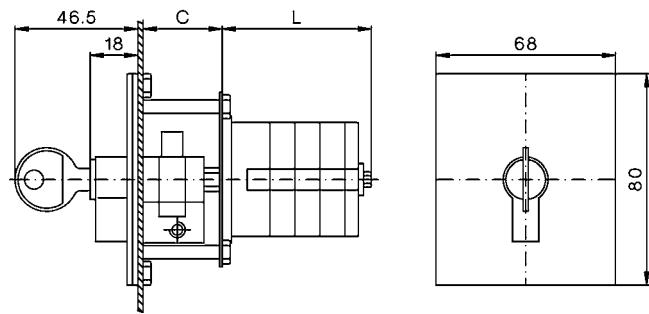

Type	M10	M20
C	20	20

Dimension L see page 77

Mounting holes M10, M20

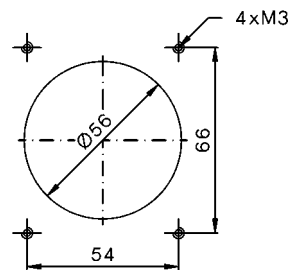

Key operated switch SASI
Plastic enclosed P M10, M20

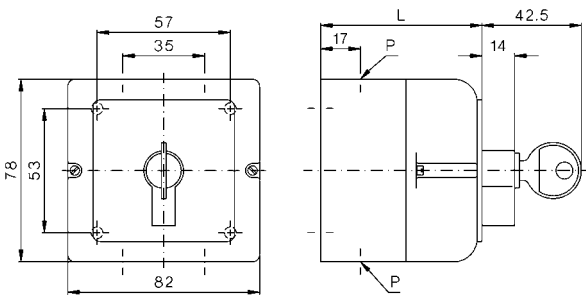

Typ	Dimension P with .. cells				P
	1	2	3	4	
M10	67	79,5	92	104,5	2xM20
M20	79,5	92	104,5	117	2xM20

Key operated switch SASI
Flush mounting UP M10, M20

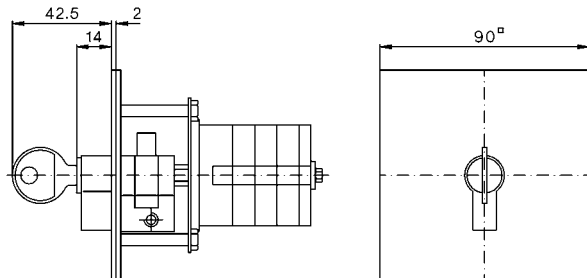

Flush mounting box UP
N20

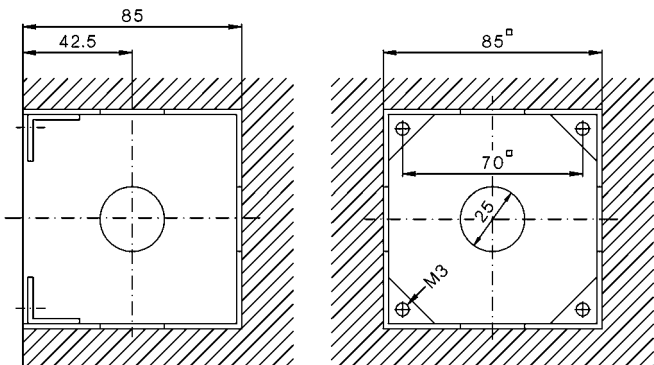

Padlock devices

Padlock device SV1 (max. 2 padlocks with stirrup $\varnothing 6\text{mm}$)
M10H, M20
Mounting holes design E, V

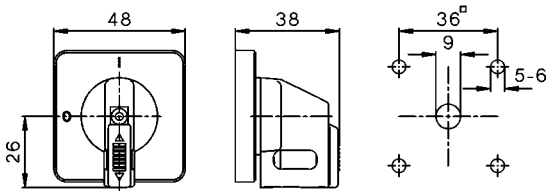

Padlock device SV164
M10H - N33F
Mounting holes design E, V

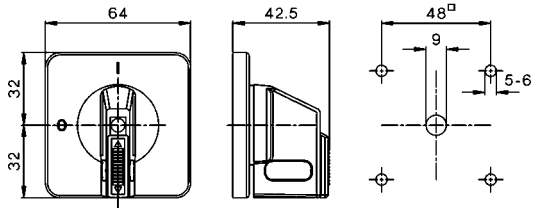

Padlock device SV3 (max. 3 padlocks with stirrup $\varnothing 8,5\text{mm}$)
Panel mounting E
N20 - N200, L100 - L1200

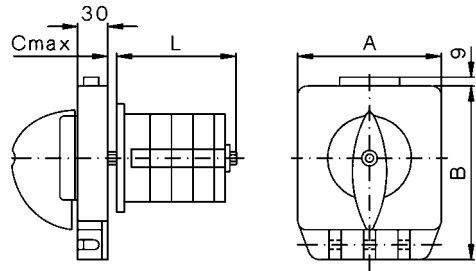

Base mounting V
N20 - N200, L100 - L1200

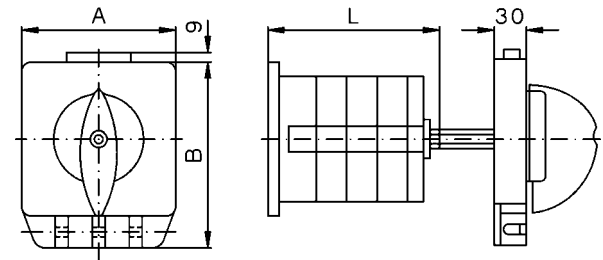

Further dimensions see page 77

Further dimensions see page 78

Type	A	B	C
N20, N33F	102	128	5
N40, N60, N80, L100, L160	102	128	7
N100, N200, L400, L600, L800, L1200	132	159	9

Padlock device SV4 (max. 3 padlocks with stirrup $\varnothing 6\text{mm}$)
M10H - N33F

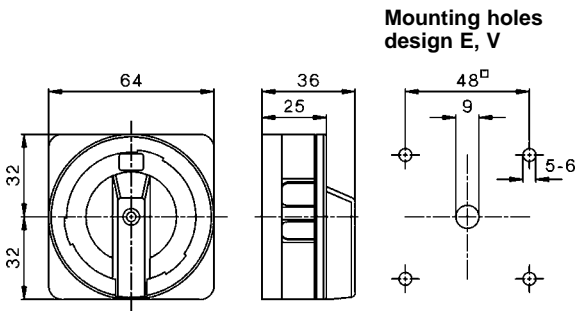

Padlock device SV4 (max. 3 padlocks with stirrup $\varnothing 6\text{mm}$)
N40 - N80, L100 - L160
Padlock device SV488
N20, N33F
Mounting holes design E, V

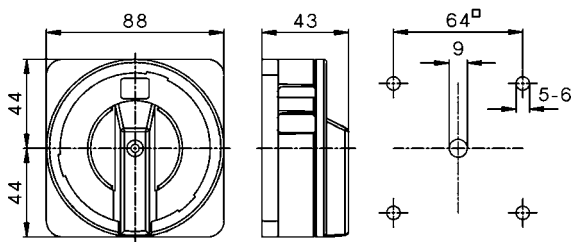

Front plate/switch shaft sealing FPWD
N20, N33F

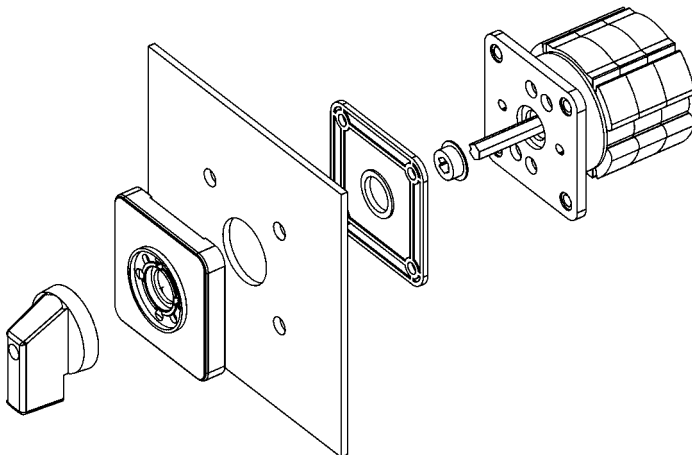

Mounting holes

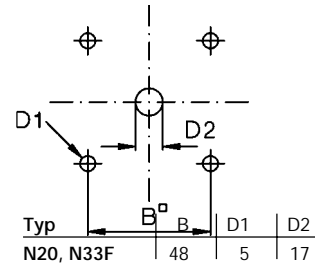

Interlocks

Lock switch SZ, SZ2 Panel mounting E

Base mounting V

Mounting holes

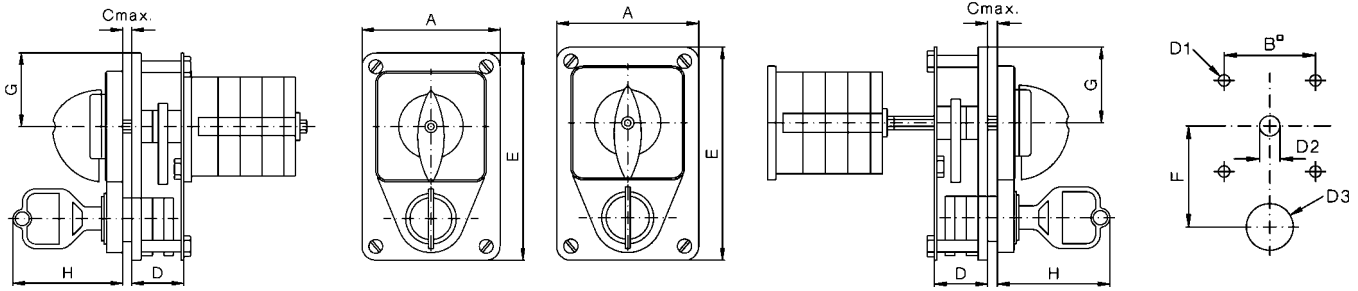

Type	A	B	C	D	D1	D2	D3	E	F	G	H
M10H, M20	60	36	3	22,5	5	8	18,5	90	40	32	47,5
N20, N33F	60	36	3	22,5	5	12	18,5	90	45	32	47,5
N40, N60, N80, L100, L160	90	68	4	24	6	12	18,5	142	61	61,5	48
N100, N200, L400, L600, L800, L1200	140	110	4	27	7	15	18,5	180	83	90,5	49

Push-button switch lock DV Switch interlock with electrical contact ET Panel mounting E

Base mounting V

Mounting holes

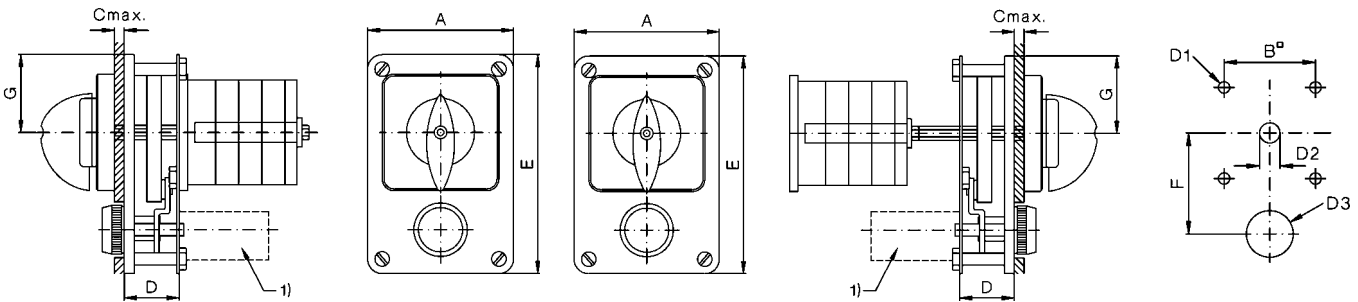

Type	A	B	C	D	D1	D2	D3	E	F	G
M10H, M20	60	36	3	22,5	5	8	26	90	40	32
N20, N33F	60	36	3	22,5	5	12	26	90	45	32
N40, N60, N80, L100, L160	90	68	4	25	6	12	29	142	61	61,5
N100, N200, L400, L600, L800, L1200	140	110	4	41	7	15	29	180	83	90,5

1) only at +ET

Moisture proofing caps for panel switches FR M10H

Type	Dimension L with ... cells						
	1	2	3	4	5	6	7
M10H	55	55	75	75	88	106	106

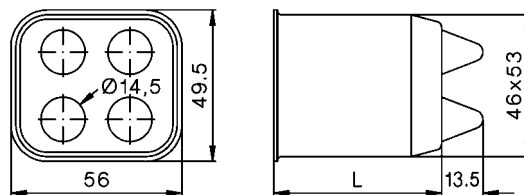

Moisture proofing caps for panel switches FR N20, N40, N60

Type	A	B	D	E	Dimension L with ... cells				
					1	2	3	4	5
N20	60	48	59	5,5	68	68	68	91	91
N40	87	68	83	5,5	82	82	117	117	-

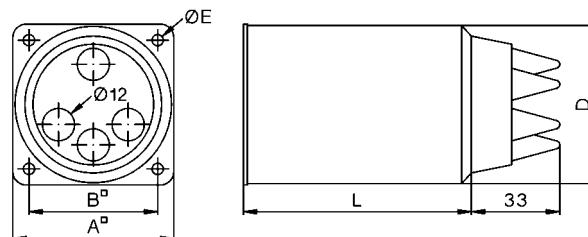

Interlocks

Geared switch with two columns ZK2
Panel mounting E

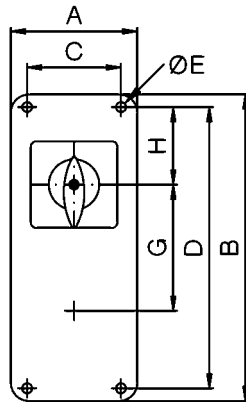
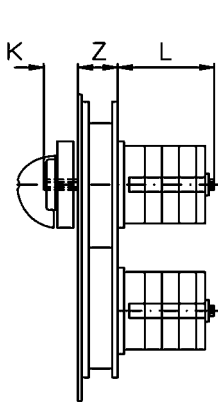

Base mounting V

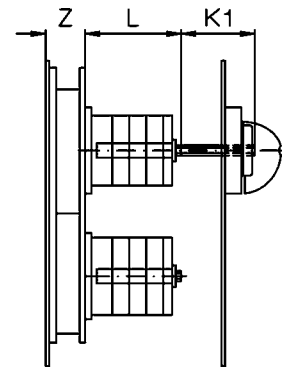
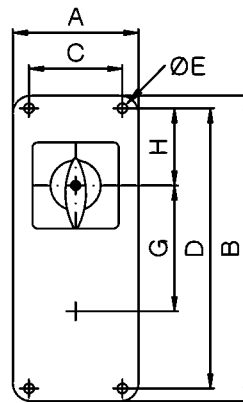

Type	A	B	C	D	E	G	H	Z
M10H, M20	70	170	52	156	5,5	70	43	22
N20, N33F	70	170	52	156	5,5	70	43	22
N40, N60, N80, L100, L160	170	190	150	168	6,5	100	43	23
N100, N200, L400, L600, L800, L1200	180	340	150	310	6,5	140	80	25

Further dimensions see pages 77 and 78

Geared switch with tree columns ZK3
Panel mounting E

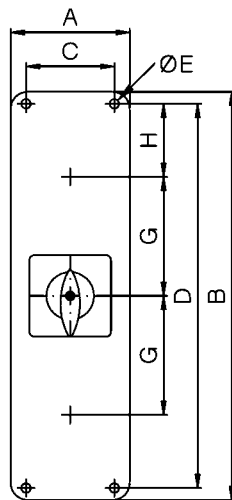
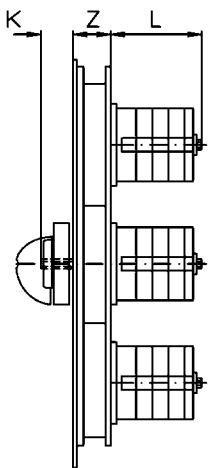

Base mounting V

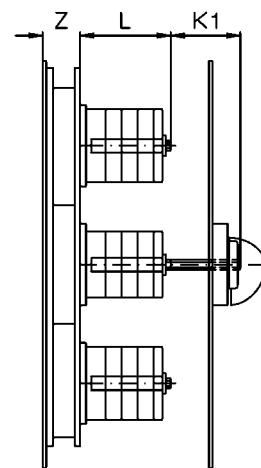
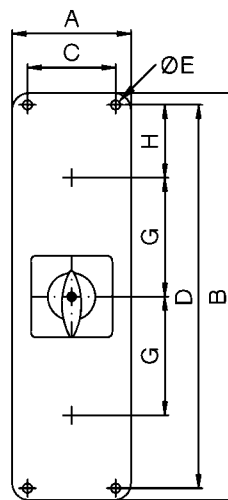

Type	A	B	C	D	E	G	H	Z
M10H, M20	70	240	52	226	5,5	70	43	22
N20, N33F	70	240	52	226	5,5	70	43	22
N40, N60, N80, L100, L160	170	290	150	269	6,5	100	43	23
N100, N200, L400, L600, L800, L1200	180	490	150	460	6,5	140	80	25

Further dimensions see pages 77 and 78

Neon safety switch N20 E .. +FEU, N33F E .. +FEU

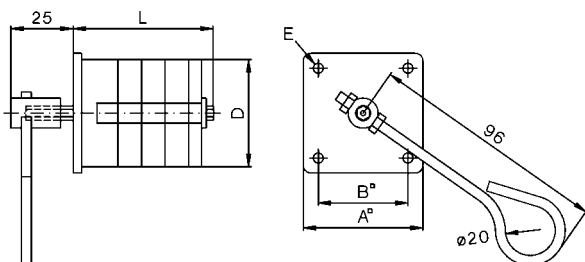

Door contact, 2-pole BK

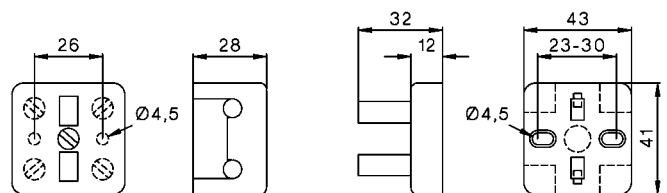

Further dimensions see pages 77