

GF4C ROTARY LIMIT SWITCH

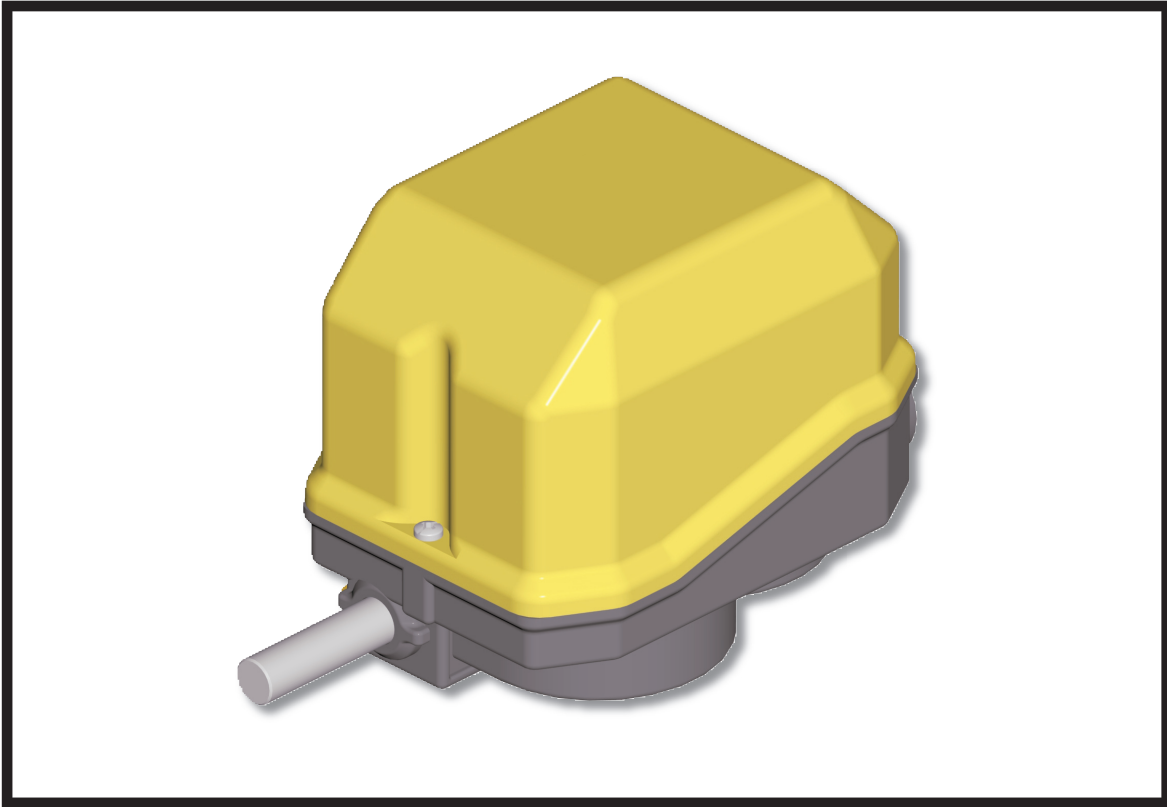

— The rotary limit switch is used to control the movement of industrial machinery. It operates as an auxiliary controller of electrical motors through a power interface, such as a contactor or PLC. Suitable for heavy duty, its shaft is connected to the motor and, after a set number of revolutions, the cams operate the switches, thus starting the predetermined movement. A worm gear and a helical toothed gear combined with one or more pairs of straight toothed gears are used for the transmission of the movement from the input shaft to the output shaft.

— Revolution ratios, ranging from 1:1 to 1:969, result from the use of different combinations of gear wheels between the input shaft and the output shaft, which is connected to the cams operating the switches.

Transmission and gear driving shafts are made of stainless steel to prevent oxidation and wear. The gear wheels and the driving bushes are made of self-lubricating thermoplastic material, suitably chosen to reduce the wear to a minimum and to maintain the accuracy of the couplings over time. Sintered bronze bushes are moulded into the base of the limit switch to optimise the shaft rotation and to prevent rubbing with plastic material.

— Each cam can be set with great accuracy thanks to the cam adjusting screws. The auxiliary switches are of a positive opening type, thus suitable for safety functions. It is available with direct control switches for operating directly on the motor.

The cam-switch sets can be substituted for potentiometers suitable for the connection to electronic equipment. Each output of the limit switch can be set with a different revolution ratio to allow for a diversified control of the machinery to meet special requirements.

— Materials and components are wear resistant and protect the equipment against water and dust. The limit switch is available with a flange for direct coupling to the motor and it can be customised with labels and colours according to the customer's requirements.

GF4C ROTARY LIMIT SWITCH



GF4C ROTARY LIMIT SWITCH

TECHNICAL SPECIFICATIONS

Conformity to Community Directives	73/23/CEE 93/68/CEE
Conformity to Standards	EN 60204-1 EN 60947-1 EN60947-5-1 EN 60529 EN 50013 IEC 536
Ambient temperature	Storage -40°C/+70°C Operational -25°C/+70°C
Protection degree	IP 65
Insulation category	Class II
Cable entry	Cable clamp M20
Homologations	CE (UL - (c)UL limit switches available on request)

TECHNICAL SPECIFICATIONS OF THE SWITCHES

Utilisation category	AC 15
Rated operational current	3 A
Rated operational voltage	250 V
Rated thermal current	10 A
Rated insulation voltage	300 V~
Mechanical life	1x10 ⁶ operations
Terminal referencing	According to EN 50013
Connections	Screw-type terminals with self-lifting pads
Homologations	CE - UL - (c)UL

STANDARD LIMIT SWITCH CODES

REVOLUTION RATIO	TYPE OF CONTACT	2 SWITCHES	3 SWITCHES	4 SWITCHES
1:1	Snap	PF0903 0001 0003	PF0903 0001 0002	PF0903 0001 0001
	Slow	PF0903 0001 0004	PF0903 0001 0005	PF0903 0001 0006
1:5	Snap	PF0903 0005 0002	PF0903 0005 0003	PF0903 0005 0001
	Slow	PF0903 0005 0004	PF0903 0005 0005	PF0903 0005 0006
1:10	Snap	PF0903 0010 0003	PF0903 0010 0004	PF0903 0010 0002
	Slow	PF0903 0010 0005	PF0903 0010 0006	PF0903 0010 0007
1:15	Snap	PF0903 0015 0004	PF0903 0015 0003	PF0903 0015 0002
	Slow	PF0903 0015 0007	PF0903 0015 0008	PF0903 0015 0001
1:20	Snap	PF0903 0020 0002	PF0903 0020 0003	PF0903 0020 0001
	Slow	PF0903 0020 0004	PF0903 0020 0005	PF0903 0020 0006
1:25	Snap	PF0903 0025 0006	PF0903 0025 0003	PF0903 0025 0001
	Slow	PF0903 0025 0007	PF0903 0025 0008	PF0903 0025 0002
1:50	Snap	PF0903 0050 0002	PF0903 0050 0003	PF0903 0050 0006
	Slow	PF0903 0050 0028	PF0903 0050 0017	PF0903 0050 0007
1:75	Snap	PF0903 0075 0007	PF0903 0075 0008	PF0903 0075 0004
	Slow	PF0903 0075 0009	PF0903 0075 0010	PF0903 0075 0006
1:100	Snap	PF0903 0100 0002	PF0903 0100 0006	PF0903 0100 0003
	Slow	PF0903 0100 0001	PF0903 0100 0013	PF0903 0100 0004
1:150	Snap	PF0903 0150 0002	PF0903 0150 0011	PF0903 0150 0008
	Slow	PF0903 0150 0001	PF0903 0150 0009	PF0903 0150 0003
1:200	Snap	PF0903 0200 0006	PF0903 0200 0002	PF0903 0200 0003
	Slow	PF0903 0200 0007	PF0903 0200 0004	PF0903 0200 0008
1:250	Snap	PF0903 0250 0003	PF0903 0250 0007	PF0903 0250 0008
	Slow	PF0903 0250 0009	PF0903 0250 0010	PF0903 0250 0011
1:300	Snap	PF0903 0300 0004	PF0903 0300 0006	PF0903 0300 0007
	Slow	PF0903 0300 0008	PF0903 0300 0009	PF0903 0300 0010

Standard limit switches are equipped with 2,3 or 4 snap or slow action switches and with pointed cams PRSL7140PI. Other assemblies and revolution ratios are available on request. It is possible to assemble up to 6 switches. Maximum revolution ratio 1:969.

GF4C ROTARY LIMIT SWITCH

OVERALL DIMENSIONS

STANDARD LIMIT SWITCH

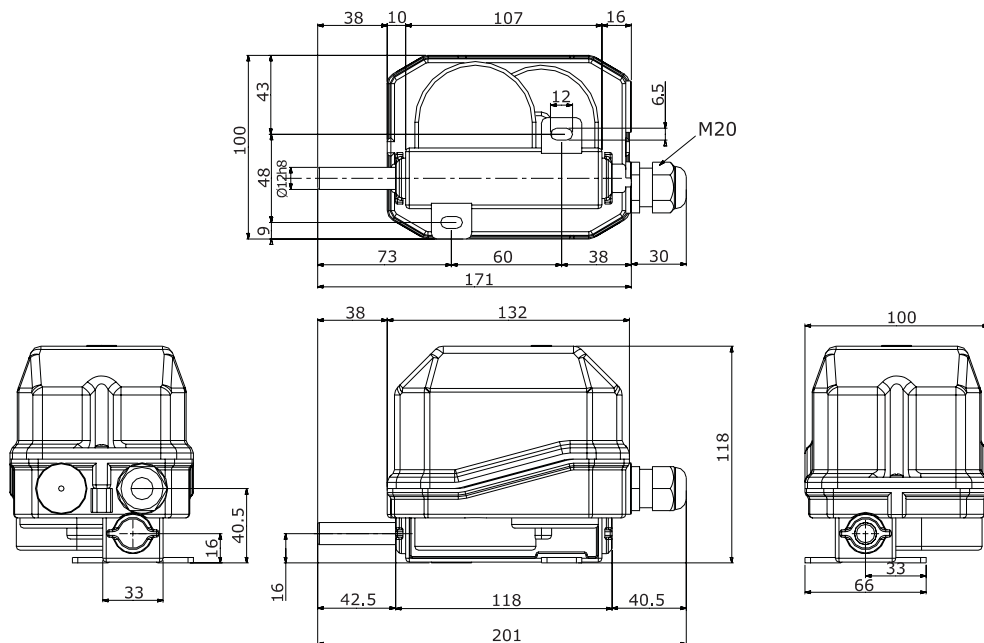

LIMIT SWITCH WITH FLANGE

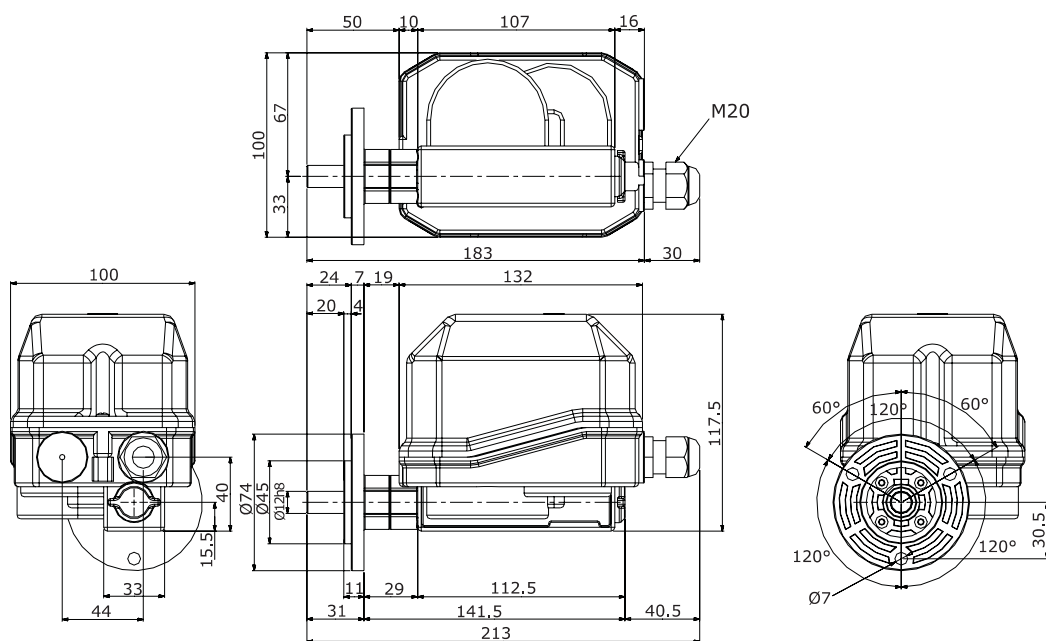

GF4C ROTARY LIMIT SWITCH



GF4C ROTARY LIMIT SWITCH





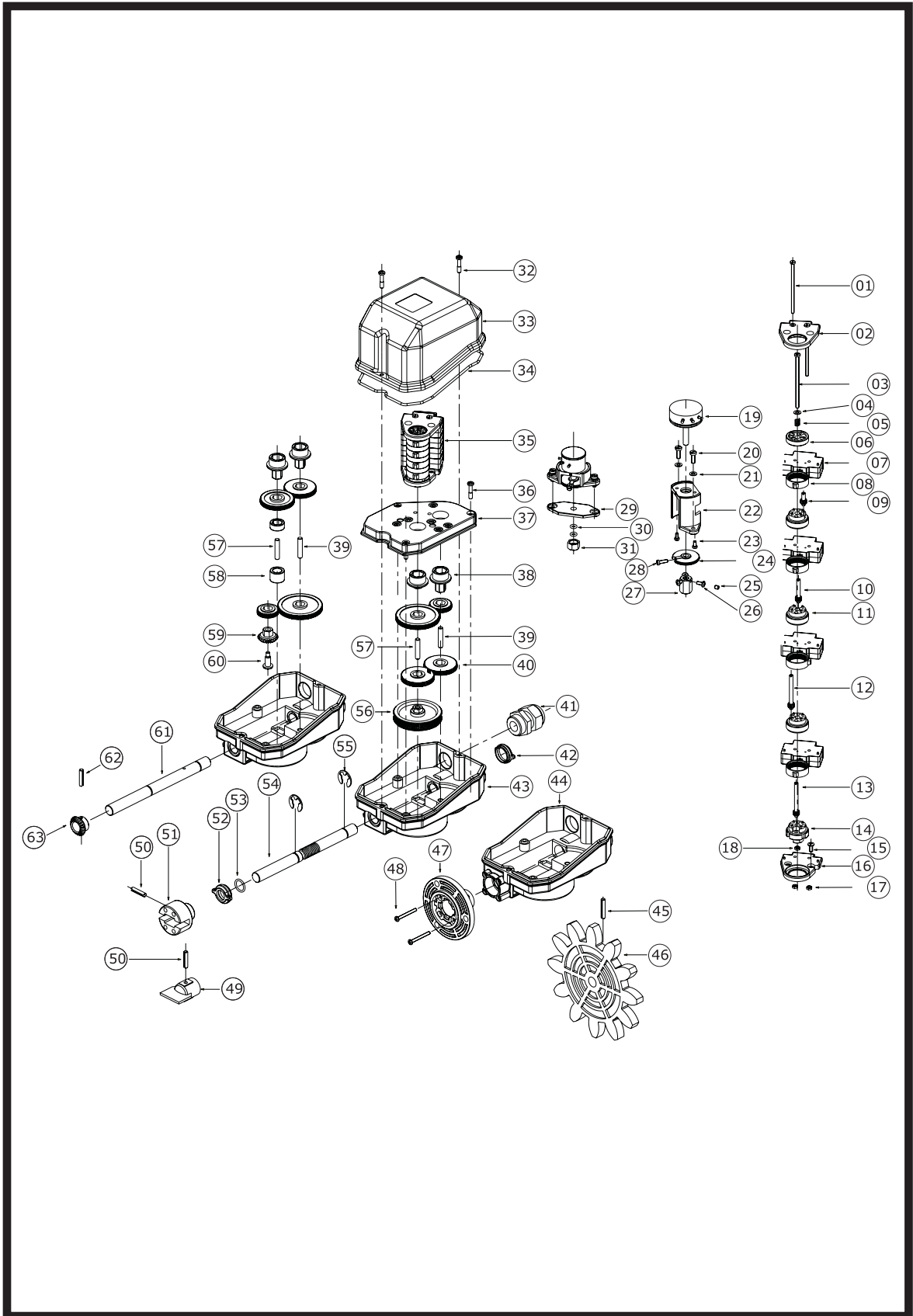







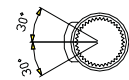
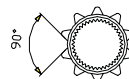
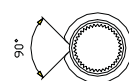

DETAILED DRAWING

GF4C ROTARY LIMIT SWITCH

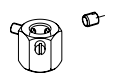
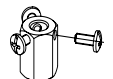
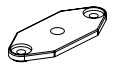

GF4C ROTARY LIMIT SWITCH

SPARE PARTS

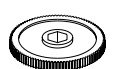





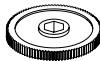

REFERENCE	DRAWING	CODE	DESCRIPTION
07		PRSL0036XX PRSL0037XX	Snap action switch Slow action switch
08		PRSL7140PI	Pointed cam
08		PRSL7141PI	Sector cam
08		PRSL7142PI	10 point cam
08		PRSL7143PI	Circular cam
08		PRSL7144PI	180° cam
19		PRVV9020PE PRVV9025PE PRVV9035PE	Potentiometer Megatron 4.7 kW with continuous rotation Potentiometer Megatron 10 kW with continuous rotation Potentiometer Megatron 2.2 kW with continuous rotation
19		PRVV9030PE PRVV9031PE	Potentiometer MCB 10 kΩ Potentiometer MCB 10 kΩ with continuous rotation
22 +20+21		PRSL0928PI	Small support for potentiometer with O-ring
22 +20+21		PRSL0929PI	Large support for potentiometer
22 +20+21		PRSL0930PI	Medium support for potentiometer
22 +20+21		PRSL0931PI	Medium support for potentiometer
24 +28		PRSL0909PI	Adjusting gear
27 +26		PRSL0932PI	Fixed coupling for potentiometer 33mm
27 +25		PRSL0933PI	Fixed coupling for potentiometer 13mm
27 +26		PRSL0934PI	Fixed coupling for potentiometer 17mm
29		PRSL9409PI	Support plate for potentiometer with O-ring
31 +30		PRSL0927PI	Bush for potentiometer
40		PRSL6598PI PRSL6599PI PRSL6600PI PRSL6601PI PRSL6602PI	Lateral gear wheel Z 35 Lateral gear wheel Z 37 Lateral gear wheel Z 36 Lateral gear wheel Z 38 Lateral gear wheel Z 40

GF4C ROTARY LIMIT SWITCH

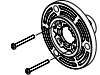

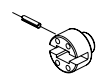













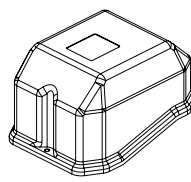
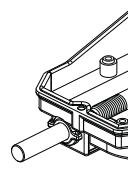

GF4C ROTARY LIMIT SWITCH

SPARE PARTS

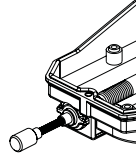
REFERENCE	DRAWING	CODE	DESCRIPTION
40		PRSL6603PI	Lateral gear wheel Z 42
		PRSL6604PI	Lateral gear wheel Z 44
		PRSL6605PI	Lateral gear wheel Z 46
		PRSL6606PI	Lateral gear wheel Z 48
		PRSL6607PI	Lateral gear wheel Z 50
		PRSL6608PI	Lateral gear wheel Z 52
		PRSL6609PI	Lateral gear wheel Z 54
		PRSL6611PI	Lateral gear wheel Z 56
		PRSL6612PI	Lateral gear wheel Z 58
		PRSL6613PI	Lateral gear wheel Z 60
		PRSL6614PI	Lateral gear wheel Z 62
		PRSL6615PI	Lateral gear wheel Z 64
		PRSL6616PI	Lateral gear wheel Z 66
		PRSL6617PI	Lateral gear wheel Z 68
		PRSL6618PI	Lateral gear wheel Z 70
		PRSL6619PI	Lateral gear wheel Z 72
		PRSL6620PI	Lateral gear wheel Z 74
		PRSL6621PI	Lateral gear wheel Z 76
		PRSL6622PI	Lateral gear wheel Z 78
		PRSL6623PI	Lateral gear wheel Z 80
		PRSL6624PI	Lateral gear wheel Z 82
		PRSL6625PI	Lateral gear wheel Z 84
		PRSL6626PI	Lateral gear wheel Z 86
		PRSL6627PI	Lateral gear wheel Z 88
		PRSL6628PI	Lateral gear wheel Z 90
		PRSL6629PI	Lateral gear wheel Z 92
		PRSL6630PI	Lateral gear wheel Z 94
		PRSL6631PI	Lateral gear wheel Z 96
		PRSL6632PI	Lateral gear wheel Z 98
		PRSL6633PI	Lateral gear wheel Z 100
PRSL6634PI	Lateral gear wheel Z 102		
PRSL6635PI	Lateral gear wheel Z 104		
PRSL6636PI	Lateral gear wheel Z 106		
PRSL6637PI	Lateral gear wheel Z 108		
PRSL6638PI	Lateral gear wheel Z 107		
PRSL6639PI	Lateral gear wheel Z 109		
46 +45		PRSL0911PI	Pinion gear M10 Z12
		PRSL0912PI	Pinion gear M12 Z10
		PRSL0913PI	Pinion gear M14 Z10
		PRSL0914PI	Pinion gear M16 Z10
		PRSL0915PI	Pinion gear M20 Z8
		PRSL0916PI	Pinion gear M5 Z12
		PRSL0917PI	Pinion gear M6 Z11
		PRSL0918PI	Pinion gear M8 Z12
PRSL0944PI	Pinion gear M12 Z12		
47 +48		PRSL0947PI	Flange
49 +50		PRSL0919PI	Male coupling
51 +50		PRSL0920PI	Female coupling
54		PRT00065PE	Single-thread worm shaft
		PRT00054PE	Double-thread worm shaft
54		PRT00076PE	Flexible shaft
56		PRSL6703PI	Central gear wheel Z 100

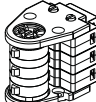
GF4C ROTARY LIMIT SWITCH

REQUEST FORM FOR NON STANDARD LIMIT SWITCHES

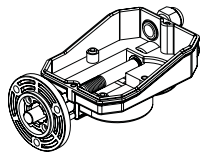
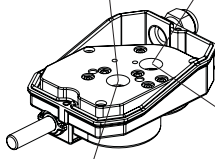
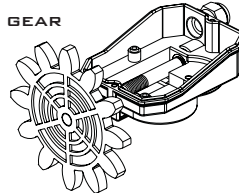
<p>CAMS</p> <p>1  PRSL7140PI</p> <p>2  PRSL7141PI</p> <p>3  PRSL7142PI</p> <p>4  PRSL7143PI</p> <p>5  PRSL7144PI</p>	<p>POTENTIOMETER</p> <p> <input type="checkbox"/> <input type="checkbox"/></p> <p>O-RING COUPLING</p> <p> <input type="checkbox"/> <input type="checkbox"/></p> <p>FIXED COUPLING</p> <p> <input type="checkbox"/> <input type="checkbox"/></p>	<p>COVER</p> <p><input type="checkbox"/> </p> <hr/> <p>STANDARD SHAFT</p> <p><input type="checkbox"/> </p>	
<p>SWITCHES</p> <p>1 PRSL0036XX Snap action</p> <p>2 PRSL0037XX Slow action</p>	<p> <input type="checkbox"/> <input type="checkbox"/> <input type="checkbox"/> <input type="checkbox"/></p> <p style="text-align: center;">CAMS SWITCHES CAMS SWITCHES</p>	<p>FLEXIBLE SHAFT</p> <p><input type="checkbox"/> </p>	
<p>POTENTIOMETERS</p> <p>1 PRVV9020PE Megatron 4.7 kΩ continuous rotation</p> <p>2 PRVV9025PE Megatron 10 kΩ continuous rotation</p> <p>3 PRVV9035PE Megatron 2.2 kΩ continuous rotation</p> <p>4 PRVV9030PE MCB 10 kΩ</p> <p>5 PRVV9031PE MCB 10 kΩ continuous rotation</p>	<p> <input type="checkbox"/> <input type="checkbox"/> <input type="checkbox"/> <input type="checkbox"/></p> <p> <input type="checkbox"/> <input type="checkbox"/> <input type="checkbox"/> <input type="checkbox"/></p> <p> <input type="checkbox"/> <input type="checkbox"/> <input type="checkbox"/> <input type="checkbox"/></p>	<p>PINION GEARS</p> <p>1 PRSL0911PI M10 Z12</p> <p>2 PRSL0912PI M12 Z10</p> <p>3 PRSL0913PI M14 Z10</p> <p>4 PRSL0914PI M16 Z10</p> <p>5 PRSL0915PI M20 Z8</p> <p>6 PRSL0916PI M5 Z12</p> <p>7 PRSL0917PI M6 Z11</p> <p>8 PRSL0918PI M8 Z12</p> <p>9 PRSL0944PI M12 Z12</p>	
<p>MALE COUPLING</p> <p><input type="checkbox"/> </p> <p>FEMALE COUPLING</p> <p><input type="checkbox"/> </p> <p>FLANGE</p> <p><input type="checkbox"/> </p>	<p>REVOLUTION RATIO</p> <p></p> <p><input type="text"/> <input type="text"/></p>	<p>PINION GEAR</p> <p><input type="checkbox"/> </p>	
<p>INSTRUCTIONS</p> <ul style="list-style-type: none"> - Mark the boxes corresponding to the components required. - Write the numbers corresponding to the cams, the switches, the pinion gear and the potentiometers required. - When a potentiometer is required, mark the box corresponding to the type of coupling needed. - Write the revolution ratio required for each output. 			
<p>REMARKS</p> <p>_____</p> <p>_____</p> <p>_____</p> <p>_____</p> <p>_____</p> <p>_____</p> <p>_____</p> <p>_____</p>			

GF4C ROTARY LIMIT SWITCH



GF4C ROTARY LIMIT SWITCH

USE AND MAINTENANCE INSTRUCTIONS

The GF4C rotary limit switch is an electromechanical device for low voltage control circuits (EN 60947-1, EN 60947-5-1) to be used as electrical equipment on machines (EN 60204-1) in compliance with the fundamental requirements of the Low Voltage Directive 73/23/CEE and of the Machine Directive 89/392/CEE.

The limit switch is designed for industrial use and also for use under particularly severe climatic conditions (operational temperature from -25°C to $+70^{\circ}\text{C}$, suitable for use in tropical environment). The equipment is not suitable for use in environments with potentially explosive atmosphere, corrosive agents or a high percentage of sodium chloride (saline fog). Oils, acids or solvents may damage the equipment. Use the fixing holes on the base or the flange (47) to mount the limit switch. The use of special couplings (49, 51), flexible shafts or special driving systems (not supplied) are recommended for eliminating any misalignment between the limit switch shaft (54, 61) and the reduction gear shaft to which it is connected. After loosening the central screw (03) use the screws (09, 10, 12, 13) to adjust the operating point of the cams (08); once the cams are adjusted, tighten the central screw (03).

The switches (07) are designed for auxiliary control of contactors or electromagnetic loads (utilisation category AC-15 according to EN 60947-5-1). The switches (07) have positive opening operation contacts (EN 60947-5-1). Do not connect more than one phase to each switch (07). Do not oil or grease the control elements (08) or the switches (07). For easy wiring, the set of cams/switches (35) may be removed by loosening the screws (15) on the lower fixing plate; do not loosen the screws (01) on the upper part of the set of cams/switches in order not to take apart the switches; after wiring is completed, the set of cams/switches (35) must be properly fixed and screwed, paying attention to the coupling of the hexagonal plastic bushes (14, 38).

The installation of the limit switch shall be carried out by an expert and trained personnel. Wiring shall be properly done according to the current instructions.

Prior to the installation and the maintenance of the limit switch, the main power of the machinery shall be turned off.

Steps for the proper installation of the limit switch

- loosen the fixing screw (32) and remove the cover (33)
- connect the limit switch shaft (54, 61) to the reduction gear shaft; to avoid any misalignment between the two shafts the use of couplings (49, 51), flexible shafts or special driving systems is recommended
- fix the limit switch firmly in place to prevent abnormal vibrations of the equipment during operation; use only the fixing holes on the base or the flange (47) to fix the equipment
- insert the cable into the limit switch through the cable clamp (41)
- strip the cable to a length suitable for wiring the switches (07)
- tape the stripped part of the cable
- clamp the wire into the cable clamp (41)
- connect all the switches (07) according to the contact scheme printed on the switches (tighten the wires into the terminals with a torque equal to 0.8 Nm; insertability of wires into the switch terminals equal to $2 \times 1.5 \text{ mm}^2 - 1 \times 2.5 \text{ mm}^2$)
- adjust the operating point of the cams (08); for proper adjustment, loosen the central screw (03) of the cam set, adjust the operating point of each single cam (08) by turning its screw (09, 10, 12, 13) (the numbers on the screws refer to the cams counting from bottom to top), then tighten the central screw (03)
- close the limit switch checking the proper positioning of the rubber (34) in the cover (33)

Periodic maintenance steps

- check the proper tightening of the screws (32) and cover (33)
- check the proper tightening of the switch (07) terminal screws
- check the proper tightening of the central screw (03) holding the cams (08)
- check the wiring conditions (in particular where wires clamp into the switch)
- check the proper positioning of the front (52) and rear (42) bush covers
- check the conditions of the rubber (34) fit into the cover (33) and check the tightening of the cable clamp (41) around the cable
- check that the limit switch enclosure (33, 43, 44) is not broken
- check the alignment between the limit switch shaft (54, 61) and the reduction gear shaft
- check that the limit switch is properly fixed

In case any component of the limit switch is modified, the validity of the markings and the guarantee on the equipment are annulled. Should any component need replacement, use original spare parts only.

TER declines all responsibility for damages caused by the improper use or installation of the equipment.

GF4C ROTARY LIMIT SWITCH

