

## 2"1/2 (ND65) MEGA SUPERVENTIX flanged safety relief valve - MX65

2"1/2 MEGA SUPERVENTIX<sup>TM</sup> flanged safety relief valve - designed to protect tanks against accidental overpressure or excessive vacuum.

With a smart compact design, the 2"1/2 MEGA SUPERVENTIX<sup>TM</sup> has a high flow performance.



### Specifications

Nominal diameter	(2"1/2)
Weight	3.2 Kg
Drilling	4 slotted holes x Ø18 on a 145 to 152.4 PCD
Standard pressure settings	4.40 / 7.33
Standard vacuum settings	0.21 Bar
Working Temperature	-40° to +190°C

### Features

Made of (material)	316 / 1.4408 stainless steel
Seals material	FEP
O'ring material	FEP silicone / PFA silicone/ Viton / Nitrile / Foodstuff Nitrile

### Conformity & certifications

Comply with	ADR / IMDG / RID / ISO4126-1
Certified flow rate witnessed by Bureau Veritas	

### Flow rates

Set Pressure			Measured flow rate at 120 % without gauze		Certified flow rate with the federal Register coefficient 90% without gauze	
Bar	KPa	PSIG	Sm <sup>3</sup> /s	Scfm	Sm <sup>3</sup> /s	Scfm
+/- 0.14	+/- 14	+/- 2				
2,18	218	31,6	2,560	5425	2,304	4883
3,75	375	54,4	3,918	8301	3,526	7471
4,40	440	63,8	4,480	9492	4,032	8544
7,33	733	107,3	6,987	14803	6,288	13324

Flow measurement conditions: 101.3 kPa at 15°C

### Options

Vacuum	with or without
Custom pressure and/or vacuum settings	on request
HALAR coating (body & springs) & poppet in Hastelloy	with or without
Gauze filter	with or without
1/4" gauge connection	with or without
Test button	with or without
Gauge protection	with or without
Complying with PED CE97/23 (Press. Equipment Directive)	Serie MP65 relief valve
Custom marking	on request

### Accessories

Weld-in flange	12 92 03 00 00
Recess flange	11 90 63 00 00
Seal	12 92 04 00 00
Screw kit	17 12 12 91 00
Pressure gauge	70 18 06 00 95

### Drawing

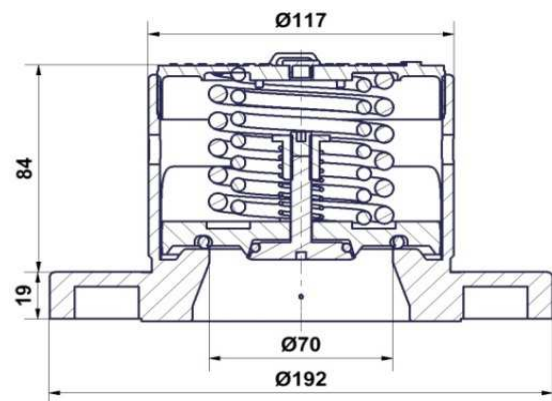

## 2"1/2 (ND65) MEGA SUPERVENTIX flanged safety relief valve - MX65

### CODIFICATION

1. Base code **MX65** ? ? ? ? ? ? ?

2. Body drilling

4 slots x Ø18 x 145-152.4 PCD  
with 1/4" BSP connection  
4 slots x Ø18 x 145-152.4 PCD  
with 1/4" BSP connection and plug

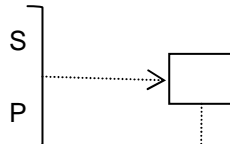

3. Set pressure

2.18 Bar  
3.75 Bar  
4.40 Bar  
7.33 Bar  
Other on request

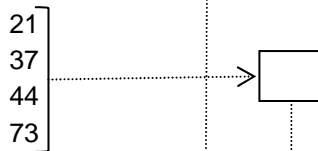

4. Seal type pressure/vacuum

FEP

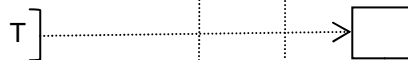

5. Vacuum (optional)

0.21 Bar  
0.05 Bar  
Other on request

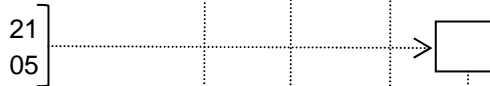

6. Flame proof gauze

With  
Without

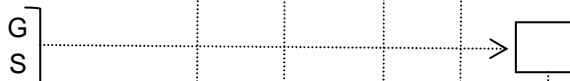

7. Vacuum test button (optional)

With  
Without

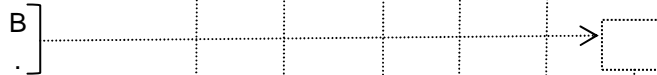

8. HALAR coating (optional)

With HALAR coating  
Without

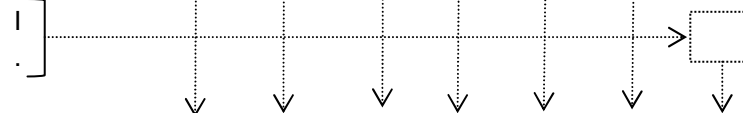

Standard Part Number

**MX65** **S** **44** **T** **S**

Your custom part number

**MX65** \_ \_ \_ \_ \_