



**R-NET INPUT/OUTPUT
MODULE**

TECHNICAL MANUAL

SK78814/I

© PG Drives Technology 2006

All rights reserved.

This manual is furnished under copyright and may only be used in accordance with the terms laid out by PG Drives Technology.

The information in this manual is furnished for informational use only, is subject to change without notice, and should not be construed as a commitment by PG Drives Technology.

Except as permitted by such terms, no part of this manual may be reproduced, stored in a retrieval system, or transmitted, in any form or by any means electronic, mechanical, recording, or otherwise - without the prior written permission of PG Drives Technology. +44 (0)1425 271444

Table of Contents

About this manual	5
Chapter I - Installation	7
1 Introduction	9
1.1 Input Setup	9
1.2 Output Setup	10
2 Dimensions	11
3 Mounting	11
3.1 Orientation	12
3.2 Position	12
3.3 Cables	12
4 Connections	13
4.1 On/Off Jack	13
4.2 Communications Connectors	14
5 Configuration	14
5.1 Switch Position Definitions	15
5.2 Input Functions	15
5.2.1 Switch Function	15
5.2.2 Proportional Function	15
5.3 Output Functions	16
5.3.1 Four-way Control	16
5.3.2 Diagonal Control	16
6 Global Inhibits	17
7 Specifications	17
7.1 9-way D Type (INPUT) Pin-out	17
7.2 Analog Signal Levels	17
7.2.1 Pin 1 - Joystick speed	18
7.2.2 Pin 2 - Joystick direction	18
7.2.3 Pin 3 - Joystick reference	18
7.2.4 Pin 5 - Detect	19
7.2.5 Pins 7 and 9 - 12V 100mA	19
7.2.6 Pin 8 - Joystick ground	19
7.3 Digital Signal Levels	19
7.3.1 Pins 1,2,3 and 4 - Direction	19
7.3.2 Pin 6 - Fifth Switch	19
7.3.3 Pins 7 and 9 - 12V 100mA	19
7.3.4 Pin 8 - 0V	19
7.4 On/Off Jack Socket	19
7.4.1 Signal levels	19

7.5	9-way D Type (OUTPUT) Pin-out	20
Chapter 2 – Programming.....		21
1	Introduction.....	23
2	Configuration	23
3	IOM Specific Programming	24
3.1	Input Module – Input Type	24
3.2	Output Module.....	24
3.2.1	Output Switching.....	24
3.2.2	Horn Operation	24

About this manual

The Technical Manual gives an introduction to the R-net Input/Output Module (IOM).

Throughout the manual icons are used to draw the reader's attention.

The icons used are:



Note - A general point for best practice.



Caution - A point of safety which if ignored could result in damage to the Control System or the vehicle.



Warning - A point of safety which if ignored could cause injury to the individual.

PG Drives Technology accept no liability for any losses of any kind if the points are not followed.



CHAPTER I - INSTALLATION

I Introduction

The R-net IOM is a universal module that can be used as either an Input Device interface or an Output Device in any R-net system. Typically, if being used as an input module the IOM will be used in conjunction with an R-net JSM.

The input connector is wired to the industry standard TRACE protocol and can be programmed to accept switched or proportional signals, making the IOM an ideal interface for switched head controls or mini-joysticks.

A jack socket is also included for connection to an On/off switch, such as a TASH Buddy Button.

The output connector is also wired to the TRACE protocol and provides all the functionality of the existing PGDT ACM, or ECU's supplied by other manufacturers. The output can be programmed for four directional control and diagonal control. There are also output pins corresponding to other buttons/controls on the Joystick Module, meaning functions such as full PC mouse control can be emulated.

Multiple IOM's can be connected into any R-net system. One IOM can be used to support an Environmental Control Module (Output) whilst at the same time a separate IOM can be used to control a Head Array or Mini Joystick (Input).

All output pins are isolated relay types and close to a common pin.



Operation of the R-net Control System will vary depending on what Input Devices are connected. Refer to wheelchair manufacturer's documentation to establish the correct setup requirements for the wheelchair.

II Input Setup

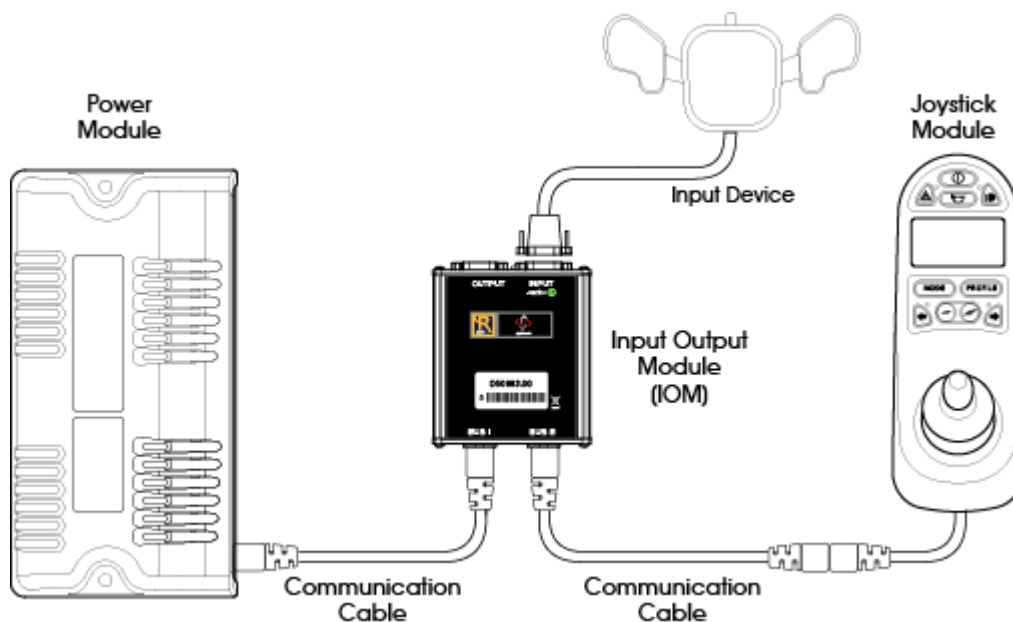

I.2 Output Setup

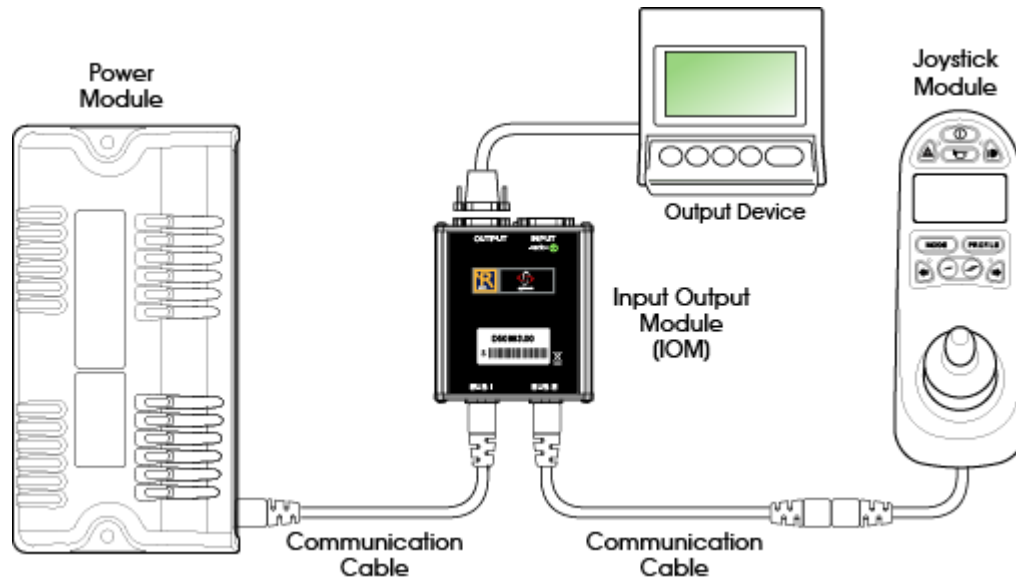

It is possible to set up a Control System so that it is unsuitable for some users or even some vehicles. For all of the above reasons it is important that you contact PG Drives Technology if you have the slightest doubts or if you need any advice on programming.



Programming and diagnostics should only be conducted by healthcare professionals with in-depth knowledge of PG Drives Technology electronic Control Systems. Incorrect programming could result in an unsafe setup of a vehicle for a user. PG Drives Technology accept no liability for any losses of any kind if the programming of the Control System is altered from the factory preset values.

2 Dimensions

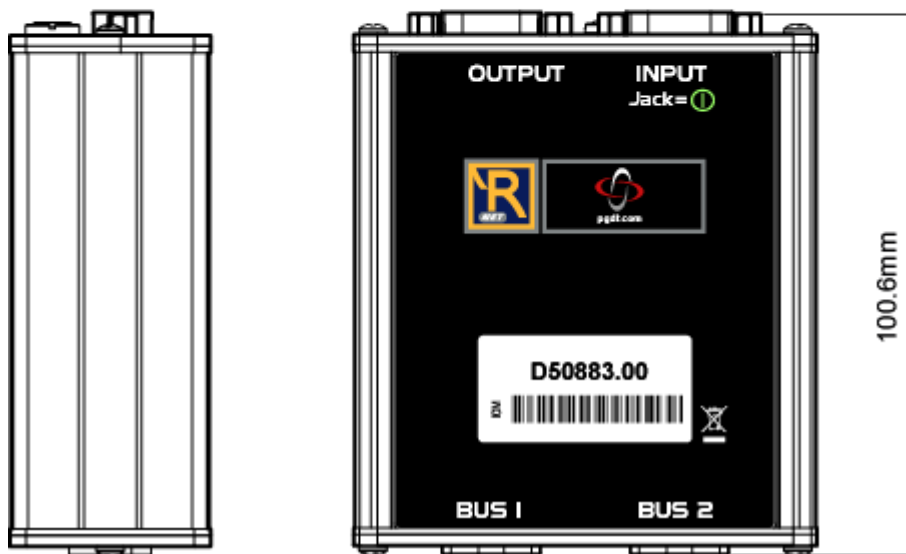
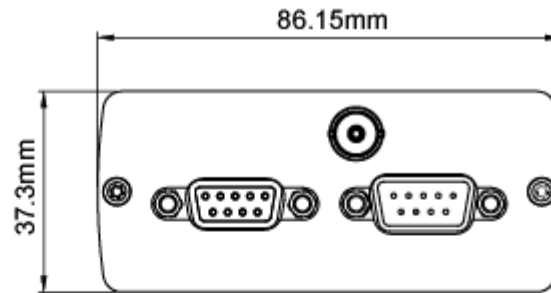

3 Mounting

3.1 Orientation

The IOM should be mounted so that water cannot enter and remain in the connector recesses. The recommended mounting orientation is such that the Module is lying flat. The function of the IOM is not sensitive to mounting orientation. The electronics compartment of the controller has an IPX4 dust and water rating.

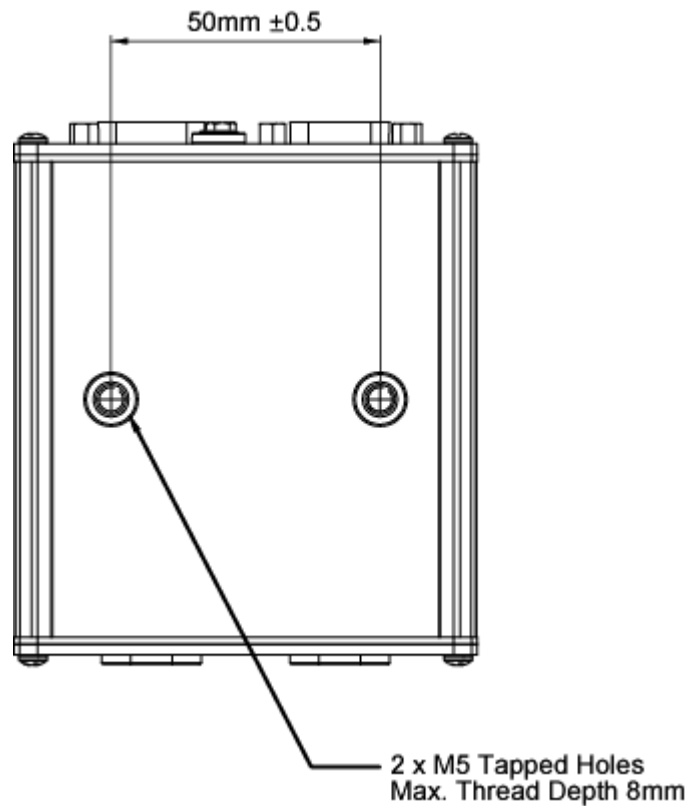

3.2 Position

The IOM must be mounted in a position where it is not exposed to levels of water, dust, shock or vibration above those expected on a mobility application. The IOM has been tested in accordance with ISO7176/14 with respect to these conditions. Contact PGDT if you need further advice.

3.3 Cables

The cables to the IOM must be routed and secured in such a way as to prevent damage to them, for example by cutting or crushing.

4 Connections

The IOM has the following connections:

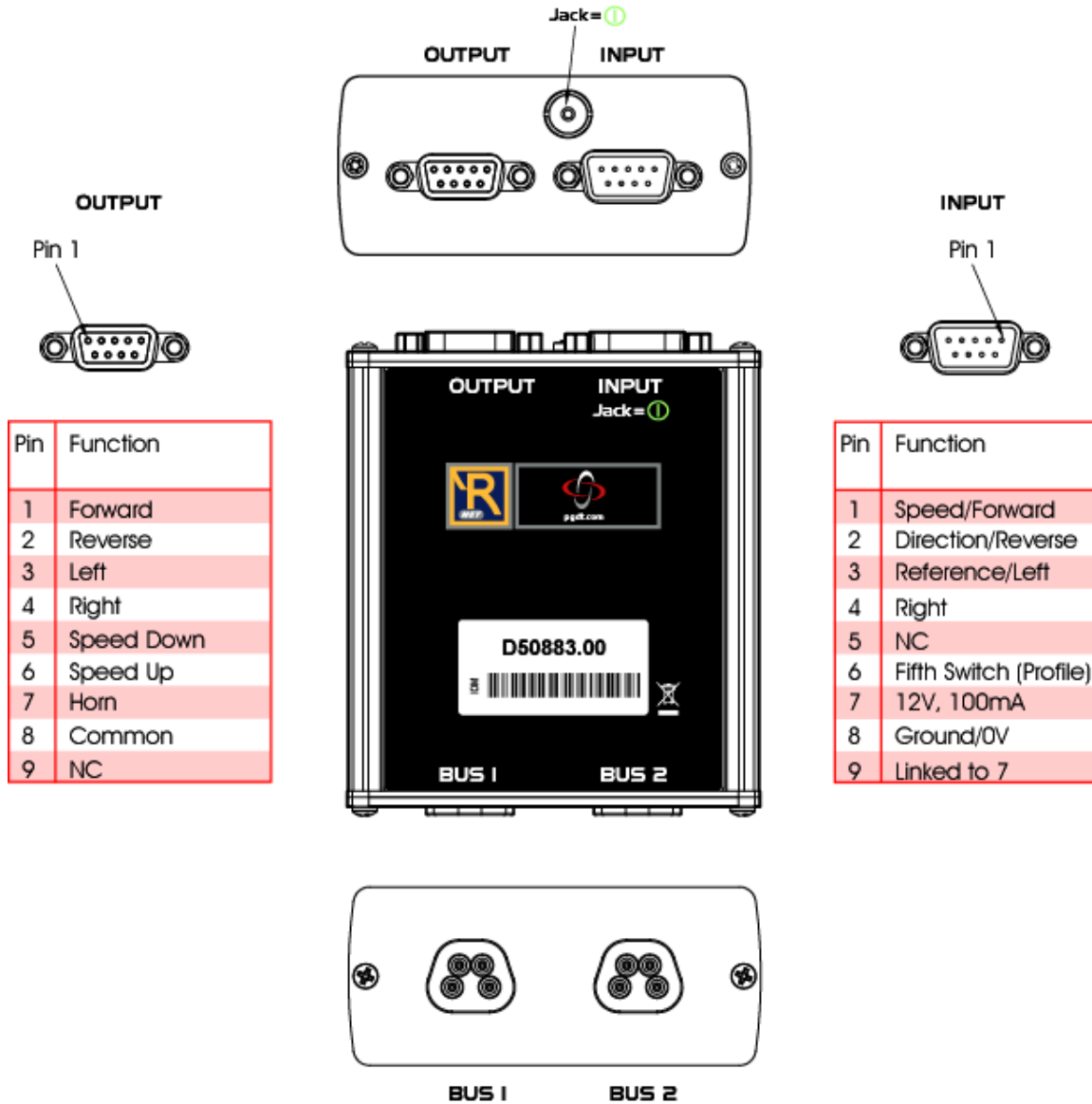

The Bus connections can only be used to connect the IOM to an R-net Control System using PG Drives Technology supplied R-net Communication Cables. PG Drives Technology accept no liability for any losses of any kind if an incorrect cable is not used.

4.1 On/Off Jack

This is a momentary type input and can be used to power-up and power-down the R-net system.

4.2 Communications Connectors

The 2 communication connectors are used to connect the IOM to other modules of the R-net System.

5 Configuration

The IOM can be configured to be either an Input Module or an Output Module. The IOM is wired to the Industry standard TRACE protocol. Multiple IOM's can be connected to the R-net system.

Configuration of the IOM is achieved via an internal identifier switch, which sets the IOM to either Input or Output.



Installation of an IOM module will not affect any current programmed conditions. However the programmed conditions can have an affect on the functionality of the Input and Output devices connected to the IOM.

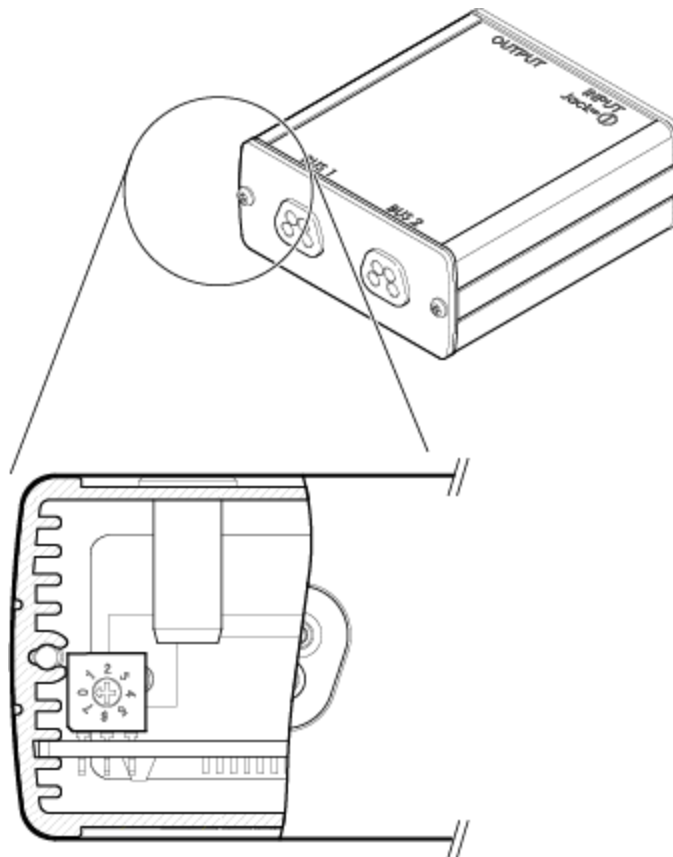

To adjust the switch position follow the procedure below.

- Disconnect all cables.
- Remove the retaining screws from the Bus connector plate.

- Gently pull the connector plate away from the housing, ensuring that the wiring remains intact.
- Adjust the internal identifier switch position to suit the wheelchairs requirements.
- Replace the connector plate and affix to the housing using the retaining screws.

5.1 Switch Position Definitions

Switch Position	Data Form	Programmer Reference
0	Input	IOM 1
1	Input	IOM 2
2	Input	IOM 3
3	Output	Output 3
4	Output	Output 4
5	Output	Output 5
6	Output	Output 6
7	Output	Output 7

5.2 Input Functions

The IOM can accommodate Switch and Analogue Input Devices. This will be determined by a programmable, profiled parameter, Input Type. Refer to Chapter 2 - Programming for details.

Input Example:

To fit a Head Switch Array, without a Rebus connector, into a Control System:

- Set the internal identifier switch to position 0.
- Connect the IOM to the R-net Control System.
- Connect the Head Switch Array to the IOM 9 Pin D-type Input connector.
- Turn the Control System on using the Head Switch Array On/Off control, or an On/Off button connected to the IOM's On/Off jack socket.

The Power Module is factory programmed to give control to the Input Device that has been used power it up. It is therefore possible to connect multiple Input Devices via IOM's.

It is possible to assign specific Input Devices to specific Profiles. Refer to the R-net Technical Manual, SK77981 for details.

5.2.1 Switch Function

When used with a Switch Input Device, such as a switch panel, the actual state of each of the 4 direction switches will be encoded onto the R-net communication protocol. Simultaneous depressions are accepted to affect diagonal changes in direction.

5.2.2 Proportional Function

When using a Proportional Input Device, such as a Mini Joystick, the joystick data will be encoded onto R-net communications protocol. The nature of the joystick data will be dependent on the system parameter Configuration – Input. Refer to Chapter 2 - Programming for details.

5.3 Output Functions

The IOM can control the four direction outputs in two ways.

- Only one output can be switched at a time.
- Two particular outputs can be switched together, i.e. to give a diagonal movement.

The outputs, Speed Up, Speed Down, and Horn reflect the actual state of these buttons on the Input Device in focus. These functions enable the use of devices such as PC mouse emulators where the speed up/down keys on the JSM can be configured to be right/left mouse clicks.

Output Example:

To fit an Environmental Control Module, without a Rebus connector, into a Control System:

- Set the internal identifier switch to position 5.
- Connect the IOM to the R-net Control System.
- Connect the Environmental Control Module to the IOM 9 Pin D-type Output connector.
- Turn the Control System and use the Mode Button to move to Mode 5.

The Power Module is factory programmed to accept IOM Output Devices in Modes 5, 6 & 7, when the IOM Internal Identifier Switch is set to position 5, 6 & 7 respectively. It is therefore possible to connect 3 IOM's as Output Devices, without having to adjust the programming parameters of the R-net.

It is possible to fit more Output Devices and to adjust which Modes activate them. Refer to the R-net Technical Manual, SK77981 for details.

5.3.1 Four-way Control

Only one output can be switched at one time. The output direction to joystick x-y data relationship is shown in Figure 1 below.

There is one associated programmable, profiled parameter, Output Switching. See programming section for further details.

5.3.2 Diagonal Control

Two outputs can be switched simultaneously. The output direction to joystick x-y data relationship is shown in Figure 2 below.

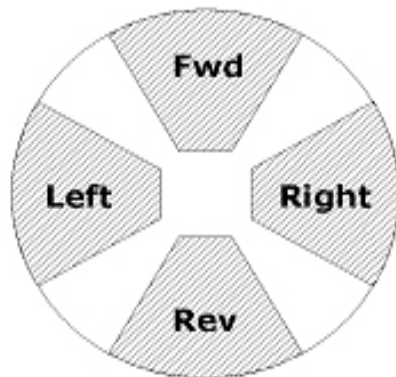

Figure 1

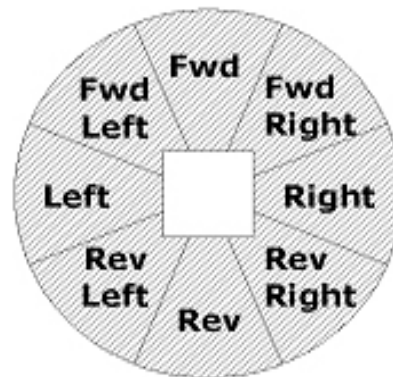

Figure 2

6 Global Inhibits

The IOM outputs are not affected by global (charger) inhibits.

7 Specifications



The information in this section can be used to design Specialty Input Devices compatible with the IOM. The input device manufacturer must ensure that the SID design is safe under all conditions, in particular, single component failures must be detected and the input device put into a safe condition. PG Drives Technology accept no responsibility for losses of any kind resulting from an unsuitable SID design.

7.1 9-way D Type (INPUT) Pin-out

9 WAY D-TYPE (INPUT)

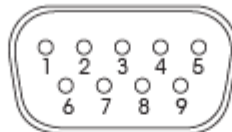

VIEWED FROM BELOW

Pin	Analog Function	Digital Function
1	Joystick Speed	Forward
2	Joystick Direction	Reverse
3	Joystick Reference	Left
4	-	Right
5	NC	NC
6	-	Fifth Switch
7	12V, 100mA	12V, 100mA
8	Joystick Ground	0V
9	Connected to 7	Connected to 7

The pins of the 9-way D type Input connector will have a different function depending on whether the IOM is configured for an analogue or a digital type input device.



The mating 9-way D type connector (socket) should always be fitted with gold contacts and a suitable backshell with locking screws. These locking screws should be used to mechanically hold the connector firmly in place.

7.2 Analog Signal Levels

The analogue inputs are compatible with PGDT JC200BR3K1Y and Flightlink I5X1SSG251020 joysticks.

7.2.1 Pin 1 - Joystick speed

This is the joystick signal that determines the forward/reverse component of wheelchair movement. The joystick has a 1.8K Ω resistor in series with the speed output as shown below. All voltage levels apply to the actual joystick output, i.e. no load values. The IOM has an input resistance of 100K Ω to 0V.

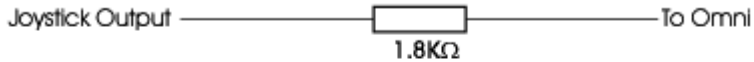

Neutral:	$V_{pin3} \pm$	30mV
Full Forward:	$V_{pin3} \pm$	1.2 nom.
Full Reverse:	$V_{pin3} \pm$	1.2 nom.

For optimum performance, The IOM should be calibrated for individual joysticks. The voltage swing of 1.2V is a nominal value, actual values of between 1.1V and 1.3V will be accepted by a calibration sequence.

If the voltage swing with respect to V_{pin3} exceeds 3.0V, then the IOM will assume a fault condition.

7.2.2 Pin 2 - Joystick direction

This is the joystick signal that determines the turning component of wheelchair movement. The joystick has a 1.8K Ω resistor in series with the direction output as shown below. All voltage levels apply to the actual joystick output, i.e. no load values. The IOM has an input resistance of 100K Ω to 0V.

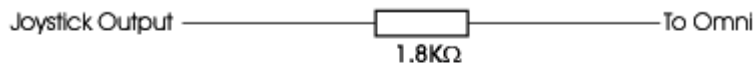

Neutral:	$V_{pin3} \pm$	30mV
Full Forward:	$V_{pin3} \pm$	1.2 nom.
Full Reverse:	$V_{pin3} \pm$	1.2 nom.

For optimum performance, The IOM should be calibrated for individual joysticks. The voltage swing of 1.2V is a nominal value, actual values of between 1.1V and 1.3V will be accepted by a calibration sequence.

If the voltage swing with respect to V_{pin3} exceeds 3.0V, then the IOM will assume a fault condition.

7.2.3 Pin 3 - Joystick reference

This is the joystick center point reference. The joystick has a 470 Ω resistor in series with the reference output as shown below. All voltage levels apply to the actual joystick output, i.e. no load values. The IOM has an input resistance of 200K Ω to 0V.



$$\text{Reference} = (V_{pin7} / 2) \pm (0.01 \times V_{pin7})$$

7.2.4 Pin 5 – Detect

This pin should be linked to 0V inside the input device. This link allows the IOM to detect if the SID is connected. If the link is not fitted, the IOM should be configured to ignore the absence of the link.

7.2.5 Pins 7 and 9 – 12V 100mA

These pins are connected together inside the IOM and provide a 12V supply to the joystick. The total combined current capability is 100mA.

7.2.6 Pin 8 – Joystick ground

A 0V supply for the joystick.

7.3 Digital Signal Levels

7.3.1 Pins 1,2,3 and 4 - Direction

Low signal < 0.7V

High signal > 1.4V

Impedance: 132K Ω to 3V

7.3.2 Pin 6 – Fifth Switch

Low signal < 0.7V

High signal > 1.4V

Impedance: 100K Ω to 5V

7.3.3 Pins 7 and 9 – 12V 100mA

These pins are connected together inside the IOM and provide a 12V supply to the input device. The total combined current capability is 100mA.

7.3.4 Pin 8 – 0V

A 0V supply for the input device.

7.4 On/Off Jack Socket

This section refers to the 3.5mm/1/8" jack socket on the IOM See the connections diagram in chapter 1 for more details.

7.4.1 Signal levels

Low signal < 0.8V

High signal > 4.0V

Impedance: 10K Ω to 5V

7.5 9-way D Type (OUTPUT) Pin-out

9 WAY D-TYPE (OUTPUT)

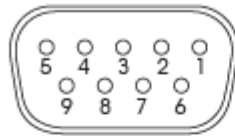

VIEWED FROM BELOW

Pin	Function
1	Forward
2	Reverse
3	Left
4	Right
5	Speed Down
6	Speed Up
7	Horn
8	COMMON
9	NC

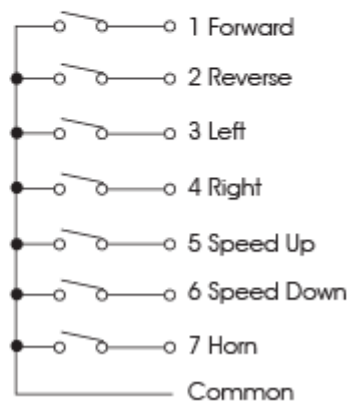

The 9-way D type Output connectors output rating is 0.5 A at 24Vdc, per pin.

The relay outputs are normally open. Operate by closing to Common.



CHAPTER 2 – PROGRAMMING

I Introduction

This chapter gives an overview of the specific IOM programmable parameters within the R-Net control system. The IOM parameters can only be programmed using a PG Drives Technology R-Net PC Programmer.

 **Programming should only be conducted by healthcare professionals with in-depth knowledge of PGDT Control Systems. Incorrect programming could result in an unsafe set-up of a wheelchair for a user. PGDT accept no responsibility for losses of any kind if the programming of the control system is altered from the factory pre-set values.**

To connect the R-net PC Programmer to the Control System use the USB connection cable and R-net Dongle as shown below. The Dongle can be connected to any point of the Control System.

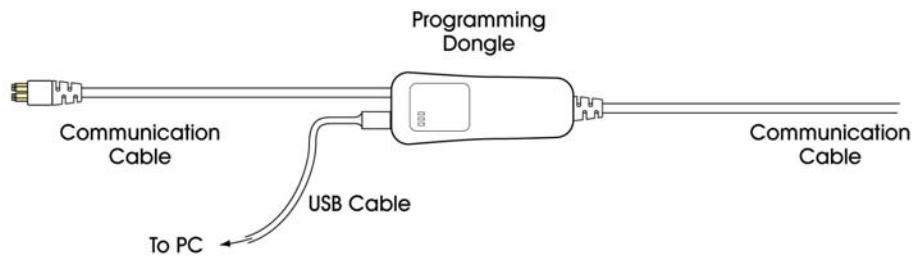

 **The control unit must be connected and ON before program transfer can be achieved.**

Check the Status Bar to see if the connection is correct. Refer to section 3.4.

 **Ensure the PC Programmer cable has been disconnected from the Control System before you start driving.**

2 Configuration

In the Configuration Menu you can define:

- The Mode Name
- The Output Data that is sent from the Input Device to the Output Device.
- The Output Device that is active in each Mode.

Parameter	Profile 1	Profile 2	Profile 3	Profile 4	Profile 5	Profile 6	Profile 7	Profile 8
Profile Management	Mode 1	Mode 2	Mode 3	Mode 4	Mode 5	Mode 6	Mode 7	Mode 8
Configuration	Mode 1	Mode 2	Mode 3	Mode 4	Mode 5	Mode 6	Mode 7	Mode 8
Mode Name	Drive	Seating	Bluetooth	Environmental	Mode 5	Mode 6	Mode 7	Programming
Input	Drive	Seating	Raw	Raw	Raw	Raw	Raw	Programming
Output	Drive	Seating	Mouse	Environmental	Output 5	Output 6	Output 7	Programming
Speeds	Profile 1	Profile 2	Profile 3	Profile 4	Profile 5	Profile 6	Profile 7	Attendant

 **When installing Input and Output Devices through an IOM it is only necessary to adjust these parameters if Multiple IOM's are fitted, or if the wheelchair has specific requirements. In these instances refer to the R-net Technical Manual SK7798I for Programming Details.**

3 IOM Specific Programming

3.1 Input Module – Input Type

The IOM can be programmed as an Input device to work with Switch or Proportional type devices. An example of such devices is a Head Switch Array control or a proportional joystick such PGDT JC200BR3K1Y.

Lights																				
Input Output Module																				
Input Module	Input 1	Input 2	Input 3																	
Input Type	Switch	Switch	Switch																	
Output Module	Output 3	Proportional	Output 5	Output 6	Output 7															
Output Switching	Four-Way	Four-Way	Four-Way	Four-Way	Four-Way															
Horn Operation	Output	Output	Output	Output	Output															
OEM Factory																				

3.2 Output Module

3.2.1 Output Switching

As an Output Device the IOM can be programmed to work in either Four-Way or Diagonal Output Types.

Four-way allows only one output to be switched at a time. Ie. Forward, Left, Right or Reverse.

Diagonal allows 2 Outputs to be switched simultaneously to give a diagonal movement. Ie. Forward and Left, giving a diagonal movement.

Lights																				
Input Output Module																				
Input Module	Input 1	Input 2	Input 3																	
Input Type	Switch	Switch	Switch																	
Output Module	Output 3	Output 4	Output 5	Output 6	Output 7															
Output Switching	Four-Way	Four-Way	Four-Way	Four-Way	Four-Way															
Horn Operation	Output	Output	Four-Way Diagonal Output	Output	Output															
OEM Factory																				

3.2.2 Horn Operation

The IOM can be configured to give an audible Horn output when the Horn button is pressed or to drive the Horn output relay. This allows the horn button on the JSM to activate an assigned function, for example navigating a screen in an Environmental control unit when in environmental mode.

Lights																				
Input Output Module																				
Input Module	Input 1	Input 2	Input 3																	
Input Type	Switch	Switch	Switch																	
Output Module	Output 3	Output 4	Output 5	Output 6	Output 7															
Output Switching	Four-Way	Four-Way	Four-Way	Four-Way	Four-Way															
Horn Operation	Output	Output	Four-Way Diagonal Output	Output	Output															
OEM Factory																				