



HYDROMETER

CORONA DP 405

MULTI-JET METER | DRY RUNNER



APPLICATION

Contact water meter for proportional control of pumps, motors, etc.
Metering with digital preselection of quantity and remote transmission of flow rates.

FEATURES

- ▶ Multi-jet impeller meter in completely dry-running design with magnetic coupling
- ▶ Only the impeller operates in the wet chamber to prevent faults due to sediment
- ▶ Encapsulated waterproof counter. Reading not obstructed by condensation of the transparent cover
- ▶ Counter can be rotated to any position for easy reading
- ▶ Built-in pulse contact (with cable 2 m) cast in a waterproof enclosure and easily replaceable
- ▶ Max. contact load 24 V (SELV) 0.2 A
- ▶ The outlet is prepared for installing a non-return valve (DVGW approved)

DIEHL
Metering

 smart in solutions

CORONA DP 405 Meter for horizontal pipes

MULTI-JET METER | DRY RUNNER

GENERAL

		Meter for horizontal pipes	
Medium temperature range	°C	0 ... 30	
Temperature safety	°C	0 ... 90	
Ambient storage temperature	°C	0 ... 55	
Nominal pressure	PN	bar	16
Display range	0.05 l ... 99,999 m ³		
Pulse value*	l/pulse	0.25, 0.5, 1, 2.5, 10, 100, 1000	
Approval	KTW, W270		
Accuracy class	A		
Protection class	IP 65		

* Reed switch with luster terminal available.

TECHNICAL DATA

Nominal diameter	DN	mm	20	25	40	50
Nominal flow rate	Q _n	m ³ /h	2.5	6	10	15
Overall length (DIN ISO 4064)	L	mm	190	260	300	270
Maximum flow rate (short-term)	Q _{max}	m ³ /h	5	12	20	30
Transition flow rate	Q _t	l/h	250	600	1000	1500
Minimum flow rate	Q _{min}	l/h	100	240	400	600
Starting flow rate		l/h	20-25	40-50	60-70	80-90
Flow rate at 1 bar pressure loss		m ³ /h	7	12	24	34

CORONA DP 405 Meter for horizontal pipes

MULTI-JET METER | DRY RUNNER

DIMENSIONS

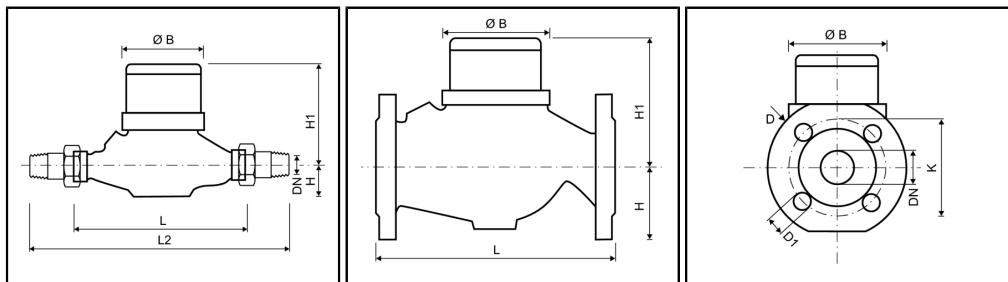

Nominal diameter	DN	mm	20	25	40	50
Nominal flow rate	Q_n	m ³ /h	2.5	6	10	15
Overall length (DIN ISO 4064)	L	mm	190	260	300	270
Overall length with coupling	L2	mm	288	378	438	-
Connection thread on meter (ISO 228/1)		Inch	G1B	G1¼B	G2B	-
Connection thread of coupling (DIN 2999)		Inch	R¾	R1	R1½	-
Flange diameter (DIN 2501)	D	mm	-	-	-	165
Hole circle diameter (DIN 2501)	K	mm	-	-	-	125
Number of screwholes		pcs	-	-	-	4
Screw hole diameter	D1	mm	-	-	-	18
Height	H	mm	35	45	50	83
Height	H1	mm	120	125	140	165
Diameter	Ø B	mm	96	102	137	166
Weight without coupling		kg	1.7	2.5	4.7	11.7
Weight with coupling		kg	2.1	3.1	5.9	-

PRESSURE LOSS GRAPH / TYPICAL ERROR GRAPH

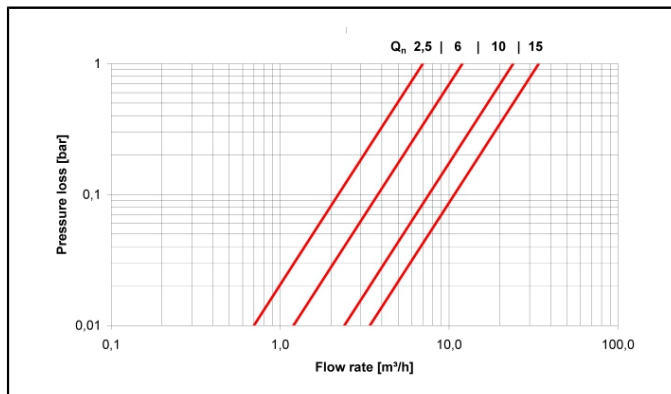

Pressure loss graph

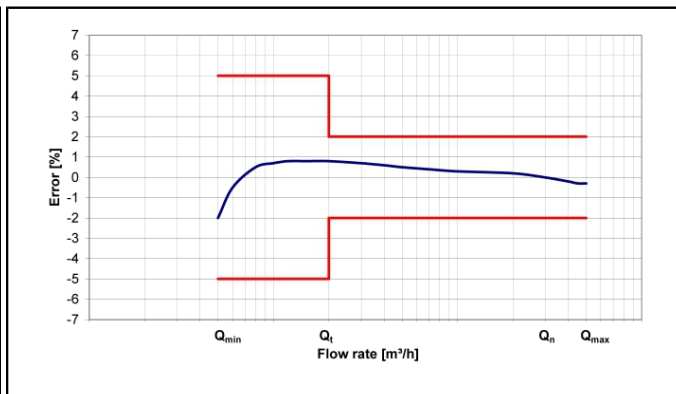

Typical error graph

CORONA DP 405 Meter for rising pipes

MULTI-JET METER | DRY RUNNER

GENERAL

Meter for rising pipes		
Medium temperature range	°C	0 ... 30
Temperature safety	°C	0 ... 90
Ambient storage temperature	°C	0 ... 55
Nominal pressure	PN bar	16
Display range		0.05 l ... 99,999 m ³
Pulse value*	l/pulse	0.25, 0.5, 1, 2.5, 10, 100, 1000
Approval		KTW, W270
Accuracy class		A
Protection class		IP 65

* Reed switch with luster terminal available.

TECHNICAL DATA

Nominal diameter	DN	mm	20	25	40
Nominal flow rate	Q _n	m ³ /h	2.5	6	10
Overall length (DIN ISO 4064)	L	mm	105	150	200
Maximum flow rate (short-term)	Q _{max}	m ³ /h	5	12	20
Transition flow rate	Q _t	l/h	250	600	1000
Minimum flow rate	Q _{min}	l/h	100	240	400
Starting flow rate		l/h	20-25	40-50	60-70
Flow rate at 1 bar pressure loss		m ³ /h	6	12	22

CORONA DP 405 Meter for rising pipes

MULTI-JET METER | DRY RUNNER

DIMENSIONS

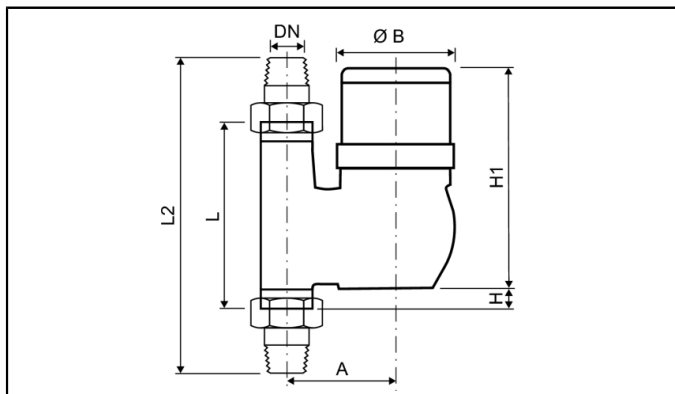

Nominal diameter	DN	mm	20	25	40
Nominal flow rate	Q_n	m ³ /h	2.5	6	10
Overall length (DIN ISO 4064)	L	mm	105	150	200
Overall length with coupling	L2	mm	203	268	338
Connection thread on meter (ISO 228/1)		Inch	G1B	G1¼B	G2B
Connection thread of coupling (DIN 2999)		Inch	R¾	R1	R1½
Height	H	mm	15	32	22
Height	H1	mm	154	165	177
Diameter	Ø B	mm	96	102	136
Width	A	mm	82	95	120
Weight without coupling		kg	2.1	3.1	5.5
Weight with coupling		kg	2.5	3.7	6.7

PRESSURE LOSS GRAPH / TYPICAL ERROR GRAPH

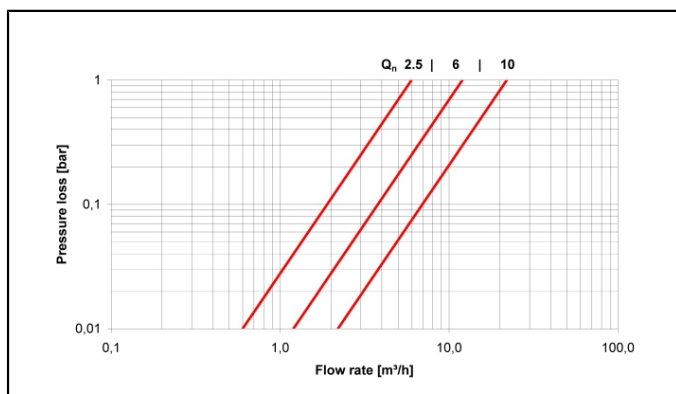

Pressure loss graph

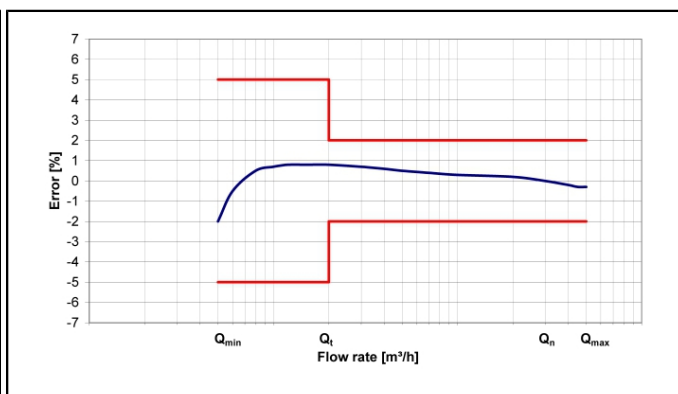

Typical error graph

HYDROMETER