



Datenblatt für die Print-Flachtransformatoren-Baureihe

Allgemeines (gilt für alle Typen):

- ✓ Zweikammerwicklung
- ✓ Isolationsklasse ta 40%E
- ✓ Vakuum vergossen
- ✓ RoHS-konform

Von den Standardspannungen und – strömen abweichende Werte auf Anfrage.
„Für gedruckte Schaltungen, vorbereitet für Schutzklasse II, mit UL-Zeichen (EN 61558 / UL 506) , CE-konform, Primär 2x115V / 1x230V, die angegebenen Sekundärströme gelten pro Wicklung.



Die Abbildungen zeigen das Schaltschema bei Serien – u. Parallelschaltung

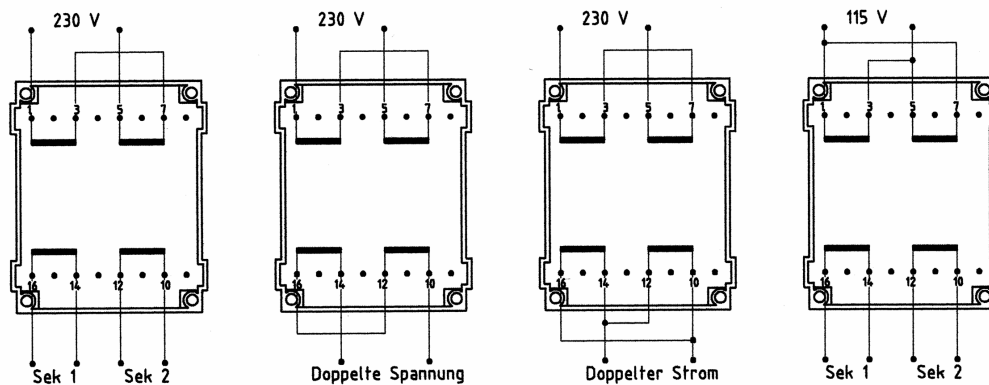

„Die Stiftbelegungen von Flachtransformatoren sind nicht genormt.
Die nachstehend gezeigten Anschlussbelegungen der WEISS-Flachtransformatoren entsprechen dem einschlägigen Standard.“

Typ: UI 30 4,0 VA

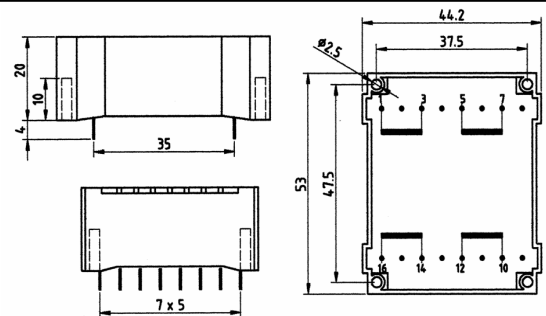

(L x B x H) 53 x 44 x 20 mm							
primär	Stifte	sekundär	Stifte:	Leerlaufspannung:	Gewicht	Kupfer-einsatzgewicht	Weiss-BV-Nr.
230 V AC (2 x 115 V)	1-3 / 7-5	2 x 6 V / 333 mA	10-12 / 16-14	9,5	142 g	53 g	83/222
230 V AC (2 x 115 V)	1-3 / 7-5	2 x 9 V / 222 mA	10-12 / 16-14	14,2	142 g	55 g	83/224
230 V AC (2 x 115 V)	1-3 / 7-5	2 x 12 V / 167 mA	10-12 / 16-14	19,0	142 g	53 g	83/225
230 V AC (2 x 115 V)	1-3 / 7-5	2 x 15 V / 133 mA	10-12 / 16-14	23,7	142 g	54 g	83/226
230 V AC (2 x 115 V)	1-3 / 7-5	2 x 18 V / 111 mA	10-12 / 16-14	28,5	142 g	56 g	83/227
230 V AC (2 x 115 V)	1-3 / 7-5	2 x 21 V / 95 mA	10-12 / 16-14	33,3	142 g	53 g	83/228



Datenblatt für die Print-Flachtransformatoren-Baureihe

Typ: UI 30 6,0 VA

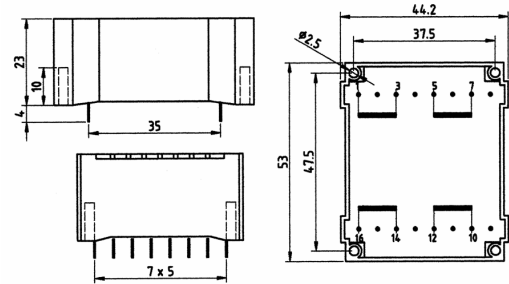

(L x B x H) 53 x 44 x 23 mm							
primär	Stifte	sekundär	Stifte:	Leerlaufspannung:	Gewicht	Kupfer-einsatzgewicht	Weiss-BV-Nr.
230 V AC (2 x 115 V)	1-3 / 7-5	2 x 6 V / 500 mA	10-12 / 16-14	9,5	170 g	55 g	83/232
230 V AC (2 x 115 V)	1-3 / 7-5	2 x 9 V / 333 mA	10-12 / 16-14	14,3	170 g	56 g	83/234
230 V AC (2 x 115 V)	1-3 / 7-5	2 x 12 V / 250 mA	10-12 / 16-14	19,1	170 g	55 g	83/235
230 V AC (2 x 115 V)	1-3 / 7-5	2 x 15 V / 200 mA	10-12 / 16-14	23,9	170 g	55 g	83/236
230 V AC (2 x 115 V)	1-3 / 7-5	2 x 18 V / 167 mA	10-12 / 16-14	28,7	170 g	57 g	83/237
230 V AC (2 x 115 V)	1-3 / 7-5	2 x 21 V / 143 mA	10-12 / 16-14	33,5	170 g	56 g	83/238

Typ: UI 30 10,0 VA

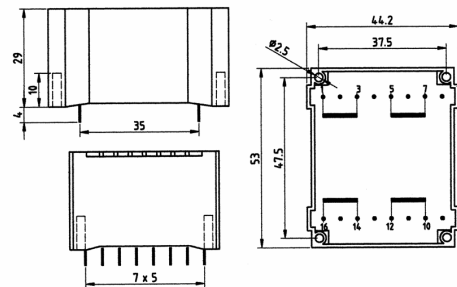

(L x B x H) 53 x 44 x 29 mm							
primär	Stifte	sekundär	Stifte:	Leerlaufspannung:	Gewicht	Kupfer-einsatzgewicht	Weiss-BV-Nr.
230 V AC (2 x 115 V)	1-3 / 7-5	2 x 6 V / 833 mA	10-12 / 16-14	8,6	260 g	70 g	83/242
230 V AC (2 x 115 V)	1-3 / 7-5	2 x 9 V / 556 mA	10-12 / 16-14	12,9	260 g	68 g	83/244
230 V AC (2 x 115 V)	1-3 / 7-5	2 x 12 V / 417 mA	10-12 / 16-14	17,3	260 g	70 g	83/245
230 V AC (2 x 115 V)	1-3 / 7-5	2 x 15 V / 333 mA	10-12 / 16-14	21,6	260 g	69 g	83/246
230 V AC (2 x 115 V)	1-3 / 7-5	2 x 18 V / 278 mA	10-12 / 16-14	25,9	260 g	68 g	83/247
230 V AC (2 x 115 V)	1-3 / 7-5	2 x 21 V / 238 mA	10-12 / 16-14	30,3	260 g	69 g	83/248



Datenblatt für die Print-Flachtransformatoren-Baureihe

Die Abbildungen zeigen das Schaltschema bei Serien- und Parallelschaltung

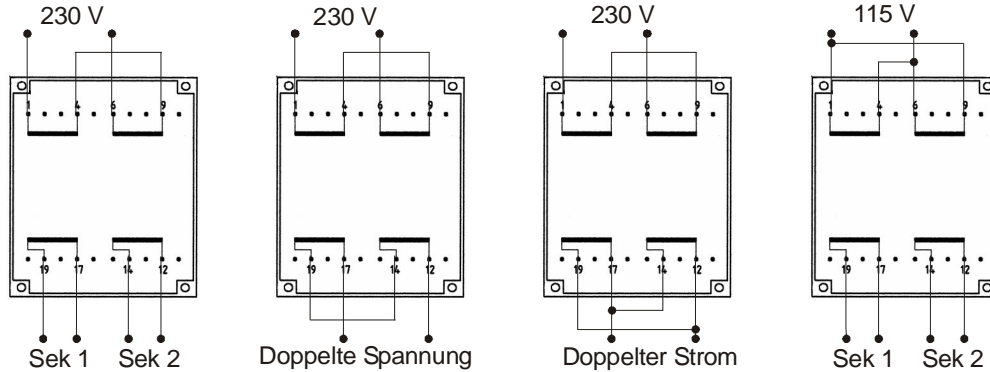

Typ: UI 39/10,2 14,0 VA

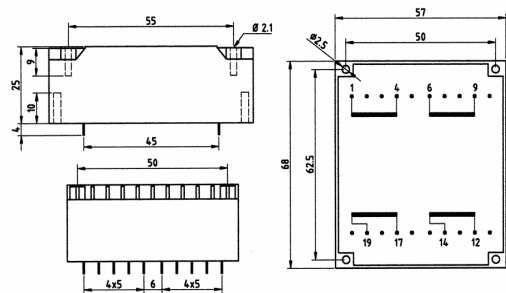
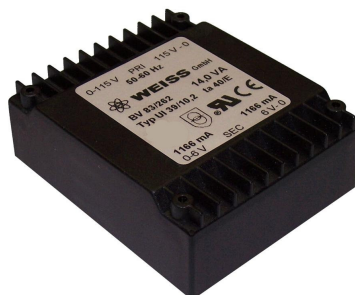

(L x B x H) 68 x 57 x 25 mm

primär	Stifte	sekundär	Stifte:	Leerlaufspannung:	Gewicht	Kupfer-einsatzgewicht	Weiss-BV-Nr.
230 V AC (2 x 115 V)	1-4 / 9-6	2 x 6 V / 1167 mA	12-14 / 19-17	9,0	310 g	124 g	83/262
230 V AC (2 x 115 V)	1-4 / 9-6	2 x 9 V / 778 mA	12-14 / 19-17	13,5	310 g	124 g	83/264
230 V AC (2 x 115 V)	1-4 / 9-6	2 x 12 V / 583 mA	12-14 / 19-17	18,0	310 g	124 g	83/265
230 V AC (2 x 115 V)	1-4 / 9-6	2 x 15 V / 467 mA	12-14 / 19-17	22,5	310 g	124 g	83/266
230 V AC (2 x 115 V)	1-4 / 9-6	2 x 18 V / 389 mA	12-14 / 19-17	27,0	310 g	124 g	83/267
230 V AC (2 x 115 V)	1-4 / 9-6	2 x 21 V / 333 mA	12-14 / 19-17	31,5	310 g	124 g	83/268

Typ: UI 39/13,5 18,0 VA

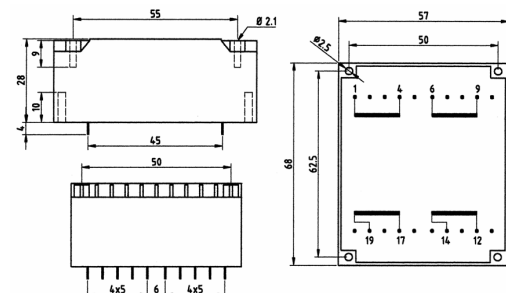
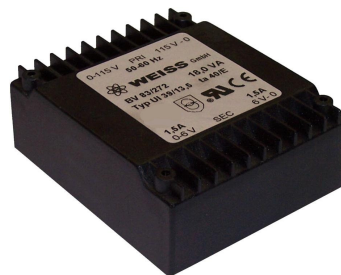

(L x B x H) 68 x 57 x 28 mm

primär	Stifte	sekundär	Stifte:	Leerlaufspannung:	Gewicht	Kupfer-einsatzgewicht	Weiss-BV-Nr.
230 V AC (2 x 115 V)	1-4 / 9-6	2 x 6 V / 1500 mA	12-14 / 19-17	8,3	370 g	135 g	83/272
230 V AC (2 x 115 V)	1-4 / 9-6	2 x 9 V / 1000 mA	12-14 / 19-17	12,5	370 g	135 g	83/274
230 V AC (2 x 115 V)	1-4 / 9-6	2 x 12 V / 750 mA	12-14 / 19-17	16,7	370 g	135 g	83/275
230 V AC (2 x 115 V)	1-4 / 9-6	2 x 15 V / 600 mA	12-14 / 19-17	20,9	370 g	135 g	83/276
230 V AC (2 x 115 V)	1-4 / 9-6	2 x 18 V / 500 mA	12-14 / 19-17	25,1	370 g	135 g	83/277
230 V AC (2 x 115 V)	1-4 / 9-6	2 x 21 V / 429 mA	12-14 / 19-17	29,3	370 g	135 g	83/278



Datenblatt für die Print-Flachtransformatoren-Baureihe

Typ: UI 39/17 24,0 VA

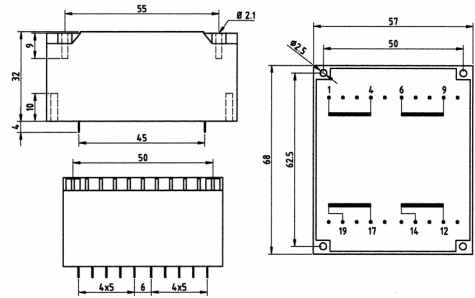

(L x B x H) 68 x 57 x 32 mm							
primär	Stifte	sekundär	Stifte:	Leerlaufspannung:	Gewicht	Kupfer-einsatzgewicht	Weiss-BV-Nr.
230 V AC (2 x 115 V)	1-4 / 9-6	2 x 6 V / 2000 mA	12-14 / 19-17	7,6	435 g	152 g	83/282
230 V AC (2 x 115 V)	1-4 / 9-6	2 x 9 V / 1333 mA	12-14 / 19-17	11,5	435 g	152 g	83/284
230 V AC (2 x 115 V)	1-4 / 9-6	2 x 12 V / 1000 mA	12-14 / 19-17	15,3	435 g	152 g	83/285
230 V AC (2 x 115 V)	1-4 / 9-6	2 x 15 V / 800 mA	12-14 / 19-17	19,2	435 g	152 g	83/286
230 V AC (2 x 115 V)	1-4 / 9-6	2 x 18 V / 667 mA	12-14 / 19-17	23,0	435 g	152 g	83/287
230 V AC (2 x 115 V)	1-4 / 9-6	2 x 21 V / 572 mA	12-14 / 19-17	26,9	435 g	152 g	83/288

Typ: UI 39/21 30,0 VA

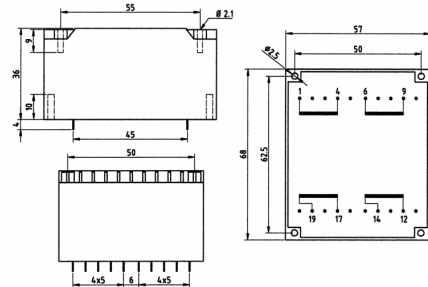

(L x B x H) 68 x 57 x 36 mm							
primär	Stifte	sekundär	Stifte:	Leerlaufspannung:	Gewicht	Kupfer-einsatzgewicht	Weiss-BV-Nr.
230 V AC (2 x 115 V)	1-4 / 9-6	2 x 6 V / 2500 mA	12-14 / 19-17	7,5	520 g	161 g	83/292
230 V AC (2 x 115 V)	1-4 / 9-6	2 x 9 V / 1667 mA	12-14 / 19-17	11,3	520 g	161 g	83/294
230 V AC (2 x 115 V)	1-4 / 9-6	2 x 12 V / 1250 mA	12-14 / 19-17	15,1	520 g	161 g	83/295
230 V AC (2 x 115 V)	1-4 / 9-6	2 x 15 V / 1000 mA	12-14 / 19-17	18,9	520 g	161 g	83/296
230 V AC (2 x 115 V)	1-4 / 9-6	2 x 18 V / 833 mA	12-14 / 19-17	22,7	520 g	161 g	83/297
230 V AC (2 x 115 V)	1-4 / 9-6	2 x 21 V / 715 mA	12-14 / 19-17	26,5	520 g	161 g	83/298



Datenblatt für die Print-Flachtransformatoren-Baureihe

Die Abbildungen zeigen das Schaltschema bei Serien- und Parallelschaltung

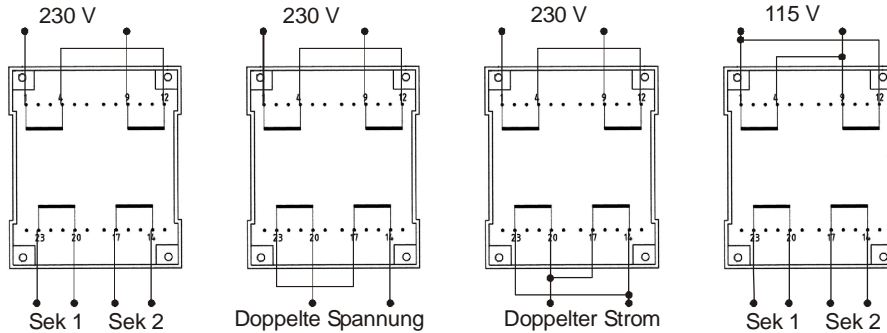

Typ: UI 48/17 45,0 VA

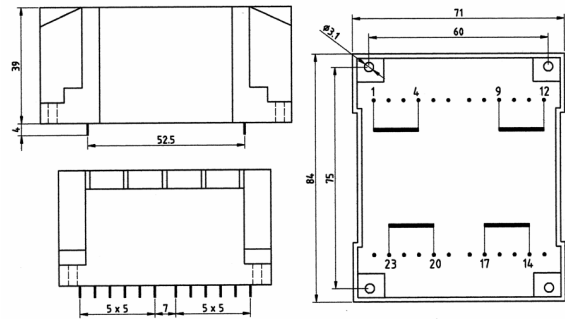

(L x B x H) 84 x 71 x 39 mm								
primär	Stifte	sekundär	Stifte:	Leerlaufspannung:	Gewicht	Kupfer-einsatzgewicht	Weiss-BV-Nr.	
230 V AC (2 x 115 V)	1-4 / 12-9	2 x 6 V / 3750 mA	14-17 / 23-20	7,5	820 g	277 g	83/412	
230 V AC (2 x 115 V)	1-4 / 12-9	2 x 9 V / 2500 mA	14-17 / 23-20	11,3	820 g	277 g	83/414	
230 V AC (2 x 115 V)	1-4 / 12-9	2 x 12 V / 1875 mA	14-17 / 23-20	15,1	820 g	277 g	83/415	
230 V AC (2 x 115 V)	1-4 / 12-9	2 x 15 V / 1500 mA	14-17 / 23-20	18,9	820 g	277 g	83/416	
230 V AC (2 x 115 V)	1-4 / 12-9	2 x 18 V / 1250 mA	14-17 / 23-20	22,7	820 g	277 g	83/417	
230 V AC (2 x 115 V)	1-4 / 12-9	2 x 21 V / 1070 mA	14-17 / 23-20	26,5	820 g	277 g	83/418	

Typ: UI 48/26 60,0 VA

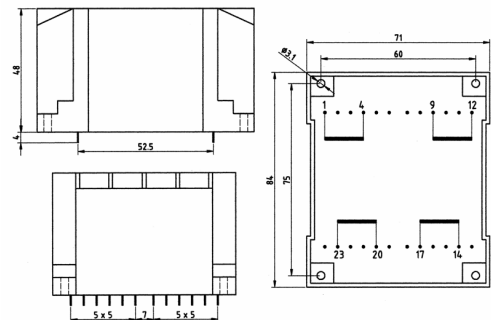

(L x B x H) 84 x 71 x 48 mm								
primär	Stifte	sekundär	Stifte:	Leerlaufspannung:	Gewicht	Kupfer-einsatzgewicht	Weiss-BV-Nr.	
230 V AC (2 x 115 V)	1-4 / 12-9	2 x 6 V / 5000 mA	14-17 / 23-20	6,8	1080 g	312 g	83/422	
230 V AC (2 x 115 V)	1-4 / 12-9	2 x 9 V / 3335 mA	14-17 / 23-20	10,2	1080 g	312 g	83/424	
230 V AC (2 x 115 V)	1-4 / 12-9	2 x 12 V / 2500 mA	14-17 / 23-20	13,6	1080 g	312 g	83/425	
230 V AC (2 x 115 V)	1-4 / 12-9	2 x 15 V / 2000 mA	14-17 / 23-20	17,1	1080 g	312 g	83/426	
230 V AC (2 x 115 V)	1-4 / 12-9	2 x 18 V / 1665 mA	14-17 / 23-20	20,5	1080 g	312 g	83/427	
230 V AC (2 x 115 V)	1-4 / 12-9	2 x 21 V / 1570 mA	14-17 / 23-20	23,9	1080 g	312 g	83/428	