

Technical Catalogue

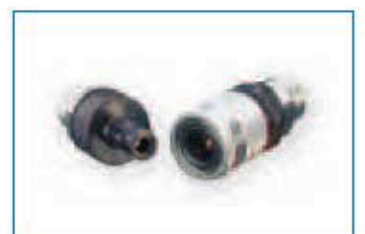

Nom. bore	Type	Max. static working pressure [bar/psi]			C _v value		Cross section [mm ²]	Page
		steel	brass	st. st.	both sides self sealing	one side self sealing		
2.5	06-003	–	100	–	–	0.165	5	11
3	LP-003	–	200	–	–	0.21	8	12
3	07-003	–	200	200	0.14	–	7.1	13
4	LP-004	60	20	20	0.3	0.36	13	14
4	LV-004	–	20	20	0.3	–	13	15
6	LP-006	60	40	40	0.73	1.13	30	16 – 17
6	SP-006	100	60	60	0.77	1.1	30	18 – 19
7	LP-007	50	40	40	1.17	1.5	40	20 – 21
9	SP-009	100	40	40	2.1	2.41	64	22 – 23
12	LP-012	50	30	30	3.28	4.34	120	24 – 25
19	LP-019	50	30	30	8.4	11.6	300	26 – 27
32	LP-032	30	30	30	23.8	29.4	800	28 – 29
50	LP-050	30	20	20	59	68	2000	30 – 31
Performance diagrams								32 – 33
Multiway connectors								34

Types LV-004, LP-006, SP-006, LP-007, SP-009 and LP-012 in stainless steel are supplied with gripping grooves instead of knurling as a standard feature

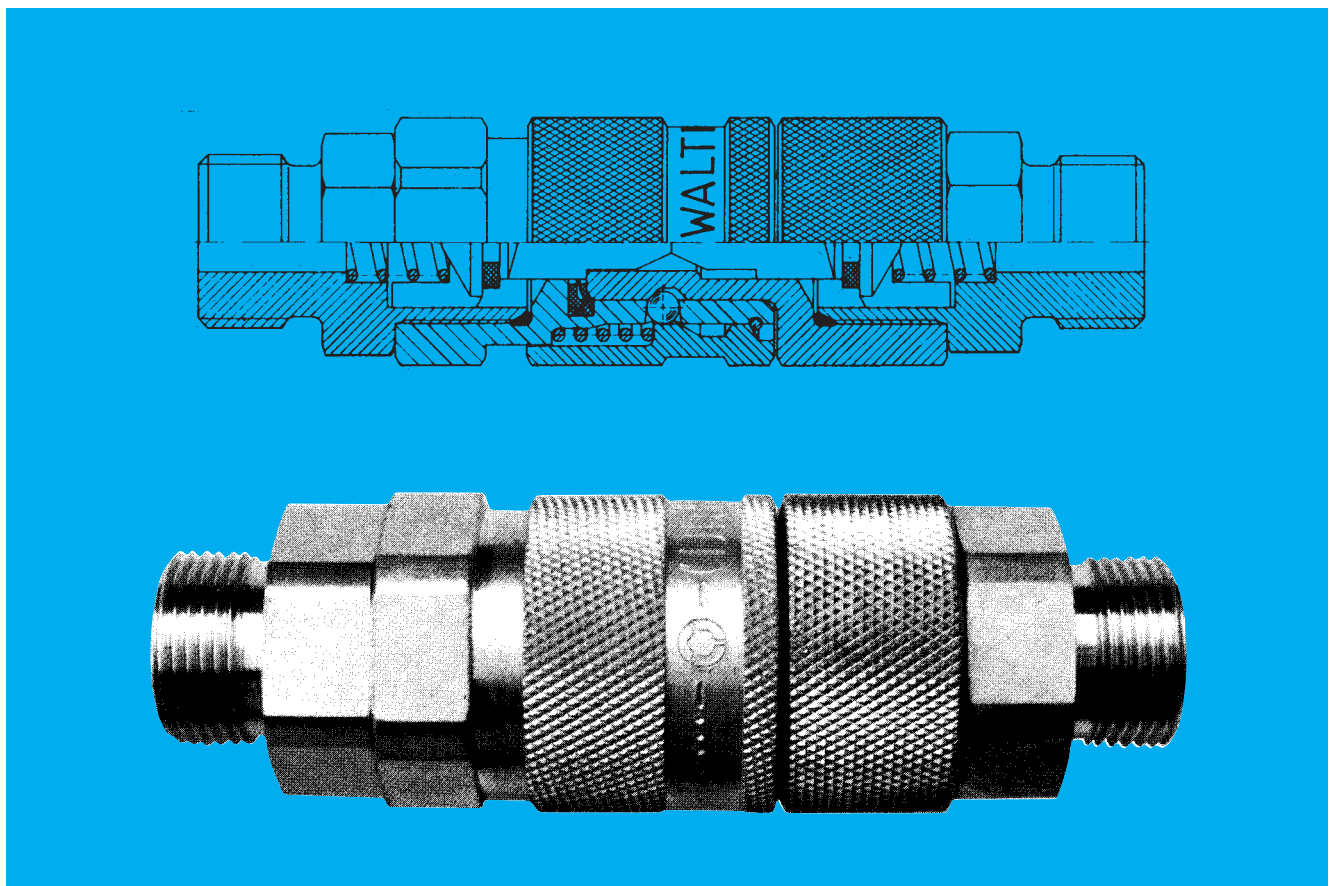

10 Low pressure Series LP

The series LP offers couplings with one side or both sides self sealing and valves in nominal bore 2.5 to 50 mm. This series is supplied in different materials and surface coatings.

With the exception of types LP-032 and LP-050 the LP series is also suitable for vacuum applications (in connected condition).

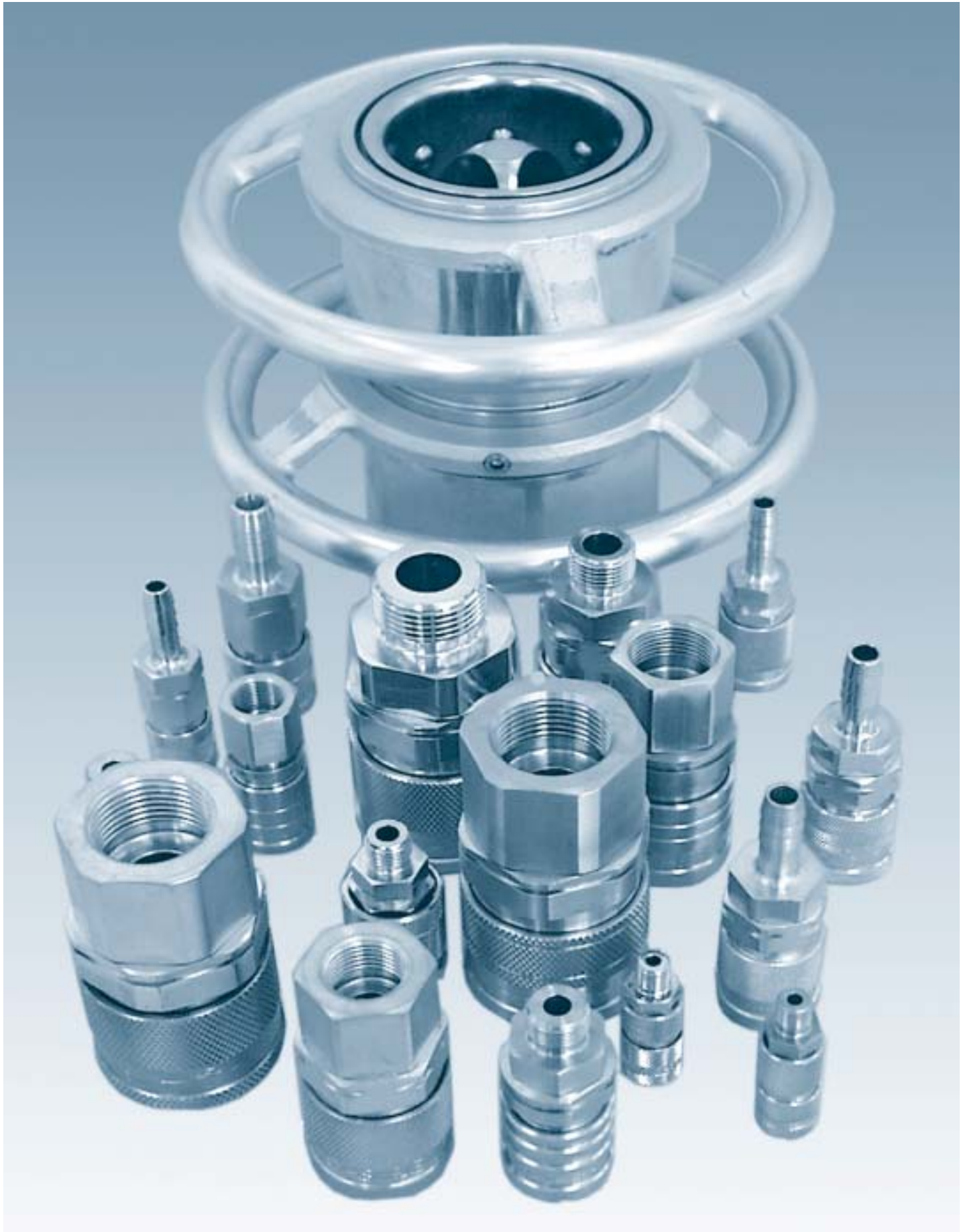

characteristic features:
 - automatic lock (one hand operation)
 - mini coupling

materials:
standard:
 23 = brass, nickel plated

seal qualities:
 1 = NBR
 2 = FKM
 4 = EPDM

optional features:
 OV = without valve
 (no one hand operation)

Please note the technical data on pages 2 - 7, 32 - 33 and the max. working pressures on page 9

Availability: ● Short ◐ Medium ○ Long

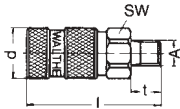
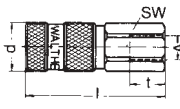
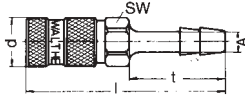
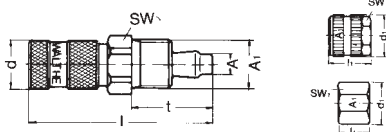
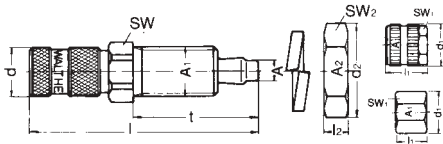
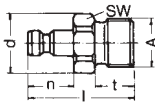
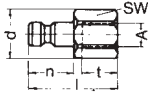
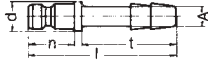
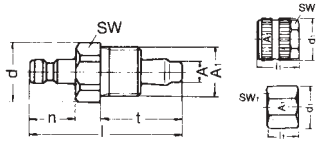
	Part No.	Connec- tion A	brass nickel plated	A ₁	SW	SW ₁	l	l ₁	d	d ₁	t	n	weight [g]
				A ₂		SW ₂		l ₂		d ₂			
Self sealing couplings	 male thread	06-003-0-XX001-23-	●		9		26,5		10		6		8
		06-003-0-XX010-23-	●		11		30,5		10		10		12
	 female thread	06-003-0-XX015-23-	●		9		28		10		7		11
	 hose connection	06-003-0-SL004-23-	●		9		39,5		10		19		10
	 re-usable hose connection with swivel nut for plastic pipes	06-003-0-SW003-23-	●	M 7 x 0,5	9	7	32,5	9	10	8	12		11
		06-003-0-SW004-23-	●	M 10 x 1	11	13	36,5	13,5	10	14,3	16		21
 re-usable hose connection with swivel nut for plastic pipes and with counternut for bulkhead mounting, max. thickness 4 mm	06-003-0-XX017-23-	○	M 7 x 0,5 M 7 x 0,5	9	7 11	45,5	9 3	10	8 12	25		24	
	06-003-0-XX006-23-	●	M 10 x 1 M 10 x 1	11	13 17	45,5	13,5 5	10	14,3 18,9	25		25	
Thru type adaptors	 male thread	06-003-1-XX001-23	●		9		19		9,9		6	9	4
		06-003-1-WR010-23	◐		11		21		12		8	9	6
	 female thread	06-003-1-XX015-23	◐		9		18		9,9		7	9	5
	 hose connection	06-003-1-SL004-23	●				29,5		6		19	9	3
	 re-usable hose connection with swivel nut for plastic pipes	06-003-1-SW003-23	●	M 7 x 0,5	8	7	25	9	8,9	8	12	9	5
06-003-1-SW004-23		◐	M 10 x 1	11	13	29	13,5	12	14,3	16	9	17	

characteristic features:
- automatic lock (one hand operation)

materials:
standard:
23 = brass, nickel plated

seal qualities:
1 = NBR
2 = FKM
4 = EPDM

optional features:
OV = without valve

Please note the technical data on pages 2 - 7, 32 - 33 and the max. working pressures on page 9

Availability: ● Short ○ Medium ○ Long

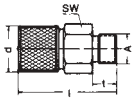
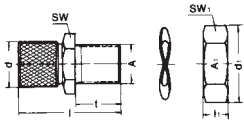
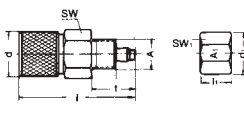
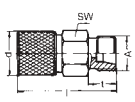
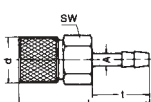
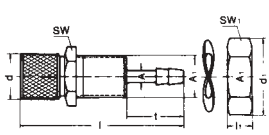
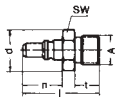
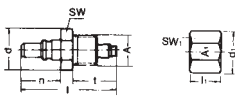
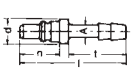
	Part No.	Connection A/A ₁	brass nickel-plated	pipe od	n.b.	SF/SF ₁	l	l ₁	d	d ₁	t	n	Weight [g]	
Self sealing couplings	 British standard pipe parallel (BSPP) male thread to DIN ISO 228	LP-003-0-WR010-23-.	BSPP 1/8"	●			14	32,5	15		8		32	
	 male thread to DIN ISO 228 for bulkhead mounting (max. thickness 2 mm), complete with counternut	LP-003-0-XX016-23-.	BSPP 1/4"	○			17	34	6	15	23,9	15		46
	 re-usable hose connection with swivel nut for plastic pipes	LP-003-0-SW004-23-.	OD 6 ID 4 mm M 10 x 1	○			14	40,5	13,5	15	14,3	16		50
	 metric male thread with 24° sealing cone to DIN 2353 (light duty series L)	LP-003-0-L0612-23-.	M 12 x 1,5	○	6	4	14	34,5		15		10		38
	 hose connection	LP-003-0-SL004-23-.	4 mm	●			14	44,5		15		19		36
	 male thread with 4 mm hose connection for bulkhead mounting (max. thickness 2 mm) complete with counternut	LP-003-0-XX004-23-.	4 mm M 14 x 1,5	●			17	54,5	6	15	25,4	19		50
Thru type adaptors	 British standard pipe parallel (BSPP) male thread to DIN ISO 228	LP-003-1-WR010-23	BSPP 1/8"	●			12	25	13,8		8	13	9	
	 re-usable hose connection with swivel nut for plastic pipes	LP-003-1-SW004-23	OD 6 ID 4 mm M 10 x 1	○			12	33	13,5	13,2	14,3	16	13	17
	 hose connection	LP-003-1-SL004-23	4 mm	●				35		8		19	13	4

characteristic features:
- automatic lock (one hand operation)

materials:
standard:
23 = brass, nickel plated

seal qualities:
1 = NBR
2 = FKM
4 = EPDM

special materials:
1 = stainless steel 1.4404/1.4571 or similar

Please note the technical data on pages 2 - 7, 32 - 33 and the max. working pressures on page 9

Availability: ● Short ◐ Medium ○ Long

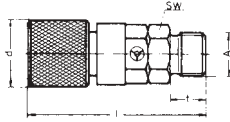
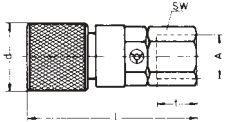
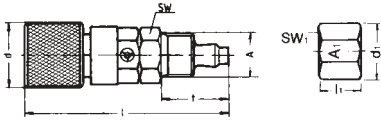
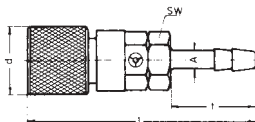
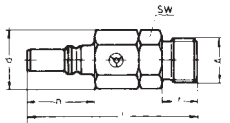
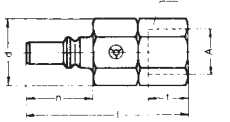
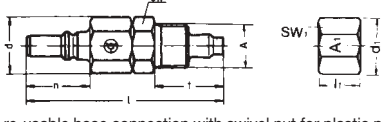
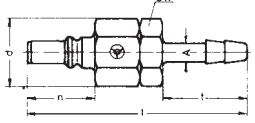
	Part No.	Connection A/ A ₁	brass nickel plated	AISI 316 ti//1.4571	pipe od	n.b.	d	d _i	SW SW _i	l	l _i	t	n	Weight [g]
Self sealing couplings	 British standard pipe parallel (BSPP) male thread to DIN ISO 228	07-003-0-WR010-...-	BSPP 1/8"	●	○		15		12 —	39,8		8		32
	 British standard pipe parallel (BSPP) female thread to DIN ISO 228	07-003-0-WR510-...-	BSPP 1/8"	○	○		15		12 —	37,8		9		30
	 re-usable hose connection with swivel nut for plastic pipes	07-003-0-SW004-...-	OD 6 ID 4 mm M 10 x 1	○	○		15	14,3	12 13	47,8	13,5	16		41
	 hose connection	07-003-0-SL004-...-	4 mm	○	○		15		12 —	51,8		19		32
Self sealing adaptors	 British standard pipe parallel (BSPP) male thread to DIN ISO 228	07-003-2-WR010-...-	BSPP 1/8"	●	○		13,2		12 —	38		8	15	18
	 British standard pipe parallel (BSPP) female thread to DIN ISO 228	07-003-2-WR510-...-	BSPP 1/8"	○	○		13,2		12 —	36		9	15	15
	 re-usable hose connection with swivel nut for plastic pipes	07-003-2-SW004-...-	OD 6 ID 4 mm M 10 x 1	○	○		13,2	14,3	12 13	46	13,5	16	15	27
	 hose connection	07-003-2-SL004-...-	4 mm	○	○		13,2		12 —	50		19	15	17

optional features:
OV = without valve

see also type LV-004 in extended version and with non squirt feature (in stainless steel or alternatively brass passivated)

materials:
standard:
11 = steel, zinc plated
21 = brass, passivated
23 = brass, nickel plated

special materials:
31 = aluminium anodized silver
13 = steel, chem. nickel plated
24 = brass, chem. nickel plated

seal qualities:
1 = NBR
2 = FKM
4 = EPDM

Please note the technical data on pages 2 - 7, 32 - 33 and the max. working pressures on page 9

Availability: ● Short ● Medium ○ Long

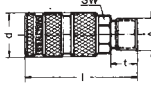
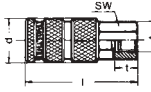
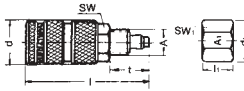
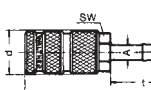
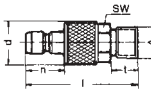
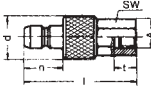
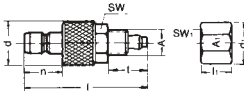
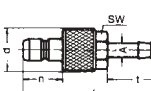
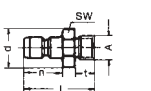
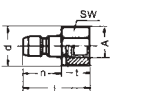
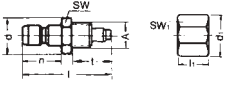
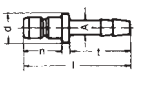
	Part No.	Connection A/ A ₁	steel zinc-plated	brass passivated	brass nickel-plated	pipe od	n.b.	d	d ₁	SF/SF ₁	l/l ₁	t	n	Weight [g]
Self sealing couplings	 <p>British standard pipe parallel (BSPP) male thread to DIN ISO 228</p>	LP-004-0-WR010-...	BSPP 1/8"	●	●	●		18		14/—	45,5/—	8		50
		LP-004-0-WR013-...	BSPP 1/4"	●	●	○		18		14/—	46,5/—	11		55
	 <p>British standard pipe parallel (BSPP) female thread to DIN ISO 228</p>	LP-004-0-WR510-...	BSPP 1/8"	●	●	●		18		14/—	45,5/—	9		55
		 <p>re-usable hose connection with swivel nut for plastic pipes</p>	LP-004-0-SW004-...	OD 6 ID 4 mm M 10 x 1		●	○		18	14,3	14/13	51,5/13,5	16	
 <p>hose connection</p>	LP-004-0-SL004-...		4 mm	●	●	●		18		12/—	50/—	19	15	47
	LP-004-0-SL006-...	6 mm	●	●	●		18		14/—	60,5/—	25		50	
Self sealing adaptors	 <p>British standard pipe parallel (BSPP) male thread to DIN ISO 228</p>	LP-004-2-WR010-...	BSPP 1/8"	●	●	●		18		14/—	45/—	8	16	36
		LP-004-2-WR013-...	BSPP 1/4"	●	●	○		18		14/—	46/—	11	16	41
	 <p>British standard pipe parallel (BSPP) female thread to DIN ISO 228</p>	P-004-2-WR510-...	BSPP 1/8"	●	●	●		18		14/—	45/—	9	16	41
		 <p>re-usable hose connection with swivel nut for plastic pipes</p>	LP-004-2-SW004-...	OD 6 ID 4 mm		●	○		18	14,3	14/13	51/13,5	16	16
 <p>hose connection</p>	LP-004-2-SL004-...		4 mm	●	●	●		18		14/—	53/—	18	16	33
	LP-004-2-SL006-...	6 mm	●	●	●		18		14/—	60/—	25	16	36	
Thru type adaptors	 <p>British standard pipe parallel (BSPP) male thread to DIN ISO 228</p> <p>metric ISO fine-pitch thread, male to DIN 13 with pitch 1,0 mm</p>	LP-004-1-WR010-...	BSPP 1/8"	●	●	●		16,2		14/—	29/—	8	16	15
		LP-004-1-WR013-...	BSPP 1/4"	●	●	○		16,2		14/—	32/—	11	16	20
		LP-004-1-4M010-...	M 10 x 1		●	○		14,8		13/—	28/—	8	16	17
	 <p>British standard pipe parallel (BSPP) female thread to DIN ISO 228</p>	LP-004-1-WR510-...	BSPP 1/8"	●	●	●		16,2		14/—	29/—	9	16	18
		 <p>re-usable hose connection with swivel nut for plastic pipes</p>	LP-004-1-SW004-...	OD 6 ID 4 mm		○	○		13,2	14,3	12/13	37/13,5	16	16
	 <p>hose connection</p>		LP-004-1-SL004-...	4 mm		○	○		12			37/—	18	16
LP-004-1-SL006-...		6 mm	●	●	●		12			44/—	25	16	11	

characteristic features:

- extended version
- non squirt feature
- stainless steel version 1.4404/1.4571 or similar in smooth variant with gripping grooves instead of knurling

materials:

- standard:**
 21 = brass, passivated
 01 = stainless steel 1.4404/1.4571 or similar

seal qualities:



- 1 = NBR
- 2 = FKM
- 4 = EPDM

optional features:

OV = without valve

Please note the technical data on pages 2 - 7, 32 - 33 and the max. working pressures on page 9

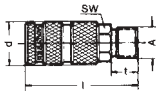
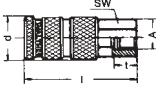
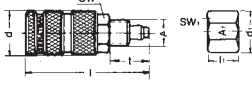
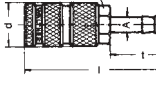
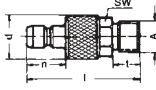
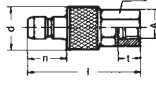
Availability: ● Short ○ Medium ○ Long

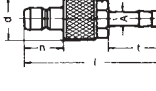
	Part No.	Connection A/A ₁	brass passivated	AISI 316 ti/1.4571	pipe od	n.b.	d	d ₁	AF/AF ₁	l	l ₁	t	n	Weight [g]
Self sealing couplings	 <p>British standard pipe parallel (BSPP) male thread to DIN ISO 228</p>	LV-004-0-WR010-...-	BSP 1/8"	●	○		18		14/-	50,5		8		55
		LV-004-0-WR013-...-	BSP 1/4"	●	○		18		14/-	51,5		11		60
	 <p>British standard pipe parallel (BSPP) female thread to DIN ISO 228</p>	LV-004-0-WR510-...-	BSP 1/8"	●	○		18		14/-	50,5		9		60
		 <p>re-usable hose connection with swivel nut for plastic pipes</p>	LV-004-0-SW004-...-	OD 6 ID 4 mm	●		6	4	18	14,3	14/13	56,5	13,5	16
	 <p>hose connection</p>		LV-004-0-SL004-...-	4 mm	●	○		18		14/-	58,5		18	
		LV-004-0-SL006-...-	6 mm	●	○		18		14/-	65,5		25		55
Self sealing adaptors	 <p>British standard pipe parallel (BSPP) male thread to DIN ISO 228</p>	LV-004-2-WR010-...-	BSP 1/8"	●	○		18		14/-	50		8	21	38
		LV-004-2-WR013-...-	BSP 1/4"	●	○		18		14/-	51		11	21	43
	 <p>British standard pipe parallel (BSPP) female thread to DIN ISO 228</p>	LV-004-2-WR510-...-	BSP 1/8"	●	○		18		14/-	50		9	21	42
		 <p>re-usable hose connection with swivel nut for plastic pipes</p>	LV-004-2-SW004-...-	OD 6 ID 4 mm M 10 x 1	●			18	14,3	14/13	56	13,5	16	21
	 <p>hose connection</p>		LV-004-2-SL004-...-	4 mm	●	○		18		14/-	58		18	21
		LV-004-2-SL006-...-	6 mm	●	○		18		14/-	65		25	21	38

characteristic features:
 - non squirt feature
 - can be coupled with type KL-006 (plastic version)
 - stainless steel version 1.4404/1.4571 or similar
 in smooth variant with gripping grooves instead of knurling

optional features:
 OV = without valve
 SI = with additional axial safety lock
 (outer diameter 29 mm)
 VH = with locking aid

materials:
standard:
 11 = steel, zinc plated
 21 = brass, passivated
 22 = brass, chrome plated
 01 = stainless steel 1.4404/1.4571 or similar

special materials:
 13 = steel, chem. nickel plated
 24 = brass, chem. nickel plated
 31 = aluminium anodized silver

seal qualities:
 1 = NBR
 2 = FKM
 4 = EPDM

Please note the technical data on pages 2 - 7, 32 - 33 and the max. working pressures on page 9

Availability: ● Short ○ Medium ○ Long

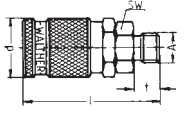
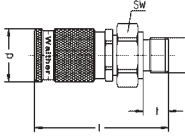
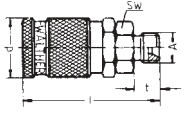
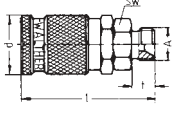
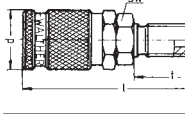
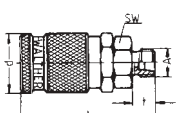
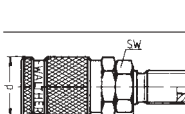
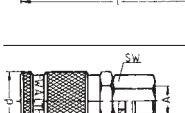
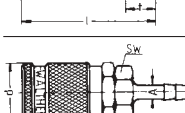
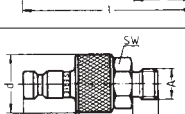
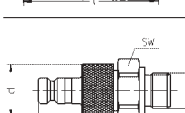
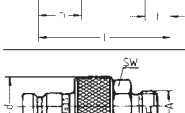
	Part No.	Connec- tion A	steel zinc	brass	brass	AISI 316 Ti/	series	pipe OD	n. b.	d	SW	l	t	n	weight [g]		
			plated	passivated	chrome plated	1.4571											
Self sealing couplings	 <p>British standard pipe parallel (BSPP) male thread to DIN ISO 228</p>	LP-006-0-WR013-... LP-006-0-WR017-... LP-006-0-WR021-...	BSPP 1/4" BSPP 3/8" BSPP 1/2"	● ● ●	● ● ●	● ● ●	○ ○ ○			25 25 25	19 19 22	58 59 62	11 12 15		110 120 140		
		 <p>British standard pipe parallel (BSPP) male thread to DIN ISO 228, sealing profile "E" to DIN 3852-11 for o-ring or sealing ring.</p>	LP-006-0-WE017-...	BSPP 3/8"	●						25	27	64	12		160	
		 <p>BSPP male thread to DIN ISO 228/BS 5200 with 60° sealing cone</p>	LP-006-0-VR013-... LP-006-0-VR017-...	BSPP 1/4" BSPP 3/8"	○ ○			○ ○			6 6	25 25	19 19	58 59	11 12		110 120
	 <p>metric male thread with 60° sealing cone to DIN 7631</p>	LP-006-0-D0614-...	M 14 x 1,5	●			○			6	25	19	57	10		110	
	 <p>metric male thread with 60° sealing cone to DIN 7631, extended thread for bulkhead mounting, max. thickness 10 mm</p>	LP-006-0-DV008-...	M 14 x 1,5	○			○			6	25	19	79	32		130	
	 <p>metric male thread with 24° sealing cone to DIN 2353 (light duty series L, heavy duty series S)</p>	LP-006-0-L0612-... LP-006-0-L0814-... LP-006-0-L1016-... LP-006-0-L1218-... LP-006-0-S0816-... LP-006-0-S1018-... LP-006-0-S1220-...	M 12 x 1,5 M 14 x 1,5 M 16 x 1,5 M 18 x 1,5 M 16 x 1,5 M 18 x 1,5 M 20 x 1,5	● ● ● ○ ○ ● ●			○ ○ ○ ○ ○ ○ ○	L L L L S S S	6 8 10 12 8 10 12	4 6 8 10	25 25 25 25 25 25 25	19 19 19 19 19 19 22	57 57 58 58 59 59 59	10 10 11 11 12 12 12		110 110 110 110 120 120 130	
		 <p>metric male thread with 24° sealing cone to DIN 2353 (light duty series L, heavy duty series S), extended thread, max. bulkhead thickness 10 mm</p>	LP-006-0-LV008-... LP-006-0-XX211-...	M 14 x 1,5 M 16 x 1,5	● ○			○ ○	L L	8 10	6 8	25 25	19 19	79 79	32 32		130 140
		 <p>British standard pipe parallel (BSPP) female thread to DIN ISO 228</p>	LP-006-0-WR513-... LP-006-0-WR517-...	BSPP 1/4" BSPP 3/8"	● ●	● ●	● ●	○ ○			25 25	19 22	57 58	13 14		120 120	
			 <p>hose connection</p>	LP-006-0-SL006-... LP-006-0-SL009-... LP-006-0-SL011-... LP-006-0-SL013-...	6 mm 9 mm 11 mm 13 mm	● ● ● ●	● ● ● ●	● ● ● ●	○ ○ ○ ○			25 25 25 25	19 19 19 19	72 77 77 77	25 30 30 30		110 110 120 130
		Self sealing adaptors	 <p>British standard pipe parallel (BSPP) male thread to DIN ISO 228</p>	LP-006-2-WR013-... LP-006-2-WR017-... LP-006-2-WR021-...	BSPP 1/4" BSPP 3/8" BSPP 1/2"	● ● ●	● ● ●	● ● ●	○ ○ ○			25 25 25	19 19 22	56 57 60	11 12 15	20 20 20	85 90 110
 <p>British standard pipe parallel (BSPP) male thread to DIN ISO 228, sealing profile "E" to DIN 3852-11 for o-ring or sealing ring.</p>				LP-006-2-WE017-...	BSPP 3/8"	●						25	27	62	12	20	130
 <p>BSPP male thread to DIN ISO 228/BS 5200 with 60° sealing cone</p>	LP-006-2-VR013-... LP-006-2-VR017-...			BSPP 1/4" BSPP 3/8"	○ ○			○ ○			6 6	25 25	19 19	56 57	11 12	20 20	85 90

Availability: ● Short ● Medium ○ Long

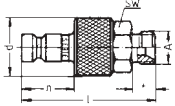
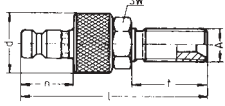
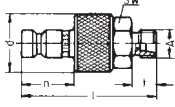
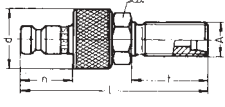
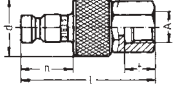
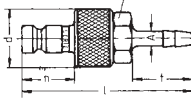
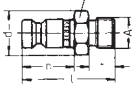
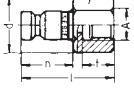
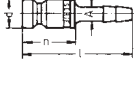
	Part No.	Conne- tion A	steel zinc	brass	passivated	brass chrome	AISI 316 ti/ 1.4571	series	pipe OD	n. b.	d	SW	l	t	n	weight [g]	
			plated			plated											
Self sealing adaptors	 metric male thread with 60° sealing cone to DIN 7631	LP-006-2-D0614-...-	M 14 x 1,5	●				○			6	25	19	55	10	20	85
	 metric male thread with 60° sealing cone to DIN 7631, extended thread for bulkhead mounting, max. thickness 10 mm	LP-006-2-DV008-...-	M 14 x 1,5	○				○			6	25	19	77	32	20	100
	 metric male thread with 24° sealing cone to DIN 2353 (light duty series L, heavy duty series S)	LP-006-2-L0612-...-	M 12 x 1,5	●				○	L	6	4	25	19	55	10	20	80
		LP-006-2-L0814-...-	M 14 x 1,5	●				○	L	8	6	25	19	55	10	20	85
		LP-006-2-L1016-...-	M 16 x 1,5	●				○	L	10	8	25	19	56	11	20	85
		LP-006-2-L1218-...-	M 18 x 1,5	○				○	L	12	10	25	19	56	11	20	85
		LP-006-2-S0816-...-	M 16 x 1,5	○				○	S	8	4	25	19	57	12	20	90
		LP-006-2-S1018-...-	M 18 x 1,5	●				○	S	10	6	25	19	57	12	20	90
	LP-006-2-S1220-...-	M 20 x 1,5	●				○	S	12	8	25	22	57	12	20	100	
	 metric male thread with 24° sealing cone to DIN 2353 (light duty series L, heavy duty series S), extended thread, max. bulkhead thickness 10 mm	LP-006-2-LV008-...-	M 14 x 1,5	●				○	L	8	6	25	19	77	32	20	100
LP-006-2-XX211-...-		M 16 x 1,5	○				○	L	10	8	25	19	77	32	20	110	
 British standard pipe parallel (BSPP) female thread to DIN ISO 228	LP-006-2-WR513-...-	BSPP 1/4"	●	●	●	○					25	19	55	13	20	90	
	LP-006-2-WR517-...-	BSPP 3/8"	●	●	●	○					25	22	56	14	20	95	
 hose connection	LP-006-2-SL006-...-	6 mm	●	●	●	○					25	19	70	25	20	80	
	LP-006-2-SL009-...-	9 mm	●	●	●	○					25	19	75	30	20	85	
	LP-006-2-SL011-...-	11 mm	●	●	●	○					25	19	75	30	20	90	
	LP-006-2-SL013-...-	13 mm	●	●	●	○					25	19	75	30	20	100	
 British standard pipe parallel (BSPP) male thread to DIN ISO 228	LP-006-1-WR010-..	BSPP 1/8"	●	○	○	○					15,5	14	34	8	20	22	
	LP-006-1-WR013-..	BSPP 1/4"	●	●	●	○					15,5	14	38	11	20	25	
	LP-006-1-WR017-..	BSPP 3/8"	●	●	○	○					21	19	40,5	12	20	39	
 British standard pipe parallel (BSPP) female thread to DIN ISO 228	LP-006-1-WR510-..	BSPP 1/8"	○	○	○	○					16,5	15	31	9	20	20	
	LP-006-1-WR513-..	BSPP 1/4"	●	●	●	○					18,9	17	36	13	20	28	
	LP-006-1-WR517-..	BSPP 3/8"	●	●	●	○					24	22	38	14	20	44	
 hose connection	LP-006-1-SL006-...	6 mm	●	●	●	○					12		46		20	16	
	LP-006-1-SL009-...	9 mm	●	●	●	○					12		51		20	20	
	LP-006-1-SL011-...	11 mm	●	●	●	○					16		53		20	31	
	LP-006-1-SL013-...	13 mm	●	●	●	○					16		53		20	41	

characteristic features:
 - stainless steel version 1.4404/1.4571 or similar
 in smooth variant with gripping grooves instead
 knurling

optional features:
 OV = without valve

materials:
 standard:
 11 = steel, zinc plated
 21 = brass, passivated
 22 = brass, chrome plated
 01 = stainless steel 1.4404/1.4571 or similar

special materials:
 31 = aluminium anodized silver
 13 = steel, chem. nickel plated
 24 = brass, chem. nickel plated

seal qualities:
 1 = NBR
 2 = FKM
 4 = EPDM

Please note the
 technical data on
 pages 2 - 7, 32 - 33 and the
 max. working pressures
 on page 9

Availability: ● Short ○ Medium ○ Long

Self sealing couplings

Self sealing adaptors

Diagram	Description	Part No.	Connec- tion A	steel zinc	brass	brass chrome	AISI 316 Ti/	series	pipe OD	n. b.	d	SW	l	t	n	weight [g]	
				plated	passivated	plated	1.4571										
	British standard pipe parallel (BSPP) male thread to DIN ISO 228	SP-006-0-WR013-...	BSPP 1/4"	●	●	●	○				22	19	58	11		90	
		SP-006-0-WR017-...	BSPP 3/8"	●	●	●	○					22	19	59	12		95
		SP-006-0-WR021-...	BSPP 1/2"	●	●	●	○						22	22	62	15	
	British standard pipe parallel (BSPP) male thread to DIN ISO 228, sealing profile "E" to DIN 3852-11 for o-ring or sealing ring.	SP-006-0-WE017-...	BSPP 3/8"	●							22	27	64	12		130	
	BSPP male thread to DIN ISO 228/BS 5200 with 60° sealing cone	SP-006-0-VR013-...	BSPP 1/4"	○			○			6	22	19	58	11		90	
		SP-006-0-VR017-...	BSPP 3/8"	○			○			6	22	19	59	12			95
	metric male thread with 60° sealing cone to DIN 7631	SP-006-0-D0614-...	M 14 x 1,5	○			○			6	22	19	57	10		85	
	metric male thread with 60° sealing cone to DIN 7631, extended thread for bulkhead mounting, max. thickness 10 mm	SP-006-0-DV008-...	M 14 x 1,5	○			○			6	22	19	79	32		105	
	metric male thread with 24° sealing cone to DIN 2353 (light duty series L, heavy duty series S)	SP-006-0-L0612-...	M 12 x 1,5	●			○	L	6	4	22	19	57	10		85	
		SP-006-0-L0814-...	M 14 x 1,5	●			○	L	8	6	22	19	57	10		85	
		SP-006-0-L1016-...	M 16 x 1,5	●			○	L	10	8	22	19	58	11		90	
		SP-006-0-L1218-...	M 18 x 1,5	○			○	L	12	10	22	19	58	11		90	
		SP-006-0-S0816-...	M 16 x 1,5	○			○	S	8	4	22	19	59	12		90	
		SP-006-0-S1018-...	M 18 x 1,5	○			○	S	10	6	22	19	59	12		95	
		SP-006-0-S1220-...	M 20 x 1,5	●			○	S	12	8	22	22	59	12		100	
	metric male thread with 24° sealing cone to DIN 2353 (light duty series L, heavy duty series S), extended thread, max. bulkhead thickness 10 mm	SP-006-0-LV008-...	M 14 x 1,5	●			○	L	8	6	22	19	79	32		100	
		SP-006-0-XX211-...	M 16 x 1,5	○			○	L	10	8	22	19	79	32		110	
	British standard pipe parallel (BSPP) female thread to DIN ISO 228	SP-006-0-WR513-...	BSPP 1/4"	●	●	●	○				22	19	57	13		95	
		SP-006-0-WR517-...	BSPP 3/8"	●	●	●	○					22	22	58	14		100
	hose connection	SP-006-0-SL006-...	6 mm	●	●	●	○				22	19	72	25		85	
		SP-006-0-SL009-...	9 mm	●	●	●	○					22	19	77	30		90
		SP-006-0-SL011-...	11 mm	●	●	●	○					22	19	77	30		95
		SP-006-0-SL013-...	13 mm	●	●	●	○					22	19	77	30		110
	British standard pipe parallel (BSPP) male thread to DIN ISO 228	SP-006-2-WR013-...	BSPP 1/4"	●	●	●	○				22	19	56	11	20	70	
		SP-006-2-WR017-...	BSPP 3/8"	●	●	●	○					22	19	57	12	20	75
		SP-006-2-WR021-...	BSPP 1/2"	●	●	●	○					22	22	60	15	20	100
	British standard pipe parallel (BSPP) male thread to DIN ISO 228, sealing profile "E" to DIN 3852-11 for o-ring or sealing ring.	SP-006-2-WE017-...	BSPP 3/8"	●							22	27	62	12	20	110	
	BSPP male thread to DIN ISO 228/BS 5200 with 60° sealing cone	SP-006-2-VR013-...	BSPP 1/4"	○			○			6	22	19	56	11	20	70	
		SP-006-2-VR017-...	BSPP 3/8"	○			○			6	22	19	57	12	20	75	

Availability: ● Short ○ Medium ○ Long

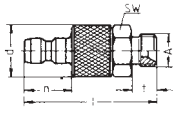
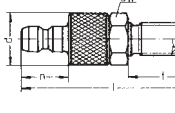
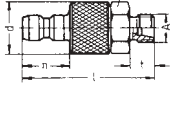
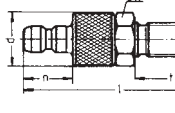
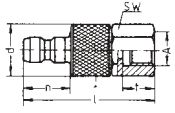
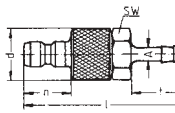
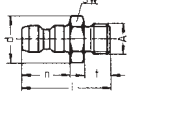
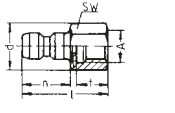
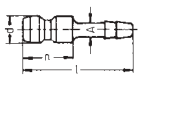
		Part No.	Conne- tion A	steel zinc plated	brass passivated	brass chrome plated	AISI 316 Ti/ 1.4571	series	pipe OD	n. b.	d	SW	l	t	n	weight [g]
Self sealing adaptors		SP-006-2-D0614-...-	M 14 x 1,5	○			○			6	22	19	55	10	20	70
		SP-006-2-DV008-...-	M 14 x 1,5	○			○			6	22	19	77	32	20	90
		SP-006-2-L0612-...-	M 12 x 1,5	●			○	L	6	4	22	19	55	10	20	70
		SP-006-2-L0814-...-	M 14 x 1,5	●			○	L	8	6	22	19	55	10	20	70
		SP-006-2-L1016-...-	M 16 x 1,5	●			○	L	10	8	22	19	56	11	20	70
		SP-006-2-L1218-...-	M 18 x 1,5	○			○	L	12	10	22	19	56	11	20	70
		SP-006-2-S0816-...-	M 16 x 1,5	○			○	S	8	4	22	19	57	12	20	75
		SP-006-2-S1018-...-	M 18 x 1,5	○			○	S	10	6	22	19	57	12	20	75
		SP-006-2-S1220-...-	M 20 x 1,5	●			○	S	12	8	22	22	57	12	20	85
		SP-006-2-LV008-...-	M 14 x 1,5	●			○	L	8	6	22	19	77	32	20	85
SP-006-2-XX211-...-		M 16 x 1,5	○			○	L	10	8	22	19	77	32	20	95	
	SP-006-2-WR513-...-	BSPP 1/4"	●	●	●	○				22	19	55	13	20	75	
	SP-006-2-WR517-...-	BSPP 3/8"	●	●	●	○				22	22	56	14	20	80	
	SP-006-2-SL006-...-	6 mm	●	●	●	○				22	19	70	25	20	70	
	SP-006-2-SL009-...-	9 mm	●	●	●	○				22	19	75	30	20	70	
	SP-006-2-SL011-...-	11 mm	●	●	●	○				22	19	75	30	20	80	
	SP-006-2-SL013-...-	13 mm	●	●	●	○				22	19	75	30	20	90	
Thru type adaptors		SP-006-1-WR010-...-	BSPP 1/8"	●	●	●	○			15,5	14	34	8	20	20	
		SP-006-1-WR013-...-	BSPP 1/4"	●	●	●	○			15,5	14	37	11	20	23	
		SP-006-1-WR017-...-	BSPP 3/8"	●	●	●	○			21,9	19	38	12	20	37	
		SP-006-1-WR513-...-	BSPP 1/4"	●	●	●	○				19,6	17	36	13	20	26
		SP-006-1-WR517-...-	BSPP 3/8"	●	●	●	○				24	22	37	14	20	40
		SP-006-1-SL006-...-	6 mm	●	●	●	○				11		46		20	13
		SP-006-1-SL009-...-	9 mm	●	●	●	○				11		51		20	18

characteristic features:
 - non squirt feature
 - stainless steel version 1.4404/1.4571 or similar
 in smooth variant with gripping grooves instead knurling

optional features:
 OV = without valve
 S = with additional axial safety lock
 (outer diameter 34 mm)
 VH = with locking aid

materials:
standard:
 11 = steel, zinc plated
 21 = brass, passivated
 22 = brass, chrome plated
 01 = stainless steel 1.4404/1.4571 or similar

special materials:
 13 = steel, chem. nickel plated
 24 = brass, chem. nickel plated

seal qualities:
 1 = NBR
 2 = FKM
 4 = EPDM

Please note the technical data on pages 2 - 7, 32 - 33 and the max. working pressures on page 9

Availability: ● Short ○ Medium ○ Long

Self sealing couplings

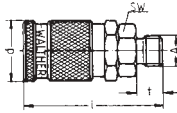
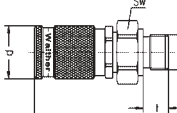
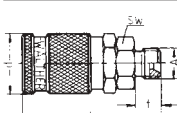
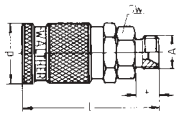
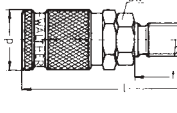
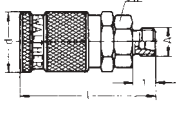
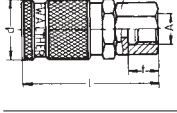
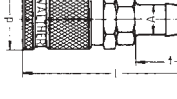
	Part No.	Connec- tion A	steel zinc plated	brass passivated	brass chrome plated	AISI 316 Ti/ 1.4571	series	pipe OD	n. b.	d	SW	l	t	n	weight [g]
 <p>British standard pipe parallel (BSPP) male thread to DIN ISO 228</p>	LP-007-0-WR017-... LP-007-0-WR021-...	BSPP 3/8" BSPP 1/2"	● ●	● ●	● ●	○ ○				30 30	24 24	68 71	12 15		200 210
	 <p>British standard pipe parallel (BSPP) male thread to DIN ISO 228, sealing profile "E" to DIN 3852-11 for o-ring or sealing ring.</p>	LP-007-0-WE017-...	BSPP 3/8"	●						30	27	71	12		220
 <p>BSPP male thread to DIN ISO 228/BS 5200 with 60° sealing cone</p>		LP-007-0-VR017-...	BSPP 3/8"	○					7	30	24	68	12		190
	 <p>metric male thread with 60° sealing cone to DIN 7631</p>	LP-007-0-D0816-...	M 16 x 1,5	○					8	30	24	67	11		200
 <p>metric male thread with 60° sealing cone to DIN 7631, extended thread for bulkhead mounting, max. thickness 10 mm</p>		LP-007-0-DV010-...	M 16 x 1,5	○					8	30	24	89,5	33,5		210
	 <p>metric male thread with 24° sealing cone to DIN 2353 (light duty series L, heavy duty series S)</p>	LP-007-0-L1016-... LP-007-0-L1218-... LP-007-0-S1018-... LP-007-0-S1220-...	M 16 x 1,5 M 18 x 1,5 M 18 x 1,5 M 20 x 1,5	● ● ● ●			○ ○ ○ ○	L L S S	10 12 10 12	8 10 6 8	30 30 30 30	24 24 24 24	67 67 68 68	11 11 12 12	
 <p>British standard pipe parallel (BSPP) female thread to DIN ISO 228</p>		LP-007-0-WR517-... LP-007-0-WR521-...	BSPP 3/8" BSPP 1/2"	● ●	● ●	● ○				30 30	24 27	68 71	14 17		210 230
		 <p>hose connection</p>	LP-007-0-SL009-... LP-007-0-SL011-... LP-007-0-SL013-...	9 mm 11 mm 13 mm	● ● ●	● ● ●	● ● ●	○ ○ ○			30 30 30	24 24 24	86 86 86	30 30 30	

Self sealing adaptors

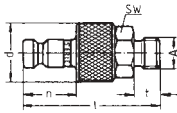
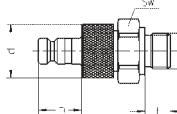
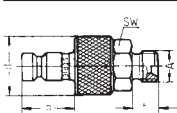
 <p>British standard pipe parallel (BSPP) male thread to DIN ISO 228</p>	LP-007-2-WR017-... LP-007-2-WR021-...	BSPP 3/8" BSPP 1/2"	● ●	● ●	● ○				30 30	24 24	66 69	12 15	23,3 23,3	150 170
	 <p>British standard pipe parallel (BSPP) male thread to DIN ISO 228, sealing profile "E" to DIN 3852-11 for o-ring or sealing ring.</p>	LP-007-2-WE017-...	BSPP 3/8"	●					30	27	69	12	23,3	170
 <p>BSPP male thread to DIN ISO 228/BS 5200 with 60° sealing cone</p>		LP-007-2-VR017-...	BSPP 3/8"	○					7	30	24	66	12	23,3

Availability: ● Short ● Medium ○ Long

	Part No.	Conne- tion A	steel zinc plated	brass passivated	brass chrome plated	AISI 316 ti/ 1.4571	series	pipe OD	n. b.	d	SW	l	t	n	weight [g]
Self sealing adaptors	LP-007-2-D0816-...-	M 16 x 1,5	○			○			8	30	24	65	11	23,3	150
	LP-007-2-DV010-...-	M 16 x 1,5	○			○			8	30	24	87,5	33,5	23,3	160
	LP-007-2-L1016-...-	M 16 x 1,5	●			○	L	10	8	30	24	65	11	23,3	140
	LP-007-2-L1218-...-	M 18 x 1,5	●			○	L	12	10	30	24	65	11	23,3	140
	LP-007-2-S1018-...-	M 18 x 1,5	●			○	S	10	6	30	24	66	12	23,3	150
	LP-007-2-S1220-...-	M 20 x 1,5	●			○	S	12	8	30	24	66	12	23,3	150
	LP-007-2-WR517-...-	BSPP 3/8"	●	●	●	●				30	24	66	14	23,3	160
	LP-007-2-WR521-...-	BSPP 1/2"	●	●	●	○				30	27	69	17	23,3	180
	LP-007-2-SL009-...-	9 mm	●	●	●	○				30	24	84	30	23,3	150
	LP-007-2-SL011-...-	11 mm	●	●	●	○				30	24	84	30	23,3	150
LP-007-2-SL013-...-	13 mm	●	●	●	●				30	24	84	30	23,3	160	
Thru type adaptors	LP-007-1-WR013-...-	BSPP 1/4"	●	○	○	○				18,9	17	40,5	11	23,3	35
	LP-007-1-WR017-...-	BSPP 3/8"	●	○	○	○				21	19	41,5	12	23,3	45
	LP-007-1-WR021-...-	BSPP 1/2"	●	●	●	○				26,7	24	44,5	15	23,3	70
	LP-007-1-WR513-...-	BSPP 1/4"	●	○	○	○				18,9	17	40,5	13	23,3	37
	LP-007-1-WR517-...-	BSPP 3/8"	●	●	●	○				24	22	41,5	14	23,3	55
	LP-007-1-WR521-...-	BSPP 1/2"	●	●	●	○				30	27	44,5	17	23,3	75
	LP-007-1-SL009-...-	9 mm	●	●	○	○						54,5	30	23,3	29
	LP-007-1-SL011-...-	11 mm	●	●	●	○				14		56,5	30	23,3	37
	LP-007-1-SL013-...-	13 mm	●	●	●	○				18		56,5	30	23,3	46

Series LP

characteristic features:
 - stainless steel version 1.4404/1.4571 or similar
 in smooth variant with gripping grooves instead
 knurling

optional features:
 OV = without valve

materials:
 standard:
 11 = steel, zinc plated
 21 = brass, passivated
 22 = brass, chrome plated
 01 = stainless steel 1.4404/1.4571 or similar

special materials:
 13 = steel, chem. nickel plated
 24 = brass, chem. nickel plated

seal qualities:
 1 = NBR
 2 = FKM
 4 = EPDM

Please note the
 technical data on
 pages 2 - 7, 32 - 33 and the
 max. working pressures
 on page 9

Availability: ● Short ○ Medium ○ Long

Self sealing couplings

Self sealing adaptors

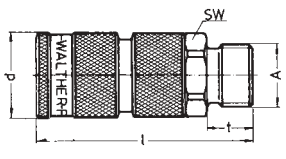
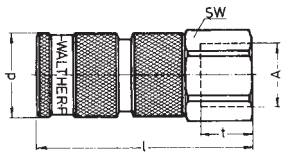
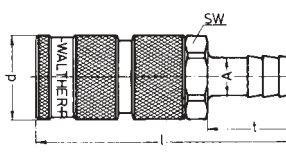
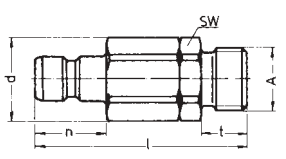
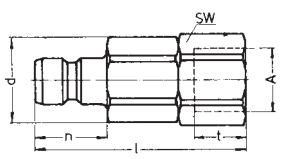
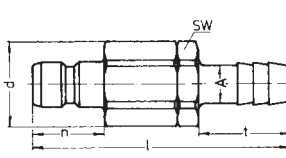
	Part No.	Connec- tion A	steel zinc	brass	brass chrome	AISI 316 Ti/	series	pipe OD	n. b.	d	SW	l	t	n	weight [g]
			plated	passivated	plated	1.4571									
 <p>British stan- dard pipe parallel (BSPP) male thread to DIN ISO 228</p>	SP-009-0-WR017-...-Z02	BSPP 3/8"	●	●	○	○				28	25	71	12		180
	SP-009-0-WR021-...-Z02	BSPP 1/2"	●	●	○	○				28	25	71	15		190
 <p>British stan- dard pipe parallel (BSPP) fe- male thread to DIN ISO 228</p>	SP-009-0-WR521-...-Z02	BSPP 1/2"	●	●	○	○				28	27	71	17		200
 <p>hose connection</p>	SP-009-0-SL013-...-Z02	13 mm	●	●	○	○				28	25	86	30		180
 <p>British stan- dard pipe parallel (BSPP) male thread to DIN ISO 228</p>	SP-009-2-WR017-...-Z02	BSPP 3/8"	●	●	○	○				28	25	69,5	12	23,5	120
	SP-009-2-WR021-...-Z02	BSPP 1/2"	●	●	○	○				28	25	69,5	15	23,5	130
 <p>British stan- dard pipe parallel (BSPP) fe- male thread to DIN ISO 228</p>	SP-009-2-WR521-...-Z02	BSPP 1/2"	●	●	○	○				28	27	69,5	17	23,5	140
 <p>hose connection</p>	SP-009-2-SL013-...-Z02	13 mm	●	●	○	○				28	25	84,5	30	23,5	130

Availability: ● Short ◐ Medium ○ Long

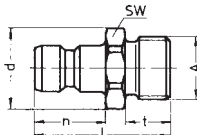
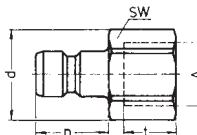
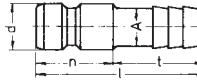
	Part No.	Conne- tion A	steel zinc	brass	passivated	brass chrome	AISI 316 ti/ 1.4571	series	pipe OD	n. b.	d	SW	l	t	n	weight [g]	
			plated			plated											
<p style="writing-mode: vertical-rl; transform: rotate(180deg);">Thru type adaptors</p>  <p>British standard pipe parallel (BSPP) male thread to DIN ISO 228</p>	SP-009-1-WR017-... SP-009-1-WR021-...	BSPP 3/8" BSPP 1/2"	● ●	◐ ◐	○ ○	○ ○					21,9 24	19 22	41,5 46,5	12 15	23,5 23,5	40 60	
	 <p>British standard pipe parallel (BSPP) female thread to DIN ISO 228</p>	SP-009-1-WR521-...	BSPP 1/2"	●	○	○	○					30	27	45	17	23,5	75
	 <p>hose connection</p>	SP-009-1-SL013-..	13 mm	○	●	○	○					15		55	30	23,5	37

characteristic features:
 - non squirt feature
 - can be coupled with type KL-012 (plastic version)
 - stainless steel version 1.4404/1.4571 or similar
 in smooth variant with gripping grooves instead of knurling

optional features:
 OV = without valve
 SI = with additional axial safety lock
 (outer diameter 44 mm)
 VH = with locking aid

materials:
standard:
 11 = steel, zinc plated
 21 = brass, passivated
 22 = brass, chrome plated
 01 = stainless steel 1.4404/1.4571 or similar

special materials:
 13 = steel, chem. nickel plated
 24 = brass, chem. nickel plated

seal qualities:
 1 = NBR
 2 = FKM
 4 = EPDM

Please note the technical data on pages 2 - 7, 32 - 33 and the max. working pressures on page 9

Availability: ● Short ○ Medium ○ Long

Self sealing couplings

Self sealing adaptors

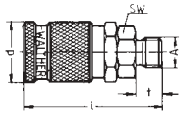
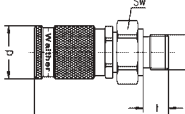
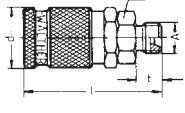
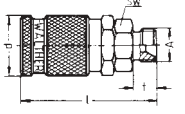
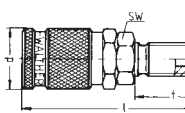
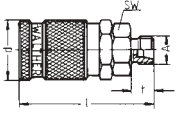
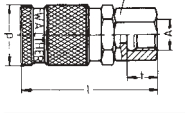
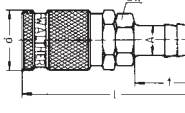
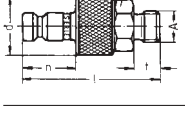
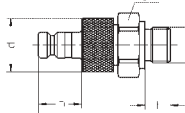
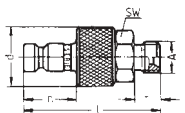
	Part No.	Connec- tion A	steel zinc plated	brass passivated	brass chrome plated	AISI 316 Ti/ 1.4571	series	pipe OD	n. b.	d	SW	l	t	n	weight [g]
 <p>British standard pipe parallel (BSPP) male thread to DIN ISO 228</p>	LP-012-0-WR021-...	BSPP 1/2"	●	●	●	○				40	32	82	15		380
	LP-012-0-WR026-...	BSPP 3/4"	●	●	●	○				40	32	84	17		410
	LP-012-0-WR033-...	BSPP 1"	●	○	○	○				40	36	88	20		470
 <p>British standard pipe parallel (BSPP) male thread to DIN ISO 228, sealing profile "E" to DIN 3852-11 for o-ring or sealing ring.</p>	LP-012-0-WE021-...	BSPP 1/2"	●							40	32	84	14		390
 <p>BSPP male thread to DIN ISO 228/BS 5200 with 60° sealing cone</p>	LP-012-0-VR021-...	BSPP 1/2"	●			○		12	40	32	82	15		380	
	LP-012-0-VR026-...	BSPP 3/4"	●			○		12	40	32	84	17			400
 <p>metric male thread with 60° sealing cone to DIN 7631</p>	LP-012-0-D1018-...	M 18 x 1,5	●					10	40	32	78	11		370	
	LP-012-0-D1222-...	M 22 x 1,5	●			○		12	40	32	79	12			380
 <p>metric male thread with 60° sealing cone to DIN 7631, extended thread for bulkhead mounting, max. thickness 10 mm</p>	LP-012-0-DV015-...	M 22 x 1,5	○			○		12	40	32	106	39		430	
 <p>metric male thread with 24° sealing cone to DIN 2353 (light duty series L, heavy duty series S)</p>	LP-012-0-L1218-...	M 18 x 1,5	●			○	L	12	10	40	32	78	11	370	
	LP-012-0-L1522-...	M 22 x 1,5	●			○	L	15	12	40	32	79	12	380	
	LP-012-0-S1624-...	M 24 x 1,5	●			○	S	16	12	40	32	81	14	390	
 <p>British standard pipe parallel (BSPP) female thread to DIN ISO 228</p>	LP-012-0-WR521-...	BSPP 1/2"	●	●	●	○				40	32	81	17	420	
	LP-012-0-WR526-...	BSPP 3/4"	●	●	●	○				40	32	83	19		400
 <p>hose connection</p>	LP-012-0-SL016-...	16 mm	●	●	●	○				40	32	102	35	390	
	LP-012-0-SL019-...	19 mm	●	●	●	○				40	32	102	35		410
 <p>British standard pipe parallel (BSPP) male thread to DIN ISO 228</p>	LP-012-2-WR021-...	BSPP 1/2"	●	●	○	○				40	32	80	15	29,5	290
	LP-012-2-WR026-...	BSPP 3/4"	●	●	○	○				40	32	82	17	29,5	320
	LP-012-2-WR033-...	BSPP 1"	●	○	○	○				40	36	86	20	29,5	380
 <p>British standard pipe parallel (BSPP) male thread to DIN ISO 228, sealing profile "E" to DIN 3852-11 for o-ring or sealing ring.</p>	LP-012-2-WE021-...	BSPP 1/2"	●							40	32	82	14	29,5	300
 <p>BSPP male thread to DIN ISO 228/BS 5200 with 60° sealing cone</p>	LP-012-2-VR021-...	BSPP 1/2"	●			○		12	40	32	80	15	29,5	290	
	LP-012-2-VR026-...	BSPP 3/4"	●			○		12	40	32	82	17	29,5		310

Availability: ● Short ● Medium ○ Long

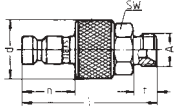
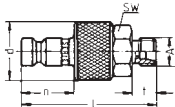
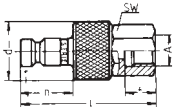
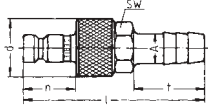
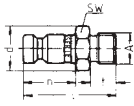
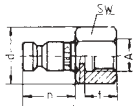
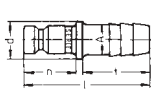
	Part No.	Conne- tion A	steel zinc plated	brass passivated	brass chrome plated	AISI 316 ti/ 1.4571	series	pipe OD	n. b.	d	SW	l	t	n	weight [g]	
Self sealing adaptors	 <p>metric male thread with 60° sealing cone to DIN 7631</p>	LP-012-2-D1018-... LP-012-2-D1222-...	M 18 x 1,5 M 22 x 1,5	● ●					10 12	40 40	32 32	76 77	11 12	29,5 29,5	280 290	
		LP-012-2-DV015-...	M 22 x 1,5	○						12	40	32	104	39	29,5	340
	 <p>metric male thread with 24° sealing cone to DIN 2353 (light duty series L, heavy duty series S)</p>	LP-012-2-L1218-... LP-012-2-L1522-... LP-012-2-S1624-...	M 18 x 1,5 M 22 x 1,5 M 24 x 1,5	● ● ●				L L S	12 15 16	10 12 12	40 40 40	32 32 32	76 77 79	11 12 14	29,5 29,5 29,5	280 290 290
		 <p>British standard pipe parallel (BSPP) female thread to DIN ISO 228</p>	LP-012-2-WR521-... LP-012-2-WR526-...	BSPP 1/2" BSPP 3/4"	● ●	● ●	● ●	○ ○			40 40	32 32	79 81	17 19	29,5 29,5	330 310
			 <p>hose connection</p>	LP-012-2-SL016-... LP-012-2-SL019-...	16 mm 19 mm	● ●	● ●	● ●	○ ○			40 40	32 32	100 100	35 35	29,5 29,5
Thru type adaptors	 <p>British standard pipe parallel (BSPP) male thread to DIN ISO 228</p>	LP-012-1-WR017-... LP-012-1-WR021-... LP-012-1-WR026-...	BSPP 3/8" BSPP 1/2" BSPP 3/4"	● ● ●	○ ● ●	○ ○ ○	○ ○ ○			30 30 33	27 27 30	49,5 54,5 54,5	12 15 17	29,5 29,5 29,5	90 100 140	
		 <p>British standard pipe parallel (BSPP) female thread to DIN ISO 228</p>	LP-012-1-WR521-... LP-012-1-WR526-...	BSPP 1/2" BSPP 3/4"	● ●	○ ○	○ ○	○ ○			30 35,5	27 32	50,5 52,5	17 19	29,5 29,5	100 120
			 <p>hose connection</p>	LP-012-1-SL013-... LP-012-1-SL016-... LP-012-1-SL019-...	13 mm 16 mm 19 mm	● ● ●	● ○ ●	● ○ ●	○ ○ ○			21 21 25		61 66 68,5	30 35 35	29,5 29,5 29,5

Series LP

characteristic features:
 - non squirt feature
 - stainless steel version 1.4404/1.4571 or similar
 in smooth variant with gripping grooves instead of knurling

optional features:
 GG= with ring grips (cast aluminium)
 OV= without valve
 SI = with additional axial safety lock
 (outer diameter 58 mm)
 VH= with locking aid

materials:
standard:
 11 = steel, zinc plated
 21 = brass, passivated
 22 = brass, chrome plated
 01 = stainless steel 1.4404/1.4571 or similar

special materials:
 13 = steel, chem. nickel plated
 24 = brass, chem. nickel plated



seal qualities:
 1 = NBR
 2 = FKM
 4 = EPDM

Please note the technical data on pages 2 - 7, 32 - 33 and the max. working pressures on page 9

Availability: ● Short ○ Medium ○ Long

Self sealing couplings

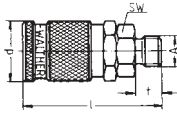
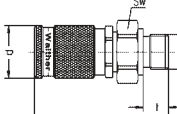
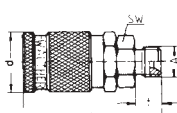
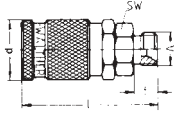
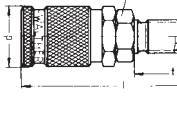
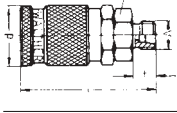
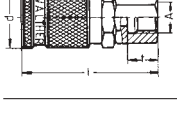
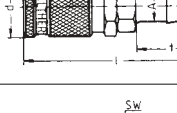
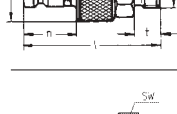
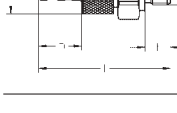
Self sealing adaptors

	Part No.	Connec- tion A	steel zinc plated	brass passivated	brass chrome plated	AISI 316 Ti/ 1.4571	series	pipe OD	n. b.	d	SW	l	t	n	weight [g]
 <p>British standard pipe parallel (BSPP) male thread to DIN ISO 228</p>	LP-019-0-WR026-...-	BSPP 3/4"	●	○	○	○				54	46	100	17		840
	LP-019-0-WR033-...-	BSPP 1"	●	●	●	○				54	46	103	20		870
 <p>British standard pipe parallel (BSPP) male thread to DIN ISO 228, sealing profile "E" to DIN 3852-11 for o-ring or sealing ring.</p>	LP-019-0-WE026-...-	BSPP 3/4"	○							54	46	102	16		850
	 <p>BSPP male thread to DIN ISO 228/BS 5200 with 60° sealing cone</p>	LP-019-0-VR026-...-	BSPP 3/4"	○					19	54	46	100	17		830
LP-019-0-VR033-...-		BSPP 1"	○					19	54	46	103	20		870	
 <p>metric male thread with 60° sealing cone to DIN 7631</p>	LP-019-0-D1526-...-	M 26 x 1,5	○						15	54	46	95	12		830
	LP-019-0-D1930-...-	M 30 x 1,5	○						19	54	46	97	14		830
 <p>metric male thread with 60° sealing cone to DIN 7631, extended thread for bulkhead mounting, max. thickness 10 mm</p>	LP-019-0-DV022-...-	M 30 x 1,5	○						19	54	46	128	45		920
	 <p>metric male thread with 24° sealing cone to DIN 2353 (light duty series L, heavy duty series S)</p>	LP-019-0-L1826-...-	M 26 x 1,5	○				L	18	16	54	46	95	12	
LP-019-0-L2230-...-		M 30 x 2	○				L	22	20	54	46	97	14		830
LP-019-0-S2030-...-		M 30 x 2	○				S	20	16	54	46	99	16		850
LP-019-0-S2536-...-		M 36 x 2	○				S	25	20	54	46	101	18		860
 <p>British standard pipe parallel (BSPP) female thread to DIN ISO 228</p>	LP-019-0-WR526-...-	BSPP 3/4"	●	●	○					54	46	94	19		890
	LP-019-0-WR533-...-	BSPP 1"	●	●	○					54	46	98	23		880
 <p>hose connection</p>	LP-019-0-SL019-...-	19 mm	○	○	○					54	46	118	35		850
	LP-019-0-SL025-...-	25 mm	○	○	○					54	46	123	40		870
	LP-019-0-SL028-...-	28 mm	○	○	○					54	46	128	45		930
 <p>British standard pipe parallel (BSPP) male thread to DIN ISO 228</p>	LP-019-2-WR026-...-	BSPP 3/4"	●	○	○					54	46	96	17	32,5	690
	LP-019-2-WR033-...-	BSPP 1"	●	●	○					54	46	99	20	32,5	720
 <p>British standard pipe parallel (BSPP) male thread to DIN ISO 228, sealing profile "E" to DIN 3852-11 for o-ring or sealing ring.</p>	LP-019-2-WE026-...-	BSPP 3/4"	○							54	46	98	16	32,5	700
	 <p>BSPP male thread to DIN ISO 228/BS 5200 with 60° sealing cone</p>	LP-019-2-VR026-...-	BSPP 3/4"	○					19	54	46	96	17	32,5	690
LP-019-2-VR033-...-		BSPP 1"	○					19	54	46	99	20	32,5	720	

Availability: ● Short ● Medium ○ Long

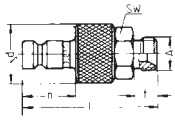
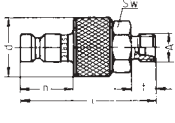
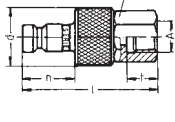
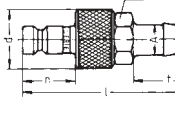
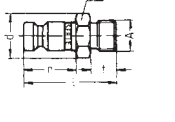
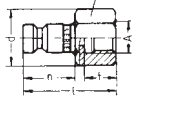
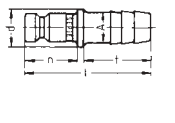
	Part No.	Conne- tion A	steel zinc	brass	passivated	brass chrome	AISI 316 ti/ 1.4571	series	pipe OD	n. b.	d	SW	l	t	n	weight [g]	
			plated			plated											
Self sealing adaptors	 <p>metric male thread with 60° sealing cone to DIN 7631</p>	LP-019-2-D1526-... LP-019-2-D1930-...	M 26 x 1,5 M 30 x 1,5	● ●			○ ○			15 19	54 54	46 46	91 93	12 14	32,5 32,5	680 680	
		LP-019-2-DV022-...	M 30 x 1,5	○			○			19	54	46	124	45	32,5	770	
	 <p>metric male thread with 24° sealing cone to DIN 2353 (light duty series L, heavy duty series S)</p>	LP-019-2-L1826-... LP-019-2-L2230-... LP-019-2-S2030-... LP-019-2-S2536-...	M 26 x 1,5 M 30 x 2 M 30 x 2 M 36 x 2	● ● ● ●			○ ○ ○ ○	L L S S	18 22 20 25	16 20 16 20	54 54 54 54	46 46 46 46	91 93 95 97	12 14 16 18	32,5 32,5 32,5 32,5	680 670 690 710	
		 <p>British standard pipe parallel (BSPP) female thread to DIN ISO 228</p>	LP-019-2-WR526-... LP-019-2-WR533-...	BSPP 3/4" BSPP 1"	● ●	● ●	● ●	○ ○				54 54	46 46	90 94	19 23	32,5 32,5	740 730
			 <p>hose connection</p>	LP-019-2-SL019-... LP-019-2-SL025-... LP-019-2-SL028-...	19 mm 25 mm 28 mm	● ● ●	● ● ●	● ● ●	○ ○ ○				54 54 54	46 46 46	114 119 124	35 40 45	32,5 32,5 32,5
		 <p>British standard pipe parallel (BSPP) male thread to DIN ISO 228</p>		LP-019-1-WR021-... LP-019-1-WR026-... LP-019-1-WR033-...	BSPP 1/2" BSPP 3/4" BSPP 1"	● ● ●	● ● ●	● ● ●	○ ○ ○				40 40 40	36 36 36	57,5 59,5 62,5	15 17 20	32,5 32,5 32,5
 <p>British standard pipe parallel (BSPP) female thread to DIN ISO 228</p>	LP-019-1-WR526-... LP-019-1-WR533-...			BSPP 3/4" BSPP 1"	● ●	● ●	● ●	○ ○				40 45	36 41	57,5 61,5	19 23	32,5 32,5	240 250
	 <p>hose connection</p>		LP-019-1-SL019-... LP-019-1-SL025-...	19 mm 25 mm	● ●	○ ●	○ ●	○ ○				32 32		68,5 73,5	35 40	32,5 32,5	180 190

Series LP

optional features:
 SI = with additional axial safety lock
 (outer diameter 89 mm)
 GG = with ring grips (cast aluminium)

materials:
 standard:
 11 = steel, zinc plated
 21 = brass, passivated
 22 = brass, chrome plated
 01 = stainless steel 1.4404/1.4571 or similar

seal qualities:
 1 = NBR
 2 = FKM
 4 = EPDM



special materials:
 13 = steel, chem. nickel plated
 24 = brass, chem. nickel plated
 31 = aluminium anodized silver

Please note the technical data on pages 2 - 7, 32 - 33 and the max. working pressures on page 9

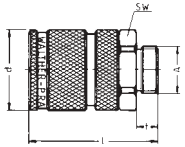
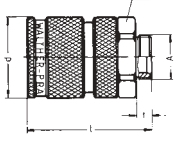
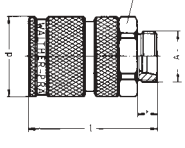
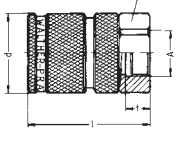
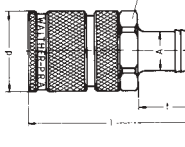
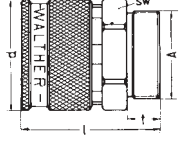
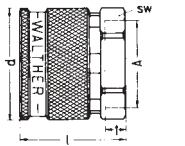
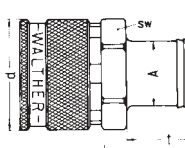
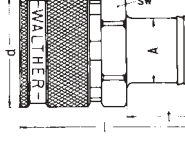
Availability: ● Short ○ Medium ○ Long

	Part No.	Connec- tion A	steel zinc	brass	brass	AISI 316 L/	series	pipe OD	n. b.	d	SW	l	t	n	weight [g]
			plated	passivated	chrome plated	1.4571									
Self sealing couplings	 <p>British standard pipe parallel (BSPP) male thread to DIN ISO 228</p>	LP-032-0-WR048-... LP-032-0-WR060-...	BSPP 1 1/2"	●	○	○				82	75	139	22		2930
				○	○	○									
	 <p>metric male thread with 60° sealing cone to DIN 7631</p>	LP-032-0-D3245-...	M 45 x 1,5	○	○	○				32	82	75	128	16	2720
				●	○	○									
	 <p>metric male thread with 24° sealing cone to DIN 2353 (light duty series L, heavy duty series S)</p>	LP-032-0-S3852-...	M 52 x 2	○	○	○				32	82	75	134	22	2770
●				○	○										
 <p>British standard pipe parallel (BSPP) female thread to DIN ISO 228</p>	LP-032-0-WR548-... LP-032-0-WR560-...	BSPP 1 1/2"	○	○	○					82	75	130	29		2760
			●	○	○										
Thru type couplings	 <p>hose connection</p>	LP-032-0-SL042-...	42 mm	○	○		○				82	75	178	61	
				○	○	○									
	 <p>British standard pipe parallel (BSPP) female thread to DIN ISO 228</p>	LP-032-4-WR048-... LP-032-4-WR060-...	BSPP 1 1/2"	○	○	○					82	70	109	22	2230
				○	○	○									
	 <p>British standard pipe parallel (BSPP) female thread to DIN ISO 228</p>	LP-032-4-WR542-... LP-032-4-WR548-... LP-032-4-WR560-...	BSPP 1 1/4"	○	○	○					82	70	89	25	2000
○				○	○										
 <p>British standard pipe parallel (BSPP) female thread to DIN ISO 228</p>	LP-032-4-WR542-... LP-032-4-WR548-... LP-032-4-WR560-...	BSPP 1 1/2"	○	○	○						82	70	89	29	1690
			○	○	○										
 <p>hose connection</p>	LP-032-4-SL042-...	42 mm	○	○	○						82	70	143	61	2260
○	○	○													

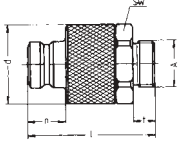
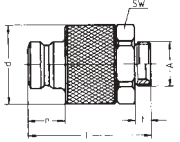
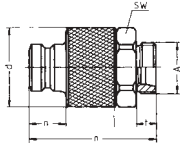
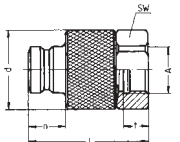
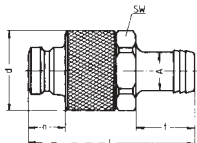
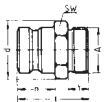
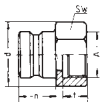
Availability: ● Short ● Medium ○ Long

	Part No.	Conne- tion A	steel zinc	brass	passivated	brass chrome	AlSi 316 ti/ 1,4571	series	pipe OD	n. b.	d	SW	l	t	n	weight [g]
			plated		brass	plated										
Self sealing adaptors	 <p>British standard pipe parallel (BSPP) male thread to DIN ISO 228</p>	LP-032-2-WR048-... LP-032-2-WR060-...	BSPP 1 1/2" BSPP 2"	● ○	● ○	● ○	○ ○				82 82	75 75	135,5 139,5	22 26	39 39	2460 2500
		 <p>metric male thread with 60° sealing cone to DIN 7631</p>	LP-032-2-D3245-...	M 45 x 1,5	●						32	82	75	124,5	16	39
	 <p>metric male thread with 24° sealing cone to DIN 2353 (light duty series L, heavy duty series S)</p>	LP-032-2-S3852-...	M 52 x 2	●				S	38	32	82	75	130,5	22	39	2280
	 <p>British standard pipe parallel (BSPP) female thread to DIN ISO 228</p>	LP-032-2-WR548-... LP-032-2-WR560-...	BSPP 1 1/2" BSPP 2"	● ●	● ●	● ●	○ ○				82 82	75 75	122,5 126,5	25 29	39 39	2390 2260
		 <p>hose connection</p>	LP-032-2-SL042-...	42 mm	○	○	○	○				82	75	174,5	61	39
Thru type adaptors	 <p>British standard pipe parallel (BSPP) male thread to DIN ISO 228</p>	LP-032-1-WR048-... LP-032-1-WR060-...	BSPP 1 1/2" BSPP 2"	● ○	○ ○	○ ○	○ ○				60 72,5	55 65	74,5 78,5	22 26	39 39	600 650
		 <p>British standard pipe parallel (BSPP) female thread to DIN ISO 228</p>	LP-032-1-WR542-... LP-032-1-WR548-... LP-032-1-WR560-...	BSPP 1 1/4" BSPP 1 1/2" BSPP 2"	● ● ○	○ ○ ●	○ ○ ●	○ ○ ○			60 65 78	55 60 70	71 71 75	25 25 29	39 39 39	610 640 790
	 <p>hose connection</p>	LP-032-1-SL042-..	42 mm	○	○	○	○				54		105	61	39	620

Series LP

optional features:
 SI = with additional axial safety lock
 (outer diameter 116 mm)
 GG = with ring grips (cast aluminium)

materials:
 standard:
 11 = steel, zinc plated
 21 = brass, passivated
 22 = brass, chrome plated
 01 = stainless steel 1.4404/1.4571 or similar

seal qualities:
 1 = NBR
 2 = FKM
 4 = EPDM



special materials:
 13 = steel, chem. nickel plated
 24 = brass, chem. nickel plated
 31 = aluminium anodized silver

Please note the technical data on pages 2 - 7, 32 - 33 and the max. working pressures on page 9

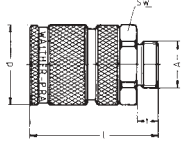
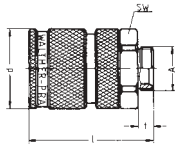
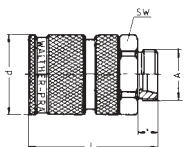
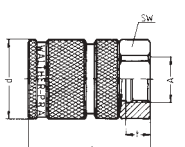
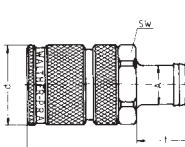
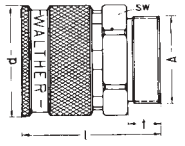
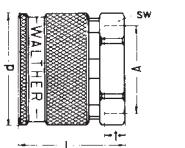
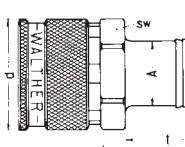
Availability: ● Short ○ Medium ○ Long

	Part No.	Connec- tion A	steel zinc	brass	brass	AISI 316 Ti/	series	pipe OD	n. b.	d	SW	l	t	n	weight [g]
			plated	passivated	chrome plated	1.4571									
Self sealing couplings	 <p>British standard pipe parallel (BSPP) male thread to DIN ISO 228</p>	LP-050-0-WR060-...- LP-050-0-WR075-...-	BSPP 2"	●	○	○				112	100	162	26		5550
				○	○	○									112
	 <p>metric male thread with 60° sealing cone to DIN 7631</p>	LP-050-0-D4965-...-	M 65 x 2						49	112	100	159	18		5440
	 <p>metric male thread with 24° sealing cone to DIN 2353 (light duty series L, heavy duty series S)</p>	LP-050-0-L4252-...-	M 52 x 2		●			L	42	36	112	100	158	16	
 <p>British standard pipe parallel (BSPP) female thread to DIN ISO 228</p>	LP-050-0-WR560-...- LP-050-0-WR575-...-	BSPP 2" BSPP 2 1/2"		●	○	○				112	100	158	29	33	6150
				○	○	○									○
 <p>hose connection</p>	LP-050-0-SL065-...-	65 mm								112	100	209	75		5970
Thru type couplings	 <p>British standard pipe parallel (BSPP) male thread to DIN ISO 228</p>	LP-050-4-WR060-...- LP-050-4-WR075-...-	BSPP 2" BSPP 2 1/2"	○	○	○				112	100	132,5	26	30	3950
				○	○	○									○
	 <p>British standard pipe parallel (BSPP) female thread to DIN ISO 228</p>	LP-050-4-WR560-...- LP-050-4-WR575-...-	BSPP 2" BSPP 2 1/2"		●	○	○				112	100	106,5	27	31
○					○	○	○								
 <p>hose connection</p>	LP-050-4-SL065-...-	65 mm								112	100	181,5	75		4050

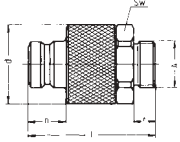
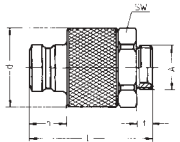
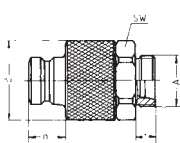
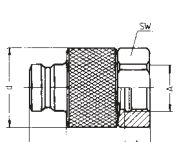
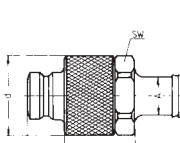
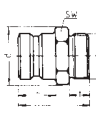
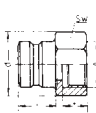
Availability: ● Short ● Medium ○ Long

		Part No.	Connection A	steel zinc plated	brass	passivated brass	chromium plated	AISI 316 Ti/1.4571	series	pipe OD	n. b.	d	SW	l	t	n	weight [g]
Self sealing adaptors		British standard pipe parallel (BSPP) male thread to DIN ISO 228 LP-050-2-WR060-...-. LP-050-2-WR075-...-.	BSPP 2" BSPP 2 1/2"	●	○	○	○	○				112 112	100 100	158 160	26 30	46 46	5010 5020
		metric male thread with 60° sealing cone to DIN 7631 LP-050-2-D4965-...-.	M 65 x 2								49	112	100	155	18	46	4900
		metric male thread with 24° sealing cone to DIN 2353 (light duty series L, heavy duty series S) LP-050-2-L4252-...-.	M 52 x 2	●					L	42	36	112	100	154	16	46	4840
		British standard pipe parallel (BSPP) female thread to DIN ISO 228 LP-050-2-WR560-...-. LP-050-2-WR575-...-.	BSPP 2" BSPP 2 1/2"	●	○	○	○	○				112 112	100 100	154 163	29 33	46 46	5610 5400
		hose connection LP-050-2-SL065-...-.	65 mm									112	100	205	75	46	5430
Thru type adaptors		British standard pipe parallel (BSPP) male thread to DIN ISO 228 LP-050-1-WR060-...-.	BSPP 2"	●	○	○	○					92	85	88	26	46	1590
		British standard pipe parallel (BSPP) female thread to DIN ISO 228 LP-050-1-WR560-...-.	BSPP 2"	●	○	○	○					92	85	82	29	46	1850
		hose connection LP-050-1-SL065-...-.	65 mm		○	○	○	○				90		131	75	46	2050

Measurement of flow coefficients Cv according to DIN EN 60534

Flow speeds of 8 m/sec should not be exceeded

1 bar = 14,5 PSI

Both sides self sealing

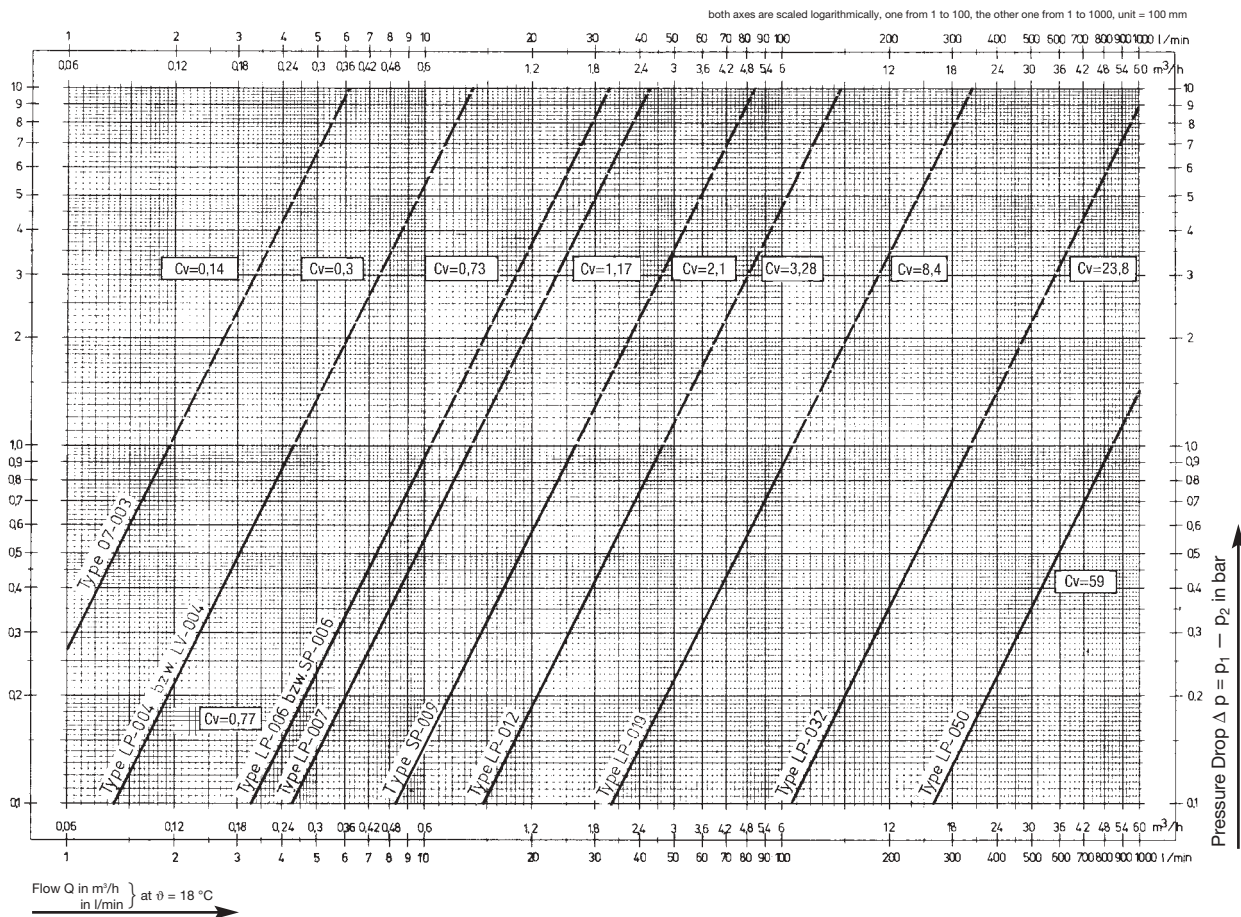

One side self sealing

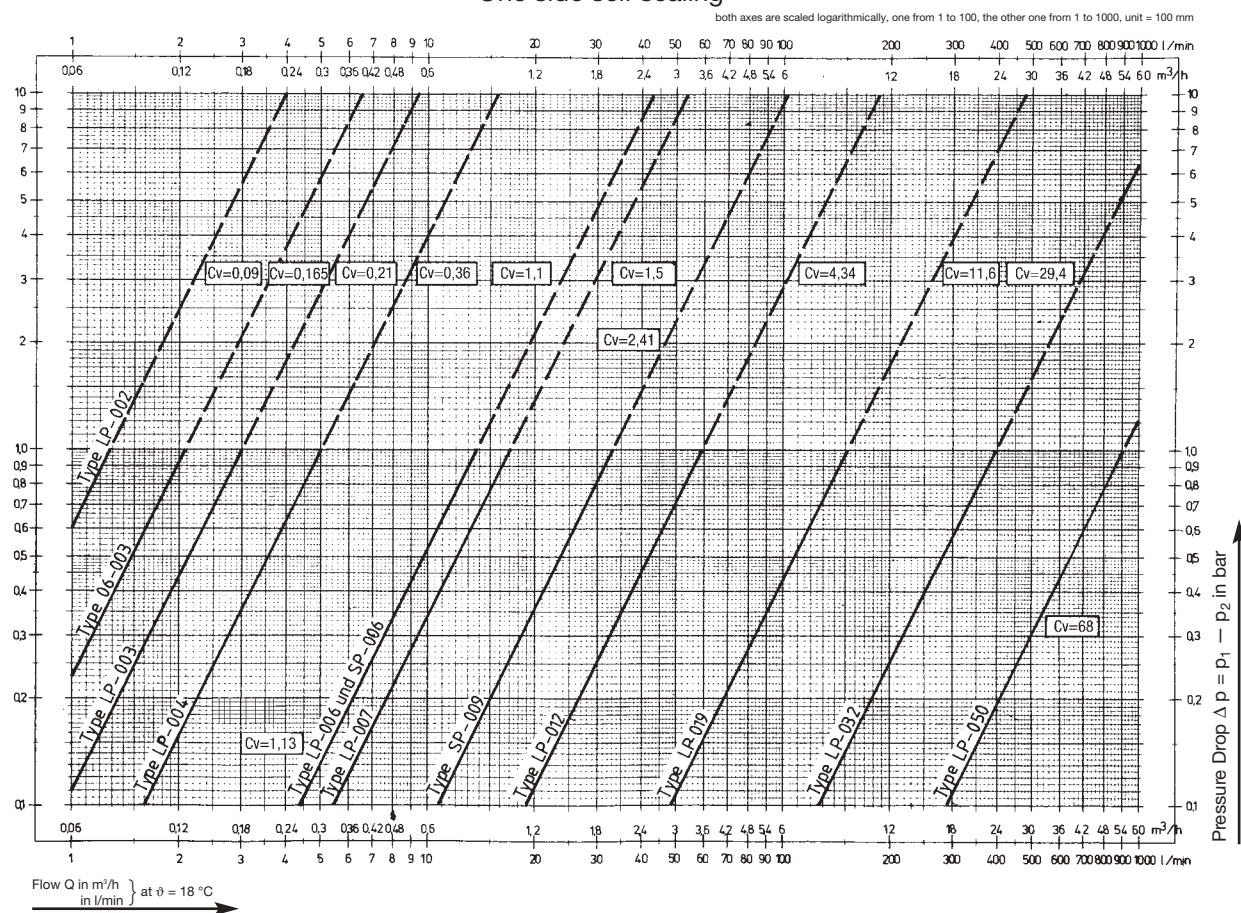

Measurement of flow coefficients C_v according to DIN EN 60534

Working pressure 6 bar gauge pressure

1 bar = 14,5 PSI

Both sides self sealing

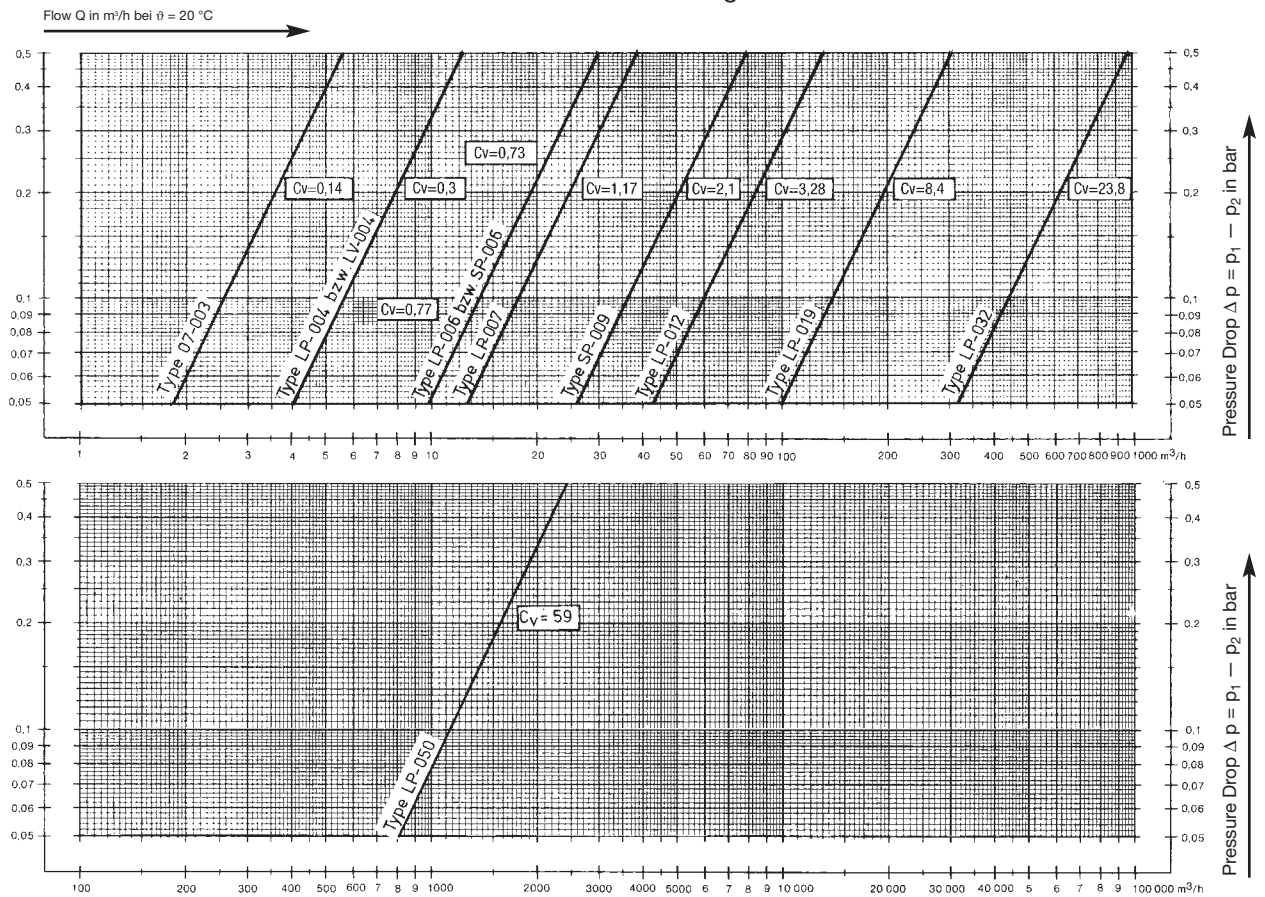

One side self sealing

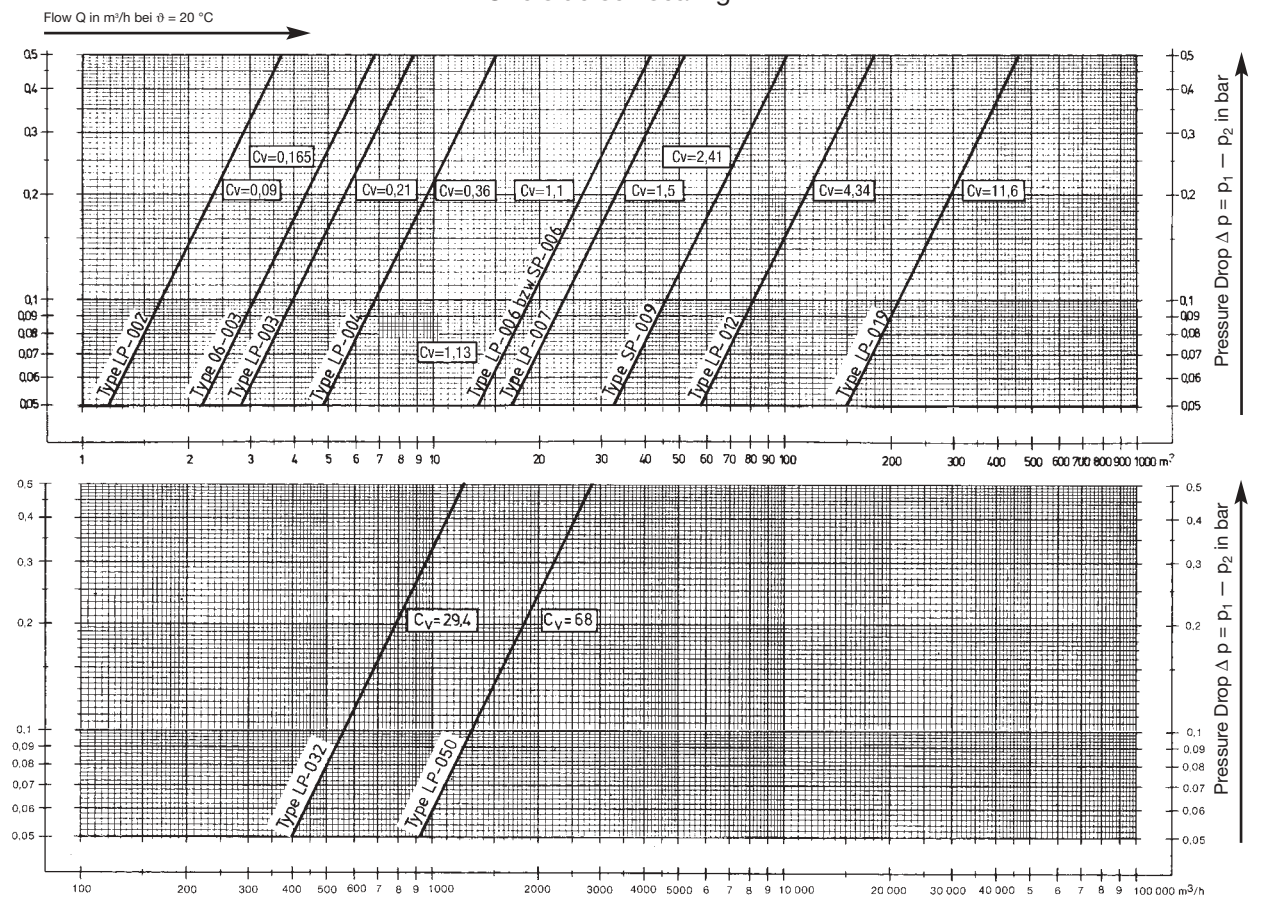

materials:
 standard:
 11 = steel, zinc plated

seal qualities:
 1 = NBR
 2 = FKM
 4 = EPDM

special materials:
 21 = brass, passivated
 01 = stainless steel 1.4404/1.4571 or similar
 50 = polyamide 11/12, grey (PA)

Availability: ● Short ○ Medium ○ Long

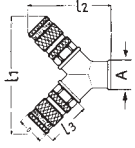
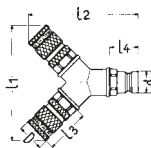
	Part No.	equipped with	steel zinc-plated	D	n.b.	d	d1	l	l1	l2	l3	l4	Weight [g]
 <p>British standard pipe parallel (BSPP) female thread to DIN ISO 228 and 2 self sealing couplings</p>	2R-006-0-WR517-...-	3/8" BSPP, 2 ssc LP-006	○	25	6				116	81	47,5		430
	2R-007-0-WR521-...-	1/2" BSPP, 2 ssc LP-007	○	30	7				140	96	57		710
	2R-012-0-WR533-...-	1" BSPP, 2 ssc LP-012	○	40	12				178	128	65		1440
 <p>1 thru type adaptors and 2 self sealing couplings, type LP-006</p>	2S-006-0-WR517-...-	1 tta, 2ssc, LP-006	○	25	6	12			116	110	47,5	26	430

