



RFM

Router Fleet Manager

USER GUIDE

The Router Fleet Manager RFM product family is manufactured by

ETIC TELECOM
13 Chemin du vieux chêne
38240 MEYLAN
FRANCE

In case of difficulty in implementing the product, you can contact your reseller, or contact our customer support service:

TEL : + (33) (0)4-76-04-20-05
E-mail : hotline@etictelecom.com
web : www.etictelecom.com

DECLARATION OF CONFORMITY

The manufacturer, ETIC Telecom – 13 chemin du vieux chêne – 38240 Meylan – France, Hereby declares under sole responsibility that the listed devices conform to

- the Radio Equipment Directive (RED) 2014/53/UE,
- the Restriction of the use of certain Hazardous Substances (RoHS) Directive 2011/65/UE.

Type of device: Router Fleet Manager

Models: RFM-E-400

Part Number: 1061000

The harmonized standards to which this device complies are:

Standard	Title
EN 61000-6-2 2006	Immunity: EN61000-4-2 Electrostatic Discharge EN61000-4-3 RF Radiated Immunity EN61000-4-4 EFT/Burst Immunity EN61000-4-5 Surge Immunity EN61000-4-6 RF Conducted Immunity EN61000-4-8 Power Frequency Magnetic Field Immunity
EN 61000-6-4 2007 A1/2011	Emission: EN55022 Radiated and conducted emission
EN 301 489-1 V1.9.2 EN 301 489-3 V1.6.1 EN 301 489-7 V1.3.1 EN 301 489-17 V2.2.1 EN 301 489-24 V1.5.1	Radio - EMC
EN 301 511 V9.0.2 EN 301 908-1 V6.2.1 EN 301 908-2 V6.2.1 EN 300 328 V1.9.1 EN 301893 V1.8.1	Radio - Spectrum
EN 60950-1/A2 2014 EN 62311 2008	Safety and Health

Date : 28th February 2021

Philippe Duchesne
Technical Director



PRESENTATION	7
1 Aim of the document	7
2 Product identification	7
3 Specifications.....	8
4 Product presentation	11
4.1 Application	11
4.2 Main features	11
4.3 General operation principles.....	13
INSTALLATION	15
1 Description	15
1.1 Dimensions	15
1.2 Front face.....	15
1.3 Rear view	15
1.4 Connectors.....	16
1.5 Push Button (PB)	16
1.6 Indicators	16
2 Safety instructions	17
3 Ventilation	17
4 Grounding.....	17
PARAMETRAGE	18

PRESENTATION

1 Aim of the document

This document describes the implementation of the Router Fleet Manager RFM.

In the remainder of the document, this product is designated simply by the word “RFM”.

2 Product identification

The commercial name of the Router Fleet Manager is: RFM-E-400 (Part Number to be mentioned in the orders: 1061000).

The main features are summarized below:

	RFM-E-400
WAN Ethernet	•
LAN Ethernet 10-100 Mb/s	4
USB	•
Power VAC	110-230

3 Specifications

Main features	
Dimensions	With feet: 50 X 220 X 220 mm (h, l, p) Without feet: 44 X 220 X 220 mm (h, l, p)
Weight	Max 0.65 kg
Casing	Metallic IP20 – IEC60529
Temperature	Storage: -40° / + 85°C In operation: -20° / + 60°C (without the fan)
Humidity	10 à 95 % (without condensation)
Power	110 to 230 VAC
Consumption	2W
EMC	Immunity EN61000-6-2 : EN61000-4-2 : ESD : 4 kV contact – 8kV air EN61000-4-3 : RF radiated : 10V/m < 2 GHz EN61000-4-4 : Burst EN61000-4-5 : Surge : 4KV line / earth EN61000-4-6 : RF conducted EN61000-4-8 : Magnetic fields Emission EN61000-6-4 : EN 55022 : RF conducted and radiated
Electrical safety	EN 60950-1
Hazardous substances	2011/65/UE (RoHS) REACH

WAN network	
Ethernet	RJ45 Auto : 10/100 full & half duplex MDI/MDI-X

LAN network	
Ethernet	RJ45 : 4 ports Auto : 10/100 full & half duplex MDI/MDI-X

Routing / @IP /	
IP routing	Routing tables Static rules RIP Address translation (DNAT, SNAT, NAT 1:1)
@IP	WAN interface: DHCP client or fixed IP LAN interface: DHCP server
DNS	WAN interface: compatible DYNDNS, No-IP or ETIC DNS LAN interface: DNS relay
Redundancy	VRRP protocol RFC 3768

PRESENTATION

Safety	
VPN tunnel	OpenVPN (TLS/SSL), IPSEC, L2TP/IPSEC, PPTP Shared key or X509 certificate Encryption 3DES & AES 128-192-256 Authentication: MD5 & SHA-1 Up to 100 VPN tunnels (mix between & OpenVPN IPSEC possible)
Firewall	Stateful packet inspection (SPI : 50 rules) Filtering @ IP and ports number
Remote access	Up to 25 users Login, Password and certificate (optional) Access rights to individualized equipment
Log	Time stamped Events: connection, restart, alarms

Miscellaneous	
SNMP	MIBs available : RFC1213-MIB (MIB-2) Traps SNMP
Configuration	Web server
Management	Saving configurations Product reset for return to factory configuration

4 Product presentation

4.1 Application

The RFM-E-400 simplifies the management of your fleet of RAS Machine Access Boxes by automating the update of remote sites maintained and by centralizing in the RFM the management of access rights for each operator.

The RFM-E-400 is an option of the M2Me remote maintenance solution which allows faster and safer management of a fleet of RAS. The RFM mainly targets medium/large fleets of RAS.

NOTE: the interconnection of an RFM on a existing fleet of RAS, presupposes a significant charging time. This load time includes the creation ex nihilo in the RFM of all remote maintainer users as well as the ex nihilo creation in the RFM of all remote sites to be maintained.

The RFM is configured using a PC equipped with a web browser. No additional software is required. For security reasons, access rights will be defined for the RFM.

The RFM is an industrial router on which is installed a management system for a fleet of routers. It therefore has an HTML interface for configuring the network part identical to that of our range of routers as well as a very simple configuration interface dedicated to fleet management.

NOTE: The detailed configuration of the RFM is described in a separate document available on our WEB site or from the hotline service (hotline@etictelecom.com)

4.2 Main features

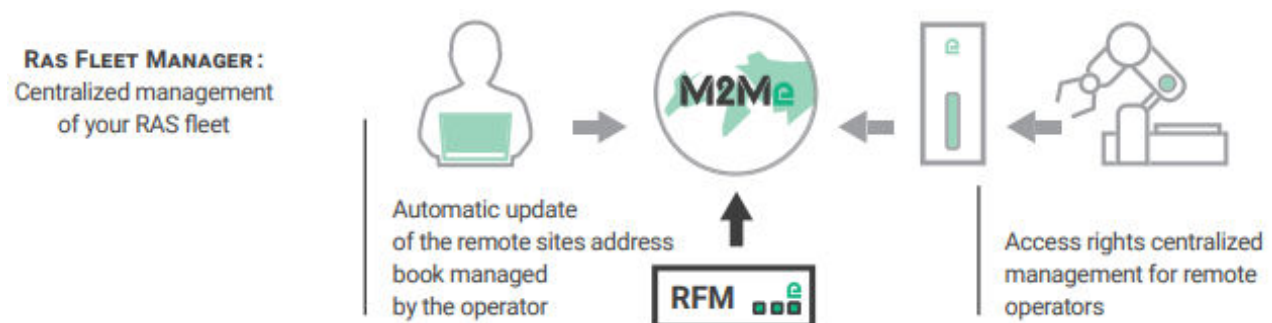

Management of the peering of remote sites to the RFM according to two cases:

- **1st case: The fleet of RAS already exists:**

A remote site database must be created in the RFM. Each site equipped with a RAS is attached to the RFM by entering the RAS Product Key (PK) in the RFM (see RAS user manual) and a user ID of a remote maintainer. (If the RAS is protected, you will also need to enter the administrator's password).

NOTE: in this specific case, it is advisable to call the Etic Telecom hotline service for a quicker start.

- **2nd case: This is a new RAS in the fleet (recommended case).**

This new RAS must be added to the RFM database.

When installing the RAS, you will need to fill in the "administration rights" section as follows:

PRESENTATION

List of administrators

Name	Password
azer	*****

Buttons: Show, Edit, Delete, Add ..., Copy and edit, ^, v, <, >

Configuration interface

The configuration web interface may be protected by a password. The above values will be used if this feature is enabled. The configuration over the WAN will be enabled only if the password is not the default one and the checkbox is checked.

Configuration interface settings:

- Password protect the configuration interface
- Protocols to use for configuration: HTTP and HTTPS
- HTTP port for administration (8080): 8080 (1 to 32000, step 1)
- HTTPS port for administration (4433): 4433 (1 to 32000, step 1)
- Use the factory certificate
- Enable access through M2me (HTTPS only) (highlighted with a red box)
- Enable access from the WAN (HTTPS only)

The configuration of the RFM is then done by:

- Providing the PK (Product key) of the RAS.
- Providing the username and password of an administrator (in this case: azer and xxxxxx)

Add site

Name: Test Site

Group: No group

Product key: 6676B543-9882-4939-8A63-C9680E4BD679

Configuration access: Directly (with https on RAS firmware > 4.4.1)

Administration credentials

Enter here the identifiers of the Machine Access Box in the configuration menu (Home > Setup > Security > Administration rights)

Administrator: username, password

Buttons: Apply, Cancel

User management:

Users (remote sites maintainers) are created in the RFM where their access rights to the various sites are managed.

RFM therefore enables a centralized policy for the management of user passwords, leading to more secure management of the fleet (eg: regular updating of passwords made very simple and automated).

NOTE: RFM administrator does not necessarily know the remote maintainer passwords.

RFM allows a user to be attached to an operating group subject to common rules (same remotely managed sites, same rights on remote sites, etc.).

Distribution of the site address book to the new M2Me Client (An M2Me Client is provided to each new remote site maintainer):

An M2Me Client launching a secure connection to the M2Me server automatically retrieves from the RFM (permanently connected to the M2Me service) its updated list of remote sites as well as the access rights given to it by the RFM administrator.

4.3 General operation principles

RFM is polling on the RAS fleet and provides the connected RASs with the latest update data on remote user access rights.

Thus, the addition of users, the modification of their rights or their deletion is done automatically without intervention on each site of the fleet.

Both the RFM and the M2Me Client installed on the remote user's PC are part of the secure M2Me Telecom solution.

Thus, a remote maintainer using the RFM has the possibility of always having an up-to-date list of remote sites.

INSTALLATION

1 Description

1.1 Dimensions

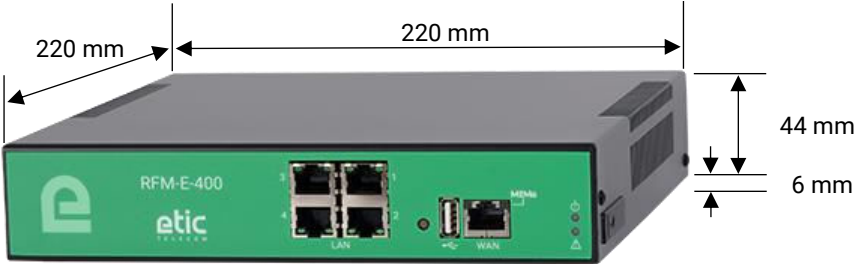

1.2 Front face

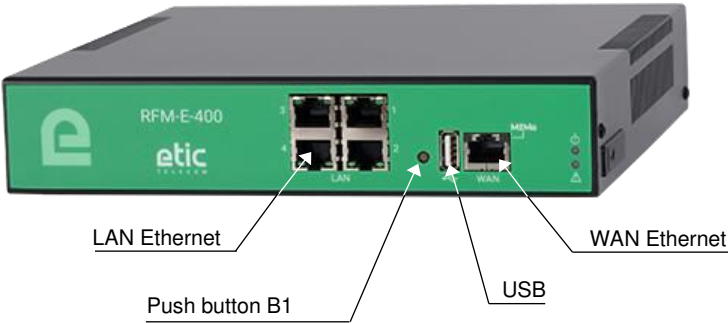

1.3 Rear view

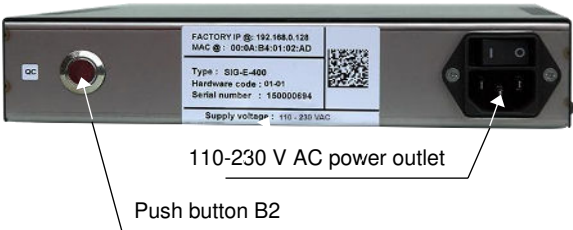

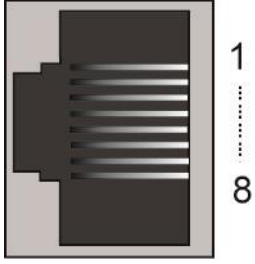

INSTALLATION

1.4 Connectors



Connecteur RJ45 Ethernet			
Pin	Signal	Fonction	RJ45
1	Tx +	Emission polarity +	
2	Tx -	Emission polarity -	
3	Rx +	Reception polarity +	
4	N.C	-	
5	N.C	-	
6	Rx -	Reception polarity -	
7	N.C.	-	
8	N.C.	-	

1.5 Push Button (PB)

Push button of the front face B1		
PB push	Indicator 	Feature
10 secondes	5 pulses	ETIC TELECOM hotline is authorized to establish a remote connection to the RFM within 1 hour.

Rear face push Button B2		
PB push	Indicator 	Feature
During operation	Blinking red	Temporary return to the Factory configuration. (IP address : 192.168.0.128) Current configuration is kept.
Simultaneously with power on	Blinking red	Permanent return to Factory configuration. Current configuration is lost unless it has been saved to a file.

1.6 Indicators

LED According to models		
Features	Indicator	Description
Opération		Off Power Off Steady green In function Slow flashing green Busy Steady Red Start up (30s) - Otherwise serious hardware or software fault or missing SIM card or missing recording media Fast flashing Red Firmware loading in progress
Alarm application		Reserved
M2Me Connection	M2Me	Off Not connected to M2Me_Connect service Slow flashing 2s Connection in process Steady Green Connected
WAN Ethernet	Left light	Off Not connected or interface disabled Green Connected / light flash when data is present
LAN Ethernet x 4	Left light	Off Not connected or interface disabled Green Connected / light flash when data is present

2 Safety instructions

RFM must be installed by a qualified operator, in a cabinet or computer rack providing an enclosure against fire.

RFM must only be connected to equipment that complies with IEC60950-1 or IEC62368-1 standards that meet the following classifications:

- IEC60950-1 : limited power source and interconnection circuit of following type: TBTS – §2.2 et 2.5
- IEC62368-1 : ES1 & PS2



To avoid any risk of burns, it is strongly recommended to wear gloves when handling the product in operation when the ambient temperature exceeds 30 ° C.

3 Ventilation

The product is designed to be installed in a computer cabinet or rack.

To avoid any heating, in particular when the ambient temperature can rise in the cabinet, take care to leave a space of 1 cm on each side and 2.5 cm above and below the product to facilitate the heat flow.

4 Grounding

For reasons of safety and electromagnetic compatibility, the box must be connected to the protective earth of the installation by means of its power cable.

PARAMETRAGE

The configuration of the RFM is described in detail in the following document: **RFM Setup guide**.

In case of difficulty, the hotline team (hotline@etictelecom.com // Tel : +33 (0) 4 76 04 20 00) is at your disposal to get started with the RFM



13, Chemin du Vieux Chêne
38240 Meylan - France

Tel : +33 (0)4 76 04 20 00
contact@etictelecom.com

www.etictelecom.com