



## Construction

Close-coupled self-priming shallow well jet pumps with built-in ejector.

NG: version with pump casing and lantern bracket in cast iron.

B-NG: version with pump casing and lantern bracket in bronze (the pumps are supplied fully painted).

## Applications

For drawing water out of a well.

As pressure boosting pump for central water systems with low pressure (follow local specifications if increasing network pressure).

For clean liquids or slightly dirty surface water.

For garden use.

For washing with a jet of water.

## Operating conditions

Liquid temperature up to 40 °C.

Ambient temperature up to 40 °C.

Maximum permissible working pressure up to 10 bar.

Continuous duty.

## Motor

2-pole induction motor, 50 Hz (n = 2900 rpm).

NG: three-phase 230/400 V ± 10%.

NGM: single-phase 230 V ± 10%, with thermal protector.

Capacitor inside the terminal box.

Insulation class F.

Protection IP 54.

**Classification scheme IE2 for three-phase motors from 0,75 kW.**

Constructed in accordance with: EN 60034-1; EN 60034-30.

EN 60335-1, EN 60335-2-41.

## Special features on request

- Other voltages. - Frequency 60 Hz (as per 60 Hz data sheet).

- Protection IP 55.

- Special mechanical seal

## Materials

Components	NG	B-NG
Pump casing Cover with lantern bracket Diffuser plate	Cast iron GJL 200 EN 1561	Bronze G-Cu Sn 10 EN 1982
Impeller	Brass P- Cu Zn 40 Pb 2 UNI 5705	
Shaft	Cr steel 1.4104 EN 10088 (AISI 430) for NG 3-4 Cr-Ni steel 1.4305 EN 10088 (AISI 303) for NG 5-6-7-32	Cr-Ni-Mo steel 1.4401 EN 10088 AISI 316
Ejector casing NG 32	Cast iron GJL 200 EN 1561	-
Diffuser	PPO-GF20 (Noryl)	
Nozzle	PPO-GF20 (Noryl) (Brass P- Cu Zn 40 Pb 2 UNI 5705 for NG 32)	
Mechanical seal	Carbon - Ceramic - NBR	

## Characteristic Curves for suction lift H<sub>s</sub> = 1 m n ≈ 2900 rpm

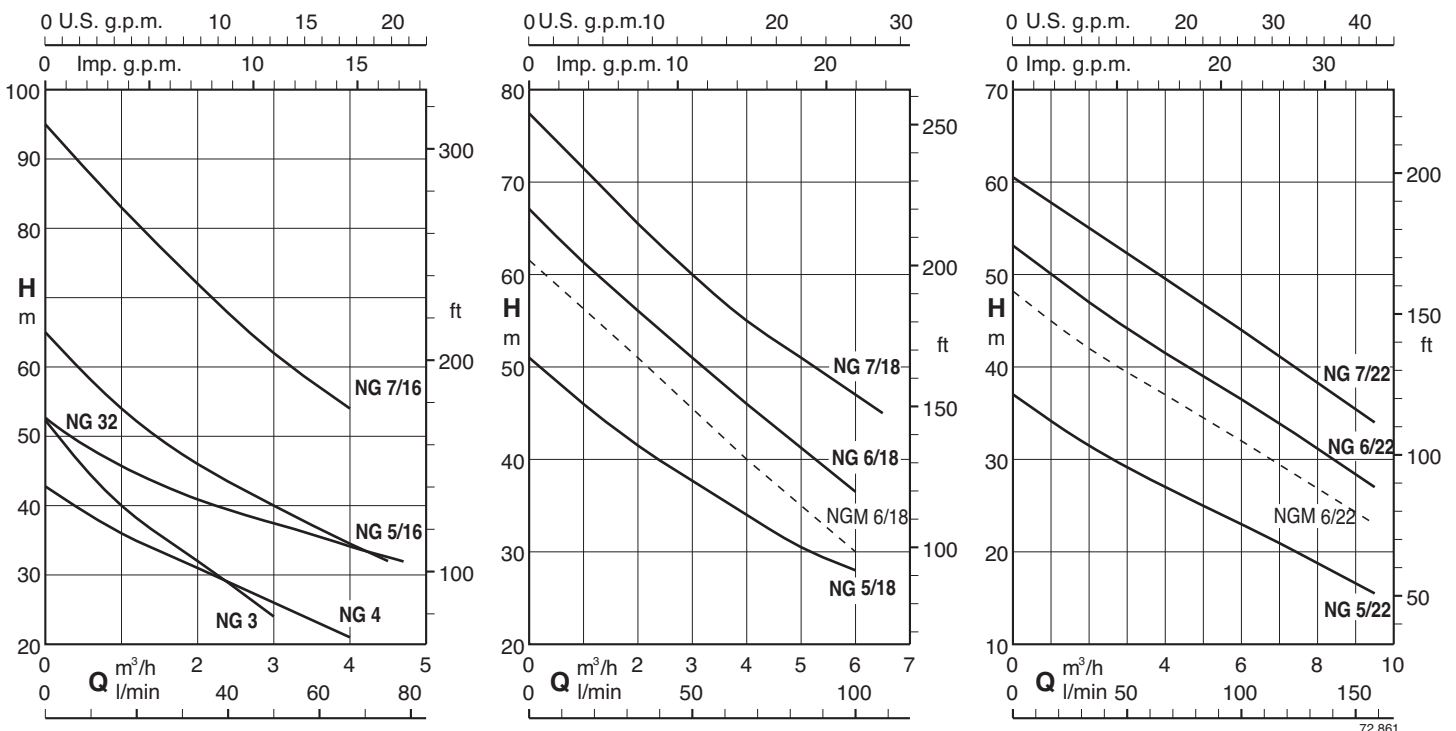

# NG Self-Priming Jet Pumps

**Performance** for suction lift  $H_s = 1\text{ m}$   $n \approx 2900\text{ rpm}$

3 ~	230V 400V		1 ~	230V P <sub>1</sub>		P <sub>2</sub>		Q m <sup>3</sup> /h l/min	H m																
	A	A		A	kW	kW	HP		0,25	0,5	1	1,5	2	2,5	3	3,5	4	4,5	5	5,5	6	6,5	7	8	9
B- NG 3/A	3	1,7	B- NGM 3/A	4,5	0,9	0,55	0,75	49	45,5	40	36	32	28	24											
B- NG 4/A	3,7	2,2	B- NGM 4/A	5,7	1	0,75	1	41	39	36	33	31	29	26	24	21									
NG 32E	4,7	2,7	NGM 32E	7,4	1,47	1,1	1,5	49	46	43,5	41	39	38	36	34	33	31								
B- NG 5/16E	4,7	2,7	B- NGM 5/16E	7,4	1,64	1,1	1,5	59	54	50	46	43	40	37	34,5	32									
B- NG 5/18E	4,7	2,7	B- NGM 5/18E	7,4	1,68	1,1	1,5	48,5	46	43,5	41,5	39,5	38	35,5	34	32	30,5	29	28						
B- NG 5/22E	4,7	2,7	B- NGM 5/22E	7,4	1,55	1,1	1,5	35,5	34,5	33	31,5	30,5	29,5	28	27	26	25	23,5	23	21,5	20,5	18,5	16,5	15,5	
B- NG 6/18E	7,5	4,3				1,5	2	64,5	62	59	56	54	51	48,5	46	43,5	41,5	39	36,5						
			B- NGM 6/18E	9,2	2	1,5	2	59	57	54	51	48	45	43	40	37,5	35	33	30						
B- NG 6/22E	7,5	4,3				1,5	2	51,5	50	48,5	47	46	44,5	43	41,5	40	39	37,5	36,5	35	33,5	31	28,5	27	
			B- NGM 6/22E	9,2	2	1,5	2	47	45	43,5	42	41	40	38	37	36	35	33	32	31	30	27	24	23	
B- NG 7/16/A	9,15	5,3				2,2	3	89	83	77	72	67	62	58	54										
B- NG 7/18/A	9,15	5,3				2,2	3	74,5	71,5	68,5	65,5	63	60	57,5	55	53	51	49	47	45					
B- NG 7/22/A	9,15	5,3				2,2	3	59	57,5	56,5	55	54	52,5	51	50	48,5	47	45,5	44	42,5	41,5	38	35	34	

P<sub>1</sub> Max. power input.

P<sub>2</sub> Rated motor power output.

B-NG, B-NGM = Bronze construction.

Tolerances according to ISO 9906, annex A.

## Installation examples

### Positive suction head operation

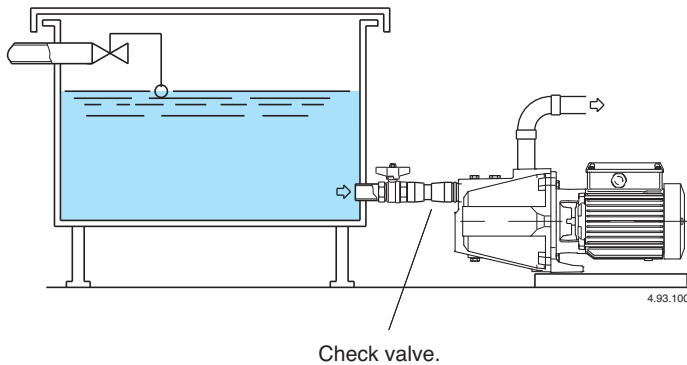

### Suction lift operation

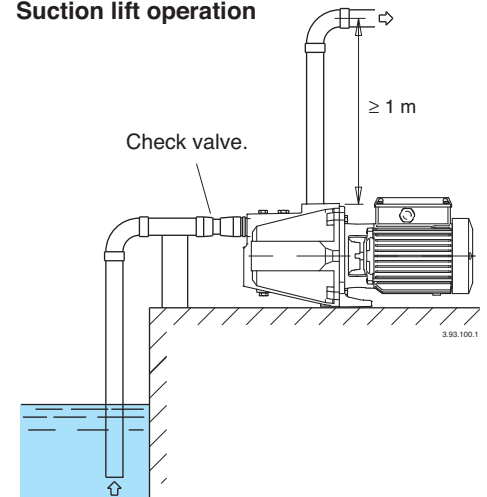

## Dimensions and weights

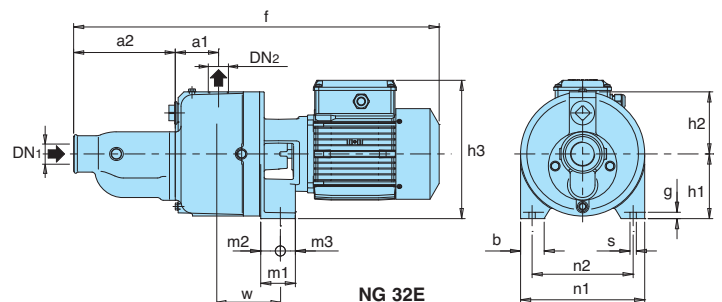
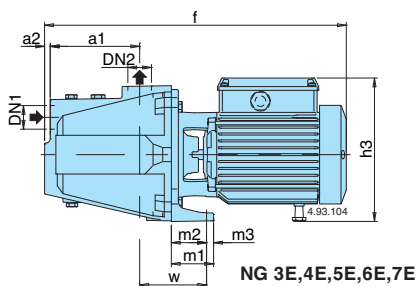

TYPE	DN <sub>1</sub>	DN <sub>2</sub>	mm															kg	
			a1	a2	f	h1	h2	h3	m1	m2	m3	n1	n2	b	s	w	g	NG	B-NG
NG 3/A B-NG 3/A	G 1	G 1	127	8	430	150	43	207	60	52	8	185	155	35	9,5	100	11	18,4	20,8
NG 4/A B-NG 4/A	G 1	G 1	127	8	430	150	43	207	60	52	8	185	155	35	9,5	100	11	19,2	21,5
NG 5E B-NG 5E	G 1 1/2	G 1	160	10	560	165	57	197	60	50	10	215	175	40	11,5	115	11	29,2	31,6
NG 6E B-NG 6E	G 1 1/2	G 1	160	10	560	165	57	197	60	50	10	215	175	40	11,5	115	11	30,8	32,9
NG 7/A B-NG 7/A	G 1 1/2	G 1	160	10	600	165	57	197	60	50	10	215	175	40	11,5	115	11	31,3	33,4
NG 32E	G 1 1/2	G 1	75	175	557	112	108	222	60	34	26	215	175	40	11	106	10	38	-

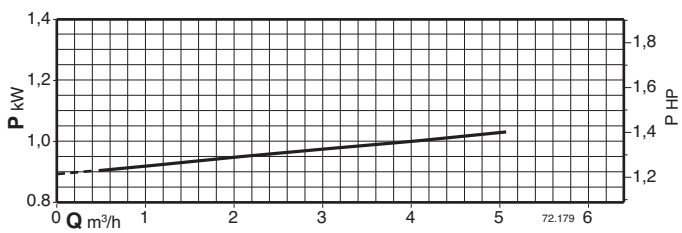
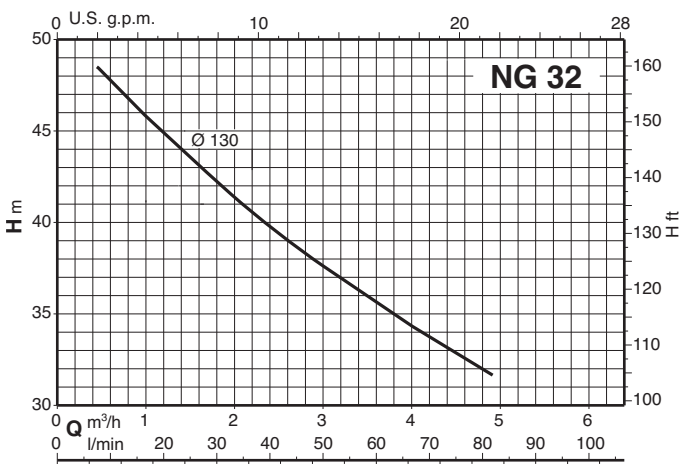
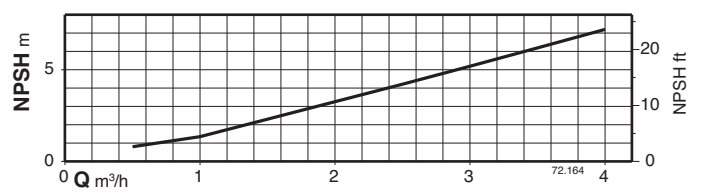
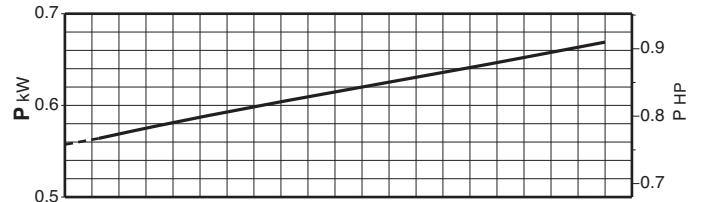
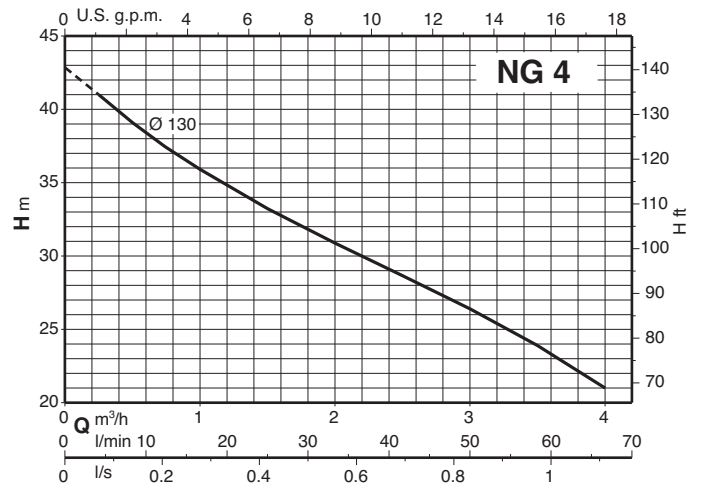
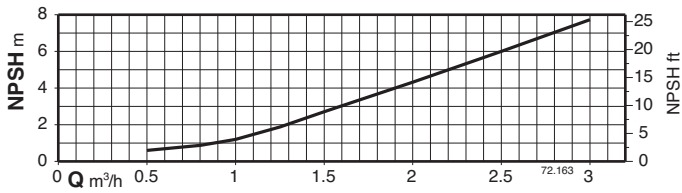
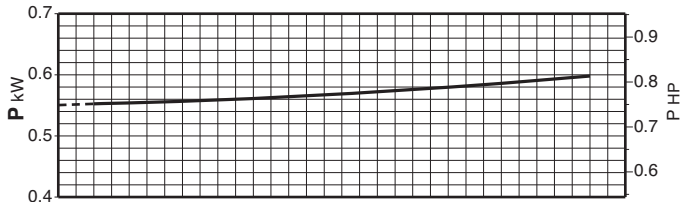
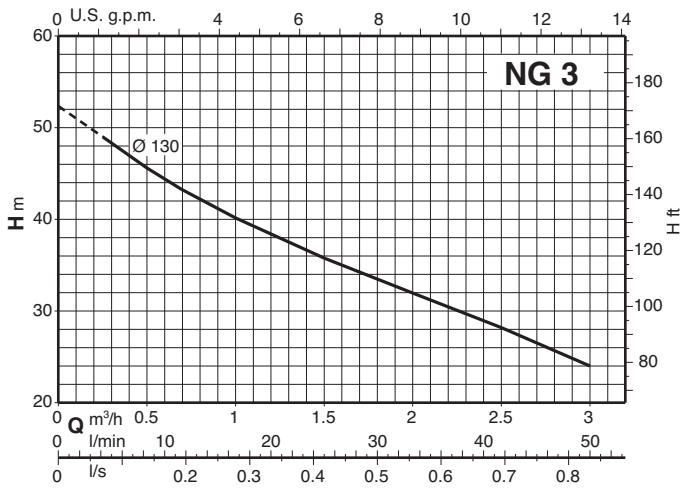
**Characteristic curves  $n \approx 2900$  rpm**

## Characteristic curves $n \approx 2900$ rpm

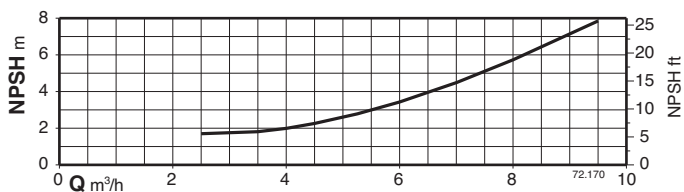
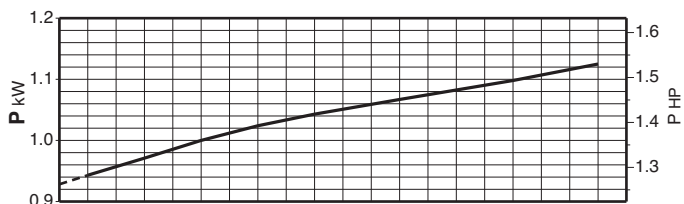
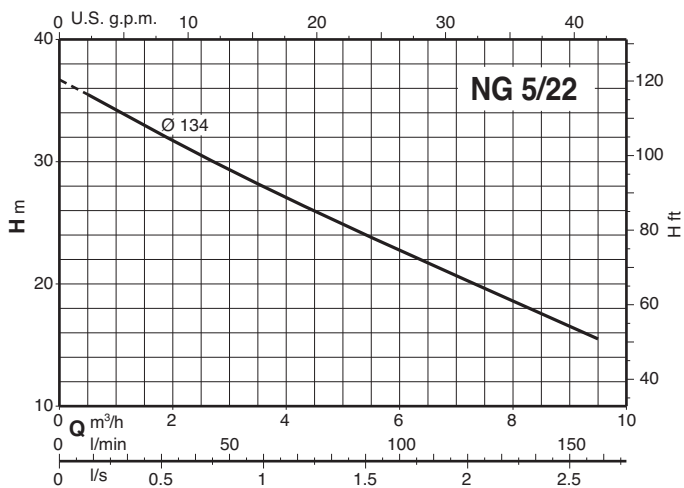
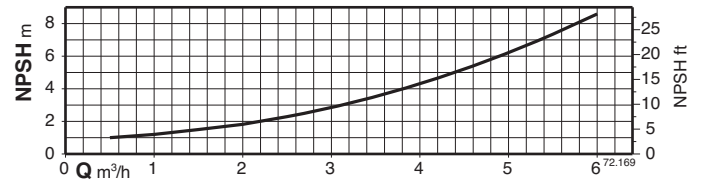
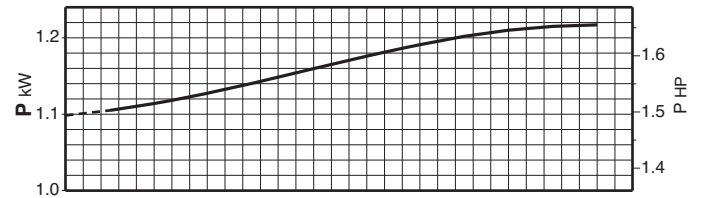
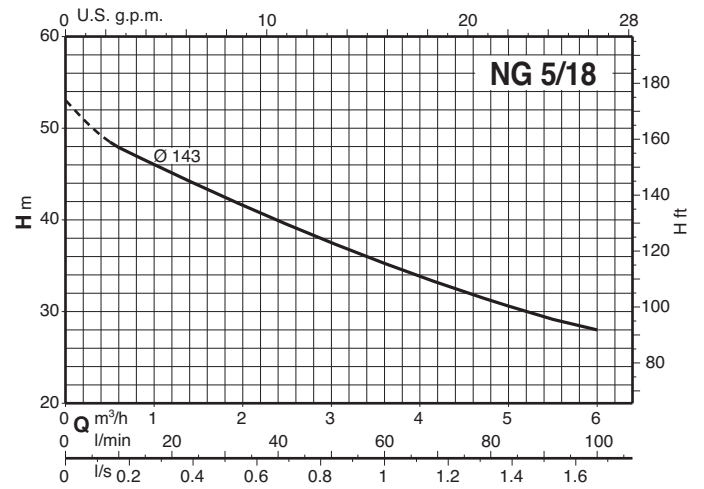
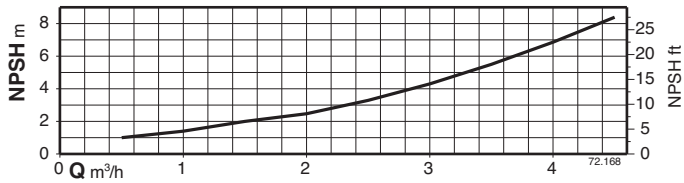
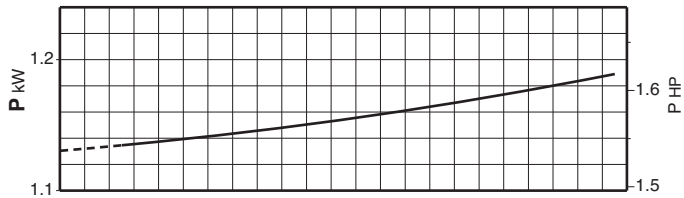
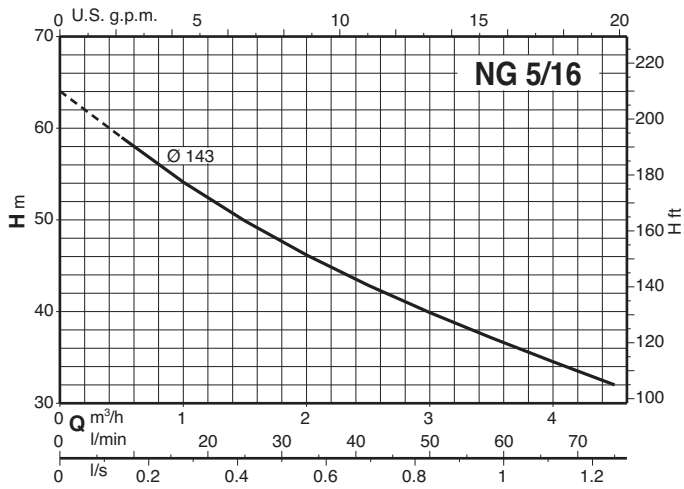

Characteristic curves  $n \approx 2900$  rpm

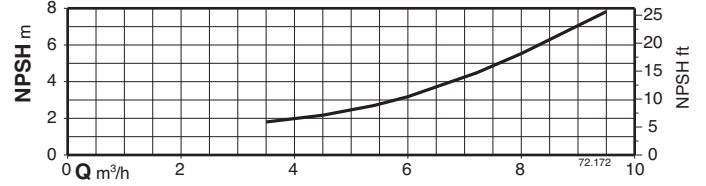
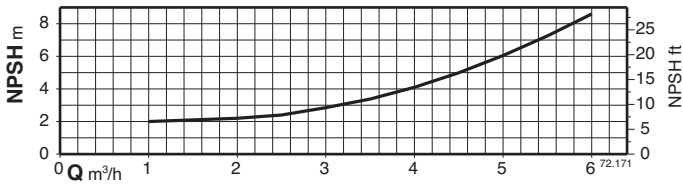
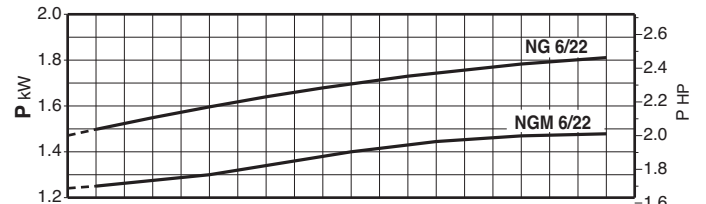
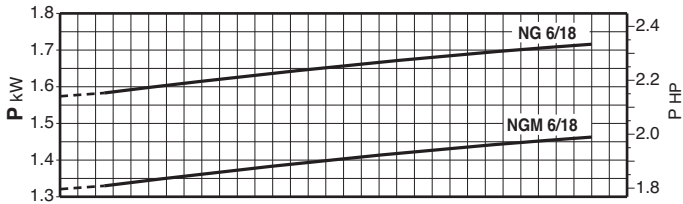
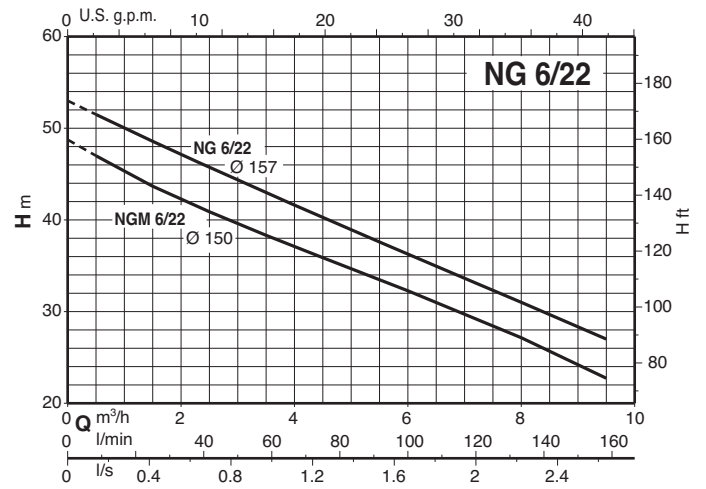
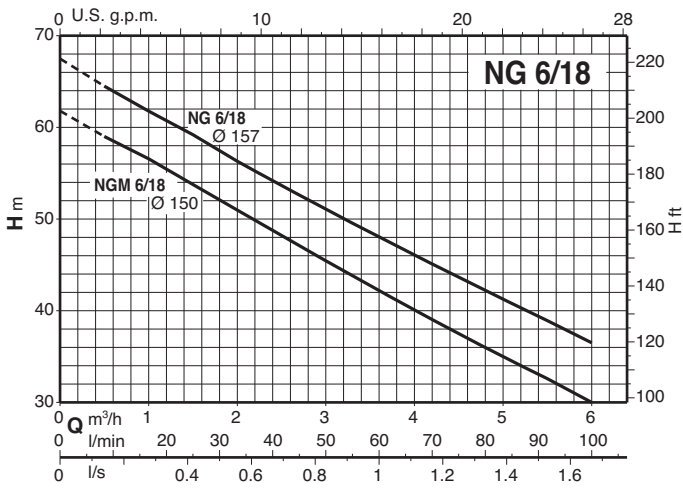

Characteristic curves  $n \approx 2900$  rpm

