

# TZA500 Series



# Transimpedance Amplifier

Read this instruction manual before performing any task!

# Original Operating Instructions

## Table of Contents

<b>1</b>	<b>ABOUT THIS MANUAL</b>	<b>7</b>
1.1	Information about this manual	7
1.2	Explanation of symbols	7
1.3	Copyright	9
1.4	Customer service	9
<b>2</b>	<b>SAFETY</b>	<b>10</b>
2.1	Intended use	10
2.2	Basic dangers	10
2.3	Responsibility of the owner	11
2.4	Personnel requirements	12
2.5	Symbols on the unit	13
2.6	Scope of delivery	14
2.7	Transport inspection	14
2.8	Packaging	14
2.9	Transporting	15
2.10	Storage	16
<b>3</b>	<b>PRODUCT OVERVIEW</b>	<b>17</b>
3.1	Linear or Logarithmic?	17
<b>4</b>	<b>ABSOLUTE MAXIMUM RATINGS</b>	<b>19</b>
<b>5</b>	<b>ORDERING INFORMATION</b>	<b>19</b>
5.1	Available Models	19
<b>6</b>	<b>SPECIFICATIONS</b>	<b>20</b>
6.1	Typical Signal Forms	21
6.2	Case Dimensions	22
6.3	Front Panel	22

---

6.3.1	Input Receptacle	23
6.3.2	Output Receptacle	23
6.3.3	Overload Indicator (red LED)	23
6.3.4	Power Indicator (green LED)	24
6.3.5	Bias Receptacle	24
<b>6.4</b>	<b>Back Panel</b>	<b>25</b>
6.4.1	Hardwire Interface (DB25 Receptacle)	25
6.4.2	USB Receptacle	25
6.4.3	Power Input Receptacle	25
<b>7</b>	<b>PRINCIPLES OF OPERATION</b>	<b>26</b>
<b>7.1</b>	<b>Input Receptacle</b>	<b>27</b>
<b>7.2</b>	<b>Bias Receptacle</b>	<b>28</b>
<b>7.3</b>	<b>Gain</b>	<b>28</b>
<b>7.4</b>	<b>Output Polarity</b>	<b>29</b>
<b>7.5</b>	<b>Bandwidth Reduction</b>	<b>29</b>
<b>7.6</b>	<b>Auto-Zero</b>	<b>29</b>
<b>8</b>	<b>HARDWIRE INTERFACE</b>	<b>31</b>
<b>9</b>	<b>INSTALLATION OF THE SOFTWARE PACKAGE</b>	<b>32</b>
<b>10</b>	<b>USING THE APPLICATION SOFTWARE</b>	<b>32</b>
<b>10.1</b>	<b>The Functions of the Pull Down Menus</b>	<b>32</b>
<b>10.2</b>	<b>The Tool Bar</b>	<b>35</b>
<b>10.3</b>	<b>The Status Bar</b>	<b>37</b>
<b>10.4</b>	<b>Preferences</b>	<b>38</b>
<b>10.5</b>	<b>Data Formats</b>	<b>39</b>
10.5.1	The *TZA Format	39
10.5.2	The *CSV Format	39
<b>10.6</b>	<b>The Graph</b>	<b>40</b>
10.6.1	The Context Menü	41
<b>10.7</b>	<b>The SDK Package</b>	<b>42</b>

---

<b>10.8</b>	<b>Source Code of the Application Programme</b>	<b>42</b>
<b>10.9</b>	<b>Demo Programm in Labview</b>	<b>44</b>
<b>11</b>	<b>COMMUNICATION WITH THE TZA500</b>	<b>45</b>
<b>11.1</b>	<b>Communication Protocol</b>	<b>45</b>
<b>11.2</b>	<b>Command Structure</b>	<b>47</b>
11.2.1	Change Interface	47
11.2.2	Data output	47
11.2.3	Auto-Zero Function	47
11.2.4	Polarity	47
11.2.5	Bandwidth	48
11.2.6	Info	48
11.2.7	Gain	48
<b>12</b>	<b>DAMAGE</b>	<b>49</b>
<b>12.1</b>	<b>Troubleshooting</b>	<b>49</b>
<b>13</b>	<b>DISPOSAL</b>	<b>50</b>
<b>14</b>	<b>TYPE PLATE</b>	<b>50</b>
<b>15</b>	<b>NOTICE</b>	<b>51</b>

**List of Figures**

Figure 1: Case Dimensions; units mm (inches) ..... 22

Figure 2: Front Panel (BNC input, no bias) ..... 22

Figure 3: Front Panel (BR2 input, with bias receptacle)..... 23

Figure 4: Polarity of Input Receptacles for Positive Output in Non-Inverting Mode..... 23

Figure 5: Pinning of the Bias Receptacle ..... 24

Figure 6: Schematic Diagrammes of Single-Ended Inputs with Bias Inputs..... 24

Figure 7: Back Panel ..... 25

Figure 8: Block Diagramme of the TZA500..... 26

Figure 9: Polarity of Input Receptacles for Positive Output in Non-Inverting Mode..... 27

Figure 10: Schematic Diagrammes of Single-Ended and Differential Input Configurations .. 27

Figure 11: Pinning of the Bias Receptacle ..... 28

Figure 12: Schematic Diagrammes of Single-Ended Inputs with Bias Inputs..... 28

Figure 13: The Graphical User Interface (GUI)..... 32

Figure 14: The Tool Bar..... 35

Figure 15: The Status Bar..... 37

**List of Tables**

Table 1: Absolute Maximum Ratings ..... 19

Table 2: Ordering Information ..... 19

Table 3: Available Models ..... 19

Table 4: Specifications of the TZA500 ..... 20

Table 5: Typical Signal Forms ..... 21

Table 6: Pinning of the Hardwire Interface (DB25) ..... 31

Table 7: Gain Setting via the Hardwire Interface (DB25) ..... 31

Table 8: Bandwidth Setting via the Hardwire Interface (DB25) ..... 31

## 1 About this manual

### 1.1 Information about this manual

This manual is valid for units with firmware version FW2.0, that is, with serial number S/N 131 and higher.

This manual enables you to handle the device in a safe and efficient manner. This manual is part of the device and must be kept in its vicinity in order to ensure that it is available to the personnel at all times.

The personnel must have carefully read and understood this manual before commencing any work. The compliance with all safety information and instructions provided in this manual is essential for safe operation.

Furthermore, all local work protection and general safety regulations applicable at the device's place of installation must be observed.

The illustrations used throughout this manual are intended to provide a general understanding and may deviate from the actual model of the machine.

### 1.2 Explanation of symbols

#### Safety instructions

Safety instructions are marked with symbols in these instructions. The safety instructions are always introduced by signal words which express the extent of the danger.



#### **DANGER!**

This combination of symbol and signal word indicates an immediately-dangerous situation which could cause death or severe injuries if not avoided.



#### **WARNING!**

This combination of symbol and signal word indicates a possibly-dangerous situation which could cause death or severe injuries if it is not avoided.



**CAUTION!**

This combination of symbol and signal word indicates a possibly-dangerous situation which could cause slight injuries if it is not avoided.



**NOTICE!**

This combination of symbol and signal word indicates a possibly-dangerous situation which could cause property and environmental damage if it is not avoided.



Tips and recommendations

*This symbol highlights useful tips and recommendations as well as information designed to ensure efficient and smooth operation.*

**Special safety instructions**

The following symbols are used in the safety instructions to draw attention to specific dangers:



**DANGER!**

This combination of symbol and signal word indicates an immediately-dangerous situation due to electric shock. If an instruction so marked is not heeded, severe or even fatal injuries can be the consequence.



**DANGER!**

This combination of symbol and signal word indicates an immediately-dangerous situation due to laseremission. If an instruction so marked is not heeded, severe or even fatal injuries can be the consequence.



### **1.3 Copyright**

The contents of these instructions are copyrighted. Their use is permitted in the context of using the device. Any use extending beyond this is not allowed without written permission from the manufacturer.

## 2 Safety

This section provides an overview of all safety aspects that are essential to the best possible protection of the personnel and the safe and trouble-free operation of the machine. Additional safety instructions for specific work tasks are contained in the sections regarding the individual life stages of the machine.

### 2.1 Intended use

The transimpedance amplifier TZA500 is designed exclusively as a measurement device for measuring small electrical currents.

The intended use also includes adherence to all specifications in this manual.

Any use exceeding or differing from the intended use applies as misuse.

### 2.2 Basic dangers

The following section describes remaining risks which can arise from the device even with proper use.

In order to reduce risks of personal injury and property damage and avoid dangerous situations, the safety instructions listed here and the safety instructions in the other sections of these instructions must be followed.

#### Electrical current



#### **DANGER!**

#### **Life-threatening danger from electrical current!**

When touching live parts in the external power supply there is an immediate, life-threatening danger from electric shock. Damage to the housing as well as the cable can be life-threatening!

- Work on the external power supply may only be performed by the manufacturer.
- In the event of damage to the housing or the cable, immediately disconnect the voltage supply by pulling out the mains plug and initiate the repair process.

## 2.3 Responsibility of the owner

Owner:

The owner is any such person who operates the transimpedance amplifier for commercial or economic purpose either itself or transfers it to a third party for use and bears the legal responsibility for the safety of the user, the personnel or third parties during the operation.

Owner's duties:

The transimpedance amplifier is used in commercial applications. Therefore, the owner of the respective transimpedance amplifier is subject to the statutory duties of work safety.

In addition to the safety instructions in this manual, the safety, work safety and environmental safety regulations applicable for the area in which the electronic ballast is used must be adhered to. In the process, the following applies in particular:

- The owner must remain updated on the applicable work safety regulations and determine, in the scope of a risk assessment, additional dangers which can arise due to the special working conditions at the place in which the electronic ballast is used. This must be implemented in the form of working instructions for the operation of the transimpedance amplifier.
- During the entire period of use of the transimpedance amplifier, the owner must check whether the working instructions meet the current status of the rules and regulations and to adapt them as necessary.
- The owner must clearly regulate and define responsibilities for the operation, fault rectification and cleaning.
- The owner must make sure that all persons who work with the transimpedance amplifier have read and understood this manual. Moreover, the owner must train the personnel in regular intervals and inform them of the dangers.
- The owner must adhere to all statutory provisions in regard to the regular testing of electrical equipment and document this testing.
- 

In addition, the owner is responsible for ensuring that the unit is always in a technically faultless condition.

## 2.4 Personnel requirements

Qualifications:

The various tasks described in this manual place different requirements on the qualification of the persons to whom these tasks are entrusted.



### **NOTICE!**

**Insufficiently qualified personnel can cause property damage!**

Insufficiently qualified personnel cannot assess the risks when working with the unit.

- All work may only be performed by personnel who are qualified for this purpose.
- Keep insufficiently qualified personnel away from the work area.

Only persons who can be expected to reliably perform this work are permitted to carry out any work with this equipment. Persons whose ability to react is impaired by drugs, alcohol, medications, etc. are not permitted to work with this equipment.

In this manual the following qualifications listed for the personnel for the various tasks are specified:

User:

The user uses and operates the device for its intended purpose without other prior knowledge.

## 2.5 Symbols on the unit

The following symbols and instruction signs are affixed in the work area. These symbols and instruction signs refer to the immediate vicinity in which they are affixed.

### WARNING!

#### Danger due to illegible signage!



- Over time, stickers and signs can get dirty or in some other manner become illegible, so that dangers cannot be recognized and necessary operating instructions cannot be followed. Thus an injury hazard occurs.
- Keep all safety, warning, and operating instructions that are affixed to the device in legible condition.
- Replace damaged signs or stickers immediately.

#### Observe the operating manual



Do not use the indicated appliance until the operating manual has been read.

#### Do not dispose of with the household waste

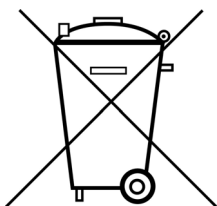

Notice that the transimpedance amplifier may not be disposed of with the household waste. The worn out unit can be taken to an electronics and metal recycling service for disposal. The manufacturer also accepts old units for disposal.

## 2.6 Scope of delivery

Depending of the chosen model, the scope of delivery will vary:

- TZA500 transimpedance amplifier
- Power supply
- USB cable
- USB-Stick with Software, drivers and manual
- Bias shorting adapter plug (models with bias receptacle only)
- Spare connectors (models with BR2 input receptacle only)

## 2.7 Transport inspection

On receipt, immediately inspect the delivery for completeness and transport damage.

Proceed as follows in the event of externally apparent transport damage:

- Do not accept the delivery, or only accept it subject to reservation.
- Note the extent of the damage on the transport documentation or the shipper's delivery note.
- Initiate complaint procedures.



*Issue a complaint in respect of each defect immediately following detection. Damage compensation claims can only be asserted within the applicable complaint deadlines.*

## 2.8 Packaging

### About the packaging

The individual transimpedance amplifier is packaged according to the expected transport conditions. Only environmentally friendly materials were used for the packaging.

The packaging should protect the individual transimpedance amplifier from transport damage, corrosion and other types of damage. Therefore, do not destroy the packaging and save it for later transport and for storage.

## Handling packaging materials

If the transimpedance amplifier no longer has to be transported, dispose of the packaging materials in accordance with the respective statutory provisions and local regulations.



### **NOTICE!**

#### **Danger for the environment from improper disposal!**

Packaging materials are valuable raw materials and can be reused in many cases or prepared and recycled. Dangers for the environment can arise through improper disposal of packaging material.

- Only dispose of packaging materials once it has been determined that the electronic ballast will no longer be transported.
- Dispose of packaging materials in an environmentally friendly manner.
- Observe the locally applicable disposal regulations. If necessary, commission a specialist company with the disposal.

## 2.9 Transporting



### **NOTICE!**

#### **Property damage from improper transport!**

Improper transport can damage the transimpedance amplifier.

- Always transport the transimpedance amplifier in the packaging provided for this purpose.
- Always proceed with caution with the transport of the transimpedance amplifier in the packaging.
- Do not throw the transimpedance amplifier.
- Protect the transimpedance amplifier from vibrations and moisture.
- Do not let the transimpedance amplifier fall.

## 2.10 Storage

Store the electronic ballasts in the packaging under the following conditions:

- Do not store outdoors.
- Store in a dry and dust-free area.
- Do not expose to any aggressive media.
- Protect from sun radiation.
- Avoid mechanical vibrations.
- Storage temperature: 15 to 35 °C.
- Relative air humidity: max. 60 %.



*Under certain circumstances there are instructions for the storage on the packaging, which exceed the requirements specified here. Follow these accordingly.*



## 3 Product Overview

The TZA500 series of amplifiers employs precision dual transimpedance input stages to provide for high common mode rejection and linearity throughout the full dynamic range. The TZA500 may be configured with a differential or single-ended input stage. The differential design requires a floating current input. If the application involves a grounded or biased current source, a single ended amplifier must be used.

These transimpedance amplifiers are particularly useful for the measurement of current from photodiodes. The output is a voltage linearly proportional to input current and thus, to input power in photodiode monitoring applications. The fast response time at high signal-noise-ratio makes this TZA series particularly useful in systems control feedback loops. The high sensitivity and large dynamic range allow measurement of a wide range of optical sources such as lasers and LEDs via a variety of photodiodes for these applications such as Si and InGaAs.

The TZA500 series is insensitive to electromagnetic interference by design, an important factor when working in „dirty“ industrial environments. The proprietary auto-zeroing function allows up to 10V of offset zeroing. This is particularly useful for offsetting dark current or for eliminating a DC signal component to concentrate on signal changes, such as in component burn-in and life-time testing.

The TZA500 may be controlled via the USB port using the graphical user interface software provided with the instrument. Alternatively, the amplifier may be controlled via the DB25 hardwire interface or through direct commands via the USB interface.

The software development kit comprising the GUI source code as well as a LabVIEW<sup>®</sup> demo VI allows for easy integration of the TZA500 into a custom software environment.

### 3.1 Linear or Logarithmic?

The question often arises as to which signal processing technique is better for a system feedback amplifier: an output linearly or logarithmically proportional to the input current.

The use of logarithmic amplifiers for optical power monitoring results from the large dynamic range of relevant powers. For example, the TZA500 series can measure from 10mA to 30pA: more than 8 decades of current (or optical power when measuring photodiodes). This dynamic range is far beyond the capabilities of a linear amplifier in a single gain range.

However, by breaking the measurement into range subgroups, linear amplifiers can easily cover the same dynamic range as a logarithmic amplifier. This method is slightly more complicated than using a logarithmic amplifier with a single gain, but it brings several advantages:

---

<sup>®</sup> LabVIEW is a registered trade mark of the National Instruments Corporation

1. Linear amplifiers are **more stable** than logarithmic amplifiers
2. Linear amplifiers are **faster** than logarithmic amplifiers and **settle more quickly** following sudden input changes
3. Linear amplifiers are **more accurate** than logarithmic amplifiers at higher outputs

Consider an application example: a fibre optic power monitor is used to measure the power coupled into a device in an automated confectioning system. The device being confectioned may be a laser being pigtailed or fibre being connected to an AWG, for example.

Now the automated positioning system takes the measured value of the coupled power (measured by the power monitor) and uses this value to control the motion stages positioning the fibre. The system searches for the position giving the maximum coupled optical power. Obviously, the accuracy of the positioning will depend on the accuracy of the measurement at the **highest** powers measured. Since the logarithm function compresses data, the position dependance of a logarithmic amplifier is flatter than for the linear amplifier at higher power. Thus, the linear amplifier will allow the system to achieve better results in this application. This point is depicted in the following diagram:

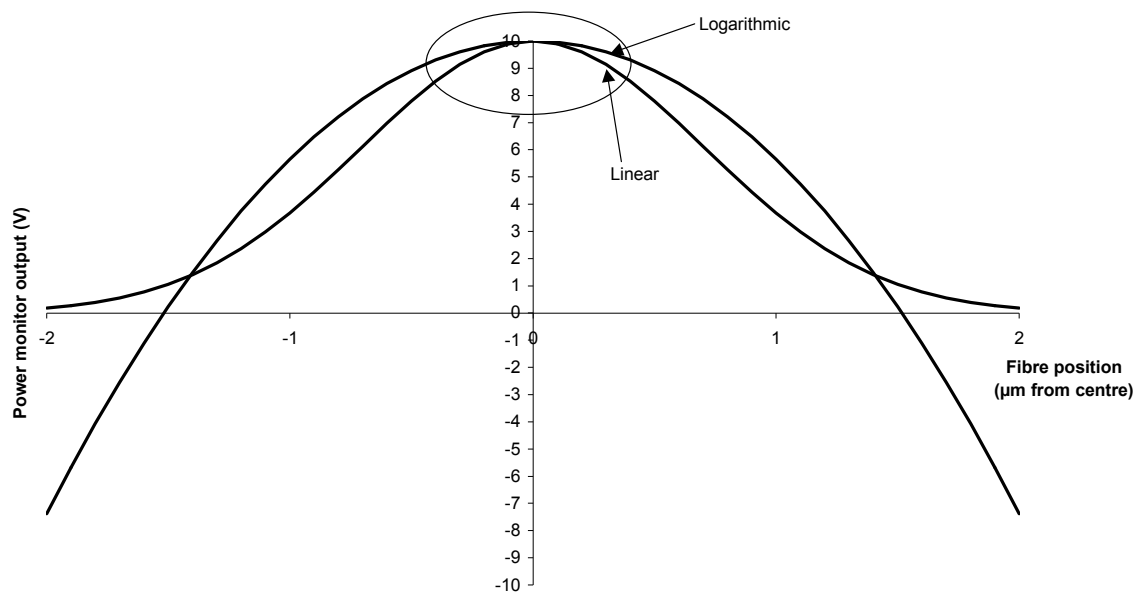

Comparison of linear and logarithmic outputs in a fibre positioning application.  
The linear output results in a sharper peak allowing more accurate positioning.

## 4 Absolute Maximum Ratings

Table 1: Absolute Maximum Ratings

Average Input Current	15mA
Input Voltage	±15V
Bias Voltage	±15V
Temperature Range	0 – 60 °C

## 5 Ordering Information

Table 2: Ordering Information

Full order code:      TZA500      i      r      b

	Options	Description
Input	D	Differential
	S	Single Ended
Receptacle	B	BNC
	T	BR2
Bias		Without bias
	bias	With bias

### 5.1 Available Models

Table 3: Available Models

Model Number	Order Code	Description
TZA500DB	30.100.00021	Differential input; BNC input receptacle, no bias
TZA500DT	30.100.00024	Differential input; BR2 input receptacle, no bias
TZA500SB	30.100.00014	Single-ended input; BNC input receptacle, no bias
TZA500SBbias	30.100.00023	Single-ended input; BNC input receptacle, with bias
TZA500ST	30.100.00025	Single-ended input; BR2 input receptacle, no bias
TZA500STbias	30.100.00016	Single-ended input; BR2 input receptacle, with bias

For example, a TZA500 with single-ended input (for grounded photodiode measurement) would be ordered as:

TZA500SB

For customized systems (eg: customized gain or receptacles), please contact us.

## 6 Specifications

Table 4: Specifications of the TZA500

Parameter	Conditions	Min	Typ	Max	Units
<b>Input</b>					
Current ranges (full scale)	Range: 10 <sup>3</sup> V/A 10 <sup>4</sup> V/A 10 <sup>5</sup> V/A 10 <sup>6</sup> V/A 10 <sup>7</sup> V/A 10 <sup>8</sup> V/A		10 1 100 10 1 100		mA “ μA “ “ nA
Noise equivalent current (NEI <sub>RMS</sub> )	Range: 10 <sup>3</sup> V/A 10 <sup>4</sup> V/A 10 <sup>5</sup> V/A 10 <sup>6</sup> V/A 10 <sup>7</sup> V/A 10 <sup>8</sup> V/A		75 15 1 150 15 10		nA “ “ pA “ “
Impedance		0 (virtual short circuit)			Ω
Connectors		BNC or BR2 <sup>1</sup>			
<b>Output</b>					
Function		Linear analogue $V_{out} = \text{scale} \times I_{in}$			
Output scale	Range: 10 <sup>3</sup> V/A 10 <sup>4</sup> V/A 10 <sup>5</sup> V/A 10 <sup>6</sup> V/A 10 <sup>7</sup> V/A 10 <sup>8</sup> V/A		1 10 0.1 1 10 0.1		V / mA “ V / μA “ “ V / nA
Connectors		BNC and DB25 <sup>1</sup>			
Output range (full scale)				10	V
Rise / Fall time (10% - 90%)				35	μs
Settling time (1%)	Source capacitance: 70pF 2nF		60 80	75 150	μs
Accuracy		± 1			%
Linearity			± 0.1	± 0.2	dB
Output impedance				50	Ω
<b>Logic</b>					
Current required for switching (5V)		-10	0.01	10	μA
Switching time	Source capacitance: 70pF 2nF			75 <sup>2</sup> 150 <sup>2</sup>	μs
<b>Power Supply</b>					
Type		Wall plug (supplied)			
Dimensions		30 x 50 x 60			mm
<b>Dimensions</b>					
		105 <sup>3</sup> x 45 x 116 mm (w x h x l)			mm

<sup>1</sup> Adapters for other connector systems available upon request

<sup>2</sup> Logic switching < 1μs. Effective switching time limited by settling time.

<sup>3</sup> 130 mm including case wings

## 6.1 Typical Signal Forms

Table 5: Typical Signal Forms

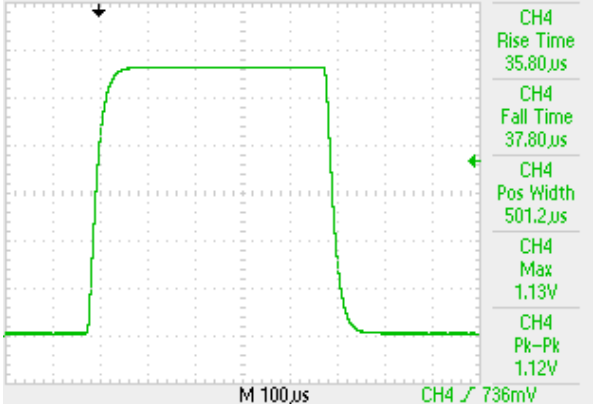
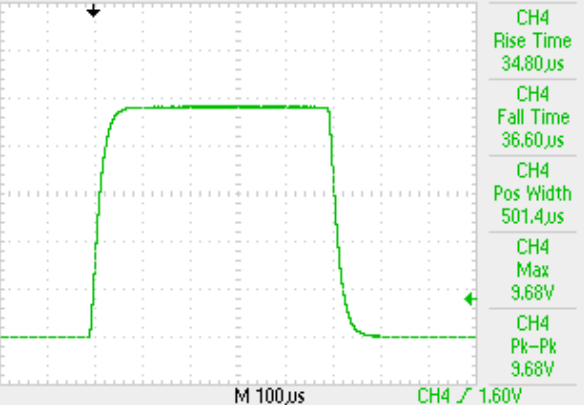
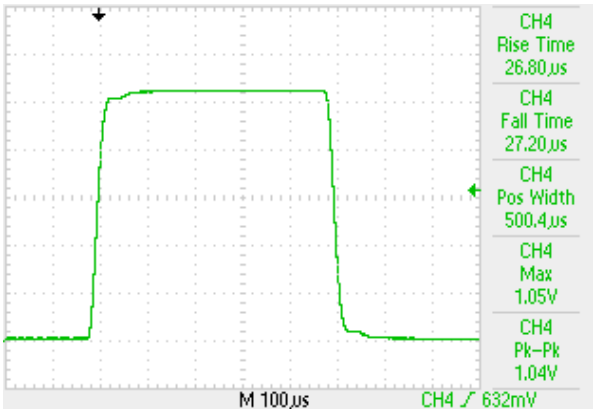
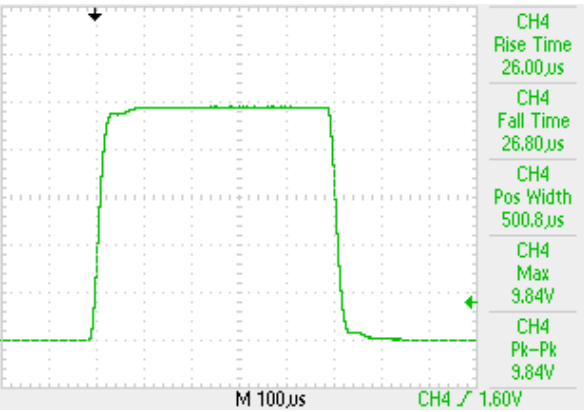
<p>TZA500SBbias: small signal from 70pF source (single ended, BNC input, with bias receptacle)</p>  <p>M 100µs CH4 / 736mV</p> <ul style="list-style-type: none"> <li>CH4 Rise Time 35.80µs</li> <li>CH4 Fall Time 37.80µs</li> <li>CH4 Pos Width 501.2µs</li> <li>CH4 Max 1.13V</li> <li>CH4 Pk-Pk 1.12V</li> </ul>	<p>TZA500SBbias: large signal from 70pF source (single ended, BNC input, with bias receptacle)</p>  <p>M 100µs CH4 / 1.60V</p> <ul style="list-style-type: none"> <li>CH4 Rise Time 34.80µs</li> <li>CH4 Fall Time 36.60µs</li> <li>CH4 Pos Width 501.4µs</li> <li>CH4 Max 9.68V</li> <li>CH4 Pk-Pk 9.68V</li> </ul>
<p>TZA500SBbias: small signal from 2nF source (single ended, BNC input, with bias receptacle)</p>  <p>M 100µs CH4 / 632mV</p> <ul style="list-style-type: none"> <li>CH4 Rise Time 26.80µs</li> <li>CH4 Fall Time 27.20µs</li> <li>CH4 Pos Width 500.4µs</li> <li>CH4 Max 1.05V</li> <li>CH4 Pk-Pk 1.04V</li> </ul>	<p>TZA500SBbias: large signal from 2nF source (single ended, BNC input, with bias receptacle)</p>  <p>M 100µs CH4 / 1.60V</p> <ul style="list-style-type: none"> <li>CH4 Rise Time 26.00µs</li> <li>CH4 Fall Time 26.80µs</li> <li>CH4 Pos Width 500.8µs</li> <li>CH4 Max 9.84V</li> <li>CH4 Pk-Pk 9.84V</li> </ul>

### 6.2 Case Dimensions

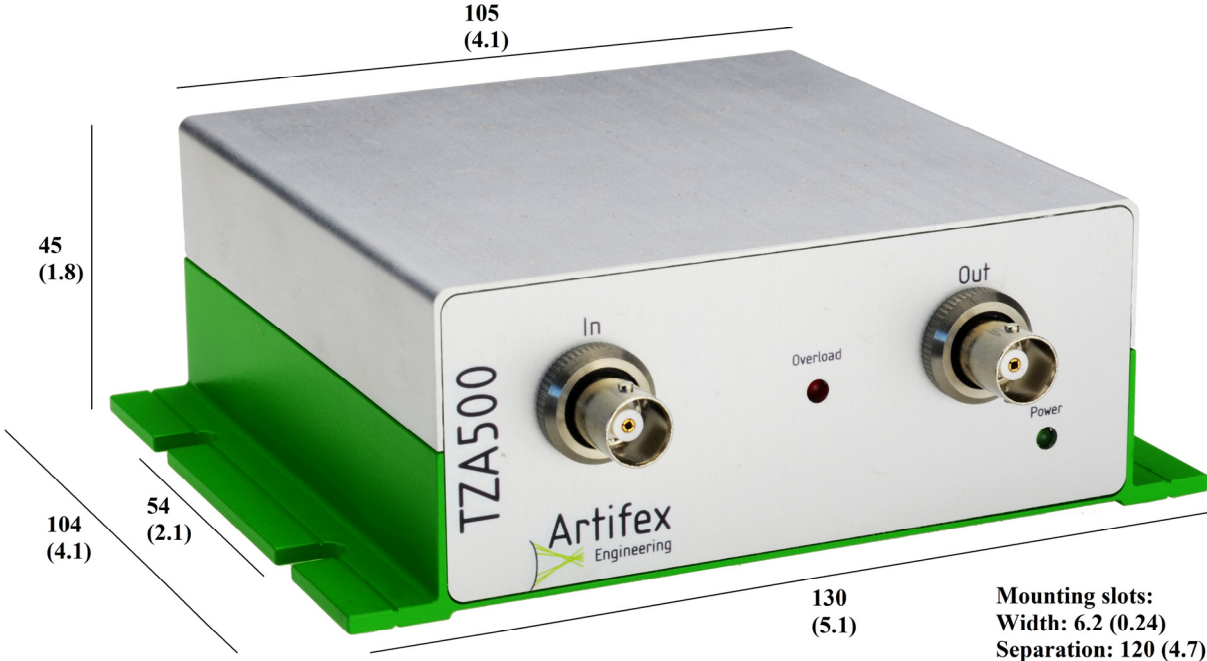

Figure 1: Case Dimensions; units mm (inches)

### 6.3 Front Panel

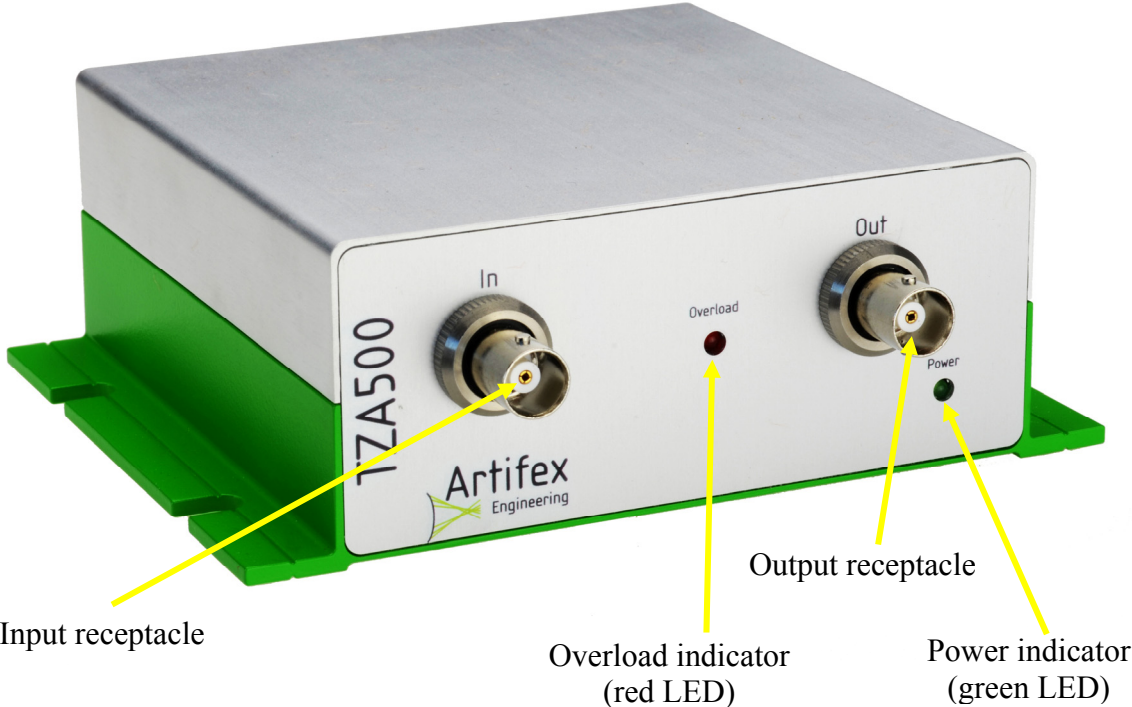

Figure 2: Front Panel (BNC input, no bias)

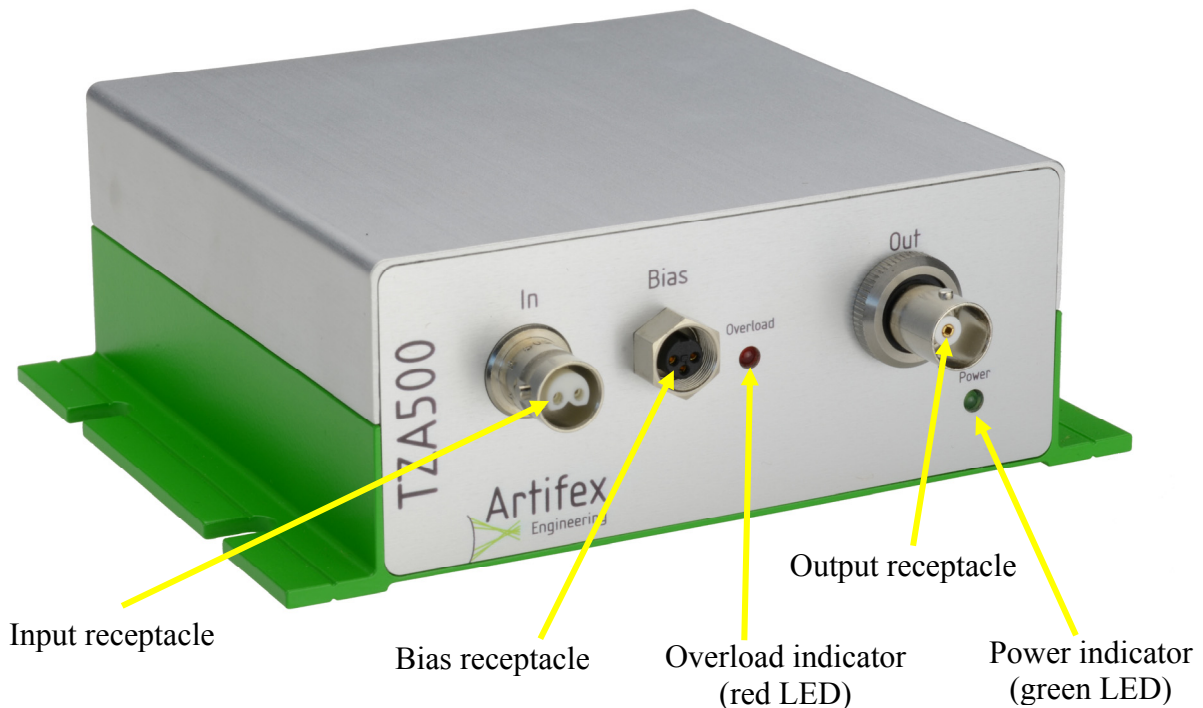

Figure 3: Front Panel (BR2 input, with bias receptacle)

### 6.3.1 Input Receptacle

This receptacle is used to input current for measurement. The receptacle may be BNC or BR2. With the amplifier in non-inverting mode, the output will be positive when a current source is connected to the inner pin of the BNC receptacle or the left input of the BR2 receptacle.

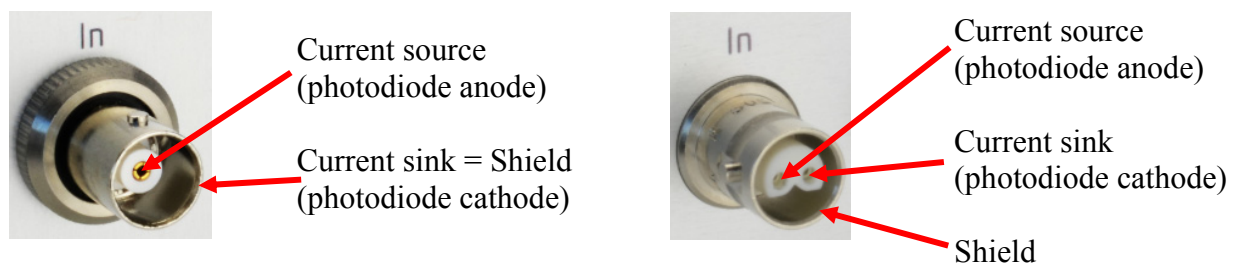

Figure 4: Polarity of Input Receptacles for Positive Output in Non-Inverting Mode

### 6.3.2 Output Receptacle

This BNC receptacle is used to monitor the measurement result with an external instrument such as a DVM, oscilloscope or an A/D converter.

### 6.3.3 Overload Indicator (red LED)

The overload indicator is lit if the input current is too high for the gain range chosen. The overload indicator works only for positive signals and indicates an output greater than 10V. If the overload LED is lit, reduce the input power or reduce the gain setting.

### 6.3.4 Power Indicator (green LED)

The power indicator is lit if the unit is powered on. There is no ON/OFF switch on the TZA500. The unit is powered on when the power supply is connected to the instrument and to the mains. Please be sure to use only the power supply delivered with the unit.

### 6.3.5 Bias Receptacle

TZA500 models with a bias receptacle allow application of an external bias voltage to the device under test. This can be important to ensure full charge depletion in some photoactive devices resulting in more accurate readings when sampling at high speed. The shorting plug adapter must be inserted if an amplifier with bias receptacle is used without an external bias source connected.

Note that the amplifier ground is connected to the amplifier enclosure via the shield contact of the output receptacle. It is therefore recommended to use a potentially floating voltage source for application of a bias voltage.

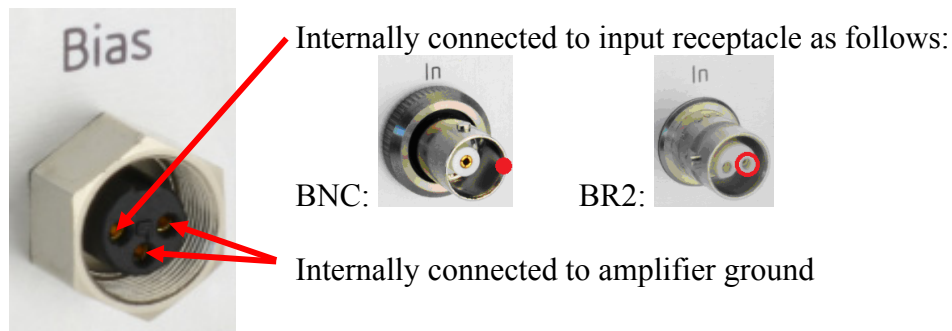

Figure 5: Pinning of the Bias Receptacle

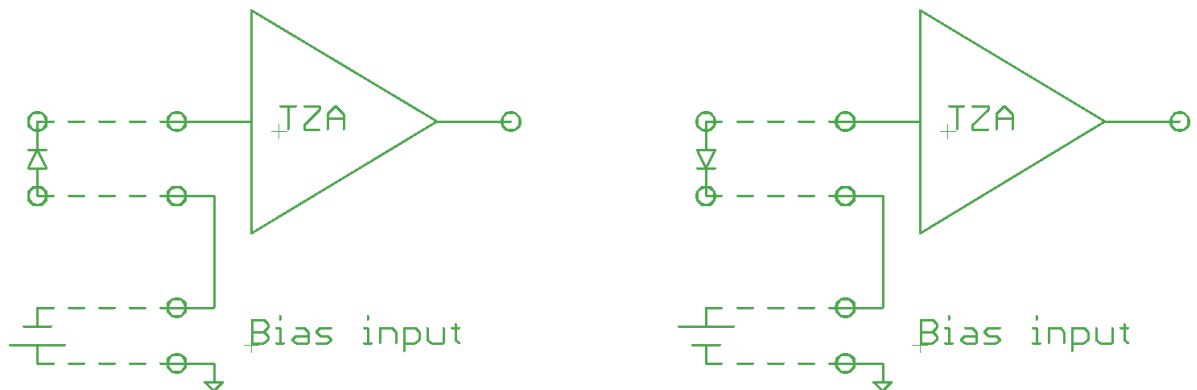

Figure 6: Schematic Diagrammes of Single-Ended Inputs with Bias Inputs



## 6.4 Back Panel

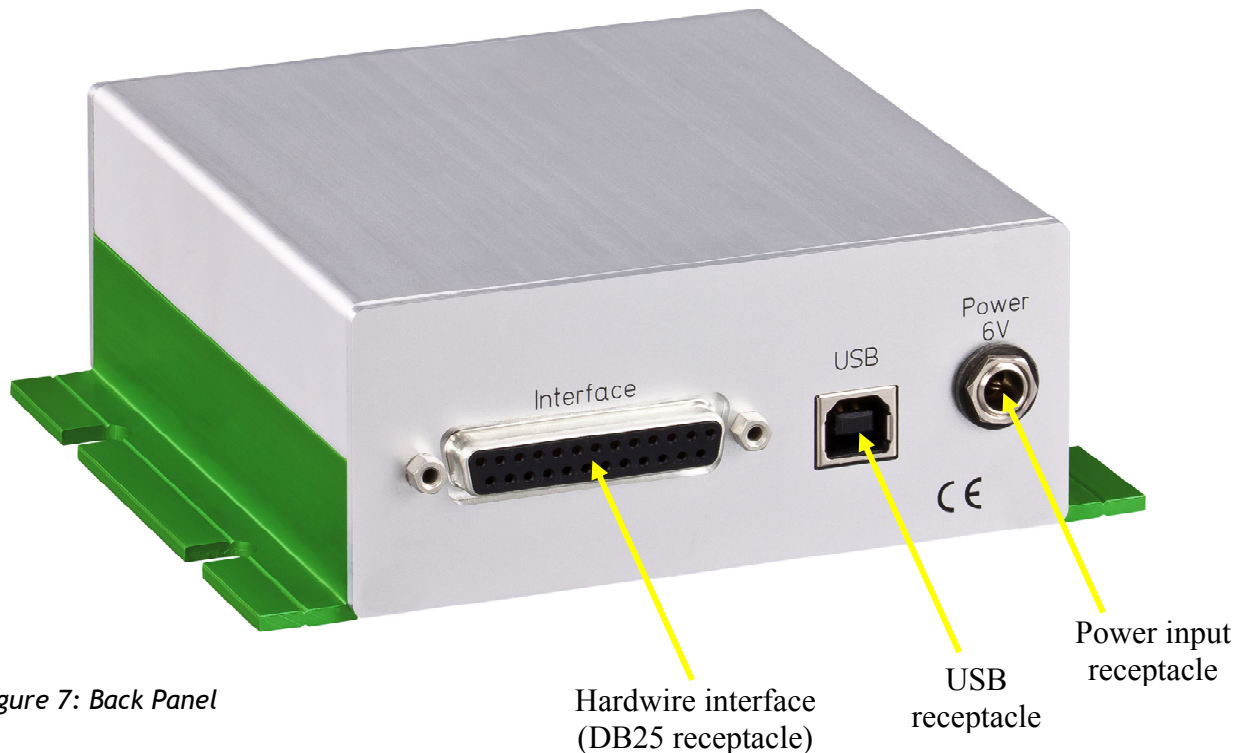

Figure 7: Back Panel

### 6.4.1 Hardwire Interface (DB25 Receptacle)

The hardwire interface is provided for direct, high speed control of the TZA500 via an external switching device such as an A/D-interface card. This interface is described in detail under “8 Hardwire Interface”, pg. 26.

### 6.4.2 USB Receptacle

Communication with the TZA500 may be performed via USB 2.0 with a baud rate of 115 200 bit/s. A hardware-handshake using RTS/CTS is employed to ensure secure communication. The system is fitted with a standard USB A-type receptacle. The appropriate USB cable is supplied with the system.

### 6.4.3 Power Input Receptacle

The power supply input is via this receptacle. The barrel plug of the power supply must be inserted fully into the receptacle and then secured with the knurled nut on the plug. Use only the power supply provided with the TZA500 unit.

## 7 Principles of Operation

The TZA500 measures small currents e.g. optical power via a photodiode. Photodiodes are useful for power measurement in the visible and near infra-red due to their inherent sensitivity and speed of measurement. Photodiodes produce a current which is proportional to the incident light power over a wide dynamic range.

The source current is converted to a voltage through a precise transimpedance amplifier (= current to voltage amplifier). The analogue output signal is available at the BNC connector on the front panel and on the appropriate line on the interface port on the back panel.

This amplifier is very linear over the full measurement range of the device. The TZA500 has 6 gain ranges. The switch is a semiconductor device, free from degradation.

The measured photocurrent may also be read out from the USB port. The voltage generated is converted internally to a digital value via a 12 bit A/D converter. This process and all calculations and communication with the PC are controlled by a microcontroller. The measurement process is started via a command over the USB interface (software trigger). Alternatively, a continuous measurement stream can be started which samples at 1.5 kS/s.

A unique feature of the TZA500 is the auto-zero function. This function is described in detail under “7.6 Auto-Zero”, pg. 29. Further functions include signal inversion and bandwidth reduction.

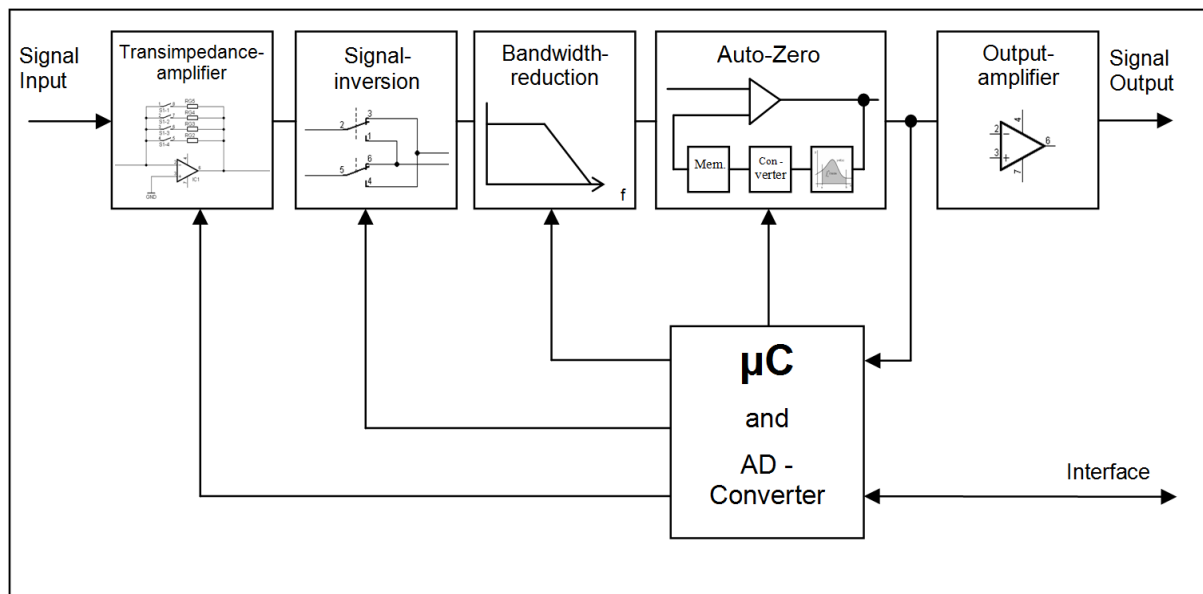

Figure 8: Block Diagramme of the TZA500

## 7.1 Input Receptacle

This receptacle is used to input current for measurement. The receptacle may be BNC or BR2. With the amplifier in non-inverting mode, the output will be positive when a current source is connected to the inner pin of the BNC receptacle or the left input of the BR2 receptacle.

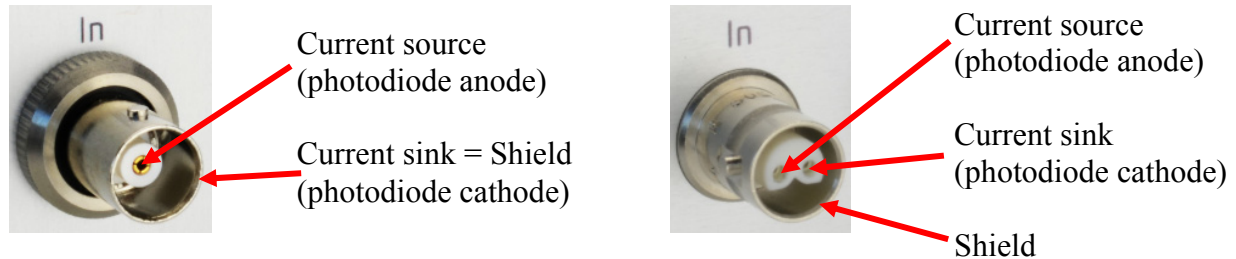

Figure 9: Polarity of Input Receptacles for Positive Output in Non-Inverting Mode

The choice of input receptacle depends on the connector and the input configuration required. The BNC receptacle is a widely used and popular standard. However, this receptacle requires that one of the signal paths lie on the braided shielding of the cable. For highest noise rejection, a cable with a shielded, twisted pair of signal lines is useful. This type of cable requires a BR2 receptacle.

Furthermore, the TZA500 can be ordered optionally with a single-ended or a differential input. In the single-ended configuration, one of the signal paths (source or sink) is grounded internally. In the differential configuration, both signal paths (source and sink) are floating and enter separate transimpedance amplifier stages. The difference of the two pre-outputs is generated which doubles the signal but subtracts any common mode noise. This results in an improved signal-to-noise ratio in electrically “noisy” environments. This topic is discussed in more detail in our application note “Comparison of Noise Levels of TZA500 in BNC and BR2 Versions” which may be downloaded from our web site.

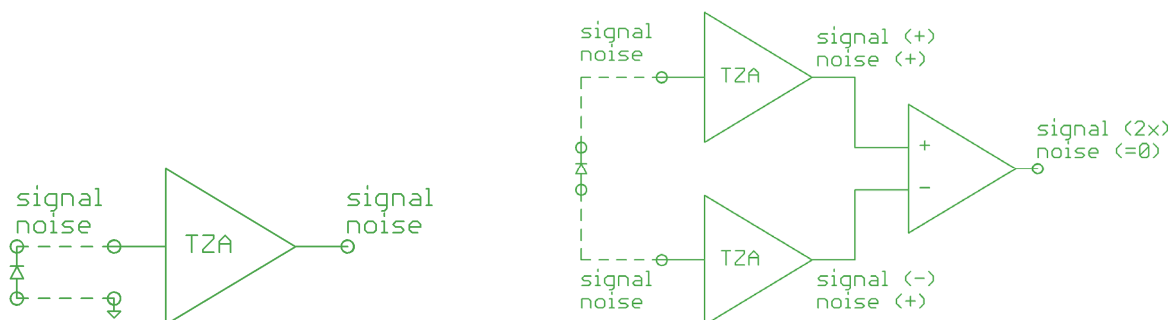

Figure 10: Schematic Diagrammes of Single-Ended and Differential Input Configurations

Note that the differential input configuration is not compatible with source biasing. If the source is grounded or must be biased, the single-ended input configuration must be used.

## 7.2 Bias Receptacle

TZA500 models with a bias receptacle allow application of an external bias voltage to the device under test. This can be important to ensure full charge depletion in some photoactive devices resulting in more accurate readings when sampling at high speed. The shorting plug adapter must be inserted if an amplifier with bias receptacle is used without an external bias source connected.

Note that the amplifier ground is connected to the amplifier enclosure via the shield contact of the output receptacle. It is therefore recommended to use a potentially floating voltage source for application of a bias voltage.

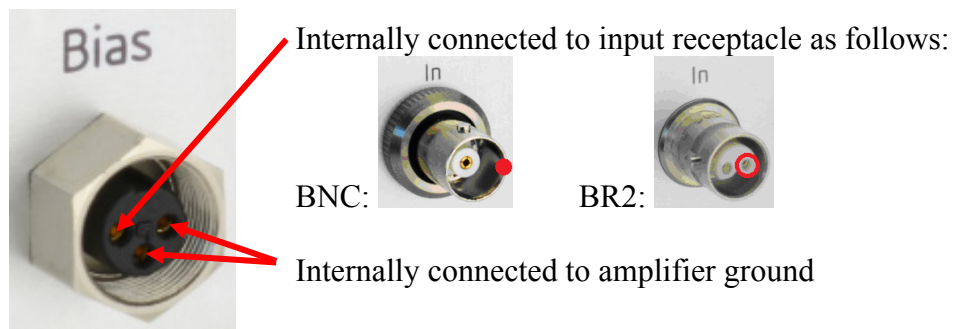

Figure 11: Pinning of the Bias Receptacle

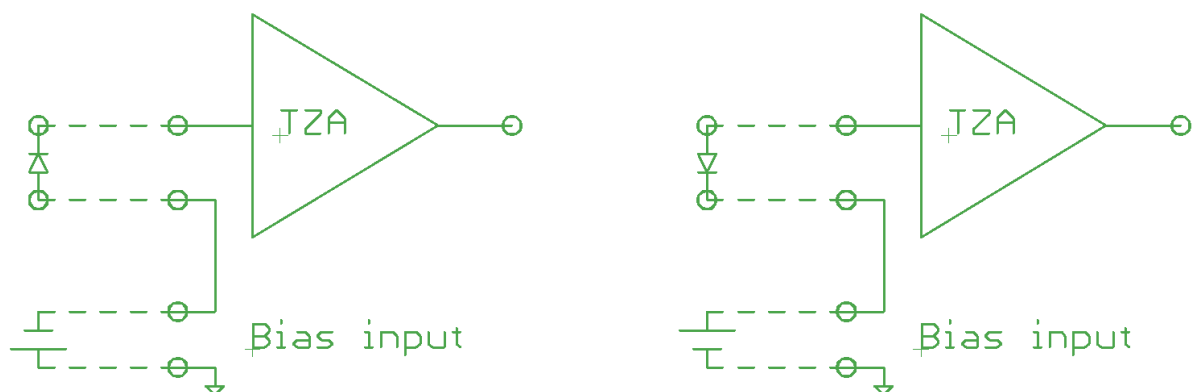

Figure 12: Schematic Diagrammes of Single-Ended Inputs with Bias Inputs

## 7.3 Gain

The amplifier has 6 gain ranges which may be selected via the appropriate menu in the GUI. These gain ranges are  $10^3\text{V/A}$ ,  $10^4\text{V/A}$ ,  $10^5\text{V/A}$ ,  $10^6\text{V/A}$ ,  $10^7\text{V/A}$  and  $10^8\text{V/A}$ .

Using the USB interface for direct communication, the gain can be selected with the commands V1, V2, ... V6.

Using the DB25 interface, the gain may be set via a bit pattern described in the appropriate table under „8 Hardwire Interface“, pg. 31.

## 7.4 Output Polarity

The TZA500 allows simple switching of the polarity of the output signal. This is valid for the analogue voltage outputs (BNC and DB25) as well as the values displayed on the GUI. This function is useful for ensuring a positive output when for example an external A/D-converter is used.

The polarity of the output may be selected via the appropriate menu in the GUI.

Using the USB interface for direct communication, the polarity can be selected using the command \$C.

Using the DB25 interface, pin 18 may be used to toggle the polarity:

LO: Signal is not inverted

HI: Signal is inverted

## 7.5 Bandwidth Reduction

The TZA500 has four selectable analogue bandwidth ranges. Reduction of bandwidth is useful for suppressing high frequency noise from slower signals. The full bandwidth of the amplifier is 10kHz. Using the bandwidth reduction, this may be reduced to 1kHz, 100Hz or 10Hz.

The bandwidth may be selected via the appropriate menu in the GUI.

Using the USB interface for direct communication, the bandwidth can be selected with the commands B1, B2, ... B4.

Using the DB25 interface, the bandwidth may be set via a bit pattern described in the appropriate table under „8 Hardwire Interface“, pg. 31.

## 7.6 Auto-Zero

The auto-zero function sets the momentary output signal to zero. In this manner, a constant overlying signal such as a background illumination or detector dark current may be eliminated. Small signal changes may now be detected more readily.

When this function is activated, the offset for each gain range is determined and stored internally. Note that depending on the amplitude of the signal immediately prior to the time of auto-zeroing, some gain ranges may be in an overload state. These gain ranges are then invalid following application of the auto-zero function because it is not possible to determine the offset required. The invalid gain ranges are greyed out in the gain menu and will not be activated if autogain is implemented.

**Note: the output signal must be positive in order to use this function!**

The auto-zero function may be activated via the pulldown menu “Options” in the GUI. Select “Auto-zero”.

Using the USB interface for direct communication, the auto-zero function is activated by a command \$A. The reset to normal operation is obtained with the command \$R.

Using the DB25 interface, the auto-zero is activated by a HI signal on pin 20. The reset to normal operation is obtained with a HI on pin 19 of the DB25 interface.

The value of the removed portion of the signal is output on pin 25 of the DB25 interface.

Activation of the auto-zero function does not affect the voltage range of the amplifier. For example, if the auto-zero is activated when 3V are output, then the output is reduced to 0V and the remaining dynamic range of the amplifier is 7V.

Pin 23 of the DB25 interface provides a logic control signal for this function. When the function is activated, this pin goes from HI to LO for the duration of the signal acquisition. When the signal is acquired and the auto-zero function complete, this pin goes HI again to indicate that the amplifier is now ready for operation.

## 8 Hardware Interface

The hardware interface (DB25 connector) is active upon starting the TZA500.

This interface has two galvanically isolated grounds. The analogue ground (pin 3) is the reference point for the analogue signals (pin 6 and pin 25). The digital ground (pin 9) is the reference for all digital inputs and outputs. It is recommended to not connect these two grounds in order to avoid slight disturbances and glitches which may be present on the digital lines.

The pinning of the DB25 interface is as follows.

Table 6: Pinning of the Hardware Interface (DB25)

Pin	Function	Pin	Function
1	n.c.	14	n.c.
2	n.c.	15	bandwidth reduction: BW = 1 kHz
3	AGND (ground for analogue signals)	16	bandwidth reduction: BW = 100 Hz
4	digital output: HI = power on	17	bandwidth reduction: BW = 10 Hz
5	digital output: HI = overload	18	polarity
6	Signal output (buffered equivalent to BNC output)	19	Auto-zero – Reset
7	n.c.	20	Auto-zero
8	n.c.	21	n.c.
9	DGND (ground for digital signals)	22	n.c.
10	Gain (LSB)	23	digital output: LO = load data LO→HI = auto-zeroing completed
11	Gain	24	n.c.
12	Gain (MSB)	25	Auto-zero offset value
13	n.c.		

Digital input or output

Analogue output

Table 7: Gain Setting via the Hardware Interface (DB25)

Range (full scale)	Gain [V / A]	Output scale	Pin 12 (MSB)	Pin 11	Pin 10 (LSB)
10 mA	$10^3$	1 V / mA	0	0	0
1 mA	$10^4$	10 V / mA	0	0	1
100 $\mu$ A	$10^5$	0.1 V / $\mu$ A	0	1	0
10 $\mu$ A	$10^6$	1 V / $\mu$ A	0	1	1
1 $\mu$ A	$10^7$	10 V / $\mu$ A	1	0	0
100 nA	$10^8$	0.1 V / nA	1	0	1

Table 8: Bandwidth Setting via the Hardware Interface (DB25)

Bandwidth	Pin 17	Pin 16	Pin 15
10 kHz	0	0	0
1 kHz	0	0	1
100 Hz	0	1	0
10 Hz	1	0	0

## 9 Installation of the Software Package

The installation of the software package is described in a separate document provided with the instrument.

## 10 Using the Application Software

The graphical user interface (GUI) is simple and easy to use. All of the important features can be reached directly in the main window. The main window comprises a pull down menu, a tool bar, the diagramme frame and a status bar.

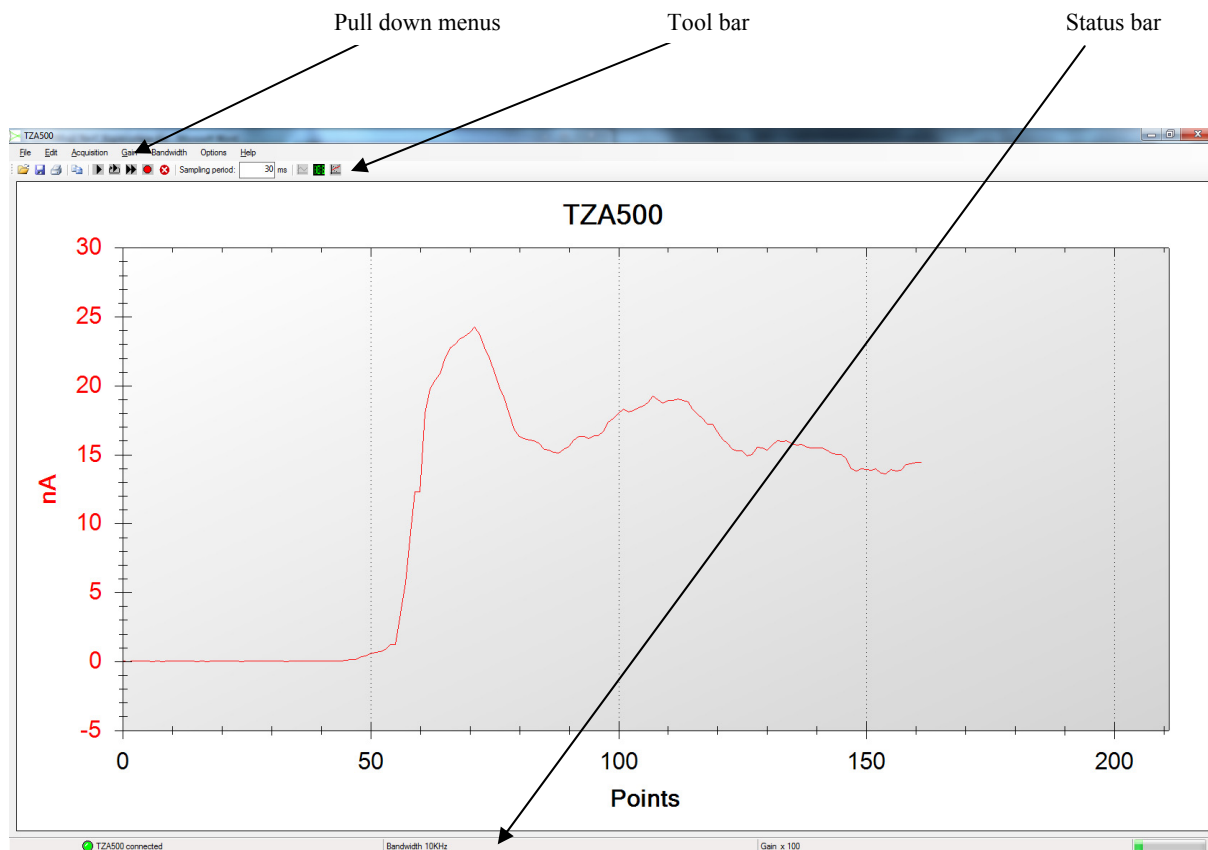

Figure 13: The Graphical User Interface (GUI)

### 10.1 The Functions of the Pull Down Menus

**File:**        **Open** – Loads a \*.TZA data format file.

**Save** – The programme allows saving measurement data in two formats: \*.TZA and \*.CSV. If a file name and folder have not been previously selected, the user will be prompted accordingly. If a file has previously been saved, this function will overwrite the file.

The \*.TZA format is specific for this application. The \*.CSV format is appropriate for exporting data into a format which can be read by Microsoft Excel and various other programmes. See “The \*.CSV Format”, pg. 39 for further information on this data format.



**Save as** – This function always prompts for the file name and folder. Otherwise identical to “Save”.

**Export** – Exports the present graph frame into a graphic file in one of the following formats: \*.emf, \*.png, \*.gif, \*.jpg, \*.tif oder \*.bmp.

**Print** – Prints the present graph frame using the printer selected in the following frame.

**Page setup** – Change the page formatting for the print.

**Preview** – Printer preview.

**End** – Ends the programme.

**Edit:** **Copy** – Copies the present graph frame into the PC's intermediate storage for further use with other programmes. For example, the graph can now be inserted into a text document using the paste function.

**Preferences**– Opens a new window in which various settings such as the sampling rate and user language can be made. For details, see „10.4 Preferences“ pg. 38.

**Acquisition:** **Start Logger Mode** – Starts a measurement. All measurement data are displayed at all times throughout the measurement. The latest data are displayed at the right edge of the graph. Each measurement point is numbered sequentially, displayed as the X-axis.

**Start Scroll Mode** – Starts a measurement. The graph displays a fixed number “n” of measurement data. The frame fills until “n” data points have been registered. Once “n” data points have been measured, the last “n” data are always visible, scrolling from right to left through the frame.

**Start Repeat Mode** – Starts a measurement. The graph displays a fixed number “n” of measurement data. The frame fills until “n” data points have been registered. Once “n” data points have been measured, the data is deleted and the frame fills again. This is equivalent to the display mode on a standard oscilloscope.

**Stop** – Stops a measurement.

**Clear Graph** – Clears the graph. This may also be performed during a measurement.

- Gain:**        **Gain x1 ... Gain x100.000** – Selects the electrical gain of the amplifier. The selected gain is indicated by a check mark. The actual gain of the amplifier is given by the gain multiplier times the base gain of  $10^3\text{V/A}$ . Thus in gain range “x1”, the gain is  $1 \times 10^3\text{V/A} = 10^3\text{V/A}$  and in gain range “x100.000” the gain is  $100,000 \times 10^3\text{V/A} = 10^8\text{V/A}$ .
- Auto Gain** – Automatically selects the optimum gain setting during the measurement. When active, the selected gain setting is also displayed.
- Bandwidth:**    **10kHz ... 10Hz** – Selects the electrical bandwidth of the amplifier. This is useful for optimizing the signal-to-noise ratio when the full bandwidth of the amplifier is not required.
- Options:**        **Auto-Zero** – The auto-zero function sets the momentary output signal to zero. This function is only applicable for positive signals. When this option is activated, the offset for each gain range is determined and stored internally. Note that depending on the amplitude of the signal immediately prior to the time of auto-zeroing, some gain ranges may be in an overload state. These gain ranges are then invalid following application of the auto-zero function because it is not possible to determine the offset required. The invalid gain ranges are greyed out in the gain menu and will not be activated if autogain is implemented.
- Auto-Zero reset**– Resets this function and restores the amplitude. All gain ranges are reset to the valid state and are available for autogain implementation.
- Inverting** – Inverts the input.
- Noninverting** – Sets the input to noninverting.
- Help:**            **Info** – Shows information about this programme.
- TZA Info** – Shows information on the present instrument connected, including its model and serial numbers as well as the firmware version.

## 10.2 The Tool Bar

The tool bar allows for quick access to the most important functions.

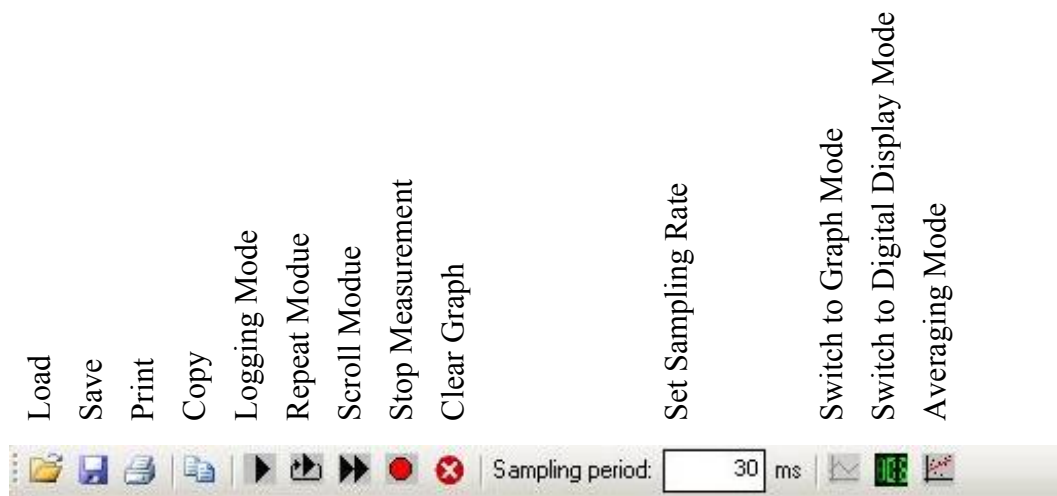





Figure 14: The Tool Bar

The file handling functions (Load , Save , Print  and Copy ) are identical to the corresponding sub menus in the pull down menus.

To the right of these are buttons to control the data acquisition.

**Logging Mode:** Starts a measurement in logging mode. All of the data since the last use of the “Clear Graph” function are displayed in one continuous graph. This mode is useful for observing long term effects.



**Repeat Mode:** Starts a measurement in repeat mode. The graph frame displays data until the frame is full. Then the graph is immediately cleared of data and begins to fill again. The length of the data set which will fill the graph is selected in the field “Graph width (Repeat and Scroll mode)” of the “Preferences” menu (see „10.4 Preferences “ pg. 38). Note that the repeat mode emulates the function of a standard oscilloscope. Note further that the data are not stored in repeat mode. Thus, when switching to logging or scroll mode, the data acquisition begins anew.



**Scroll Mode:** Starts a measurement in scroll mode. The graph frame displays data until the frame is full. Then the graph remains full showing only the last portion of data recorded. The graph “sweeps” along with the data acquisition. The length of the data set which will fill the graph is selected in the field “Graph width (Repeat and Scroll mode)” of the “Preferences” menu (see „10.4 Preferences “ pg. 38). Since the data are in fact stored, switching between scroll mode and logging mode is possible without data loss.



**Stop:** Stops a measurement. The measurement may be restarted with no loss of data in the logging mode. Restarting with repeat or scroll mode results in a complete loss of data and a new start of data acquisition.



**Clear Graph:** Clears all of the data in the present graph. If this button is selected during data acquisition, the data are cleared but the acquisition process is not halted.



In addition, there are input fields for the sampling period in ms, as well as buttons to select the mode of display (digital and graph modes).

**Sampling Period:** The period of time between two samples can be selected and displayed. This is also accessible in the “Preferences” frame of the „Edit“ pull down menu.

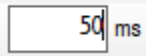

**Graph:** This is the default display mode when the programme starts. The measurement results are displayed graphically:  
Y-axis = measured value; X-axis = sample number.



**Digital Display:** The last measured value is displayed in a large digital display.



**Averaging Mode:** This function serves to reduce noise or fluctuations in the signal. When activated, the software calculates the average of the selected number of measurements before displaying this value. The update rate is unaffected since for the calculation of the next point, the “oldest” measurement datum is replaced by the “newest”. The number of measurements for averaging can be set in the “Preferences” frame of the “Edit” pull down menu.



## 10.3 The Status Bar

The most important status information is displayed here.

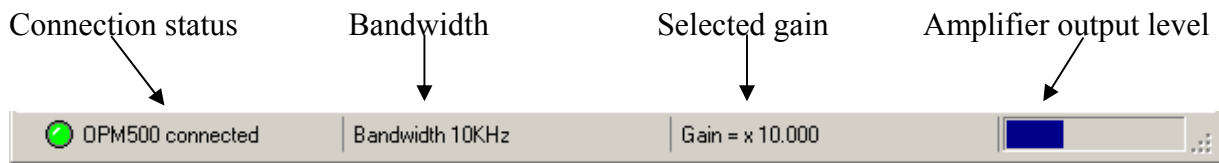
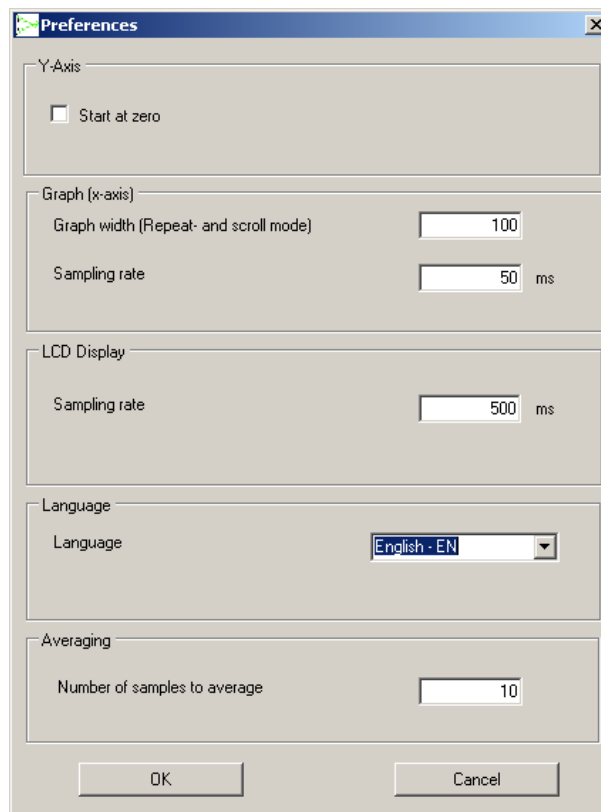

Figure 15: The Status Bar

- Connection status:** Indicates whether a TZA500 instrument is connected and all relevant connection parameters could be set properly. If a connection error occurs, the fault is indicated here and highlighted with a red virtual indicator lamp.
- The programme will only function if the virtual indicator lamp is green and the status “TZA500 connected” appears. Disconnection will also be recognized and indicated during a running measurement.
- Gain:** Indicates the presently selected gain – also in autogain mode.
- Bandwidth:** Indicates the selected bandwidth of the amplifier. The bandwidth may be reduced in order to reduce noise from sources of higher frequency than the signal of interest.
- Amplifier level:** For optimal signal to noise ratio, as with any measurement instrument, the TZA500 should not be used in the extreme lower range of its output. If the unit is used in the extreme upper range of output, clipping may occur. A coloured sliding graph bar is used to warn the user of the present amplifier output level (which is not directly visible in the measurement data). The autogain mode will always drive the unit in the optimum gain setting.
- Under Win XP, the optimum operating range is indicated by a blue bar. If the bar is displayed in red, the gain selection should be changed as appropriate. Under Win 7 the bar is always green and does not indicate overload.

## 10.4 Preferences

In addition to the settings in the tool bar, there are several which will not be required during normal operation and will usually be set once when first setting up the instrument. These settings are found in the pull down menu “Edit” under “Preferences”. The following window then appears:



- Y-Axis, Start at zero:** When using automatic Y-axis scaling, the lower limit of the Y-axis will lie just under the smallest measurement value. Activating this check box will force the lower limit to be fixed at zero. This function may only be used for positive signals.
- Graph width:** A fixed number of samples are displayed in repeat and scroll mode. This number can be set here.
- Sampling rate:** Sets the period of time between samples. Different sampling rates can be set for the scope and the digital display modes (“LCD Display”).
- Language:** Selects the language for the graphical software interface. The appropriate Font must be installed under Windows in order to ensure correct representation.
- Averaging:** A button in the toolbar allows activation of the averaging mode. The number of measurements to be averaged is selected here.

## 10.5 Data Formats

### 10.5.1 The \*.TZA Format

The software uses three formats for saving and loading data. The programme specific format \*.TZA uses ASCII characters. The file header contains the date and the units of the data values. The measurement samples are separated by semicolons.

The file structure is as follows:

```
Date and time : <Date and time of measurement>
Unit: <Unit>
<Sample 1>;<Sample 2>;<Sample 3>;...
```

### 10.5.2 The \*.CSV Format

The \*.CSV format is useful for data export or use with other programmes. These files can be loaded directly into spread sheet programmes such as Excel. The file header is identical to that of the \*.TZA files.

```
Date and time : <Date and time of measurement>
Unit: <Unit>
0;<Sample 1>
1;< Sample 2>
2;< Sample 3>
3;< Sample 4>
...
```

## 10.6 The Graph

The graph mode is the default mode which will appear when starting the programme. The X-axis represents the sample number of a measurement sequence, the Y-axis represents the measured current. The units of current automatically adjust to the level being measured.

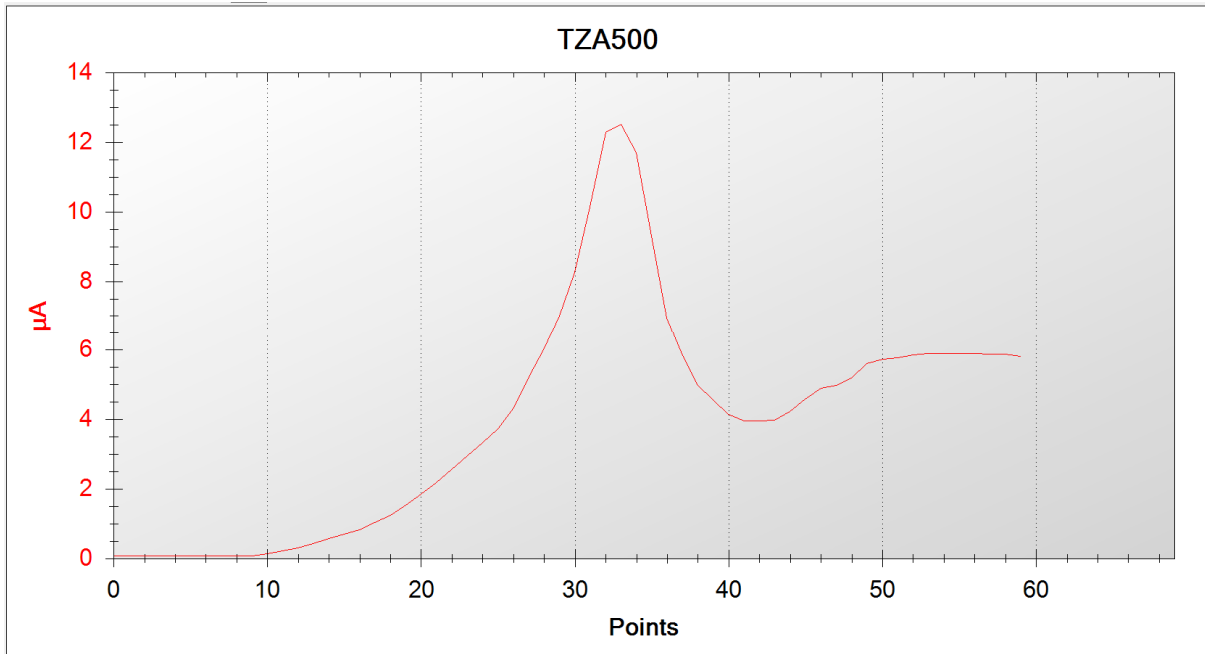

A dynamic zoom can be activated by clicking in the graph window and dragging a box to the size of the desired zoom. If the automatic rescaling is activated, the next measurement will rescale the window to its previous representation. Therefore, if the zoom is to be kept active, the automatic rescaling must be deactivated first (context menu) or the measurement stopped.

If the cursor is moved over a given sample in the graph, an information box will appear with the sample values:

Channel 1 is 6,33µA at Point No. 54,0

This option can be activated and deactivated using the context menu:

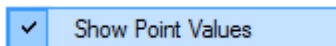



### 10.6.1 The Context Menü

The context menu is opened by a right click within the graph frame.

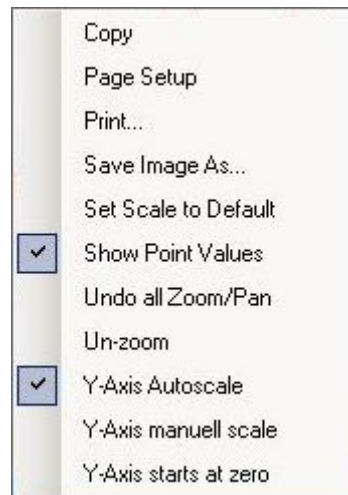

Copy	A picture of the graph is stored to the PC's temporary storage. It may be copied into other programmes for documentation purposes.
Page Setup	Page setup for printing.
Print...	Opens the print control window for output to a printer.
Save Image As...	Saves a picture of the graph to a file.
Set Scale to Default	Resets the graph axes to their default values.
Show Point Values	Activates or deactivates the mouse-over pop-up box with the sample data information.
Undo all Zoom/Pan	Resets all zoom and pan settings.
Un-zoom	Resets the last zoom and pan setting.
Y-Axis Autoscale	Activates automatic rescaling of the Y-axis (unless the „Y-Axis starts at zero“ option is activated).
Y-Axis manual scale	Opens an input box in which the upper and lower limits of the Y-axis can be manually fixed. This deactivates the autoscaling.
Y-Axis starts at zero	Fixes the lower limit of the Y-axis to zero. This setting remains active in autoscaling mode, in which case only the upper limit is automatically rescaled.

## 10.7 The SDK Package

The TZA500 comes with a software development kit (SDK package) in order to ease integration of the instrument into OEM projects. This package includes the source code of the application programme (written in Microsoft VB.net version 2005) as well as a LabVIEW<sup>®</sup> VI example.

The SDK package is found on the storage media delivered with the instrument.

## 10.8 Source Code of the Application Programme

The project file TZA500.sln is stored on the storage media delivered with the instrument. This file contains all of the necessary window files, modules, graph and icon files as well as the necessary compiling settings. This file may be loaded into the software development environment.

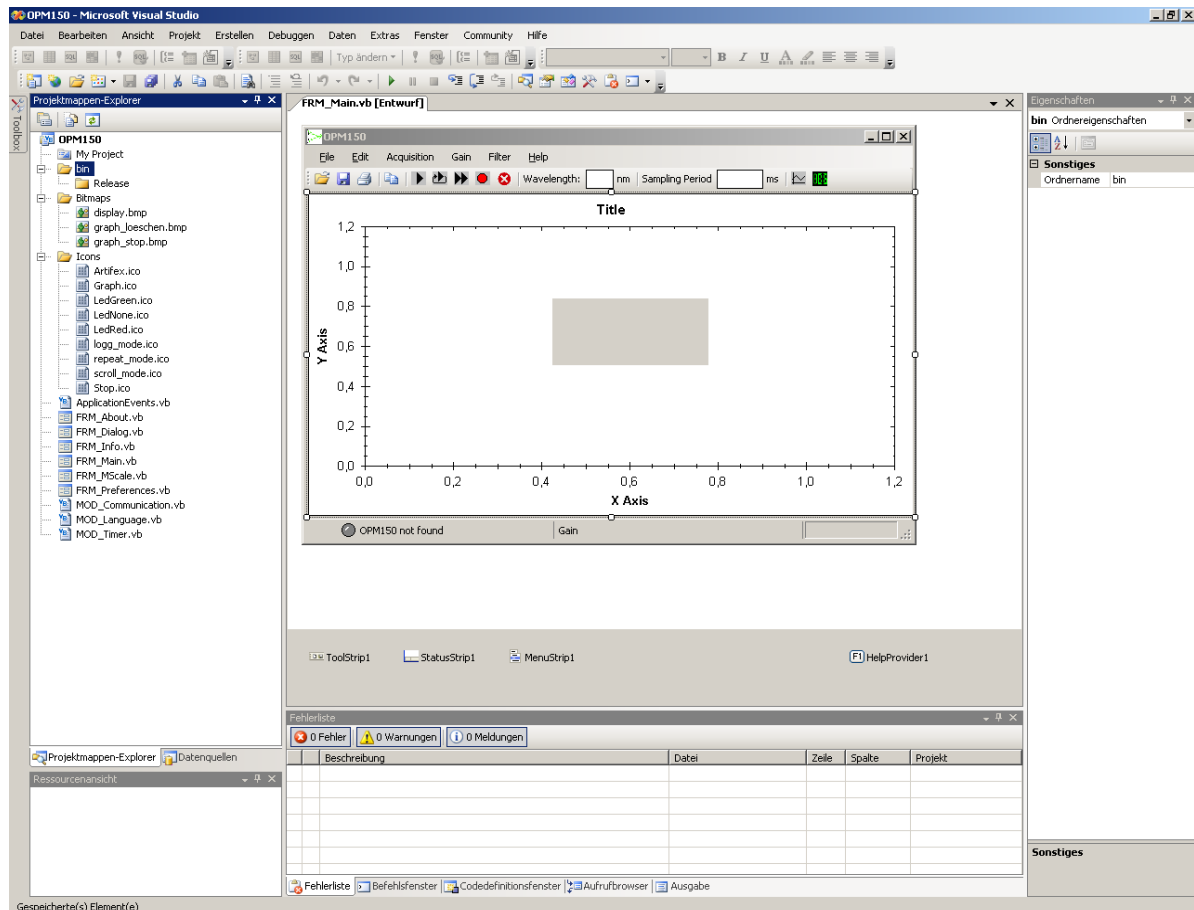

All enclosed files are shown in the project explorer (lower left window). The folder structure is the same as is found on the storage media delivered with the instrument.

<sup>®</sup> „LabVIEW“ is a registered trade mark of the National Instruments Corporation.

The graph in the main window is generated by embedding the file Graph.dll in the output. For more information, see Hinweis.txt.

The programme comprises 6 windows which contain the source code. There are three further modules responsible for the following features:

**MOD\_Communication:** This module governs the communication with the TZA500 via the driver libraries. The data are preprocessed before sending and after receiving. For efficient use of the PC's resources, the send and receive routines are contained in their own thread.

**MOD\_Language:** Governs the language settings. The vocabulary is stored in strings which are called as required.

**Mod\_Timer:** This module is responsible for the software triggering of the instrument. The PC timer is used for accurate sampling rate control.

Further details are contained in the comments in the source code.

## 10.9 Demo Programm in Labview

A LabVIEW demonstration VI is supplied with the instrument to ease integration into LabVIEW environments. The programme is found in the folder \SDK\Labview. All relevant sub-VIs are in the subfolder libraries.

Please note that this is a demonstration programme only and is not intended to replace the fully functional main application software. The VI is capable of measuring, setting gain, wavelength correction and display of error messages. Instrument information can also be read out and displayed.

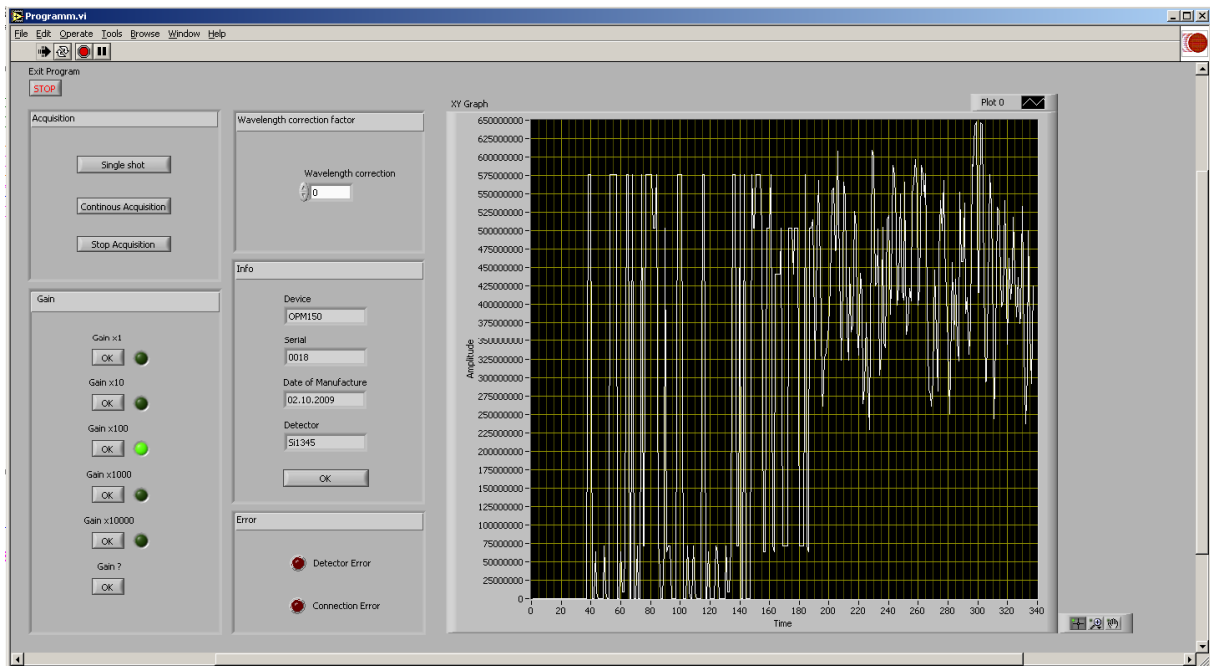

The programme diagramme contains a loop for receiving and calculating data as well as a loop for sending commands.

Both loops are executed until the “Stop” button is pressed. If the programme is stopped via the pull down menu or the tool bar, then the USB port will not be freed for other applications. In this case, the USB cable must be removed from the PC (or the TZA500) and then reconnected.

## 11 Communication with the TZA500

In order to communicate with the TZA500, the driver can be integrated directly into an existing project. Two examples have been given in the description of the SDK package.

A simpler method is by designating a COM-port. The driver can generate a virtual port in the control panel. One disadvantage of this method is the fact that the PC will designate a port number according to the free ports available. Then the user must use this port number in the programme code, otherwise communication will not be possible.

### 11.1 Communication Protocol

The communication parameters for the TZA500 are:

Baud rate: 115200 Bits/s  
Data bits: 8  
Stop bits: 1  
Parity: none  
Flow control: none

The communication uses ASCII-characters. As an example, communication via the programme “Hyperterminal” can be realized. This programme is found under:

Start > Programs > Accessories > Kommunikation > Hyper Terminal

Active VCP is necessary for this communication (see “Activating the VCP-Option” in the software installation manual).

When prompted, enter a name for the connection (any name will do) and select the proper port number.



The communication parameters must now be entered in the following window.

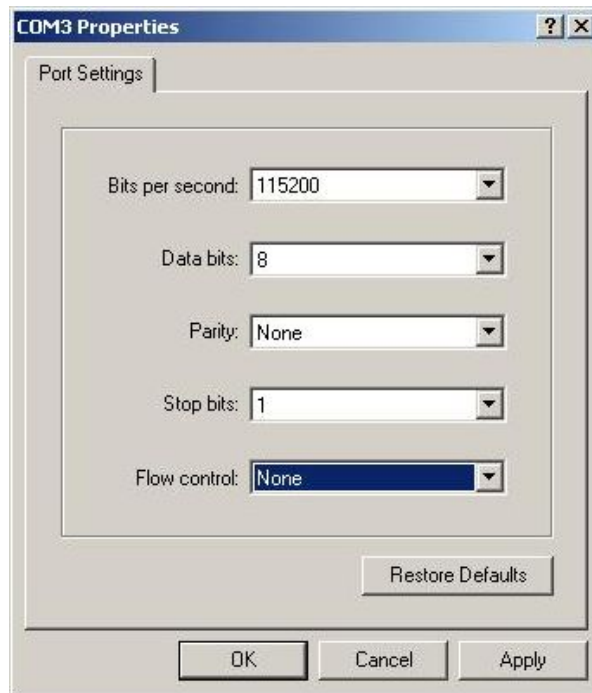

Confirm the changes by clicking „OK“.

If all parameters are correct, an indication will appear at the bottom of the main window that the connection has been successful. This may be checked by typing “\$U”. The TZA500 responds with “U-OK”.

**NOTE: The active interface when turning on the TZA500 is always the DB25 hardware interface! No commands over the USB interface will be received! The command “\$U” must first be sent in order to switch control over to the USB interface.**

Now enter \$I (“dollar” and capital “i”, this is the code to request information about the instrument). The TZA500 will respond with a message similar to the following:

```
TZA500  
Serial: 0001  
Date of Manufacturing: 02.10.2009
```

The commands “\$E” (single measurement sample) and “\$P” (continuous measurement at 1.5 kS/s) generate measurement data. The output is in the form I 10uA . These values represent the current measured by the detector head.

## 11.2 Command Structure

### 11.2.1 Change Interface

\$T TTL Interface. The DB25 hardwire interface is activated. Control is made using TTL-compatible signals (Default interface on startup).

**Response:** T OK

\$U USB Interface. Control is made using the USB interface.

**Response:** U OK

### 11.2.2 Data output

\$P : Polling mode. The measurement takes place continuously at approximately 1.5 kS/s. Sending „\$“ ends the measurement.

\$E : Single measurement mode. One single data sample is measured.

**Response:**

**I<value><units in nA/uA> e.g. I3uA means a current of 3µA.**

### 11.2.3 Auto-Zero Function

\$A Auto-zero activated. The momentary output signal is set to 0V (operative only on positive outputs). When this option is activated, the offset for each gain range is determined and stored internally. Note that depending on the amplitude of the signal immediately prior to the time of auto-zeroing, some gain ranges may be in an overload state. These gain ranges are then invalid following application of the auto-zero function because it is not possible to determine the offset required. The invalid gain ranges are greyed out in the gain menu and will not be activated if autogain is implemented.

**Response:** Gain: <valid gain ranges>

\$R Auto-zero reset. Die Auto-zero function is deactivated. The output returns to normal operation. All gain ranges are reset to the valid state and are available for autogain implementation.

**Response:** R OK

### 11.2.4 Polarity

\$N Not inverted. (Default setting).

**Response:** N OK

\$C Inverted. The signal is inverted in the input stage.

**Response:** C OK

**\$F Request present polarity status**

**Response:** F0 (not inverted)

F1 (inverted)

### 11.2.5 Bandwidth

B1 bandwidth 10KHz (default)

B2 bandwidth 1KHz

B3 bandwidth 100Hz

B4 bandwidth 10Hz

**Response:** B <Bandwidth> OK

**B?** Request present bandwidth status

**Response:** B <Bandwidth>

### 11.2.6 Info

\$I : Information about the system, serial number and date of manufacture.

**Response:**

<Instrument> e.g. TZA500

Serial: <serial number.>

Date of Manufacturing: <date of manufacture>

### 11.2.7 Gain

V1 gain x1

V2 gain x10

V3 gain x 100

V4 gain x 1.000

V5 gain x 10.000

V6 gain x 100.000

**Response:** V<gain> OK

**V?** Request present gain status

**Response:** V<gain> e.g. V1



## 12 Damage

The unit may be damaged by exceeding the maximum average input power. Please read „4 Absolute Maximum Ratings”, pg. 19 for these maximum values before working with the instrument.

### 12.1 Troubleshooting

In the event that a measurement is not successful, the following possibilities should be analysed:

Symptom	Possible Errors	Correction
No output	<ul style="list-style-type: none"><li>• System is not connected to the USB port</li></ul>	<ul style="list-style-type: none"><li>• Connect the unit to the USB port</li></ul>
No output	<ul style="list-style-type: none"><li>• Input power too low</li><li>• Input or output connection not correct</li></ul>	<ul style="list-style-type: none"><li>• Increase input power</li><li>• Ensure that the connectors are inserted correctly and locked.</li></ul>
Output at full scale, independant of input current	<ul style="list-style-type: none"><li>• Input power too high</li></ul>	<ul style="list-style-type: none"><li>• Reduce input power.</li></ul>

In the unlikely event that you are not able to obtain a measurement in spite of these troubleshooting measures, please contact us. We will be pleased to help you solve your problem.

## 13 Disposal

Do not dispose of the TZA500 with the household waste. The worn out unit can be taken to an electronics and metal recycling centre for disposal. The manufacturer also accepts old units for disposal.



### NOTICE!

#### **Danger for the environment from improper disposal!**

Dangers for the environment can arise through improper disposal.

- Never dispose of the electronic ballast with the household waste.
- Take the electrical scrap or electronic components to an approved specialist company for disposal.
- In case of doubt, contact the local authorities or a special disposal company for information about the environmentally compatible disposal.

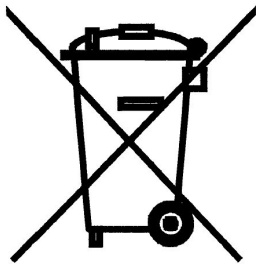

## 14 Type plate

The type plate is located on the back of the enclosure and includes the following information:

- Manufacturer
- Model number
- Article number
- Serial number
- Manufacturing date

	<b>TZA500</b>
Model-No.:	TZA500SB
Article-No.:	30.100.00025
Ser.-No.:	00xx
Date of Manufact.:	xx/16
www.artifex-engineering.com	CE

## 15 Notice

Artifex Engineering reserves the right to make changes to its products or to discontinue any product or service without notice and advises customers to obtain the latest version of relevant information to verify, before placing orders, that information being relied on is current and complete. All products are sold subject to the terms and conditions of sale supplied at the time of order acknowledgement, including those pertaining to warranty, patent infringement and limitation of liability.

Customers are responsible for their applications using Artifex Engineering components.

Artifex Engineering assumes no liability for applications assistance or customer product design. Artifex Engineering does not warrant or represent that any license, either express or implied, is granted under any patent right, copyright, or other intellectual property right of Artifex Engineering covering or relating to any combination, machine, or process in which such products or services might be or are used. Artifex Engineering's publication of information regarding any third party's products or services does not constitute Artifex Engineering's approval, warranty or endorsement thereof.

Artifex Engineering does not approve use of this product in medical instrumentation or applications.



**DANGER!** The TZA500 series of transimpedance amplifiers may be used with lasers. Personnel who use this instrument must, therefore, be instructed in the safe use of lasers and laser beams.

**Always wear the proper laser safety glasses designed for the laser in use!**

**Never allow the direct or reflected laser beam to impinge on the eyeball or to come into contact with the skin!**