

GW M5

WATER MIST NOZZLE

K-5, LOW PRESSURE, NON-AUTOMATIC



DESCRIPTION

The **GW M5** is a compact low pressure water mist nozzle specifically developed for use in total and local protection water mist fire extinguishing systems – both for marine and land based applications.

The nozzle is designed to efficiently produce a fine mist of small water droplets at low pressure (3,5 to 16 bar). This makes the nozzle suitable for a large variety of fire protection applications, where fuel pool and high pressure spray fires may occur. Relevant applications are:

- engine rooms
- engine test bench
- turbine enclosures
- paint booths
- cable tunnels
- switch board installations
- other enclosed occupancies with limited draft conditions, suitable for fire-protection with water mist.

If required, the GW M5 water mist nozzle can be used in AFFF (aqueous film forming foam) enhanced systems.

BLOW-OFF CAP

The GW M5 water mist nozzle is fitted with a robust stainless steel protective cap to prevent any damage to the deflectors during handling, installation and service. The protective cap is specification tested by FM and is designed to remain in place after nozzle installation, thus effectively protecting the nozzle orifices from clogging caused by external contamination.

The protective cap is fitted with a high quality virgin PTFE bush to provide reliable low friction ejection (Blow-Off) when the water mist system is activated and water is discharged.

FILTER/STRAINER

The GW M5 water mist nozzle is as standard fitted with a SS316 wire mesh strainer in the nozzle inlet, to prevent water born debris from entering the nozzle and clogging of the orifices.



Data Sheet: GW M5 Water Mist Nozzle

Page: Page 1 of 6

DATA SHEET No: **SN010 1001 C**

Date: 10 May 2017

GW M5

WATER MIST NOZZLE

K-5, LOW PRESSURE, NON-AUTOMATIC



GW SPRINKLER A/S

TECHNICAL DATA

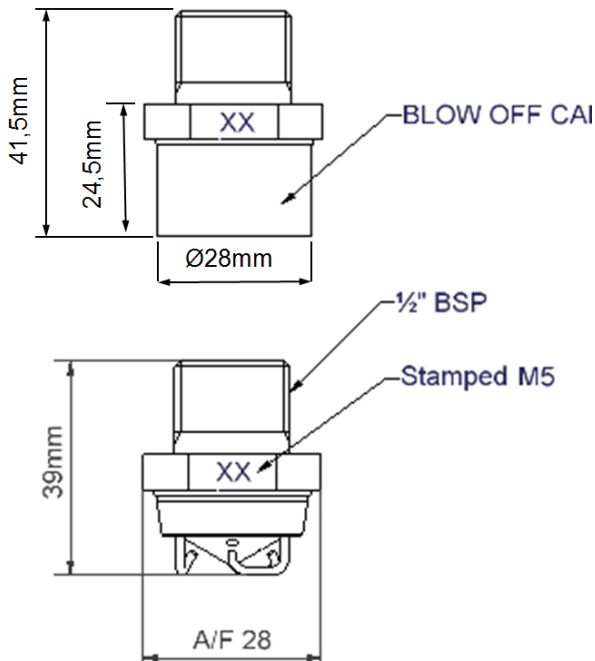

K-factor	5 (metric) / 0,34 (imperial)
Spray Angle	90°
Droplet Size	See table (below)
Materials	
Nozzle Body	Brass, SnNi-plated or SS316
Deflector	SS316
Strainer	SS316
Protective Cap	SS304
Bush	Virgin PTFE
Weight	98 g
Thread	1/2" BSPT
Working Pressure	3,5 to 16 bar
For use with	Fresh Water, Sea Water or Foam (AFFF) enhanced water

Working Pressure	DROPLET SIZE (µm)		
	BAR	D _{V90}	D _{V50}
3	277	171	69
7	250	151	55
12	247	138	50

PRESSURE / FLOW GRAPH

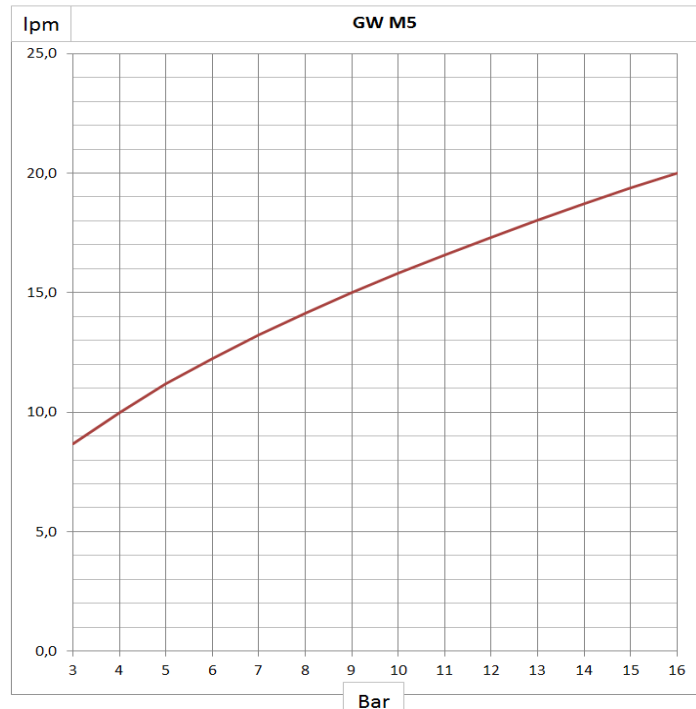

Data Sheet: GW M5 Water Mist Nozzle

Page: Page 2 of 6

DATA SHEET No: **SN010 1001 C**

Date: 10 May 2017

GW M5

WATER MIST NOZZLE

K-5, LOW PRESSURE, NON-AUTOMATIC



GW SPRINKLER A/S

INSTALLATION

Nozzles and pipe system should be installed by people, who have the necessary skills and understanding of installing water mist sprinkler systems. The installers should be familiar with GW Manual No. 846 M5 / Local Application Fire Protection of Category A Engine Rooms – IMO / MSC.1/Circ. 1387, and they should be aware of the risks of system mal-function, if the instructions and precautions listed in the manual are not followed.

Nozzles should be installed in such a way that installation heights, nozzle distances and water pressures, as listed in table 1 and Fig A1, are satisfied.

Table 1

Key parameters	Specific for GW Model M5 Nozzles (local protection)		
Min. distance between nozzle and object	0,5m (vertical)		
Max. distance between nozzle and object	14,5m (vertical)		
Vertical installation heights above fire risks / minimum water pressure on pendent nozzles:	Installation height	Water pressure	
	0.5m - 8m	3.5 - 10 (bar)	
	8m - 14.5m	9 - 10 (bar)	
Maximum nozzle spacing for vertically installed nozzles:	3m between nozzles		
Maximum distance to wall	½ spacing = 1,5m		
Maximum nozzle to ceiling distance	1m (according to FM Class 5560, total protection)		
Maximum compartment volume	3.350m ³ (according to FM Class 5560, total protection)		
Minimum water flows and water densities for nozzles installed in the pendent position:	Installation height over the fire risk (m)	Min. water flow from each nozzle (l/min)	Min. water density on application footprint (mm/min)
	0.5 – 8,0	9.4	1.0
	8.0 - 14.5	15	1.7
Maximum obstructions between pendent installed nozzles and fire risk (obstructions larger than 0.5m wide) before additional nozzle should be installed.	The object seen from single nozzle must not obstruct more than 20° of the spray The object seen from the fire risk must not obstruct more than 20° of the spray.		
Horizontally installed nozzles	See chapter 2.5 of Manual no. 846		
Nozzle pipes	GW recommends the use of stainless steel pipes for nozzle pipes. Systems shall be hydraulically calculated.		
System in-line strainer	A strainer (Y or Basket) with a mesh sizes of max. 1.5mm should be installed at the nozzle pipe inlet.		

Nozzle pipe work should be hydraulically calculated to ensure that the water pressure satisfy the recommended water pressure on all nozzles in an activated nozzle zone.

Nozzle pipe system should be made in materials, which are corrosion proof to the extinguishing agent, and which do not cause galvanic corrosion between pipes and components, or pipes and pipe supports.

GW Sprinkler recommends the use of stainless steel for nozzle pipes.

Nozzle pipe support must be designed to withstand vibrations and movement, which might occur on ships at sea.

Nozzle pipes and other pipe-works should be designed and installed in such a way, that the pipe works do not interfere with the normal use and maintenance, which take place in the space.

Nozzle pipe-systems should be designed in such a way that nozzles are only installed so that there is no risk of damaging the pipe system, or the nozzles.

Data Sheet: GW M5 Water Mist Nozzle

Page: Page 3 of 6

DATA SHEET No: **SN010 1001 C**

Date: 10 May 2017

GW M5 WATER MIST NOZZLE

K-5, LOW PRESSURE, NON-AUTOMATIC

Nozzle pipes should, when possible, be installed above hoists and other moving equipment. Nozzle pipe-work should be installed away from door openings and hatches, and other areas where nozzle pipes or nozzles may limit the free movement of personal in the engine room. Nozzle pipe-work should be installed away from machinery and areas where maintenance often takes place, or where there is a risk that the nozzle spray might be obstructed. Nozzle pipes and nozzles should be installed in such a way that it is not necessary to dismantle pipes or nozzles in order to maintain or repair machinery or application in the engine room. Before installation of the nozzles, it should be checked that the female nozzle fittings are positioned in such a way that the nozzles will be correctly positioned. This is easily done with a ½" BSP threaded pipe temporarily screwed into the fitting to indicate the nozzle direction. Nozzles should only be installed in the pipe work, after that the full pipe-work has been installed and fully secured, and after all internal water-ways have been rinsed for impurities, and dried with compressed air. Nozzles should be installed using a nozzle spanner for the M-series nozzles. The nozzle protective cap should be left on while and after installing the nozzles, to prevent the risk of damaging the nozzles. Nozzles should be tightened to the pipe system ½" female BSP thread applying a torque of 4 Nm ± 1Nm. If a nozzle deflector pin is bent off-center to the orifice hole, or knocked up against the orifice hole, the nozzle will not distribute the water correctly. Such damaged nozzles should immediately be replaced with new. When installing nozzles and pipes, it is important only to apply thread sealant on the male thread parts, and to ensure that there is no excess sealant internally in the pipe system. This is important to avoid orifices from clogging. Threaded female parts should be firmly cleaned before assembled with male parts, to avoid any impurities in the pipe.

Fig A1 – Nozzle Spacing and distance to object

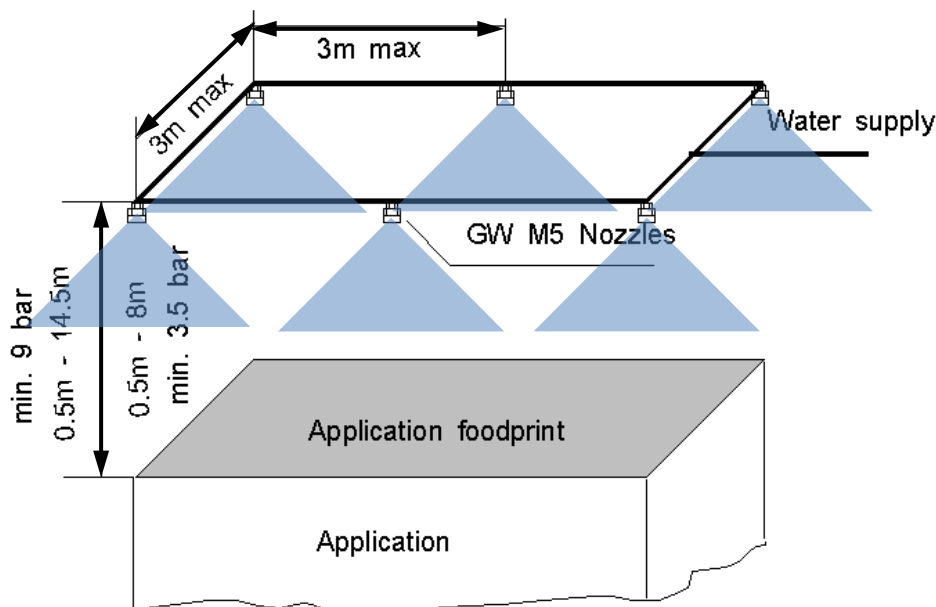

Fig A1 Nozzle System

GW M5

WATER MIST NOZZLE

K-5, LOW PRESSURE, NON-AUTOMATIC



MAINTENANCE AND INSPECTION









The GW M5 water mist nozzle shall be maintained and inspected according to NFPA 750 and NFPA 25. Special attendance shall be given to any signs of damage and corrosion. The protective cap shall be removed to visually inspect the deflector pins integrity – i.e. correct position = ~1,2mm over, and concentric to, the orifices. A representative number of nozzles shall be unscrewed from the pipework and the nozzle inlet strainer checked (and if necessary cleaned) for any blockage. Damaged, painted or corroded nozzles must be replaced with new identical type nozzles.

TESTING

The GW M5 water mist nozzle has been tested by recognized 3rd party laboratories:

Laboratory	Test Type	Test Code	Test Content
FM	Specification Test	IMO MSC/Circ. 668/728	Component test
FM	Approval Test	Water mist systems for the protection of machinery spaces and special hazard machinery spaces in enclosures with volumes not exceeding 118,300 ft ³ (3350m ³)	System test – FM Class 5560
FM	Specification Test	IMO MSC/Circ. 668/728	Component test – Protective Cap
SINTEF	Approval Test	IMO MSC/Circ. 668/728	Fire Extinguishing Test
SINTEF	Approval Test	IMO MSC/Circ. 913	Fire Extinguishing Test
RIME	Specification Test	Generator, Motor, Panel	IP22 – Impingement Test

APPROVALS

	Bureau Veritas	FIXED WATER BASED LOCAL APPLICATION FIRE FIGHTING SYSTEMS COMPONENTS FOR USE IN CATEGORY “A” MACHINERY SPACES – IMO MSC.1/CIRC 1387
	MED Bureau Veritas	FIXED WATER BASED LOCAL APPLICATION FIRE FIGHTING SYSTEMS COMPONENTS FOR USE IN CATEGORY “A” MACHINERY SPACES – IMO MSC.1/CIRC 1387
	DNV-GL	APPROVED FOR USE AS A FIXED WATER BASED LOCAL APPLICATION SYSTEM FOR MACHINERY SPACES OF CATEGORY A - IMO MSC.1/CIRC 1387
	Lloyd's Register	FOR USE IN MACHINERY SPACES OF CATEGORY A OF VOLUME GREATER THAN 500M3 FOR PROTECTION OF LOCAL HAZARDS - IMO MSC.1/CIRC 1387
	CHINA CLASSIFICATION SOCIETY	FIXED WATER-BASED LOCAL APPLICATION FIRE FIGHTING SYSTEM - IMO MSC.1/CIRC 1387
	CLASS NK	NOZZLE FOR FIXED LOCAL APPLICATION FIRE FIGHTING SYSTEM - IMO MSC.1/CIRC 1387
	USCG	WATER MIST FIRE EXTINGUISHING SYSTEM – LOCAL APPLICATION WATER MIST NOZZLE - IMO MSC.1/CIRC 1387
	RINA	LOCAL APPLICATION FIRE FIGHTING SYSTEM FOR HIGH FIRE RISK AREAS IN MACHINERY SPACES OF CATEGORY A - IMO MSC.1/CIRC 1387

NOTE: Approval status may be subject to change. Please consult GW Sprinkler for actual status.

Data Sheet: GW M5 Water Mist Nozzle

Page: Page 5 of 6

DATA SHEET No: **SN010 1001 C**

Date: 10 May 2017

GW M5
WATER MIST NOZZLE
 K-5, LOW PRESSURE, NON-AUTOMATIC

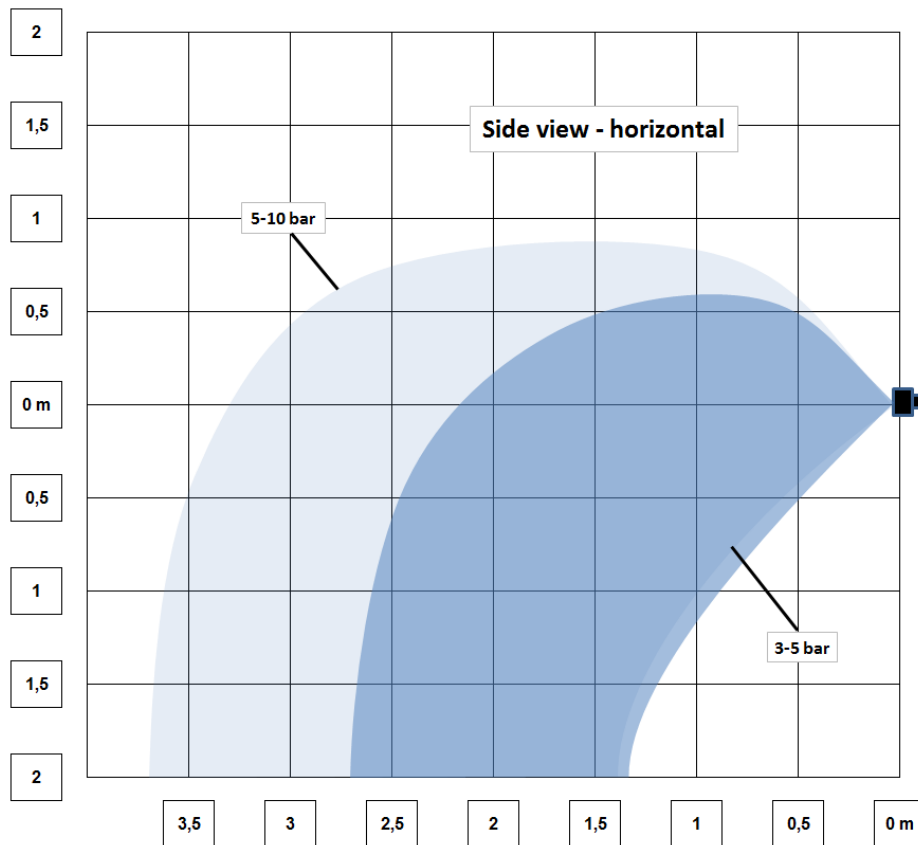
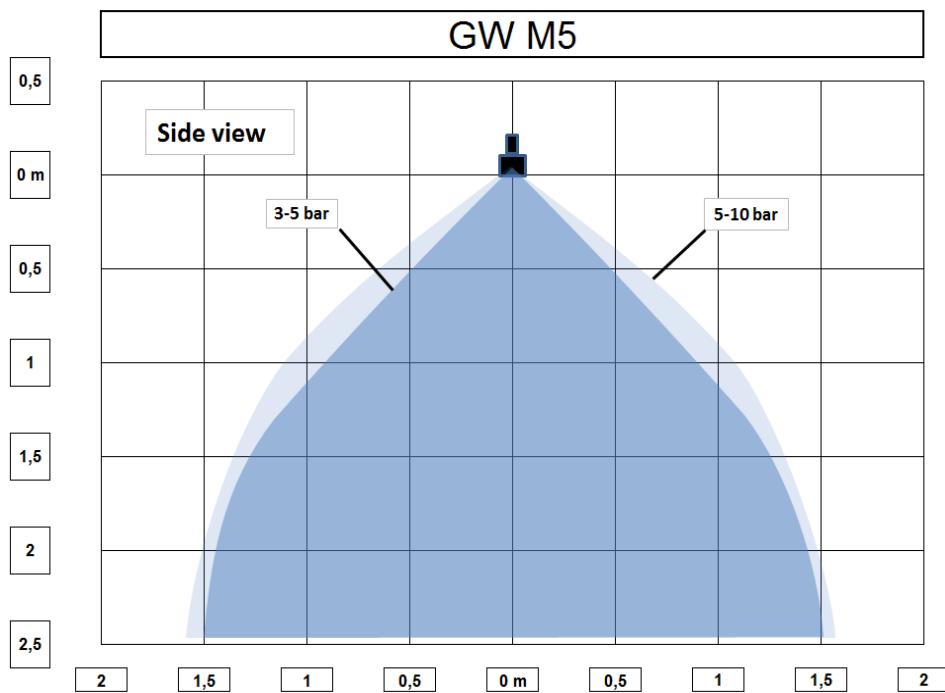

Data Sheet: GW M5 Water Mist Nozzle

Page: Page 6 of 6

DATA SHEET No: **SN010 1001 C**

Date: 10 May 2017