

Small room fans. Premium design with maximum energy efficiency.



MiniVent[®] M1 with ultraSilence[®] technology.

Watertight building envelopes and contaminating environmental influences make mechanical ventilation indispensable nowadays. The traditional ventilation of an apartment or workplace by opening the window is no longer an effective solution and it wastes valuable energy.

The small room fans MiniVent M1 stand for the highest pressure performance, lowest noise levels and maximum energy efficiency.

Two performance levels, jet water protection IPX5 and high-quality long-life ball bearings are standard equipment features with clear added value.

Equipped with Helios ultraSilence technology, MiniVent operates almost silently and consumes around a third less energy than conventional small room fans.

The minimalist premium design stands out in any room with understated elegance. Fully developed and made in Germany, MiniVent guarantees compliance with the highest quality standards.

In addition to MiniVent, Helios offers a wide range of fans for the supply and extract ventilation of living rooms and smaller commercial spaces. The units impress with innovative design and meet the highest technical requirements.

■ Fans for wall installation, ceiling installation and window installation



Also available in version:



22^{ff}

■ Centrifugal fans with outlet connectors Ø 100 mm



32

■ Inline fans



33

■ External wall extract air fans



34^f

■ Window fans



Also available in version:



36^f

■ Ceiling fans



38

■ Heater fans



39^f

■ Controlled domestic ventilation systems

40^{ff}

M1/100



Dimensions M1/100

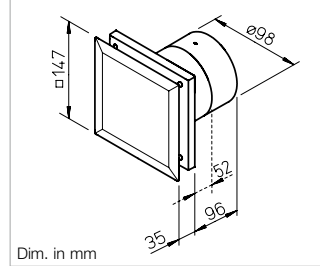

Performance curve M1/100

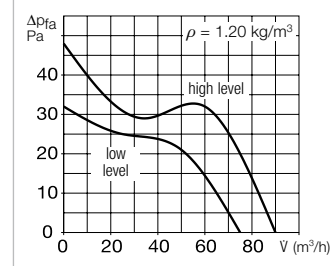

Premium class small room fans. The design and performance of the MiniVent M1/100 set new standards in the field of compact fans.

With its multi-award-winning design, the MiniVent M1/100 blends in harmoniously in all environments. The enclosed, well-designed facade completely prevents viewing of the fan clogging zone.

All M1/100 models come with 2 performance levels and tight-closing backdraught shutters as standard.

The noise level is extremely low thanks to Helios ultraSilence technology.

Available with turn-off delay mode and interval mode or barrier-free automatic functions, such as the presence detector or humidity control function. The humidity control function responds to the rate of humidity increase with intelligent electronics and effectively prevents mould formation.

Universally applicable for the ventilation of bathrooms, WCs and other small rooms.

Features

- Extremely low power consumption of just 5 Watts at $V = 75 \text{ m}^3/\text{h}$.
- Ultra quiet thanks to ultraSilence technology; just 25 dB(A) at $V = 75 \text{ m}^3/\text{h}$.
- Pressure performance: $60 \text{ m}^3/\text{h}$ volume flow at 31 Pa resistance. $90 \text{ m}^3/\text{h}$ free blowing, ΔP max. 45 Pa.
- In case of restricted space conditions, the M1/100 guide wheel can be easily removed. This reduces the installation depth from 96 to just 52 mm.
- Compact dimensions for universal flush-mounted installation in walls, shafts and ceilings with NW 100.
- All parts are made of high-quality plastic, colour: white.
- Ball bearings and motor are designed for continuous loads, constant output and lifelong functional reliability.
- Motor with thermal overload protection, maintenance-free and radio interference-free.
- Applicable in wet room zone 1 according to DIN VDE 0100-701.
- Electrical supply line can be surface or flush-mounted.
- Practical quick installation due to screwless connection terminals.

Type	M1/100	M1/100/N/C	M1/100 F	M1/100 P
Ref. no.	06171	06172	06175	06174
Version	Standard model with two speed levels	Like M1/100, with codeable turn-off delay & interval model ¹⁾	Like M1/100, with humidity control function ^{1) 4)}	Like M1/100, with presence detector ¹⁾
Turn-off delay time, min. optional at high or low level	—	6, 10, 15, 21 adjustable	6, 12, 18, 24 adjustable ³⁾	6
Interval mode, hours optional at high or low level	—	0, 8, 12, 24 adjustable	—	—
Start-up delay approx. sec.	—	0, 45, 90, 120	0 or 45 ³⁾	—
Inner shutter, removable	Yes	Yes	Yes	Yes
Flow rate free blowing m^3/h	90 / 75	90 / 75	90 / 75	90 / 75
Impeller \varnothing mm	92	92	92	92
Speed min^{-1}	2650 / 2250	2650 / 2250	2650 / 2250	2650 / 2250
Voltage / Frequency 50 Hz	230 V	230 V	230 V	230 V
Power consumption W	9 / 5	9 / 5	9 / 5	9 / 5
Rated current A	0.06 / 0.04	0.06 / 0.04	0.06 / 0.04	0.06 / 0.04
Sound pressure level dB(A) at 3 m ²⁾	30 / 25	30 / 25	30 / 25	30 / 25
Wiring diagram no.	915	917	919	918
Electrical supply line NYM-O in mm ²	3 x 1.5	4 x 1.5	4 x 1.5	3 x 1.5
Protection class II, protection category	IP45	IP45	IP45	IP45
Max. air flow temperature	+40 °C	+40 °C	+40 °C	+40 °C
Weight approx. kg	0.80	0.80	0.80	0.80

¹⁾ All electronic functions optionally adjustable at high or low performance level.

²⁾ Free field conditions.

³⁾ For manual operation.

⁴⁾ Limit value 60, 70, 80, 90 % adjustable.

Beautiful and clean

Air flows into the M1 from all sides. The front facade is completely closed and elegantly conceals the bothersome clogging zone in conventional compact fans.

The M1 blends in harmoniously in all environments. The smooth-surfaced front facade always remains easy to maintain and clean.

Intelligent humidity control function

The humidity control function of type M1/100 F automatically activates the fan depending on the humidity increase rate. The turn-off delay time depends on the room humidity reduction. In case of constantly high humidity, the fan will automatically switch to interval mode.



Rapid connection

The electrical connection is enormously facilitated by a generously dimensioned, circumferential cable storage space on the back of the unit, the full rotatability of the casing and screwless terminals.

Long-life ball bearings for 40.000 operating hours allow installation in any position, even directly in the ceiling.

Flexible installation depth

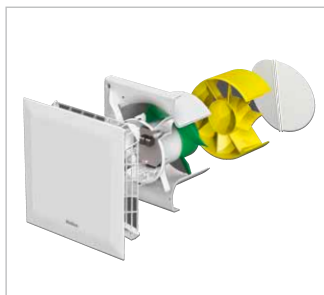
The removeable guide wheel reduces the installation depth from 96 to 52 mm. Installation possible with or without backdraught shutters.

Applicable in wet room zone 1

MiniVent M1/100 complies with jet water protection IPX5, insulation protection class II and may be used in zone 1 according to DIN VDE 0100-701.

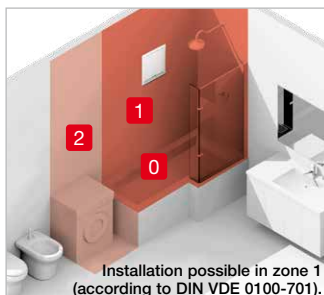
Wall mounting kit
WES 100 Ref. no. 00717

Two telescoping plastic ducts serve as the wall/feed duct; for flush-mounted installation.

External wall connection possible in two ways:

- Frame with three blades as an automatic shutter.
- Use of the frame with fixed grille. All parts made of high-quality plastic.

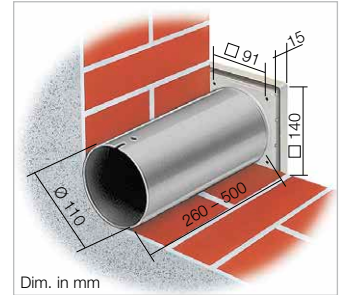

Dim. in mm

Telescopic wall sleeve
TWH 100 Ref. no. 06352

Like WES, but without shutter and grille.

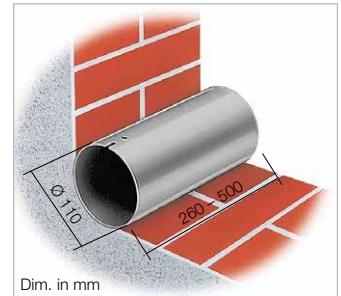

Dim. in mm

Operating and speed switch
0-1-2 for standard model
MVB Ref. no. 06091

With functions On/Off, low and high speed.

Load capacity 3 A (ind.)
 Voltage 230 V, 1~, 50/60 Hz
 Protection category IP 30
 Installation in standard flush-mounted box
 Dimensions mm W 80 x H 80 x D 15
 Weight approx. 0.1 kg

Mounting panel
MBR 90/160/300 Ref. no. 00281

Made of high-quality, impact-resistant plastic, colour: alpine white. Ideal for use in renovations.

All M1/100 models can be easily installed in existing, rectangular shaft openings with the mounting panel.

The panel can be fully painted or wallpapered in order to hide it.

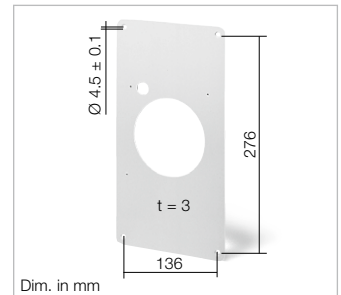

Dim. in mm

Mounting flange
MF 100 Ref. no. 06188

For installation depth reduction in case of thin walls, narrow shafts and short bends. Also suitable for the installation of a drawcord switch (accessories). If required, multiple MF 100 can be connected to each other.

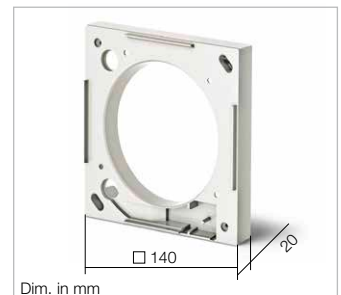

Dim. in mm

Accessory details **Page**

Flexible ventilation ducts, roof outlets and ventilation grilles	553 ff.
Intake air elements	578 ff.

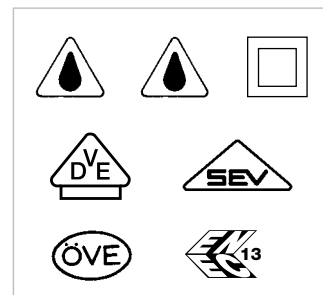

M1/120



Dimensions M1/120

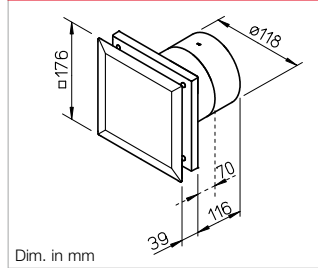

Performance curve M1/120

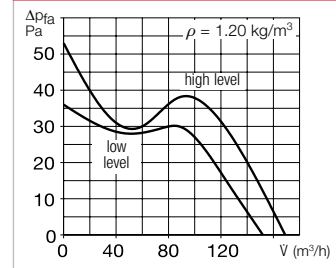

Premium class small room fans. The design and performance of the MiniVent M1/120 set new standards in the field of compact fans.

With its multi-award-winning design, the MiniVent M1/120 blends in harmoniously in all environments. The enclosed, well-designed facade completely prevents viewing of the fan clogging zone.

All M1/120 models come with 2 performance levels and tight-closing backdraught shutters as standard.

The noise level is extremely low thanks to Helios ultraSilence technology.

Available with turn-off delay mode and interval mode or barrier-free automatic functions, such as the presence detector or humidity control function. The humidity control function responds to the rate of humidity increase with intelligent electronics and effectively prevents mould formation.

Universally applicable for the ventilation of small to medium-sized rooms in private, commercial and industrial buildings.

Features

- Extremely low power consumption of just 10 Watts at $V = 150 \text{ m}^3/\text{h}$.
- Ultra quiet thanks to ultraSilence technology; just 32 dB(A) at $V = 150 \text{ m}^3/\text{h}$.
- Pressure performance: $120 \text{ m}^3/\text{h}$ volume flow at 31 Pa resistance. $170 \text{ m}^3/\text{h}$ free blowing, ΔP max. 53 Pa.
- In case of restricted space conditions, the M1/120 guide wheel can be easily removed. This reduces the installation depth from 116 to just 70 mm.
- Compact dimensions for universal flush-mounted installation in walls, shafts and ceilings with NW 120/125.
- All parts are made of high-quality plastic, colour: white.
- Ball bearings and motor are designed for continuous loads, constant output and lifelong functional reliability.
- Motor with thermal overload protection, maintenance-free and radio interference-free.
- Applicable in wet room zone 1 according to DIN VDE 0100-701.
- Electrical supply line can be surface or flush-mounted.
- Practical quick installation due to screwless connection terminals.

Type	M1/120	M1/120/N/C	M1/120 F	M1/120 P
Ref. no.	06360	06361	06364	06363
Version	Standard model with two speed levels	Like M1/120, with codeable turn-off delay & interval model ¹⁾	Like M1/120, with humidity control function ^{1) 4)}	Like M1/120, with presence detector ¹⁾
Turn-off delay time, min. optional at high or low level	—	6, 10, 15, 21 adjustable	6, 12, 18, 24 adjustable ³⁾	6
Interval mode, hours optional at high or low level	—	0, 8, 12, 24 adjustable	—	—
Start-up delay approx. sec.	—	0, 45, 90, 120	0 or 45 ³⁾	—
Inner shutter, removable	Yes	Yes	Yes	Yes
Flow rate free blowing m^3/h	170 / 150	170 / 150	170 / 150	170 / 150
Impeller Ø mm	111	111	111	111
Speed min^{-1}	2350 / 2050	2350 / 2050	2350 / 2050	2350 / 2050
Voltage / Frequency 50 Hz	230 V	230 V	230 V	230 V
Power consumption W	13 / 10	13 / 10	13 / 10	13 / 10
Rated current A	0.09 / 0.08	0.09 / 0.08	0.09 / 0.08	0.09 / 0.08
Sound pressure level dB(A) at 3 m^2	36 / 32	36 / 32	36 / 32	36 / 32
Wiring diagram no.	915	917	919	918
Electrical supply line NYM-O in mm^2	3 x 1.5	4 x 1.5	4 x 1.5	3 x 1.5
Protection class II, protection category	IP45	IP45	IP45	IP45
Max. air flow temperature	+40 °C	+40 °C	+40 °C	+40 °C
Weight approx. kg	1.05	1.05	1.05	1.05

¹⁾ All electronic functions optionally adjustable at high or low performance level.

²⁾ Free field conditions.

³⁾ For manual operation.

⁴⁾ Limit value 60, 70, 80, 90% adjustable.

Beautiful and clean

Air flows into the M1 from all sides. The front facade is completely closed and elegantly conceals the bothersome clogging zone in conventional compact fans.

The M1 blends in harmoniously in all environments. The smooth-surfaced front facade always remains easy to maintain and clean.



Intelligent humidity control function

The humidity control function of type M1/120 F automatically activates the fan depending on the humidity increase rate. The turn-off delay time depends on the room humidity reduction. In case of constantly high humidity, the fan will automatically switch to interval mode.



Rapid connection

The electrical connection is enormously facilitated by a generously dimensioned, circumferential cable storage space on the back of the unit, the full rotatability of the casing and screwless terminals.

Long-life ball bearings for 40.000 operating hours allow installation in any position, even directly in the ceiling.



Wall mounting kit

WES 120 Ref. no. 00486

Two telescoping plastic ducts serve as the wall/feed duct. The external wall connection is carried out by using the frame with blades as an automatic shutter.

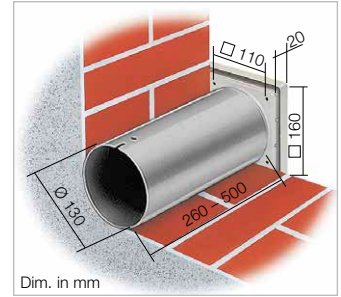

Dim. in mm

Telescopic wall sleeve

TWH 120 Ref. no. 06353

Like WES, but without shutter.

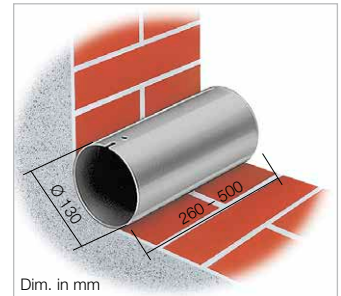

Dim. in mm

Operating and speed switch 0-1-2 for standard model

MVB Ref. no. 06091

With functions On/Off, low and high speed.

Load capacity 3 A (ind.)

Voltage 230 V, 1~, 50/60 Hz

Protection category IP 30

Installation in standard flush-mounted box

Dimensions mm W 80 x H 80 x D 15

Weight approx. 0.1 kg



Accessory details Page

Flexible ventilation ducts, roof outlets and ventilation grilles	553 ff.
Intake air elements	578 ff.

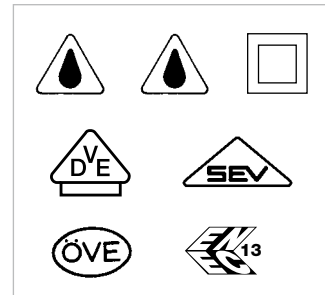

Flexible installation depth

The removeable guide wheel reduces the installation depth from 116 to 70 mm. Installation possible with or without back-draught shutters.

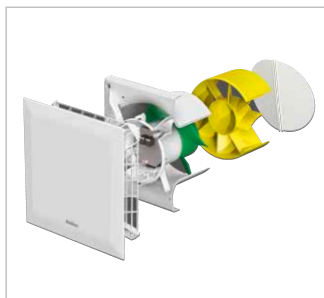

Applicable in wet room zone 1

MiniVent M1/120 complies with jet water protection IPX5, insulation protection class II and may be used in zone 1 according to DIN VDE 0100-701.

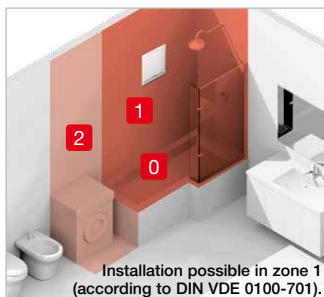

Installation possible in zone 1 (according to DIN VDE 0100-701).

M1/150



Dimensions M1/150

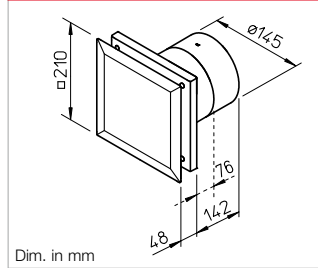

Performance curve M1/150

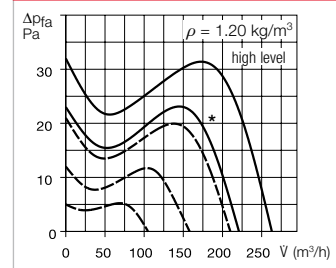

* low level
--- Example performance levels of 0-10 V type with continuously variable control

Premium class small room fans. The design and performance of the MiniVent M1/150 set new standards in the field of compact fans. With its multi-award-winning design, the M1/150 blends in harmoniously in all environments. The enclosed, well-designed facade completely prevents viewing of the fan clogging zone. All M1/150 models come with high efficiency EC drive technology, with 2 performance levels or continuously variable and tight-closing back-draught shutters as standard. The noise level is extremely low thanks to Helios ultraSilence technology. Available with turn-off delay mode and interval mode, continuously variable speed control or barrier-free automatic functions, such as the humidity control function. The humidity control function responds to the

rate of humidity increase with intelligent electronics and effectively prevents mould formation. Universally applicable for the ventilation of medium-sized rooms in private, commercial and industrial buildings.

■ Features

- Extremely low power consumption of just 6 Watts at $\dot{V} = 220 \text{ m}^3/\text{h}$.
- Ultra quiet thanks to ultraSilence technology; just 35 dB(A) at $\dot{V} = 220 \text{ m}^3/\text{h}$.
- Pressure performance: 180 m^3/h volume flow at 31 Pa resistance. 260 m^3/h free blowing, ΔP max. 33 Pa.
- In case of restricted space conditions, the M1/150 guide wheel can be easily removed. This reduces the installation depth from 142 to just 76 mm.

- Compact dimensions for universal flush-mounted installation in walls, shafts and ceilings with NW 150/160
- All parts are made of high-quality plastic, colour: white.
- Ball bearings and motor are designed for continuous loads, constant output and lifelong functional reliability.
- Motor with thermal overload protection, maintenance-free and radio interference-free.
- Applicable in wet room zone 1 according to DIN VDE 0100-701.
- Electrical supply line can be surface or flush-mounted.
- Practical quick installation due to screwless connection terminals.
- The 0-10 V type offers a wide range of applications in combination with CO₂, VOC or temperature sensors. The min./max. speed is fully adjustable and

continuously variable control via potentiometer is also possible. Control takes place via three level switches or continuously variably via universal control systems or electronic differential pressure/temperature controllers. A potential-free relay outlet is available as standard for the connection of an electrical shut-

Type	M1/150	M1/150/N/C	M1/150 F	M1/150 0-10 V
Ref. no.	06041	06042	06043	06044
Version	Standard model with two speed levels	Like M1/150, with codeable turn-off delay & interval model ¹⁾	Like M1/150, with humidity control function ¹⁾⁴⁾	Continuously variable control
Turn-off delay time, min., optional at high, low or both levels	—	6, 10, 15, 21 adjustable	6, 12, 18, 24 adjustable ³⁾	6
Interval mode, hours, optional at high, low or both levels	—	0, 8, 12, 24 adjustable	—	—
Start-up delay approx. sec.	—	0, 45, 90, 120	0, 45, 90, 120 ³⁾	—
Inner shutter, removable	Yes	Yes	Yes	Yes
Flow rate free blowing m^3/h	260 / 220	260 / 220	260 / 220	260-50
Impeller Ø mm	137	137	137	137
Speed min^{-1}	1900 / 1600	1900 / 1600	1900 / 1600	1900 -980
Voltage / Frequency 50 Hz	230 V	230 V	230 V	230 V
Power consumption W	8 / 4.5	8 / 5	9 / 6	9 / min. 3.5
Rated current A	0.08 / 0.06	0.10 / 0.09	0.08 / 0.06	0.08 / 0.035
Sound pressure level dB(A) at 3 m ²⁾	39 / 35	39 / 35	39 / 35	max. 39
Wiring diagram no.	1080	1081	1082	1083
Electrical supply line NYM-O in mm ²	3 x 1.5	4 x 1.5	4 x 1.5	2 x 1.5 ⁵⁾
Protection class II, protection category	IP45	IP45	IP45	IP45
Max. air flow temperature	+40 °C	+40 °C	+40 °C	+40 °C
Weight approx. kg	1.20	1.20	1.20	1.20

¹⁾ All codeable times and electronic functions optionally adjustable at high, low or both performance levels. ²⁾ Free field conditions. ³⁾ For manual operation. ⁴⁾ Limit values from 40-90 % continuously variably adjustable. ⁵⁾ Additional connection cable provided for relay output.

Beautiful and clean

Air flows into the M1 from all sides. The front facade is completely closed and elegantly conceals the bothersome clogging zone in conventional compact fans.

The M1 blends in harmoniously in all environments. The smooth-surfaced front facade always remains easy to maintain and clean.

Intelligent humidity control function

The humidity control function of type M1/150 F automatically activates the fan depending on the humidity increase rate. The turn-off delay time depends on the room humidity reduction. In case of constantly high humidity, the fan will automatically switch to interval mode.



Rapid connection

The electrical connection is enormously facilitated by a generously dimensioned, circumferential cable storage space on the back of the unit, the full rotatability of the casing and screwless terminals.

Long-life ball bearings for 40.000 operating hours allow installation in any position, even directly in the ceiling.

Flexible installation depth

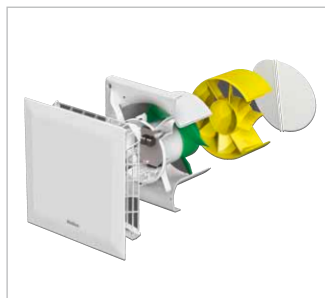
The removeable guide wheel reduces the installation depth from 142 to 76 mm. Installation possible with or without back-draught shutters.

Applicable in wet room zone 1

MiniVent M1/150 complies with jet water protection IPX5, insulation protection class II and may be used in zone 1 according to DIN VDE 0100-701.



Wall mounting kit

WES 150 Ref. no. 00537

Two telescoping plastic ducts serve as the wall/feed duct; for flush-mounted installation.

External wall connection possible in two ways:

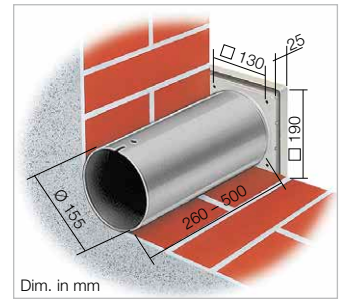
- Frame with three blades as an automatic shutter.
- Use of the frame with fixed grille. All parts made of high-quality plastic.

Telescopic wall sleeve

TWH 150 Ref. no. 06354

Like WES, but without shutter and grille.

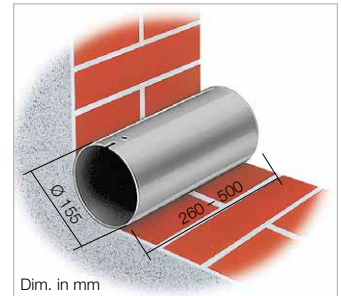
Operating and speed switch 0-1-2 for standard model

MVB Ref. no. 06091

With functions On/Off, low and high speed.

Load capacity 3 A (ind.)
 Voltage 230 V, 1~, 50/60 Hz
 Protection category IP 30
 Installation in standard flush-mounted box
 Dimensions mm W 80 x H 80 x D 15
 Weight approx. 0.1 kg

Speed switch for M1/150 N/C and M1/150 F

DSEL 2 Ref. no. 01306

With functions On/Off, low and high speed.

Load capacity 3 A (ind.)
 Voltage 230 V, 1~, 50/60 Hz
 Protection category IP 30
 Installation in standard flush-mounted box
 Dimensions mm W 80 x H 80 x D 15
 Weight approx. 0.1 kg

Speed potentiometer for M1/150 0-10 V

With functions On/Off, continuously variable speed control.

PU 10 Ref. no. 01734
 For flush-mounted installation.

Installation in standard flush-mounted box
 Dim. mm W 80 x H 80 x D 21 protr.

PA 10 Ref. no. 01735
 For surface-mounted installation.

Casing Surface installation
 Dimensions mm W 80 x H 80 x D 65

Accessory details Page

Flexible ventilation ducts, roof outlets and ventilation grilles	553 ff.
Intake air elements	578 ff.
Universal control system, Speed potentiometer	605 ff.

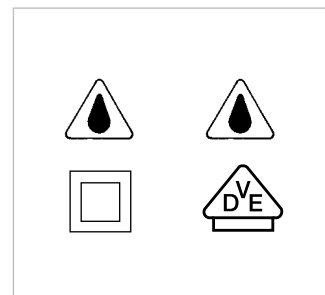

HR 90 KE



Dimensions HR 90 KE

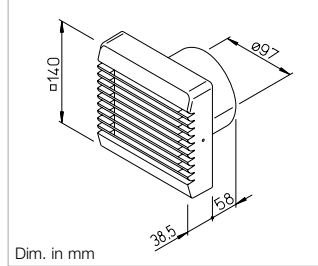

Performance curve HR 90 KE

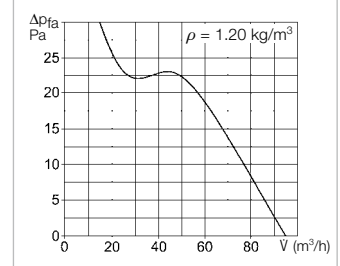

High-quality mini fans with electrical inner shutter.

The shutter blades behind the facade open and close completely silently and automatically when the fan is activated/deactivated. This ensures a rattle-free intake air connection when the fan is at a standstill. The design with long-life ball bearings ensures maintenance-free operation, low-noise running and it allows installation in any position.

Designed to be unobtrusive, the HR 90 KE fits in any room environment. The upward facing blades prevent viewing of the fan clogging zone. Universally applicable for the ventilation of bathrooms, WCs and other small rooms.

■ Highlights

- Smooth running and functionally reliable, even in continuous operation.
- Maintenance, relubrication and cleaning are unnecessary. The ball bearings have a lubricant supply which is adequate for their entire service life of approx. 30.000 operating hours.
- The noise-tested long-life ball bearings guarantee lifelong smooth running without any disturbing squeaking, even under the most difficult operating conditions.
- The ball bearings and motor are designed for continuous loads, constant output and lifelong functional reliability.

- Applicable in wet room zone 1 according to DIN VDE 0100-701.
- Flush-mounted installation in Rohre und Schächte mit NW 100.
- Applicable practically anywhere due to short installation depth and small dimensions.
- Attractive softline design in pleasant white.
- All casing parts made of high-quality plastic.
- Contact protection according to DIN EN ISO 13857.
- Motor with thermal overload protection, maintenance-free and radio interference-free, for continuous operation.
- Electrical supply line can be surface or flush-mounted.
- Practical quick installation due to screwless terminals for electrical connection.
- Plug claw connection for insertion in ducts 100 mm or screw fastening in larger openings.

Type	HR 90 KE	HR 90 KEZ
Ref. no.	00334	00335
Built-in turn-off delay switch ¹⁾ , Turn-off delay time approx. 2-8 min.	—	Yes ²⁾
Electrical inner shutter	Yes	Yes
Flow rate free blowing m ³ /h ³⁾	95	95
Impeller Ø mm	93	93
Speed min ⁻¹	2550	2550
Voltage / Frequency 50/60 Hz	230 V	230 V
Power consumption W	17	20
Rated current A	0.12	0.14
Sound pressure level dB(A) at 1 m	44	44
Wiring diagram no.	483	484
Protection class II, protection category	IP45	IP45
Max. air flow temperature	+40 °C	+40 °C
Weight approx. kg	0.60	0.62

¹⁾ Initiates start-up delay of approx. 1 min.

²⁾ NYM-O 3 x 1.5 mm² required. ³⁾ Calculated with outlet side duct, length 2 x D.

■ Reference

HR 90 K 12 V –
with safety extra-low voltage
upon request

■ **Mini fans HR 90 KE especially for ceiling installation**

Ball bearing mounted fans are best suited for vertical installation in the ceiling. The mounting flange MF 90 (accessories) prevents the ingress of condensate into the fans from vertical pipes.



■ **Screwless installation**

HR 90 KE have screwless terminals for electrical connection. The facade can be quickly attached due to a snap-in mechanism. Side spring clips facilitate installation in ducts with NW 100.



■ **Applicable in wet room zone 1**

The HR 90 KE models comply with protection category IP X5 (jet water protection) and may be used in zone 1 according to DIN VDE 0100-701.

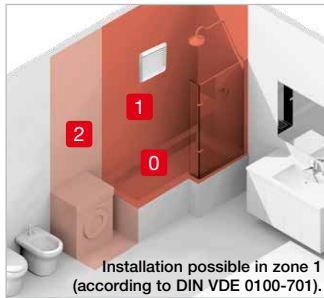

■ **Installation in any position**

HR 90 KE is equipped with electrical inner shutter and high-quality long-life ball bearings as standard. This allows wall and ceiling installation in any position – vertical, horizontal or diagonal.

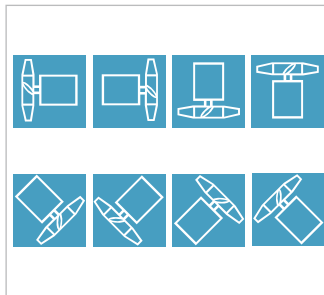

■ **Test marks**

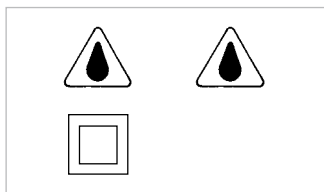

Wall mounting kit

WES 90 Ref. no. 00717

Two telescoping plastic ducts serve as the wall/feed duct; for flush-mounted installation. External wall connection possible in two ways:
a) Frame with three blades as an automatic shutter.
b) Use of the frame with fixed grille. All parts made of high-quality plastic.

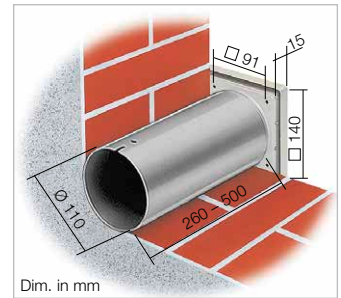

Telescopic wall sleeve

TWH 90 Ref. no. 06352

Like WES, but without shutter and grille.

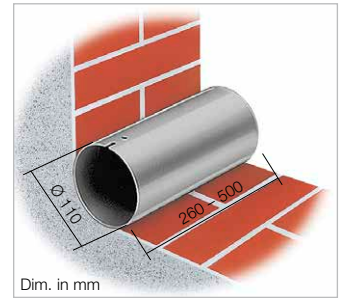

Window mounting kit

FES 90 Ref. no. 00462

For the installation of HR 90 KE models in single and double glazed windows, thin walls and panels. Possible pane / wall thickness 1 to 40 mm. External cover with flat rain-repellent grille just 29 mm thick. Drawcord operation. Protection category IP20.

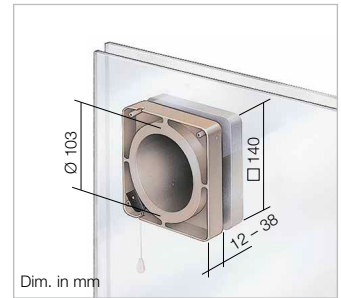

Mounting panel

MBR 90/160/300 Ref. no. 00281

Made of high-quality, impact-resistant plastic, colour: alpine white. Ideal for use in renovations. HR 90 KE models can be easily installed in existing, rectangular shaft openings with the mounting panel. The panel can be fully painted or wallpapered in order to hide it.

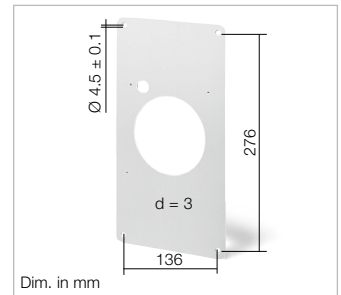

Mounting flange

MF 90 Ref. no. 00819

Areas of application:
1. Required for ceiling installation. MF prevents the ingress of condensate into the fan from vertical extract air ducts.
2. For the simple installation of connection cables in case of an inconvenient wall outlet, because the fan is raised from the wall by 23 mm.
3. For the simple installation of the fan in narrow shafts. In case of 90° bend with a short duct connection, the MF reduces the installation depth of the fan.
4. In case of installation in thin walls, the installation depth of the fan can be reduced as follows: To 35 mm with 1 mounting flange. To 7 mm with 2 mounting flanges. Colour: Alpine white.

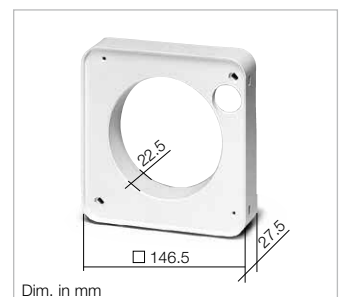

■ **Accessory details Page**

Flexible ventilation ducts, roof outlets and ventilation grilles	553 ff.
Intake air elements	578 ff.
Speed controllers, controllers & turn-off delay switches	591 ff.

HVR 150



Dimensions HVR 150

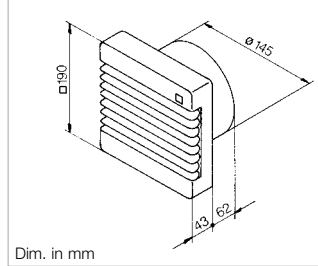

Performance curve HVR 150

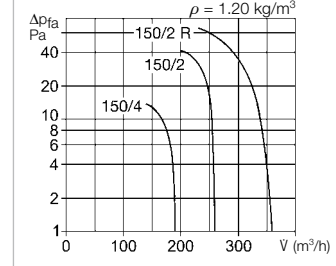

HelioVent wall and window fans are suitable for the ventilation of small to medium-sized rooms in private, commercial and industrial buildings.

The standard equipment with ball bearings guarantees:

- Installation in any position.
- Smooth running and functional reliability in continuous operation.
- Quiet and maintenance-free operation over the entire service life.

Features

- Ventilation grille can be removed without tools and easily cleaned in a water bath.
- Low installation depth prevents potential installation problems.
- Versatile installation in walls, ceilings or shafts in any position.
- Flow rate adjustment through continuously variable, electronic speed control.
- Motor protection through integrated thermal contacts.

Description

The unit blends in harmoniously in all room environments. All parts, including the fan casing and impeller, made of high-quality plastic. Facade: white. Visual operation indicator through built-in indicator lights. High pressure and volume performance due to 8-bladed high performance impeller and an additional inlet guide wheel.

Enclosed motor with low-noise ball bearings for continuous operation. Installation possible in any position. Maintenance-free and radio interference-free. Contact protection according to DIN EN ISO 13857. Electrical supply line can be surface or flush-mounted.

Window mounting kit

FES 150 Ref. no. 00463

For the installation of all models, preferably types with electrical inner shutter, for single and double glazed windows, thin walls and panels. Protection category IP20. External cover with flat rain-repellent grille with fixed blades. Operation via supplied drawcord or remote on-site switch.

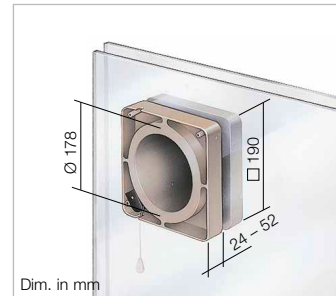

Wall mounting kit

WES 150 Ref. no. 00537

For flush-mounted wall installation; consisting of: Two wall telescoping plastic ducts and the external wall connection. This can be installed as an automatic shutter or with a rain-repellent grille for HVR E models. Both elements are included in delivery.

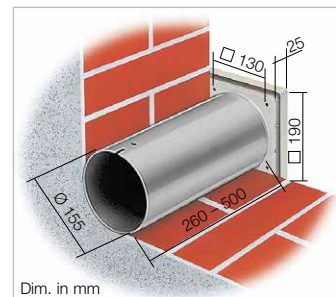

Telescopic wall sleeve

TWH 150 Ref. no. 06354

Like WES, but without shutter and grille.

Accessory details Page

Roof outlets and ventilation grilles	553 ff.
Intake air elements	578 ff.
Speed controllers, controllers & turn-off delay switches	591 ff.

Type	HVR 150/4 E	HVR 150/2 E	HVR 150/2 RE
Ref. no.	00283	00285	00286
Electrical inner shutter	Yes	Yes	Yes
Reversible (supply and extract ventilation)	—	—	DSEL 2¹⁾ Ref. no. 01306
Flow rate free blowing m ³ /h	180	260	360
Impeller Ø mm	140	140	140
Speed min ⁻¹ ca.	1300	1800	2600
Voltage / Frequency	230 V~ / 50 Hz	230 V~ / 50 Hz	230 V~ / 50 Hz
Power consumption W	30	35	50
Rated current A	0.20	0.15	0.25
Sound pressure level dB(A) at 1 m	46	58	64
Wiring diagram no.	283	283	284.1
Protection class II, protection category	IP44	IP44	IP44
Max. air flow temperature	+40 °C	+40 °C	+40 °C
Weight approx. kg	1.2	1.4	1.5

¹⁾ NYM-O 3 x 1.5 mm² required for reverse operation.

HV 200 / HV 250



Dimensions HV 200 / HV 250

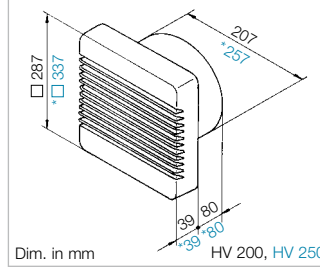

Charac. curve HV 200 / HV 250

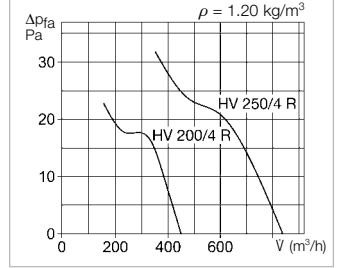

HelioVent wall fans fit in every room atmosphere thanks to their timeless design:
In living rooms and dining rooms, offices and conference rooms, restaurants or foyers.

Universally applicable. For supply and extract ventilation (reversible). Installation in walls or ceilings, even in an inclined position.

■ HelioVent at a glance

- Compact, low-noise fan unit with clever design features:
- HelioVent fits in unobtrusively in all environments.
- No view of the contaminated fan openings.
- High performance and low air noise due to low flow resistances.
- Ideal for maintenance. Facade can be removed with one hand. Easy to clean in a water bath.

■ Installation – connection

Installation is very easy and completed in minutes. The electrical connection is convenient. Reliable plug-in terminals and large cable storage space simplify the process. The supply line can be flush-mounted or surface-mounted.

■ Speed control

Possible in the range from 0–100 % using voltage reduction via electronic or transformer control units.

■ Description

- Room-side facade and fan casing made from high-quality and impact-resistant plastic in alpine white.
- Powerful capacitor motor with high level of efficiency. Fully enclosed. Corrosion-proof in die-cast aluminium casing, protected against dust and water (protection category IP54). Winding with humidity protection through bath impregnation in ISO class B.
- Protected against overloading by built-in thermal contact (automatically reactivating).
- Noise-tested ball bearings ensure quiet running.
- The large terminal box (protection category IP55) and huge cable storage space facilitate connection work.
- Profiled high-performance impeller with high efficiency ensures low-noise operation.
- Radio interference-free and maintenance-free.
- Contact protection according to DIN EN ISO 13857 guaranteed by room-side facade.
- Service and connection-friendly.

■ Accessory details Page

Roof outlets and ventilation grilles	553 ff.
Intake air elements	578 ff.
Speed controllers, controllers & turn-off delay switches	591 ff.

Installation in wall or ceiling

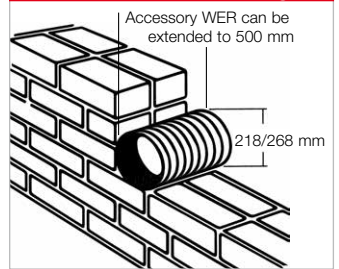

Installation in thin panels

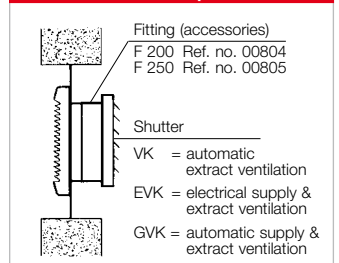

Type	HV 200/4 R	HV 250/4 R
Ref. no.	00957	00958
Reversible (supply and extract ventilation)	Yes	Yes
Flow rate free blowing m³/h	450	840
Impeller Ø mm	200	250
Speed min⁻¹	1360	1380
Voltage / Frequency	230 V~ / 50 Hz	230 V~ / 50 Hz
Power consumption W	30	40
Rated current A	0.13	0.20
Sound pressure level dB(A) at 15 Pa at 1 m distance (free field conditions)	52	55
Sound power dB(A)	60	63
Wiring diagram no.	439	439
Protection category	IP54	IP54
Max. air flow temperature	+40 °C	+40 °C
Weight approx. kg	2.1	2.6

Accessories Description	Fan type	HV 200	HV 250
Feed duct for flush-mounted wall installation	Type Ref. no.	WER 200 00368	WER 250/225 00369
Shutter for extract air operation	Type Ref. no.	VK 200 00758	VK 250 00759
Shutter for supply and extract ventilation	Type Ref. no.	GVK 200 00370	GVK 250 00371
Reversing switch for supply and extract ventilation	Type Ref. no.	DSEL 2 1) 01306	DSEL 2 1) 01306
Reversing switch with speed controller continuously variable	Type Ref. no.	BSK 00240	BSK 00240
Speed controller flush-mounted	Type Ref. no.	ESU 1 00236	ESU 1 00236
Speed controller surface-mounted	Type Ref. no.	ESA 1 00238	ESA 1 00238

1) NYM-J 4 x 1.5 mm² required for reverse operation.

DX 200



Dimensions DX 200

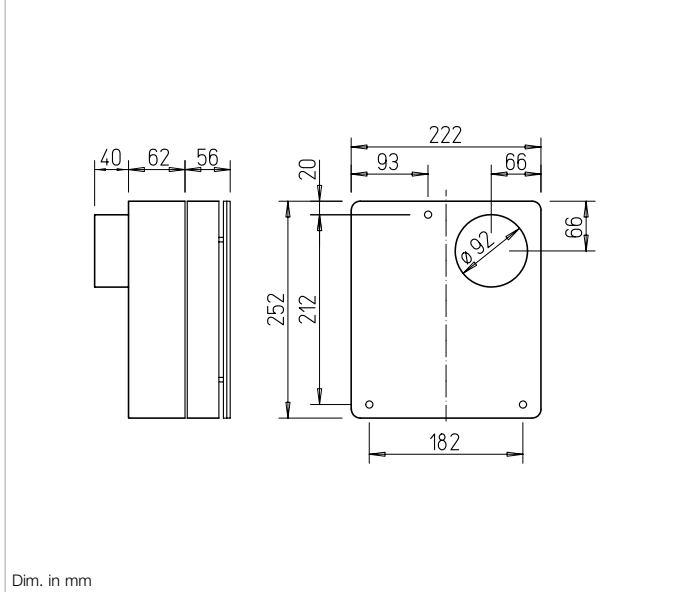

The universal series DX is characterised by attractive design and a hidden inlet opening. The unit is powerful, easy to install and suitable for the extract ventilation of small rooms in private, commercial and industrial buildings.

Description

- The convenient function control for various operating modes allows individual adjustment to room conditions and user requirements.
- Easy wall installation; can also be flush-mounted by removing the rear casing frame.
- Air outlet connectors can be inserted into ducts NW 100.
- The facade is easily removeable without tools for cleaning and maintenance.
- With integrated backdraught shutter.
- Maintenance-free motor with thermal overload protection.

Performance curves DX 200

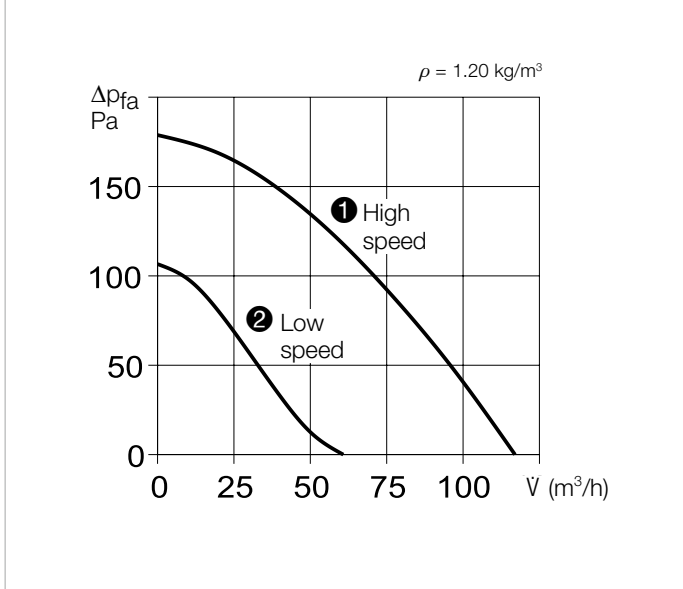

Technical data	
Type	DX 200
Ref. no.	01703
Operating mode	Continuously variable with electronic controller ESU 1 / ESA 1, Ref. no. 00236 / 00238. Two speed levels available using operating switch MVB, Ref. no. 06091.
Flow rate at level free blowing m³/h ¹⁾	① 120 ② 60
Speed min ⁻¹	2660
Voltage / Frequency	230 V~ / 50 Hz
Power consumption W	33
Rated current A	0.24
Sound pressure level dB(A) at 1 m ¹⁾	55 42
Wiring diagram no.	693.1
Protection category	IPX5
Max. air flow temperature	+40 °C
Weight approx. kg	1.7

Accessory details	Page
Flexible ventilation ducts, wall outlets and ventilation grilles	553 ff.
Intake air elements	578 ff.
Speed controllers, controllers & turn-off delay switches	591 ff.

¹⁾ Values refer to the different performance levels.

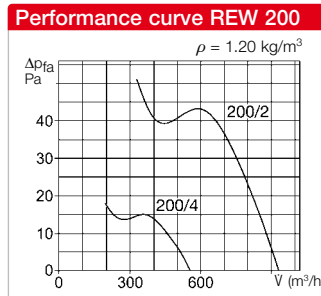
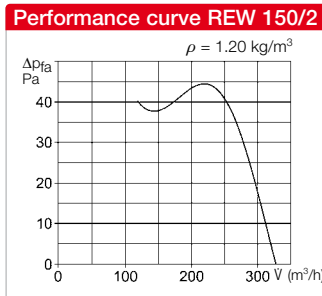
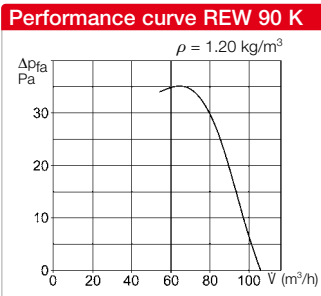
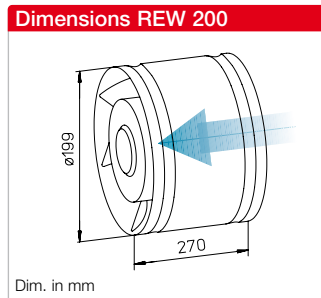
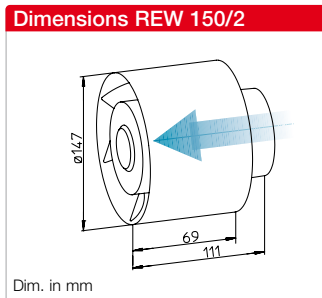
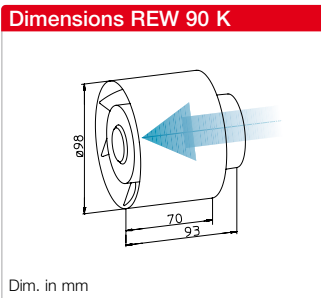

Description REW 90 K

Suitable for insertion in ducts with NW 100. Casing made of high-quality, impact-resistant plastic with integrated guide apparatus. Profiled high-performance impeller with 5 blades made of plastic. Motor with thermal overload protection for continuous operation with maintenance-free, lifetime lubricated ball bearings. Terminal box at rear of the motor for electrical connection.

Description REW 150/2

Suitable for insertion in ducts with NW 150. Casing made of high-quality, impact-resistant plastic with integrated guide apparatus. Profiled high-performance impeller with 8 blades made of plastic. Motor with thermal overload protection for continuous operation with maintenance-free, lifetime lubricated ball bearings, reversible, for continuous operation. Terminal box at rear of the motor for electrical connection.

Description REW 200

Suitable for insertion in ducts with NW 200. Casing with two outward-facing reinforcing beads made of galvanised steel sheet. Profiled impeller with 7 blades made of plastic. Enclosed motor with thermal overload protection for continuous operation and die-cast aluminium casing. Tropicalised winding with humidity protection. Ball bearing mounted, maintenance and radio interference-free; reversible. Term. box on motor.

■ **Use options**

Versatile axial fans for delivering small to medium volume flows against low resistances. Unit can be used for room ventilation, air circulation, cooling, drying, etc.

■ **Installation**

Unit can be installed in any position. The flow direction depends on the installation position. Suitable for insertion or interpositioning in pipes. In this context, note possible pressure performance and resistances. In case of higher resistances, use centrifugal inline fans. Electrical connection at rear of the motor. During installation makes sure that the fan remains accessible for inspection.

■ **Accessories**

Speed controller with reverser
(for REW 150 and 200)
BSX Ref. no. 00240

■ **Accessory details Page**

Flexible ventilation ducts, roof outlets and ventilation grilles	553 ff.
Extract, supply, intake air elements and disc valves	566 ff.
Speed controllers, controllers & turn-off delay switches	591 ff.

Type	REW 90 K	REW 150/2	REW 200/4	REW 200/2
Ref. no.	00441	00440	07504	07505
Reversible (supply and extract ventilation)	No	DSEL 2 ¹⁾ No. 01306	DSEL 2 ²⁾ No. 01306	DSEL 2 ²⁾ No. 01306
Flow rate free blowing m³/h	105	330	550	930
Impeller Ø mm	93	140	200	200
Speed min ⁻¹	2320	2100	1350	2280
Voltage / Frequency	230 V~ / 50 Hz	230 V~ / 50 Hz	230 V~ / 50 Hz	230 V~ / 50 Hz
Power consumption W	15	29	40	70
Rated current A	0.10	0.13	0.28	0.33
Sound pressure level dB(A) at 1 m	45	56	44	57
Wiring diagram no.	479	478	439	439
Protection category	IP55	IP44	IP54	IP54
Max. air flow temperature	+40 °C	+40 °C	+50 °C	+50 °C
Weight approx. kg	0.46	1.1	2.0	2.5

¹⁾ NYM-O 3 x 1.5 mm² required for reverse operation.

²⁾ NYM-J 4 x 1.5 mm² required for reverse operation.

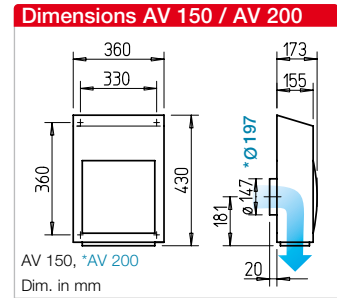
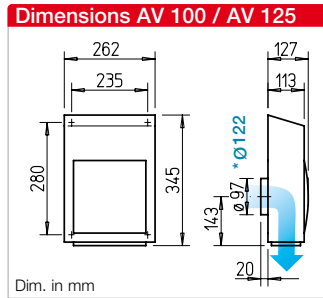

Application

Designed for external wall installation for the ventilation of all small and medium-sized rooms. Suitable for a number of applications in residential, commercial and industrial buildings.

Powerful, efficient centrifugal fans allow the connection of duct systems and overcome resistances from filters and system components. The unit is the ideal solution for the extract ventilation of domestic kitchens because the annoying noises from extraction hoods are minimised. This also applies for other applications and the connection of duct systems because the fan noise moves outside. Ideal for retrofitting in renovations and conversions.

Special features

- No disturbing fan noises inside the rooms due to external wall installation.
- Easy and cost-effective installation through anchoring of the operational unit.
- Weatherproof casing. Tight-closing shutter blades with spring return.
- Connectors according to standard duct Ø for connection to wall duct or duct system.
- Solid base plate made of plastic also allows installation on uneven surfaces.
- Electrical supply line can be flush-mounted from behind or surface-mounted from the side.
- Casing**
 - Waterproof cover hood made of galvanised steel sheet, powder-coated, alpine white.
 - Outlet-side bird protection grille and two shutter blades with spring return.

Power control

All models come with three power levels as standard. Continuously variable with electronic controllers or 5 step transformers.

Drive

Enclosed, ball bearing mounted motor with humidity protection, insulation class F, for continuous operation, maintenance-free and radio interference-free.

Motor protection

Motor protected by thermal overload protection in the winding.

Impeller

Energy-efficient centrifugal impeller with backward curved blading made of plastic, dynamically balanced.

Note

The fan may only be commissioned if impeller contact protection according to DIN EN ISO 13857 is provided.

Noise

The total level and range for the sound power level are specified above the performance diagram. The sound pressure at 3 m (free field conditions) is also specified in the type table.

Reference	Page
Speed controllers, controllers & turn-off delay switches	591 ff.

Type	Ref. no.	Connection Ø	Max. flow rate	Max. speed	Max. sound press. level case-radiated	Voltage 50 Hz	Max. power consumption	Max. current consumption	Wiring diagram	Max. air flow temperature	Weight net approx.	Transformer speed controller 5-step	Type	Ref. no.
		mm	ṽ m³/h	min ⁻¹	dB(A) at 3 m	Volt	W	A	No.	+ °C	kg			
AV 100	02654	100	310/150/70	2710/2050/1190	46/38/26	230	55/28/13	0.24/0.13/0.05	1386	60	4.6		TSW 1.5	01495
AV 125	02655	125	360/170/80	2471/1510/930	45/38/25	230	54/26/13	0.24/0.12/0.06	1386	60	4.6		TSW 1.5	01495
AV 150	02656	150	620/330/210	2520/1520/1070	50/43/33	230	100/57/40	0.44/0.25/0.18	1386	55	8.3		TSW 1.5	01495
AV 200	02657	200	680/350/240	2530/1970/1450	51/37/35	230	100/53/40	0.44/0.23/0.18	1386	55	8.3		TSW 1.5	01495

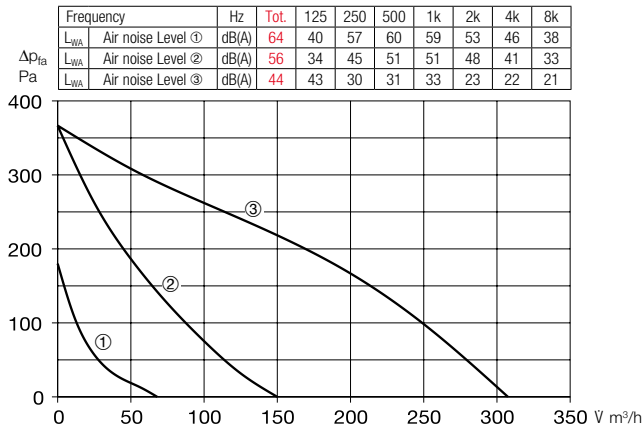
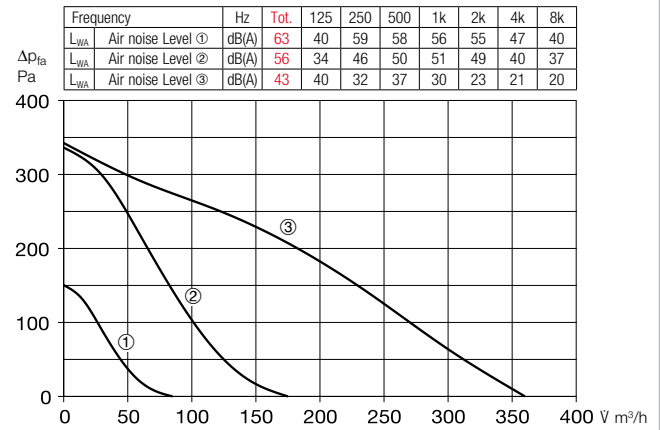
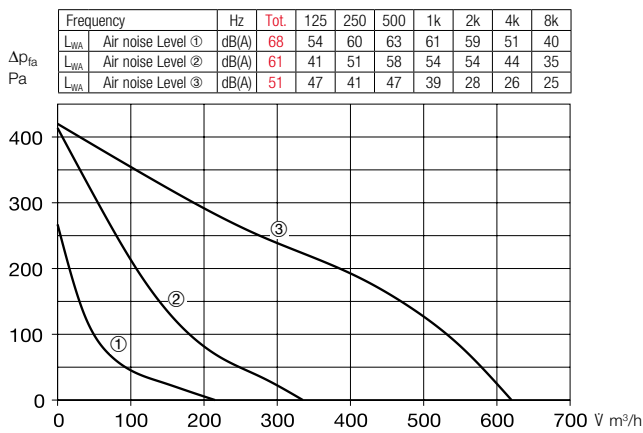
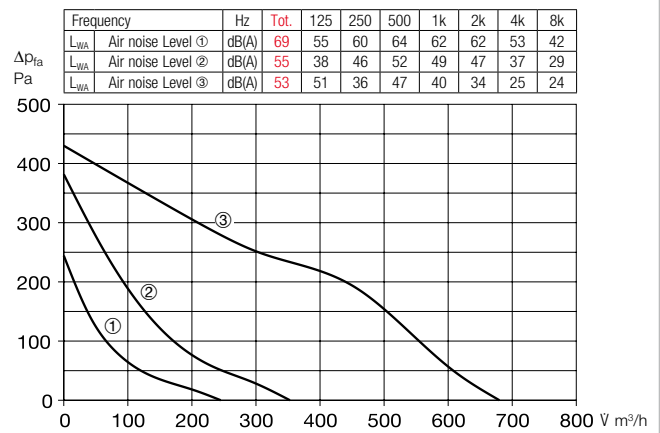
Performance curve AV 100

Performance curve AV 125

Performance curve AV 150

Performance curve AV 200

Accessories

Transformer speed controller TSW 1.5 Ref. no. 01495
Five-step, for surface installation.
1~ alternating current, 230 V.
Max. load 1.5 A
Wiring diagram no. 437.1
Dim. mm W 154 x H 200 x D 79



Three-step speed and operating switch with 0 position DSZ Ref. no. 01598
Convenient flush-mounted speed switch for fans with three performance levels. Room light cannot be switched in parallel. Can be used with central ventilation box ZEB EC.
Load capacity AC 3 / 2.2 kW, AC 15 / 6 A
Protection category IP 20
Install. in flush-m. box w/ 55 mm depth
Wiring diagram no. 735
Dimensions mm W 80 x H 80 x D 23



Electronic speed controller ESU 1 Ref. no. 00236
For flush-mounted installation.
Front and rotary knob made of white plastic. Installation in standard flush-mounted box. Operation indicator via light ring.
Max. load 1 A.
Minimum load 0.15 A
Protection category (built-in) IP30
Wiring diagram no. 556.1
Dim. mm W 80 x H 80 x D 21 protr.



Electronic speed controller ESA 1 Ref. no. 00238
For surface installation.
White plastic casing, operation indicator via light ring in rotary knob.
Max. load 1 A.
Minimum load 0.15 A
Protection category IP40
Wiring diagram no. 556.1
Dimensions mm W 80 x H 80 x D 65



Electronic speed controller, contin. variable flush / surface-mounted		Speed controller, 3-step flush-mounted	
Type	Ref. no.	Type	Ref. no.
ESU 1/ESA 1	00236/00238	DSZ	01598
ESU 1/ESA 1	00236/00238	DSZ	01598
ESU 1/ESA 1	00236/00238	DSZ	01598
ESU 1/ESA 1	00236/00238	DSZ	01598

HR 90 KE/FES



HVR 150/FES



Dimensions HR 90 KE/FES

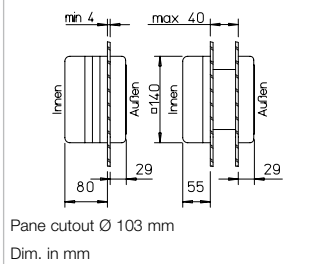

Dimensions HVR 150/FES

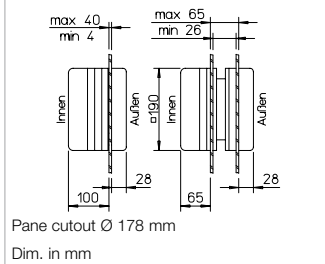

Elegant compact window fans with flow rates of 80–360 m³/h.

- **Area of application**
All rooms and windows in private buildings as well as small to medium-sized commercial spaces.

Special features and common features

- **Universal application**
Prepared for installation in panels, single glazed windows, double glazed windows and composite windows (HR 90 KE/FES not for hinged composite window) as standard. Suitable for wall installation with anchoring using wall sleeve (accessories).

- **Electrical inner shutter**
Tight-closing with silent operation; maintenance-free. Automatic operation with the fan circuit.
- **Casing**
Casing made of high-quality, impact-resistant plastic. Fan casing and external grille in white.
- **Motor**
Enclosed motor in splash-proof casing. Maintenance-free and radio interference-free. Maximum air flow temp. +40 °C.
- **Installation**
The service-friendly and installation-friendly unit design allows quick installation with only a few steps.

Description HR 90 KE/FES

- Compact window fan for rooms of any kind. Upward facing blades prevent viewing of the fan clogging zone.
- Applicable in single and double glazed windowpanes with a thickness of 4–40 mm. The variable distance compensation is achieved by using or omitting the supplied spacer frames.
- External cover with flat rain-repellent grille.
- Operation via on-site On/Off switch or the built-in drawcord.
- Integrated operation indicator.

Description HVR 150/FES

- Powerful window fans for small to medium-sized private and commercial spaces.
- For installation in single and double glazed windows (composite window can be opened unhindered) as well as thin panels with a thickness of 4–40 mm. Variable distance compensation through installation or omission of the supplied spacer frames.
- External cover with flat rain-repellent grille.
- Operation via on-site On/Off switch or the built-in drawcord.
- Optical operation indicator.

Reference	Page
Speed controllers, controllers & turn-off delay switches	591 ff.

Product range			
Technical data	HR 90 KE/FES	HVR 150/2 E/FES	HVR 150/2 RE/FES
Ref. no.	00334 / 00462	00285 / 00463	00286 / 00463
Electrical inner shutter	Available	Available	Available
Reversible (supply and extract ventilation)	Extract ventilation	Extract ventilation	DSEL 2 ²⁾ Ref. no. 01306
Pane cutout Ø mm	103 mm	178 mm	178 mm
Flow rate free blowing m³/h	80	260	360
Impeller Ø mm	93 mm	140 mm	140 mm
Voltage 230 V, 50 Hz, power consumption W	17	35	50
Rated current A	0.12	0.15	0.25
Speed min ⁻¹	2550	1800	2600
Sound pressure ¹⁾ /power dB(A)	44/51	58/65	64/71
Weight approx. kg	1.0	1.9	2.0
Wiring diagram no.	483	283	284
Protection category	IP45	IP44	IP44
Accessories			
Double glazed window installation for hinged composite window	—	Available	Available
Ref. no.	—	—	—
Wall installation, Telescopic wall sleeve 260 – 500 mm	TWH 90	TWH 150	TWH 150
Ref. no.	06352	06354	06354
Speed controller flush/surface-mounted	—	ESU 1 / ESA 1	ESU 1 / ESA 1
Ref. no.	—	00236 / 00238	00236 / 00238
Speed controller with reversing switch for switching from supply to extract ventilation	—	—	BSX
Ref. no.	—	—	00240

¹⁾ Distance at 1 m free field conditions. ²⁾ NYM-O 3 x 1.5 mm² required for reverse operation.

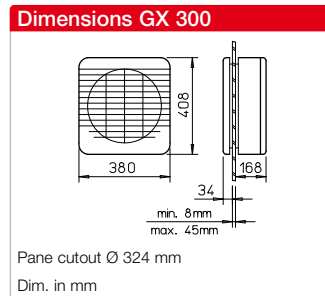
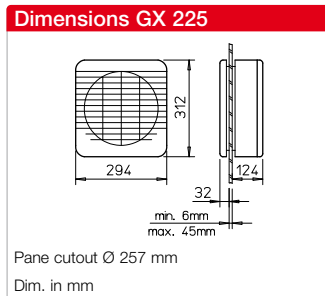
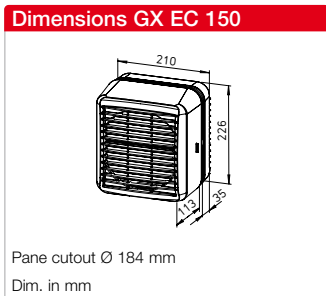

Low-noise window fans for use in private, commercial and industrial buildings. The series GX offers smooth running and functional reliability in continuous operation. The fan and external grille come in pleasant white. Attractive design, integrates unobtrusively in all rooms and any building facade.

- **Area of application**
For the ventilation of medium and large rooms of any kind in the temperature range from -30 °C to +40 °C.

Special features

- **Universal application**
Prepared for installation in single glazed windows, double glazed windows and panels as standard. Suitable accessories available for composite windows and wall installation.
- **Electrical connection**
Concealed behind elegant inner facade. Tight-closing and silent function. The shutter has a lo-

cked position which allows permanent opening when the fan is deactivated (static ventilation in summer). The automatic shutter function is forced and time-delayed with the fan circuit.

- **Casing**
Attractive design made of high-quality, impact-resistant plastic. Colour: white. Inner facade can be removed with one hand and without tools for cleaning in a water bath (power supply is then automatically interrupted).
- **Motor**
Enclosed, splash-proof motor (IP44) with thermal overload protection. GX EC 150 with energy-saving EC motor. Maintenance-free and radio interference-free. Maximum air flow temperature +40 °C. Power can be controlled via speed controller (accessories) depending on type.

- **Installation**
The service-friendly and installation-friendly unit design allows quick installation with only a few steps.

Product range			
Technical data	GX EC 150	GX 225	GX 300
Ref. no.	09367	01484	01485
Electrical inner shutter	Available	Available	Available
Reversible (supply & extr. ventilation)	Not available	Available	Available
Pane cutout Ø mm	184 mm	257 mm	324 mm
Flow rate free blowing m ³ /h	230	670	1650
Impeller Ø mm	150	225	300
Power consumption Watts	10	45	125
Voltage, 50 Hz (GX EC 150 - 50/60 Hz)	230 V	230 V	230 V
Rated current A	0.06	0.3	0.7
Speed min ⁻¹	1480	1250	1250
Sound pressure ¹⁾ /power dB(A)	44/52	54/61	61/68
Weight approx. kg	1.4	4.0	7.0
Wiring diagram no.	1385	538	538

¹⁾ at 1 m free field conditions. ²⁾ with reversing switch. ³⁾ with two speeds and reversing switch.

- operating modes without changing the wiring:
- Extract ventilation
 - Supply ventilation or
 - Reversing operation by means of external operating switch/speed controller (accessories).
 - Static ventilation possible (without fan operation) by locking the shutter.
 - Control via on-site On/Off switch or operating switch/speed controller (accessories). Automatic shutter function with fan circuit.
 - Flat rain grille does not obstruct venetian blinds or roller shutters.
 - Installation-friendly design, all main parts can be removed for cleaning without tools.

Description GX 300

- Powerful fan in comfort class for the supply and extract ventilation of larger rooms in attractive softline design. Blends in harmoniously in all environments and building facades.
- Internal operating mode switch allows the following without changing the wiring:
 - Extract ventilation
 - Supply ventilation or
 - Reversing operation by means of external operating switch/speed controller (accessories).
- Control via on-site On/Off switch or operating switch/speed controller (accessories). Automatic shutter function with fan circuit.
- Static ventilation, installation and external cover see GX 225.
- Installation-friendly design, room-side casing parts can be removed for cleaning without tools.

Description GX EC 150

- Sophisticated fan in a lower performance class for extract ventilation.
- Installation in single glazed and double glazed windows as well as fixed and hinged composite windows using accessories.
- Flat, external rain-repellent grille does not obstruct venetian blinds or roller shutters.
- Service-friendly and installation-friendly. Room-side casing parts can be removed for cleaning without tools.
- Shutter function can be switched to static ventilation (without fan operation).
- Energy-saving EC-Motor in protection category IP54 with maximum efficiency level.

Description GX 225

- Fan in medium performance class offering high convenience and integrated function switch which enables the following

Reference Page

Speed controllers, controllers & turn-off delay switches	591 ff.
--	---------

Accessories Window fan			
Type	GX EC 150	GX 225	GX 300
Double glazed window mounting kit			
for closed panes	DR 150 ⁴⁾	DR 225 ⁴⁾	DR 300 ⁴⁾
Ref. no.	05114	05115	05116
Wall installation			
with screw fastening, 50 cm long	SB 50/2	SB 50/3	SB 50/4
Ref. no.	01385	01386	01387
with feed duct	KR 150 ⁵⁾	WER 225/250 ⁶⁾	WER 300 ⁷⁾
Ref. no.	05091	00369	00469
Elec. speed controller flush/surface	—	ESU 1/ESA 1	ESU 1/ESA 1
Ref. no.	—	00236/00238	00236/00238
Elec. speed controller ²⁾ surface-m.	—	BSX	BSX
Ref. no.	—	00240	00240
Operating switch ²⁾ flush-mounted	—	DSEL 2	DSEL 2
Ref. no.	—	01306	0130
Operating switch ³⁾ surface-mounted	—	FR 22/30	FR 22/30
Ref. no.	—	00998	00998

⁴⁾ Spacer rings for underpinning from 2–35 mm (1 set = 10 pcs).
⁵⁾ 330 mm long. ⁶⁾ 170 – 500 mm long. ⁷⁾ 170 – 450 mm long.

DVW 90



DVAW 130



DVW 140



DVAM 130



For cooling in summer and energy conservation during winter. For a wide range of applications, e.g. air circulation, cooling and energy conservation in medium and large rooms such as foyers and waiting halls, restaurants, clubs, boutiques and sales-rooms, production halls, warehouses, tennis halls and sports halls as well as the acceleration of drying processes in industrial buildings.

Ceiling fans are traditionally used for cooling air in the summer. They also solve acute room air problems in sales rooms, restaurants and many other communal areas with conditions such as windowless room areas or high heat from lighting. Decorative reproductions in the "Casablanca" design also make Helios ceiling fans an attractive design element for many rooms.

The energy-saving use of ceiling fans is recommended during heating periods. Draught-free and even room heat distribution is achieved by slowly rotating ceiling fans in rooms with

high ceilings such as sports halls, tennis halls, industrial halls and warehouses. This results in an approx. 25% temperature increase at floor level without additional heating costs. In this respect, the energy expenditure for the ceiling fans is negligibly small. Pilot installations which have been running over a number of years achieved an average temperature increase of 4 K at floor level.

Ceiling fans series DVW

- Robust metal version in classic design.
- Enclosed motor, maintenance-free and radio interference-free.
- Vibration-damping suspension for low-vibration running.
- Fall protection with arrester cable according to DIN EN 60335-2-80.
- Simple installation with pre-assembled delivery. Only the impeller blades need to be screwed on.
- Variable suspension height through delivery of a short and a long pendent tube.
- Speed-controllable with 5-step speed controller TSW 0.3 (accessories).

- Reversible air flow direction. The flow direction can be set to the floor or to the ceiling by fixed connection or using a reversing switch (accessories DSEL 2). Minimum starting voltage of 100 V required for reverse operation (upward air flow direction).

Ceiling fan series DVA

- Fan comes in typical "Casablanca" design for use for decorative purposes.
- Casing in antique brass or antique white finish. Five wooden blades with stained walnut or antique white cane work. Maintenance-free motor with covered cooling slots, ball bearing mounted, for continuous operation.
- Vibration-damping suspension for low-vibration running.
- Simple installation directly to the ceiling or short pendent tube (included in delivery).
- Pull switch for three performance levels and On/Off below the motor. A remote speed controller (accessories) can be connected.

Fan selection

The impeller diameter, positioning and suspension height of the ceiling fans are the parameters for even and extensive air flow in the room. The room height minus the pendent length provides the suspension height. Based on this height and the impeller Ø, the adjacent diagram shows the area affected by the air flow in m². The distance from the centre of the fan to the walls should be approx. 3 times the impeller Ø. The distance from the centre of a fan to the centre of another fan (when using multiple ceiling fans) should be approx. 6 times the impeller Ø. Operation at high speed is recommended in summer for cooling and operation at low speed is recommended in winter for energy conservation.

Important installation information

Accident prevention regulations (UVV) stipulate a minimum distance of 2.3 m from the floor to the lower wing edge.

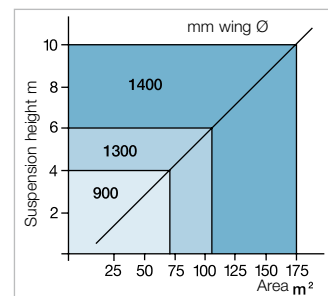

Accessories for DVW and DVA

Speed controller TSW 0.3 Ref. no. 03608
Five-step speed controller with On/Off switch for surface installation.

Energy-saving automatic control unit EDTW Ref. no. 01613
For fully automated differential temperature-dependent speed control, especially for the winter operation of ceiling fans.

Technical data – Order data				
Type	DVW 90	DVW 140	DVAW 130	DVAM 130
Ref. no.	08648	08649	08650	08651
Wing Ø mm	900	1400	1300	1300
Number of blades	3	3	5	5
Voltage / Frequency	1~, 230 V / 50 Hz	1~, 230 V / 50 Hz	1~, 230 V / 50 Hz	1~, 230 V / 50 Hz
Current consumption A	0.26	0.30	0.29	0.29
Power consumption W	50	75	66	66
Maximum speed min ⁻¹	340	270	220	220
Suspension height min./max. mm	440/565	460/585	220/360/510	220/360/510
Sound pressure dB(A) at 4 m	35	44	29	29
Weight approx. kg	4.8	6.8	6.7	6.7

STH



Dimensions STH 3

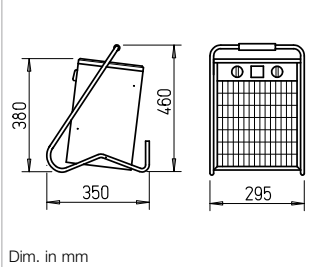

Dim. in mm

Dimensions STH 5

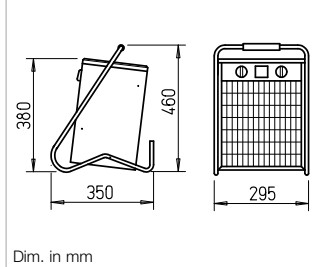

Dim. in mm

Dimensions STH 9 T

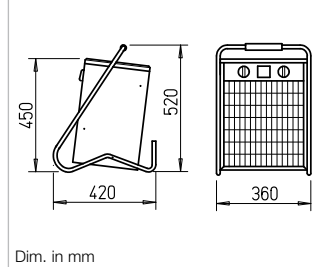

Dim. in mm

Dimensions STH 15 T

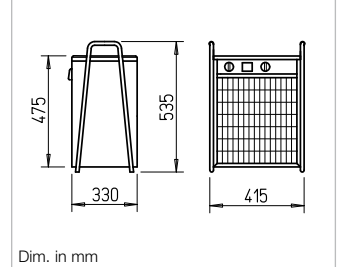

Dim. in mm

The compact, powerful STH heater fans are reliable, robust and convenient in terms of equipment. They are suitable for heating and drying. Use on construction sites, in production facilities, warehouses and workshops, churches, meeting rooms, etc.

- Series with heat output of 3 kW: 1~, 230 V as well as 5, 9 and 15 kW: 3~, 400 V.
- Practical operation due to compact dimensions.
- Attractive design.
- Easy to lift and transport due to ergonomically designed, solid transport hanger.

■ Quality in every detail

- Robust, hard-wearing and secure due to metal body. Suitable for use under hard conditions, even in wet rooms and for continuous operation.
- Corrosion-resistant casing, made entirely of galvanised steel sheet, powder-coated in pleasant white.
- Protective stand with powder coating in red.
- Robust front protection grille, powder-coated in hard-wearing grey.
- Clear control panel, protected against damage due to recessed mounting.
- Maintenance-free and radio

interference-free.

- All models in protection category IPX4. Applicable in wet rooms.
- Contact protection according to DIN EN 60335.
- Enclosed sheathed heating element made of stainless steel with low surface temperature.
- Easily accessible, externally resettable protection against overheating for types STH 9 T and STH 15 T. Automatically reactivating after cooling for STH 3 and STH 5.
- Individual time setting
All types from 9 kW are equipped with a timer for preprogrammed activation for

up to 24 hours under specification of the room temperature as standard.

■ Control

- Control via built-in operating switch.
- Heating for types with 3, 5 and 9 kW switchable in two levels; switchable in three levels for type with 15 kW.
- Heating operation can be controlled via built-in room air thermostat with setting range +5 °C to +35 °C. Fan remains in operation for better heat distribution in the room when the heating is deactivated.

Technical data

Type	STH 3	STH 5	STH 9 T	STH 15 T
Ref. no.	02520	02521	02522	02523
Heat output kW	3.0	5.0	9.0	15.0
Switchable heat output kW	0 – 1.5 – 3	0 – 2.5 – 5	0 – 4.5 – 9	0 – 5 – 10 – 15
Max. temperature increase K	25	37	38	35
Max. ambient temperature °C	40	40	40	40
Flow rate m ³ /h	400	400	700	1300
Speed min ⁻¹	1300	1300	1300	1300
Sound pressure dB(A) at 4 m (free field cond.)	40	40	43	58
Voltage V, 50 Hz	1~, 230	3~, 400	3~, 400	3~, 400
Rated current A	13.5	7.5	13.5	21.7
Req. socket / CEE coupling	¹⁾	16 A	16 A	32 A
Weight approx. kg	6.0	6.0	10.5	15.5
Timer function (pre-programming 24 h)	—	—	Yes	Yes

¹⁾ with approx. 1.5 m long cable and Schuko plug.