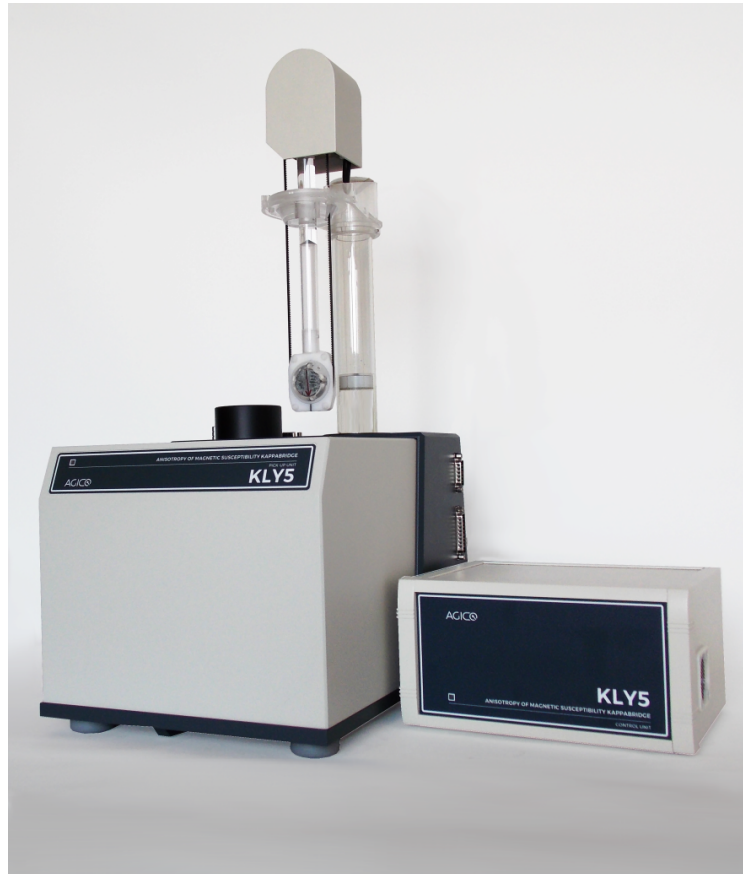


# KLY5-A / KLY5-B

KAPPBRIDGES FOR MEASUREMENTS OF IN-PHASE  
AND OUT-OF-PHASE MAGNETIC SUSCEPTIBILITY



User Manual

Version 1.0.1  
September 2022





## Contents

<b>1</b>	<b>KLY5-A, B Introduction</b>	<b>1</b>
1.1	Main Features . . . . .	1
1.2	Measuring Principle . . . . .	1
1.3	Technical Specifications . . . . .	3
1.4	Specimens to be measured . . . . .	4
<b>2</b>	<b>KLY5 accessories and attachments</b>	<b>5</b>
2.1	Standard set of accessories . . . . .	5
2.2	Spare parts and accessories . . . . .	6
2.3	3D Rotator . . . . .	8
2.4	CS4 – High Temperature Furnace Apparatus . . . . .	9
2.5	CS-L – Low Temperature Cryostat Apparatus . . . . .	10
<b>3</b>	<b>Installation Procedures</b>	<b>11</b>
3.1	Choosing the Place . . . . .	11
3.2	Interconnection of Units . . . . .	12
3.3	Main Switch and Main Fuse . . . . .	14
3.4	Testing the Magnetic Environment . . . . .	15
<b>4</b>	<b>Measurements</b>	<b>17</b>
4.1	Operation basics . . . . .	17
4.1.1	Switching ON and OFF the instrument . . . . .	17
4.1.2	Measurements with manual holders . . . . .	17
4.1.3	Measurements with rotators . . . . .	20
4.2	Calibration . . . . .	22
4.2.1	Calibration with manual holder . . . . .	22
4.2.2	Calibration with rotators . . . . .	23
4.3	Holder Correction . . . . .	23
4.3.1	Holder Correction of the manual holders . . . . .	23
4.3.2	Holder Correction of the rotators . . . . .	24
<b>5</b>	<b>Troubleshooting and Maintenance</b>	<b>25</b>
5.1	Troubleshooting . . . . .	25
5.1.1	Hardware Error Indications . . . . .	25
5.1.2	Software Error Messages . . . . .	26
5.2	Maintenance . . . . .	27
5.2.1	Cleaning the Holders and Rotator . . . . .	27

---










5.2.2	Cleaning the Classic Rotator and Belt . . . . .	27
5.2.3	Cleaning of 3D Rotator . . . . .	30
5.2.4	Cleaning of Up/Down Mechanism . . . . .	34
<b>6</b>	<b>Appendix</b>	<b>37</b>
6.1	Specimen coordinate system . . . . .	37
6.2	List of Magnetic Anisotropy Factors . . . . .	37
6.3	Orientation parameters . . . . .	39
6.4	EC Declaration of Conformity . . . . .	40
6.5	Warranty . . . . .	42












## General Safety Instructions

Before beginning of work with the instrument review the following safety precautions to avoid injury and prevent damage to this product or any products connected to it.

**Service procedures should be performed by qualified personnel only!**

-  **Do Not Operate Without Covers!** To avoid electric shock or fire hazard, do not operate this product with covers or panels removed.
-  **Do Not Operate in Wet or Damp Conditions!** To avoid electric shock, do not operate this product in wet or damp conditions.
-  **Do Not Operate in an Explosive Atmosphere!** To avoid injury or fire hazard, do not operate this product in an explosive atmosphere.
-  **Do Not Disconnect Connectors!** To avoid damage of the instrument never disconnect any connector while the device is ON.
-  **Do Not Operate With Suspected Failures!** If you suspect there is damage to this product, have it inspected by qualified service personnel.
-  **Ground The Instrument!** The instrument is grounded through the Protective Earth lead of the power cord. To avoid electric shock, it is essential to connect the earth terminal of power cord to the Protective Earth terminal before any inputs or outputs.
-  **Do Not Insert Anything into the Holes of Fan!** Do not insert anything into the holes of the fan to avoid damaging the instrument.
-  **Use Proper Power Cord!** To avoid fire hazard, use only the power cord specified for this product.
-  **Fasten Connectors!** Do not operate the instrument if all connectors are not properly plugged and fixed by screws.

-  **Use Proper Mains Voltage!** Do not operate this product from a power source that is outside of the specified voltage range.
-  **Use Proper Fuses Only!** Do not use fuses which are not specified by the manufacturer. If a fuse with a different characteristics or value is used, the protection is not effective.
-  **Operator's Training!** Operator should be familiar with operation of the instrument and Safety Regulations.
-  **Use Manufacturer's Cables Only!** Other devices can be connected to the instrument via the appropriate cables only.
-  **Do not drop the product and do not expose it to any major shocks!**
-  **Do not operate the product outside the power limits given in the specifications!**
-  **Keep the packaging material out of the reach of children to prevent the risk of suffocation!**
-  **The first installation and customer training is performed exclusively by the AGICO technician or by the authorized representative.**

 Unstable or highly disturbed AC power may invoke safety circuits to protect the sensitive electronic parts by switching OFF the instrument or burning inner fuses.



**Dispose of packaging material immediately according to locally applicable regulations!**

## **Storage and Transportation**

The properly wrapped instrument can be stored and transported at a temperature -20 °C to + 55 °C and relative humidity up to 80 %. The instrument must be stored at suitable place, free of dust and chemical evaporation. **Handle with care!**



## 1 KLY5-A, B Introduction

The **KLY5 Kappabridges** are probably the most sensitive commercially available laboratory instruments for measuring magnetic susceptibility and anisotropy of magnetic susceptibility (AMS). KLY5 series brings precise absolute measurement of both **in-phase** and **out-of phase** components of magnetic susceptibility and anisotropy of magnetic susceptibility.

### 1.1 Main Features

- Precise measurement of in-phase and of out-of-phase component of magnetic susceptibility.
- Measurement of in-phase and of out-of-phase anisotropy of magnetic susceptibility.
- Fully automatic measurement of AMS and field dependence of AMS, if optional 3D Rotator is used (version A).
- Automated field variation measurement (version A).
- Built-in interface for controlling the furnace CS4 and cryostat CSL (version A).
- High sensitivity  $20 \times 10^{-9}$  SI.
- Full control by computer.
- Sophisticated hardware and software diagnostics fully controlled by computer.

### 1.2 Measuring Principle

In principle the instrument represents a precise fully automatic inductive bridge equipped with automatic zeroing system and automatic compensation of the thermal drift of the bridge unbalance as well as automatic switching to appropriate measuring range.

Special diagnostics was embedded in KLY5 Kappabridges, which monitors important signals during measurement process KLY5 and also when used in conjunction with CS4 or CSL unit.

The instrument has no control knobs, it is fully operated by external computer via USB connection. The main advantage of the new models KLY5-A and KLY5-B is the precise absolute measurement of in-phase and of out-of-phase component of

magnetic susceptibility and their anisotropy. The auto-ranging and auto-zeroing works over the entire measuring range. Automatic zeroing compensates real and imaginary components, the zeroing circuits are digitally controlled by firmware. The output signal from pick-up coils is amplified, filtered and digitalized, raw data are transferred directly to the computer which controls all the instrument functions.

The **KLY5-B** version measures the AMS of a static specimen fixed in the manual holder. In the static method the specimen susceptibility is measured in 15 different orientations following rotatable design. From these values six independent components of the susceptibility tensor and statistical errors of its determination are calculated. The specimen positions are changed manually during the measurement.

The **KLY5-A** version measures the AMS of a spinning specimen fixed in the rotator. Three measurements of deviatoric susceptibility along axes x, y and z of specimen are measured with one additional bulk susceptibility measurement. These four individual measurements enables to calculate full AMS tensor including error analysis based on multivariate statistics. The static method of the measurement can be used as well.

**KLY5-A** also allows to use so called **3D Rotator** (optional accessory), which significantly reduces the measuring time of AMS and simplifies manual handling to just one insertion of the sample. Using of 3D Rotator also enables fully automatic measurement of field dependence of in-phase and out-of phase components of AMS.

All functions of **KLY5** Kappabridges, including temperature variations of magnetic susceptibility, are controlled by software **SAFYR7**. This software for MS Windows ®operating systems also performs advanced calculations of AMS tensors, field and temperature variation factors, separation of ferromagnetic and paramagnetic susceptibility (from thermomagnetic curves) and so on. **SAFYR7** also incorporates viewer of the resulting data files. Updated versions of **SAFYR7** can be downloaded from AGICO web pages [www.agico.com](http://www.agico.com) for free.

### 1.3 Technical Specifications

Operating frequency	1220 Hz
Field intensity range	5 - 750 A/m (peak)
Field homogeneity	0.2 %
Sensitivity at 400 A/m peak.	$20 \times 10^{-9}$ SI
Measuring range	up to 0.5 SI at 750 A/m up to 1 SI at 400 A/m
Accuracy within one range	$\pm 0.1\%$
Accuracy of absolute calibration	$\pm 3\%$
Absolute phase shift calibration	$\pm 0.1^\circ$
Absolute phase shift linearity	$\pm 0.2^\circ$
Pick-up coil inner diameter	43 mm
Nominal specimen volume	10 cm <sup>3</sup>
Operating temperature range	+15 to +35 °C
HF Electromagnetic Field	1 Vm <sup>-1</sup>
Intensity Resistance	
Relative humidity	max. 80 %
Power requirements	100 - 240 V, 50/60 Hz, 80 VA
Dimensions / Mass	
Control Unit	230 mm×210 mm×130 mm / 3.5 kg
Pick-up Unit	280 mm×355 mm×320 mm / 11 kg
Rotator	320 mm×70 mm×65 mm / 1 kg

## 1.4 Specimens to be measured

### **For spinning method**    **KLY5-A only**

Cylinder	regularly shaped specimens
Diameter	25.4 (+0.2, -1.5 mm)
Length	22.0 (+0.2, -1.5 mm)
Cube	20×20×20 mm (+0.5, -1.5 mm)

### **For static method**    **KLY5-A, KLY5-B**

as for spinning method plus:

Cube	23×23×23 mm
ODP type	26×25×19.5 mm
Fragments	up to 40 cm <sup>3</sup> for bulk susceptibility



Holders for specimens of slightly different size can be supplied on request.













## 2 KLY5 accessories and attachments






### 2.1 Standard set of accessories

Standard set of accessories provided together with the KLY5 is listed below.

Part	Quantity
<b>Accessories for both KLY5-A or KLY5-B</b>	
cylindrical specimen holder (diameter 25.4 mm, length 22 mm)	3
cubic specimen holder (for cubes 20x20x20 mm)	1
cubic specimen holder (for cubes 23x23x23 mm)	1
specimen holder for ODP boxes	1
vessel for fragments	2
screwdriver for rotator	2
specimen marking tool	1
plastic cylinder	1
tool for inserting plastic cylinder	1
cylindrical calibration standard	1
<b>Accessories for KLY5-A only</b>	
classical rotator	1
spare screw for fixing specimen	3
adapter for manual holders	1
adapter for cubic samples	1
screw for adapter	2
spare tooth belt	1

## 2.2 Spare parts and accessories

<p>KLY CYL26</p>		<p>Cylindrical Specimen Holder standard size specimen (diameter 25.4 mm, length 22 mm) 15 positions in static measurement mode</p>	<p>KLY CUB20</p>		<p>Cubic Specimen Holder specimen 20x20x20 mm 15 positions in static measurement mode</p>
<p>KLY CUBS23</p>		<p>Cubic Specimen Holder soft specimen in plastic box 23x23x23 mm 15 positions in static measurement mode</p>	<p>KLY ODP</p>		<p>Specimen Holder specimen in plastic box 25x25x20 mm 15 positions in static measurement mode</p>
<p>KLY VES40</p>		<p>Vessel for Specimen Fragments for use in static measurement mode</p>	<p>KLY PCY</p>		<p>Plastic Cylinder for Manual Measurement</p>
<p>KLY SCR</p>		<p>Spare Screw for Shell of Rotator</p>	<p>KLY SCRL</p>		<p>Spare Screw (longer) for Shell of Rotator for use with the KLY BXA Insert Box</p>
<p>KLY BXA</p>		<p>Insert Box for Shell of Rotator for cubic specimen 20x20x20 mm</p>	<p>KLY SCD</p>		<p>Screw Driver for Shell of Rotator Screw</p>
<p>KLY BLT</p>		<p>Belt for Rotator and/or Up-Down Mechanism</p>	<p>KLY BLT3D</p>		<p>Belt for 3D Rotator</p>

<p>KLY RTS</p> 	<p>Shell of Rotator (sample holder of KLY-3S/4S/5A or MFK1/2-A/FA rotator)</p>	<p>KLY CALIB</p>  <p>Calibration Standard size 25.4 mm in diameter, length 22 mm for KLY-2, KLY-3/3S, KLY-4/4S, MFK1/2 all model</p>
<p>KLY CIT</p> 	<p>Tool for Inserting Plastic Cylinder</p>	<p>KLY CMA</p>  <p>Marking Tool for Standard Cylindrical Specimens</p>
<p>KLY AMH</p> 	<p>Adapter for Manual Holders fixing manual holders in Up-Down Mechanism</p>	

## 2.3 3D Rotator

3D Rotator brings increased speed and better comfort of anisotropy of magnetic susceptibility measurements. The 3D Rotator rotates the specimen simultaneously about two axes with different velocities. The 2-axis rotation enables to determine 320 directional susceptibilities during a single anisotropy measurement. These directions are very well distributed on a sphere which makes the measuring design almost rotatable. The actual measurement is fully automated in such a way that, once the specimen is mounted into the rotator, it requires no additional manipulation to measure the full AMS tensor. The approximate duration of one anisotropy measurement including bulk susceptibility is 1.5 min, compared to more than 3 minutes when the classical (3-plane) rotator is used.

### Specimens to be measured

Cylinder (regularly shaped specimens)

Diameter  $25.4 \pm 1$  mm

Length  $22.0 \pm 1$  mm

### Main features

- Rapid anisotropy measurements with full auto ranging.
- One specimen is measured in less than 2 minutes.
- Specimen has to be inserted only once.
- Single manual handling minimizes specimen misorientation errors.
- Automated AMS measurement in variable fields.
- Bulk susceptibility is automatically measured right after anisotropy measurement.
- Anisotropy tensor is automatically calculated from 640 directional susceptibilities.



## 2.4 CS4 – High Temperature Furnace Apparatus

The CS4 High Temperature Furnace Apparatus is optional attachment for MFK2-FA/KLY5-A Kappabridge designed for measurement of the temperature variations of low-field magnetic susceptibility of minerals, rocks and synthetic materials in the temperature range from ambient temperature to 700°C. Measurements can be performed under the protective argon atmosphere to reduce oxidation of measured specimen.

The quasicontinuous measurement process is fully automated, being controlled by the software SAFYR. Data processing software Cureval serves for advanced analysis of thermomagnetic curves such as empty furnace measurement subtraction, Curie temperature estimation and separation of ferromagnetic and paramagnetic part of susceptibility.

### Main features

- Lowest detectable susceptibility change  $1 \times 10^{-7}$  SI.
- Measurement at high temperatures up to 700°C.
- Software controlled heating and cooling modes.
- Measurement in the air or argon atmosphere.
- 500 to 700 pairs of susceptibility and temperature measurements to define a thermomagnetic curve.

### Technical specifications

- Nominal specimen volume (powder or fragments)  $0.25 \text{ cm}^3$ .
- Inner diameter of measuring vessel 6 mm.
- Temperature range: room temperature up to 700°C.
- Accuracy of temperature determination  $\pm 2 \text{ }^\circ\text{C}$ .
- Sensitivity to susceptibility changes  $1 \times 10^{-7}$  SI.
- Power requirements 100 - 240 V, 50/60 Hz, 700 VA.

## 2.5 CS-L – Low Temperature Cryostat Apparatus

The CS-L Low Temperature Furnace Apparatus is optional attachment for MFK2-FA/KLY5-A Kappabridge designed for measurement of the temperature variation of low-field magnetic susceptibility of minerals, rocks and synthetic materials in the temperature range from -192°C to ambient temperature.

The specimen is placed in a measuring vessel which is cooled inside the cryostat by liquid nitrogen and then heated spontaneously to a given temperature. The argon gas is needed for depleting the liquid nitrogen out of cryostat.

The quasi-continuous measurement process is fully automated, being controlled by the software SAFYR. Data processing software Cureval serves for advanced analysis of thermomagnetic curves such as empty furnace measurement subtraction, Curie temperature estimation and separation of ferromagnetic and paramagnetic part of susceptibility.



CS4 system is a necessary condition for using CS-L system!

### Main features

- Lowest detectable susceptibility change  $1 \times 10^{-7}$  SI.
- Measurement at low temperatures from -192°C.
- Cooled by liquid nitrogen.
- Estimation of ratio between ferromagnetic and paramagnetic part of susceptibility.


### Technical specifications


- Nominal specimen volume (powder or fragments)  $0.25 \text{ cm}^3$ .
- Inner diameter of measuring vessel 6 mm.
- Temperature range -192°C up to 0°C.
- Accuracy of temperature determination  $\pm 2 \text{ }^\circ\text{C}$ .
- Sensitivity to susceptibility changes  $1 \times 10^{-7}$  SI.
- Power requirements 100 - 240 V, 50/60 Hz, 700 VA .


### 3 Installation Procedures


The first installation and customer training is performed exclusively by the AGICO technician or by the authorized representative. If you need later to reinstall the apparatus, due to moving the instrument to another place or any other reasons, be sure the following conditions are met to achieve guaranteed parameters.


#### 3.1 Choosing the Place


 The instrument must not be placed near sources of alternating magnetic field, e.g. big transformers, electric motors, power lines etc.

Do not place the instrument near thermal and electrical sources and keep  it away from direct sunshine. The pick-up unit must not be exposed to heat from the sun or from other sources, which would affect the precision of measurement.

 Do not place the pick-up coils near the other instruments or computer monitors.

 Do not place the instrument in a draughty room. Air conditioning may sometimes cause higher thermal drift of coils, prevent the direct air flow.

 The temperature in the room should be stable as much as possible. The temperature variation in the room should not exceed 2°C per hour.

 Place the instrument and pick-up unit on a wooden table with good stability which has no iron part under the working desk.


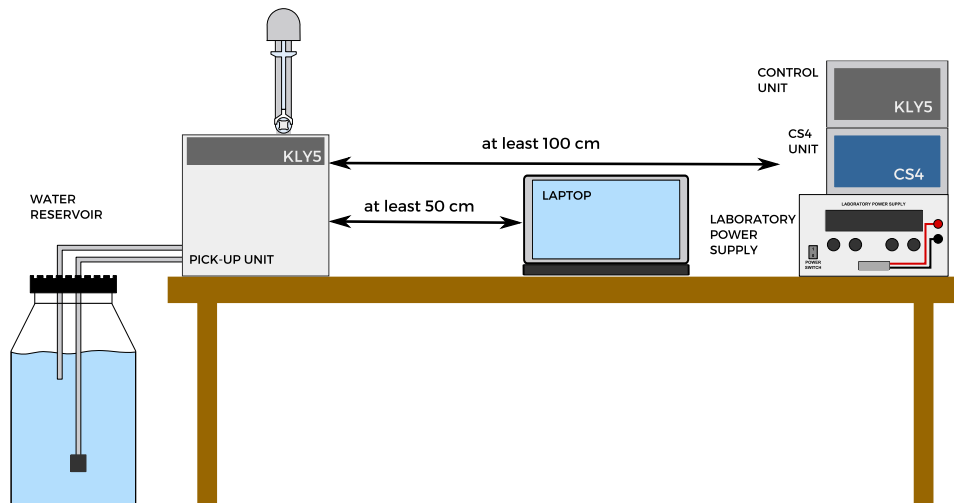
 During the measurement prevent the motion of the magnetic objects (metal parts of chairs, doors, furniture, watches, rings, tools, components of your clothes, etc.)

 Fig.1 shows recommended layout of KLY5/CS4 apparatuses parts.

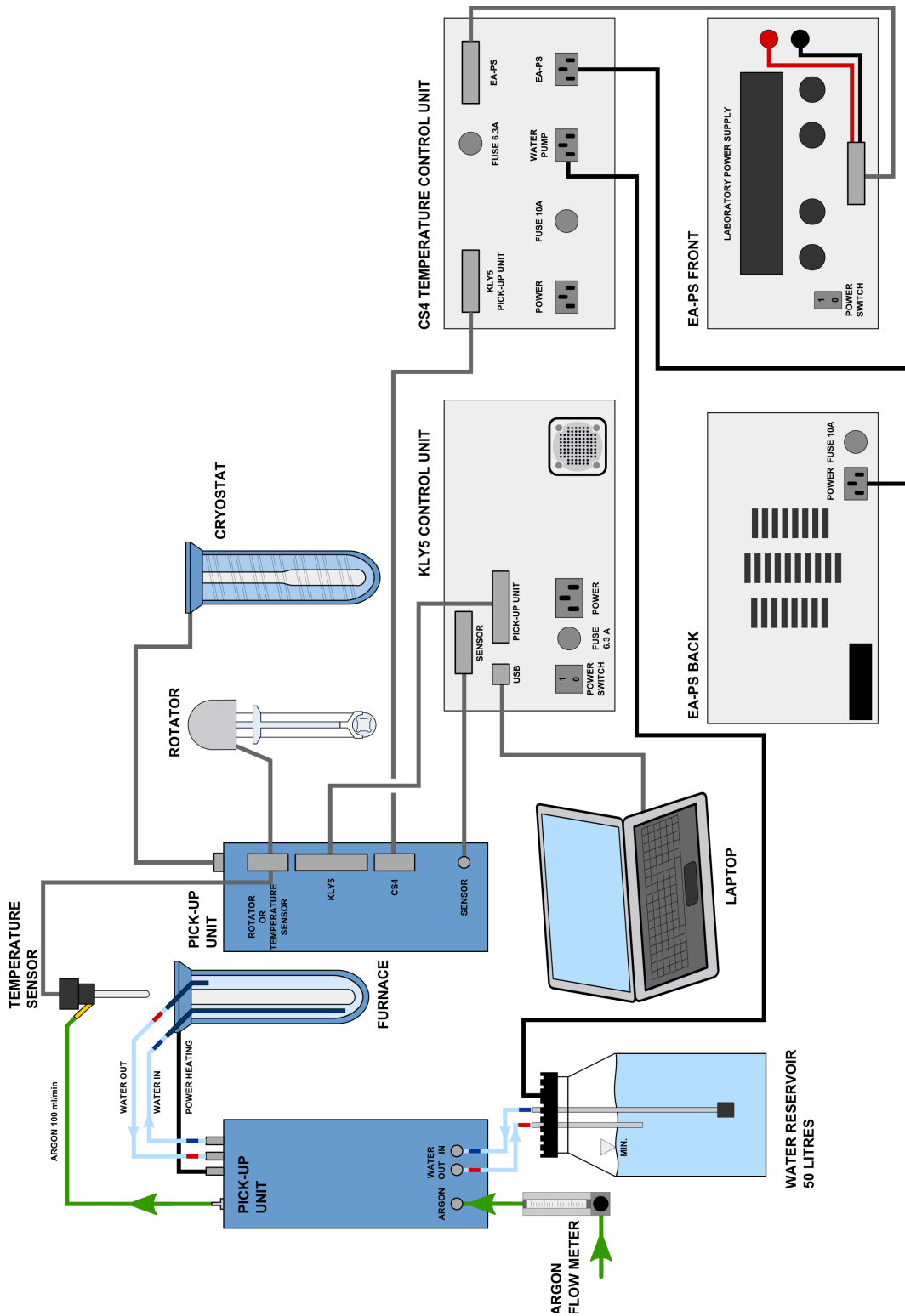


**Figure 1:** Recommended layout of KLY5/CS4 apparatuses parts

### 3.2 Interconnection of Units

Fig.2 shows the Interconnection Scheme. If you are installing only Kappabridge do not consider CS4, laboratory power supply EA-PS and its accessories. **Be sure the instrument is unplugged from mains while connecting the cables. Do not manipulate with any connector while the instrument is ON.** Fix the connectors by screws, plug the mains socket and switch the Kappabridge on.

Check the cables for labels indicating the instrument sub-system to connect to (some cables may have same connectors on both sides, but different internal connections). Hoses of the cooling liquid are labeled with color marks at their end, as well as the connecting points on the barrel and pickup unit. Please check the correct hose connection, in some cases wrong connection can lead to the damage of the instrument.



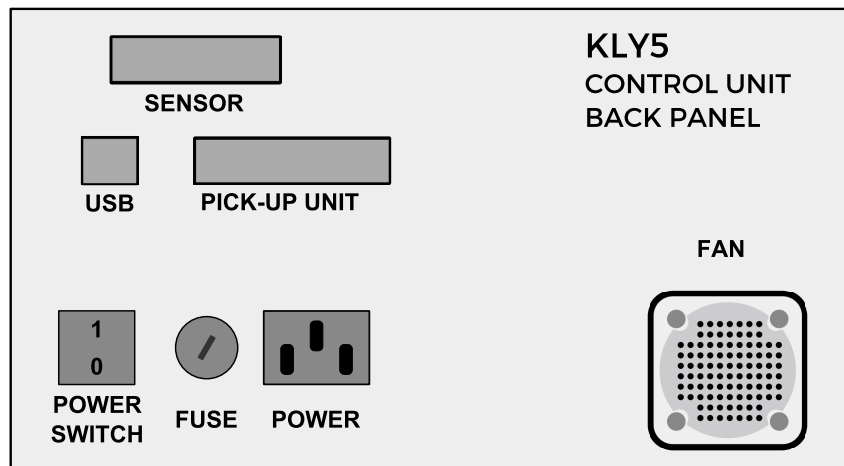
**Figure 2:** Interconnection Scheme of KLY5-A / CS4 / CSL system

### 3.3 Main Switch and Main Fuse

Main switch and main fuse of the KLY5 Kappabridge are located on the back panel of the Control Unit. See Fig.3 for reference. After correct interconnection Kappabridge can be turned ON or OFF by POWER SWITCH.

If needed main fuse can be easily replaced. Use flat head screwdriver to unlock the socket, then pull out the socket. After replacing of the fuse push in the socket and lock it with screwdriver. Rating of the fuse is as follows: T6.3A/250V. T is for time-lag (slow) type fuse, 6.3A is maximal current and 250V is maximal voltage.

- ✘ **Mains cord must be disconnected!** Power switch must be turned off and mains cord must be disconnected from Control Unit during fuse exchange.



**Figure 3:** Back panel of KLY5 Control Unit

### 3.4 Testing the Magnetic Environment

- See section 3.1 before running test. If you do not use notebook or computer with LCD display (we recommend it), take attention to your PC monitor. The monitor distance from pick-up coils and its azimuth position can have sometimes great influence. Be sure there are no other instruments in the vicinity of pick-up coils.
- Switch on the KLY5 and run program **SAFYR7**.
- Open routine `Execute\Sigma Test`. Shortcut [Shift+Del]. Sigma Test window will pop-up. Consult **SAFYR7** manual for more details.

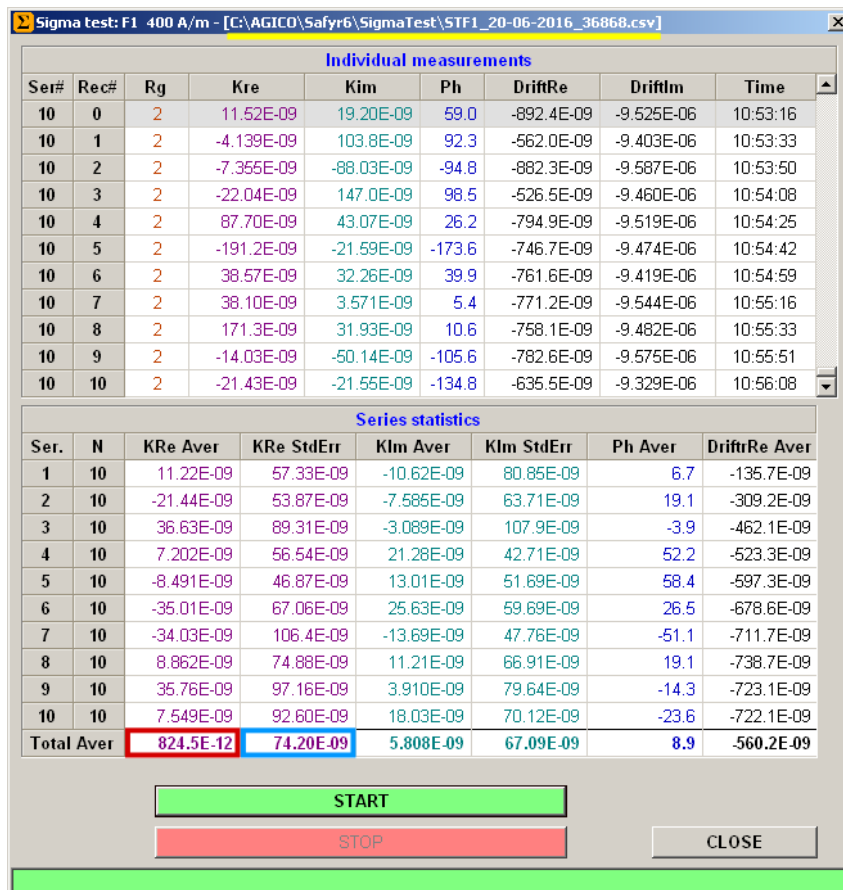


Figure 4: Sigma Test window with results

- Hit **START**
- Sigma test routine will begin after 10 min. of thermal stabilization. This routine consists of 10 sets of 10 measurements of empty coil. From the results

of such measurements average value (which must be close to 0 SI) and standard deviation are calculated.

Up/Down mechanism and rotator are disabled during this routine. Magnetic field is set to 400 A/m.

- Results of Sigma Test are shown on Fig.4. **KRe Aver** represents the mean value of susceptibility calculated from the sets of measurements. Total average of in-phase (real) susceptibility value is marked by the red rectangle - value is close to the zero. **KRe StdErr** represents Standard deviation of in-phase susceptibility estimated from entire routine and it is marked by the blue rectangle. To consider Sigma Test as successful value must be lower than  $20 \times 10^{-9}$  SI.
- Results of Sigma Test are automatically saved to the \*.csv datafile. Path of this file is C:\AGICO\SAFYR7\SigmaTest. Name of the file is derived from actual date and time. Actual path and name of datafile is shown in the header of Sigma Test window (marked by the yellow line in Fig.4).




## 4 Measurements

### 4.1 Operation basics

#### 4.1.1 Switching ON and OFF the instrument

Kappabridge has only one switch which is located on the backside of the Electronic Unit. After switching **ON** the Kappabridge both lights on the Pick-up and Electronic Units must be green. If you notice other combination of the colors, check chapter 5.1.1 for troubleshooting. When Kappabridge is ON run the SAFYR7 software and choose measuring mode in the `Settings|Instrument Configuration` (shortcut [F12]) window (eg. bulk susceptibility, AMS with rotator etc.). Then press **ACTIVATE** button to initialize instrument. Activation window will pop-up and steps of the activation routine are shown.


 It is highly recommended to wait ten minutes after activation routine to establish temperature balance of the instrument (especially measuring coils). It significantly reduces thermal drift during measurement and increases sensitivity of the Kappabridge.

When switching **OFF** the instrument close the software first and then switch off the main switch on the backside of the Electronic Unit.

#### 4.1.2 Measurements with manual holders

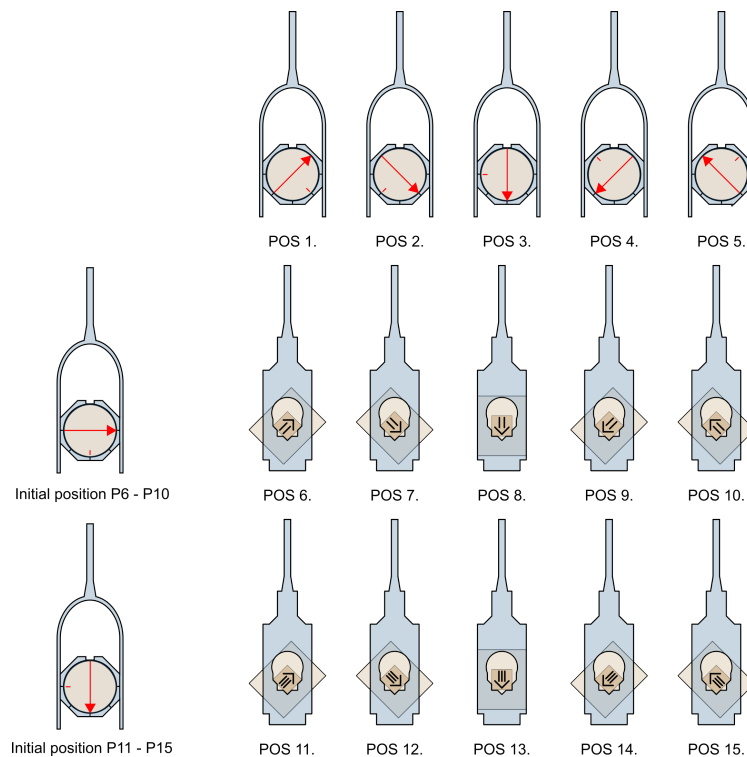
##### Manual measurements

Manual measurements are only possibility for the KLY5-B due to the absence of the Up/Down manipulator. It is also recommended to perform manual measurements when only bulk susceptibility is measured with the KLY5-A. In this case it is necessary to Disable Up/Down manipulator in the `Execute|Auxiliary Commands` window.

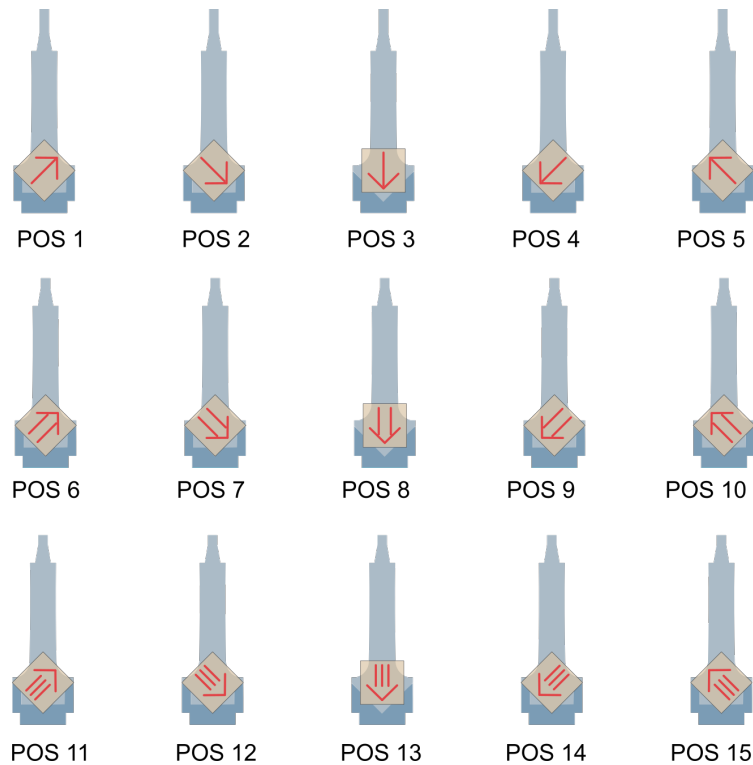
 Plastic cylinder (can be found in the accessories box) must be installed inside the measuring coil to ensure position of the sample in the center of the coil.

Measurement routine is as follows:

- Fill the information about the specimen in the appropriate window in the SAFYR7 software.
- Press **START** button to execute the measuring routine. Empty coil (as the background measurement) will be measured for about four seconds. Do not disturb the instrument during the measurement.
- Wait until first beep and then insert the holder with specimen into the measuring coil. Specimen must be inserted within 3.5second after the beep.
- Wait for second beep and then pull out the specimen from the coil. Specimen must be pulled out within 3.5second after the beep.
- Another empty coil measurement is performed for about four seconds.
- Resulting value of the susceptibility will be shown and saved to the datafile.
- Measure another specimen (bulk susceptibility measurement) or measure next position in the 15-direction measuring design (manual measurement of the AMS, see. Figs.5,6).




**Figure 5:** 15-direction AMS measuring design for cylindrical samples



**Figure 6:** 15-direction AMS measuring design for cubic samples

### Measurements with Up/Down Manipulator

KLY5-A is equipped with Up/Down manipulator which is necessary condition for the measurements with rotators and also brings enhanced comfort of measurements of the field variation of the bulk susceptibility. It can be used for single bulk susceptibility measurements as well.

-  Make sure that the plastic cylinder is NOT inside the coil when Up/Down manipulator is used.

Measurement routine is as follows:


- Make sure that the plastic cylinder is NOT inside the measuring coil.
- Install the adapter for the manual holders into the plastic arm of the Up/Down manipulator.
- Install manual holder into the adapter. Be sure that the holder is all the way down in the adapter.
- Fill the information about the specimen in the appropriate window in the SAFYR7 software.

- Press **START** button to begin measuring routine. Empty coil (as the background measurement) will be measured for about four seconds.
- Up/Down manipulator moves the specimen into the coil, susceptibility is measured, specimen is pulled out of the coil and another empty coil measurement is performed for about four seconds.
- Resulting value of the susceptibility will be shown and saved to the datafile.
- Measure another specimen (bulk susceptibility measurement) or measure next position in the 15-direction measuring design (manual measurement of the AMS).

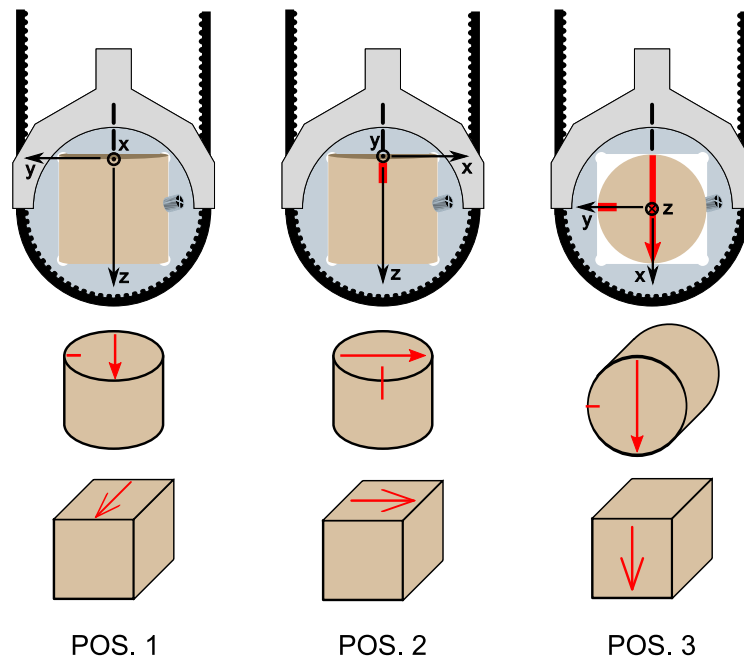
### 4.1.3 Measurements with rotators

Classical rotator was developed for rapid and precise measurement of the anisotropy of magnetic susceptibility of rock samples (cylindrical or cubic shape). 3D Rotator is updated version which brings less manual handling, shortens the measuring time and allows automatic measurement of the field variation of the AMS

#### Measurements with Classical Rotator

-  Make sure that the Kappabridge is switched **OFF**, connect the rotator to the appropriate connector and mount it properly into the plastic arm.

Switch **ON** the Kappabridge, run the SAFYR software, push **ACTIVATE** button, choose AMS measuring mode and continue with the activation. Software detects the type of connected rotator automatically. Run `Execute|Calibration` and `Execute|Holder Correction` using rotator. Measurement of the AMS consists of three measurements of the differential susceptibility in three planes (Position 1 – y,z plane; Position 2 – x,z plane; Position 3 – x,y plane) and additional measurement of the Bulk susceptibility in the x-axis of the specimen coordinate system. Specimen must be inserted into the shell of the rotator in the particular position according to the Fig. 7. Additional bulk susceptibility measurement must be performed with the specimen mounted in the position 3.

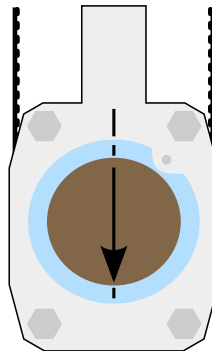


**Figure 7:** Inserting positions for Classical Rotator

### Measurements with 3D Rotator

- ⚠ Make sure that the Kappabridge is switched **OFF**, connect the rotator to the appropriate connector and mount it properly into the plastic arm.

Switch **ON** the Kappabridge, run the SAFYR software, push **ACTIVATE** button, choose AMS measuring mode and continue with the activation. Software detects the type of connected rotator automatically. Run `Execute|Calibration` and `Execute|Holder Correction` using 3D rotator. Routines are similar to the using Classical Rotator major difference is in the inserting position of the specimen which is as shown on the Fig. 8.



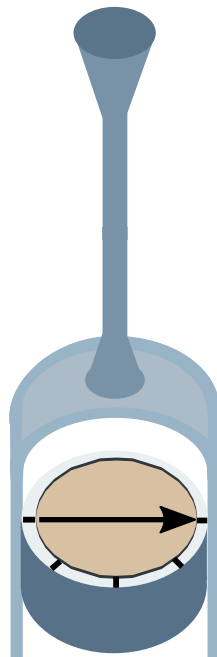
**Figure 8:** Inserting position for 3D Rotator

## 4.2 Calibration

Calibration of the Kappabridge should be performed regularly (once per month at least) to achieve best possible results. Values of the calibration constants within required range are good indicator of the proper function of the Kappabridge. Three different calibration routines are used - bulk calibration with manual holder, bulk and anisotropy calibration with classical rotator, and bulk and anisotropy calibration with 3D rotator.

### 4.2.1 Calibration with manual holder

Only the Gain of the instrument is calibrated when manual holders are used. After click on the `Execute|Calibration` in the Main menu Calibration window appears. Routine itself consists of one measurement of the bulk susceptibility of the calibration standard. Make sure that the calibration standard is inserted as shown on the Fig.9, check the calibration standard values and press **START** button to run calibration routine. After the measurement the software will calculate correct Gain value. Successful calibration is indicated in the Calibration window. New calibration values are saved after pushing of the **SAVE** button.



**Figure 9:** Inserting position calibration with manual holders

 Previous holder correction values are zeroed after calibration.

### 4.2.2 Calibration with rotators

Calibration with the rotator is more complex routine which measures three values - gain for bulk measurements (GainB), gain for anisotropy measurements (GainA) and Delta value which defines the coordinate system during the rotation of the specimen inside the measuring coil. For this reason two measurements are utilized - bulk susceptibility measurement and differential susceptibility measurement. After click on the `Execute|Calibration` in the Main menu (shortcut [F3]) Calibration window appears. Make sure that the calibration standard is inserted properly with respect to the type of the rotator, check the calibration standard values and press **START** button to run calibration routine. After the measurement the software will calculate correct GainB, GainA and Delta value. Successful calibration is indicated in the Calibration window. New calibration values are saved after pushing of the **SAVE** button.

- For calibration with the **classical rotator** insert the calibration standard in the position 1 as shown on Fig. 7.
- For calibration with the **3D rotator** insert the calibration standard as shown on Fig. 8.



Previous holder correction values are zeroed after calibration.

## 4.3 Holder Correction

Holder Correction routine measures empty holder and resulting value is used for the further subtraction of the susceptibility of the holder from the measurement of the specimen.

### 4.3.1 Holder Correction of the manual holders

After calibration with manual perform the Holder Correction. Click on the `Execute|Holder Correction` in the Main menu (shortcut [F4]) and Holder Correction window appears. Routine consists of three measurements of the bulk susceptibility of the empty manual holder. Average value and standard error is calculated from these measurements. Typical value of the susceptibility of the clean empty manual holder is from  $-10 \times 10^{-6}$  to  $0 \times 10^{-6}$  SI units. Standard error should be lower than  $100 \times 10^{-9}$  SI. Successful Holder Correction is indicated in the status bar and Holder Correction values can be saved by pressing the **SAVE** button in the Holder Correction window.

### 4.3.2 Holder Correction of the rotators

After calibration with rotators perform the Holder Correction. After click on the `Execute|Holder Correction` in the Main menu (shortcut [F4]) Holder Correction window appears. Routine consists of three measurements of the bulk susceptibility and and three measurements of the anisotropy of the empty rotator. Average values and standard errors are calculated from these measurements. Typical value of the susceptibility of the clean empty rotator is from  $-5 \times 10^{-6}$  to  $+5 \times 10^{-6}$  SI units. Standard error should be lower then  $100 \times 10^{-9}$  SI. Sin and cos components as well as their errors should be lower then  $100 \times 10^{-9}$  SI units. Successful Holder Correction is indicated in the status bar and Holder Correction values can be saved by pressing the **SAVE** button in the Holder Correction window.













## 5 Troubleshooting and Maintenance

### 5.1 Troubleshooting

KLY5 contains plenty of hardware control circuits and software diagnostic tests to prevent any serious damage to the device. Some potential errors and their solution are noted below. Please keep in mind, that best way to solve problems with AGICO devices, is to contact manufacturer via. email address [agico@agico.cz](mailto:agico@agico.cz). Lifetime email support is free of cost, so do not hesitate to contact us with any questions.

#### 5.1.1 Hardware Error Indications

Actual state of the Kappabridge is indicated by two LED lights located on the front panels of Pick-Up and Control units. Table 1 describes meaning of light colors combinations.

Pick-Up Unit	Control Unit	Meaning and Solution
		Kappabridge is ready to use.
		Pick-Up Unit is not connected, or some voltages inside Pick-Up Unit are not present. Check if sensor cable is properly connected to the electronic unit. Check software error messages (Table 2). If it does not help, contact AGICO for assistance.
		Some voltages inside Control Unit are not present. Check software error messages (Table 2). Contact AGICO for assistance.
		Some of the errors indicated by the software occurred. Check software error messages (Table 2). Other reason can be lack of some voltages inside Control Unit. Contact AGICO for assistance.
		Check if KLY5 is switched ON. Check if mains plug is correctly connected. Check the main fuse. See section 3.3

**Table 1:** LED indicators on front panels of Pick-Up Unit and Control Unit

### 5.1.2 Software Error Messages

Software error messages inform about actual problems of the Kappabridge. Table 2 concludes recommended troubleshooting steps after some error occurs. These error messages are shown in the bottom status bar of **SAFYR7** software.

Error	Solution
Slow rotation	Insufficient speed of rotation of the rotator. Check if the rotator is properly connected. Clean the rotator parts according to the sections 5.2.2 or 5.2.3.
Missing 1x or Missing 64x	Pulses from the rotator optocouplers are not present. Check if the rotator is properly connected. Clean the rotator optocouplers and rotator screen according to the sections 5.2.2 or 5.2.3.
Belt error	White mark on the belt is not recognized or it is not in the proper position. Check the color of the white mark on the belt and clean the rotator optocouplers. Make sure that all the marks on the rotator are properly aligned.
No 3-D Rotator	3D Rotator is not connected.
Rotator Error	Unspecified error of rotator. Clean and adjust rotator according to the sections 5.2.2 or 5.2.3
Position Error	Up/Down mechanism did not reach desired position, or it takes too long to reach the position. Clean the Up/Down mechanism according to the section 5.2.4.
No Connection	Check USB connection between KLY5 Control unit and PC. Check, if the correct driver for KLY5 is installed. Try to unplug and re-plug USB cable.
Zeroing Err. Re or Im	Check magnetic environment in the vicinity of the pick-up unit according to the section 3.4
Overflow Zero	Usually indicates huge thermal drift of the measuring coils. Check section 3.1.
Generator Error	Check the LED behaviour according to section 5.1.1
MFK Fatal Error	Check the LED behaviour according to section 5.1.1
Overflow Empty Coil	Indicates huge magnetic disturbances in the vicinity of the Pick-Up unit. Check section 3.1.


**Table 2:** List of errors shown by software **SAFYR7**

## 5.2 Maintenance

### 5.2.1 Cleaning the Holders and Rotator

It is recommended to clean the specimen holders regularly, especially if you continue with measurement of relatively weak specimens after measuring strong ones. For the cleaning use pure water with a small amount of detergent and soft brush. **Do not use alcohol for cleaning** (it may cause damage due to heat of vaporization).

### 5.2.2 Cleaning the Classic Rotator and Belt

 The **cleanliness** of the rotator and its **correct setting** are the basic conditions for the successful anisotropy measurements of the weak samples.

Small grains of the measured rocks may remain on the shell of the rotator and inside the groove of the white plastic bearing in which the shell is turning causing the scratches, increased friction and measurement disturbance. Clean the rotator if:

- the values of holder corrections are too high
- it makes a suspicious noise during the spinning
- "belt strain value" (see bellow) is higher than 1500.

#### Rotator disassembling for cleaning

- Unscrew three plastic screws on the lid of the rotator, be careful not to lose the screws or plastic washers. See Fig. 10A for reference. Pull the lid gently up to remove it.

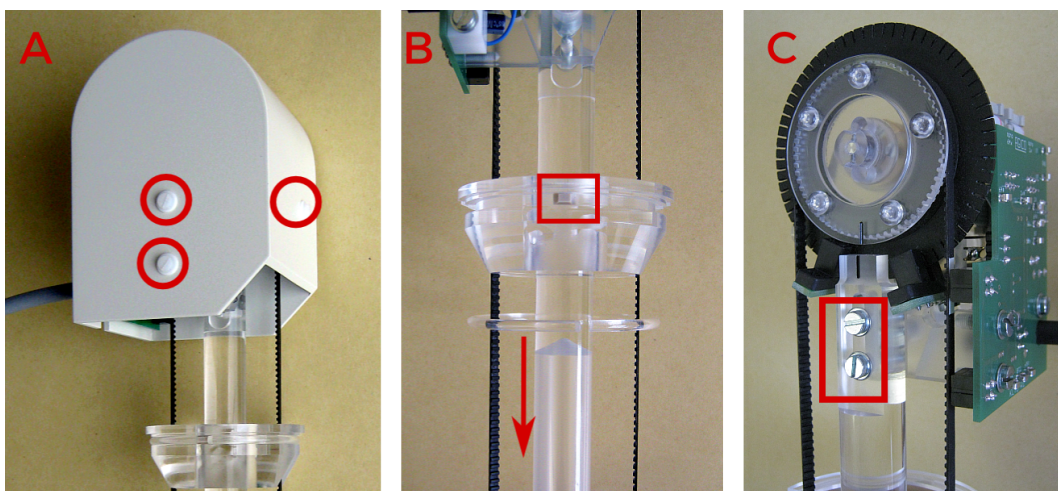
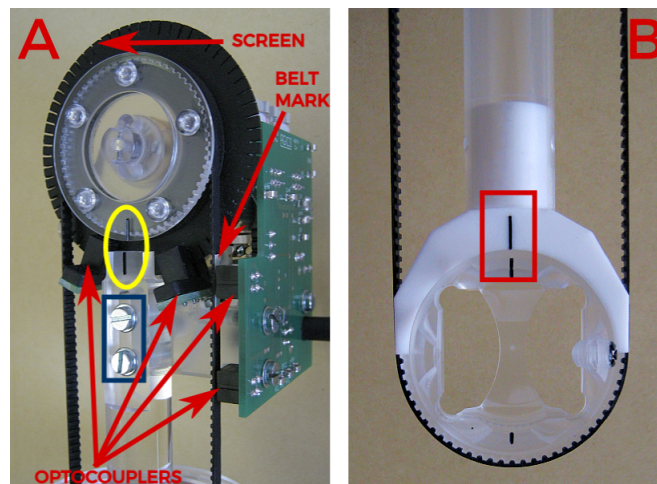


Figure 10: Rotator disassembling

- Check the belt strain to set it later in the similar level and remember the belt mark position.
- Release gently the ring, pay attention to the position and trapezoid shape of rubber washer, be careful not to lose it (see Fig. 10B). Remove the perspex ring.
- Loose a little bit (do not remove them) the two screws, marked in the Fig. 10C.
- The tooth belt eases and the specimen shell can be removed from its bearing.
- Remove the belt from the black wheel.
- Check, if all 64 notches on screen are free. Clean the black wheel, optocouplers and photosensor from dust using soft dry brush.
- Clean the shell, the belt and the bearing, use pure water with a small amount of liquid detergent and soft brush. Check if the belt mark is clear white. **Do not use any kind of alcohol for cleaning.** Dry all the parts after the cleaning.


### Rotator assembling after cleaning

- See Fig. 11 for reference.




**Figure 11:** Rotator assembling

- Turn the wheel with the screen so that two black marks (marked by the yellow ellipse in Fig. 11A) are aligned.
- Position the belt on the wheel so that the white belt mark is approximately in the center of the upper photosensor on the electronic board.
- Insert the shell into the white Teflon bearing so that two black marks (marked by the red rectangle in Fig. 11B) are aligned.

- Check once more the position of the black mark on the wheel and mount the belt on the shell.
  - Adjust the proper belt strain by picking-up slightly the part with motor and fixing the two screws (marked by the blue rectangle in Fig. 11A).
  - Connect the rotator to the KLY5 Pick-Up unit, switch the KLY5 ON, run the **SAFYR7** software and activate the device.
  - Check proper initialization of the rotator by using the **INITIAL POSITION** button in `Execute|Auxiliary commands`. After initialization, all marks mentioned before must be properly aligned.
  - Check the values of the **Rotator supply** by using the **SET SUPPLY** button in the `Execute|Auxiliary commands` menu. This value should be lower than 1400, optimal value is around 1300.
  - If the value is not between 1200 and 1400, then adjust the strain on the belt.
  - You can increase value by increasing strain on the belt or decrease by decreasing the strain on belt.
  - If the **Rotator supply** value is in the desired range, then mount the cover of the rotator with three plastic screws and use rotator as usually.
-  It is necessary to perform calibration and holder correction routine after rotator adjustment.

### 5.2.3 Cleaning of 3D Rotator

-  The **cleanliness** of the rotator and its **correct setting** are the basic conditions for the successful anisotropy measurements of the weak samples.

Please keep your specimens as clean as possible. Any dust particles that fall from your specimens can increase the friction in between 3D-Rotator parts, so the voltage for correct speed of rotator will increase. Higher voltage shortens the lifetime of rotator motor. If the contamination of the rotator is too high, then the rotation may not be so smooth or it can stop to rotate at all.

If the motor driving voltage exceeds 1500 units, then it is necessary to clean your 3D-Rotator or decrease tension on the driving belt.

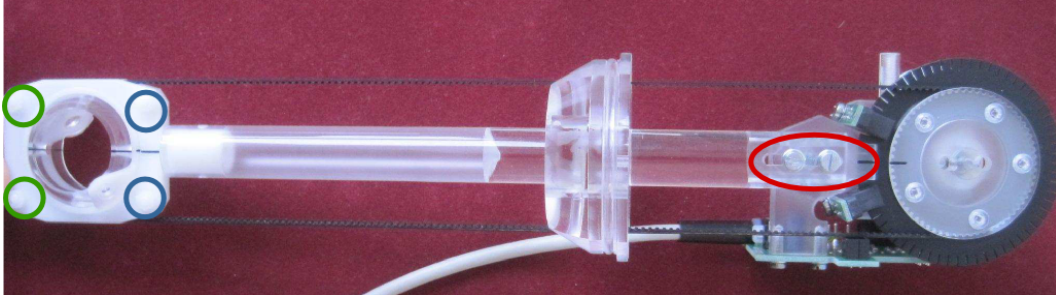


**Figure 12:** Removing of the top cover of the rotator

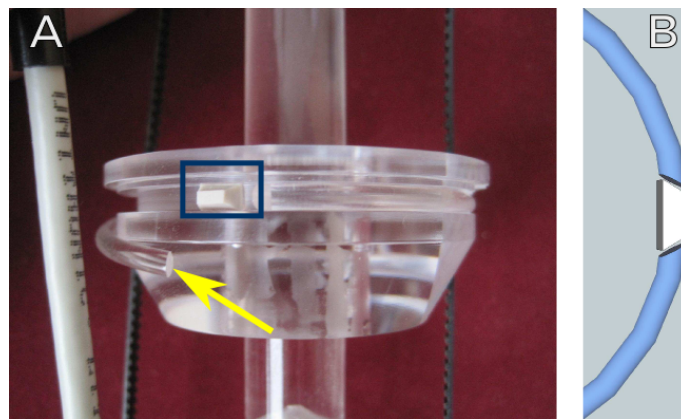
#### 3D Rotator disassembling for cleaning

- Make sure that your Kappabridge is switched off, unplug the rotator.
- Unscrew the plastic screws marked by red circles on Fig.12 and remove the top cover of the rotator.
- Loose two metal screws (just a little bit, half-turn is enough) marked by big red circle on Fig.13, but do not unscrew them. Unscrew the two screws marked by the green circles on Fig.13.
- Remove the plastic ring as shown on Fig.14A. Do not loose the small rubber piece which works as a spacer. It is marked by blue rectangle on Fig.14A. Its correct position with respect to the plastic ring is shown on Fig.14B.
- Remove the belt and clean it with toothbrush (or a similar tool) and warm water. Little bit of detergent can be used as well. **Do not use any solvents such as alcohol, toluene and similar chemicals.**

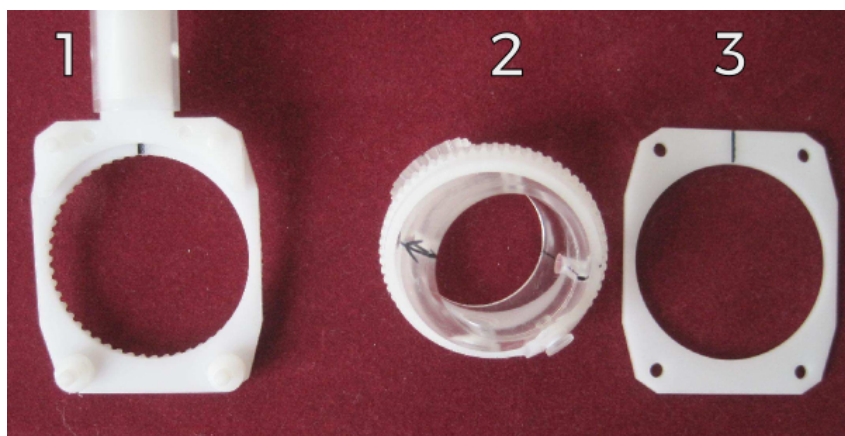
- Unscrew the two plastic screws marked by the blue circles on Fig.13 and dismantle the bottom part of the rotator as seen on Fig.15.



**Figure 13:** Position of the screws on rotator



**Figure 14:** **A** - Plastic ring and white rubber spacer, **B** - correct position of the spacer with respect to the plastic ring

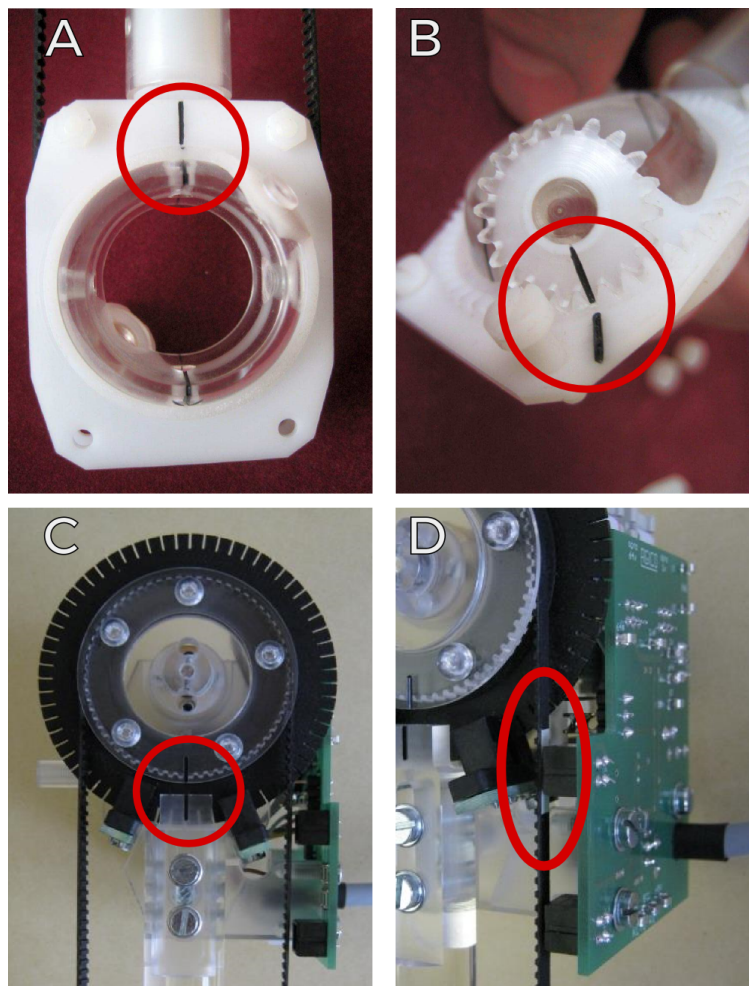


**Figure 15:** Dismantled rotator

- Clean all the parts with a piece of cloth (soft toothbrush) and warm water with little bit of detergent. **Do not use any solvents**, it may cause some serious damage to the 3D-Rotator. Then clean all parts with clear water and dry them as good as possible.

### 3D Rotator assembling after cleaning

- Insert the rotator shell (No.2 on Fig.15) into its holder (No.1 on Fig.15). Make sure that the marks shown on Fig.16 A and B are simultaneously aligned as on the picture. Then cover it with rectangular plate (No.3 on Fig.15) and carefully screw two plastic screws marked on Fig.13 by the blue circles.

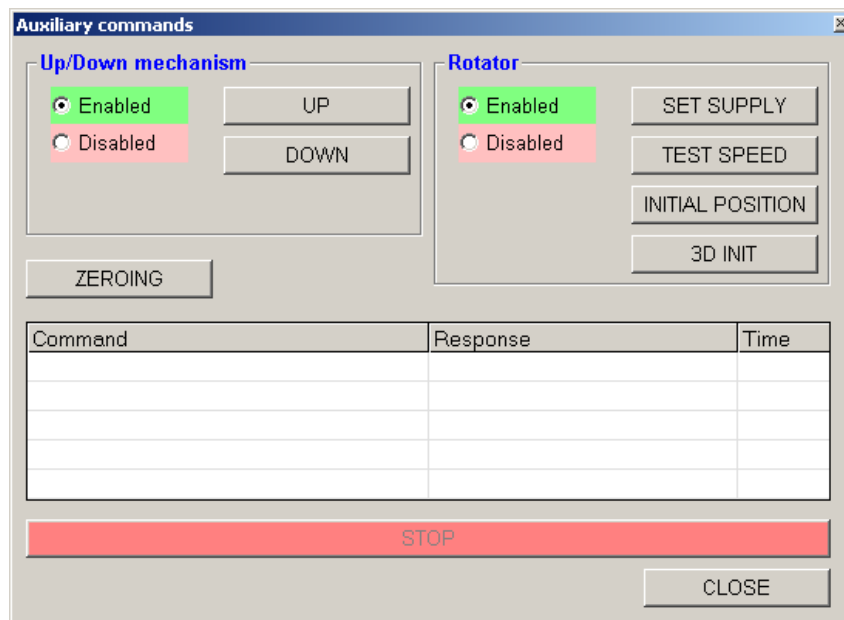


**Figure 16:** Aligning marks on rotator and white mark on belt

- Put on the driving belt and make sure that all the marks shown on Fig.16 A, B, C and D are simultaneously aligned as on the picture.



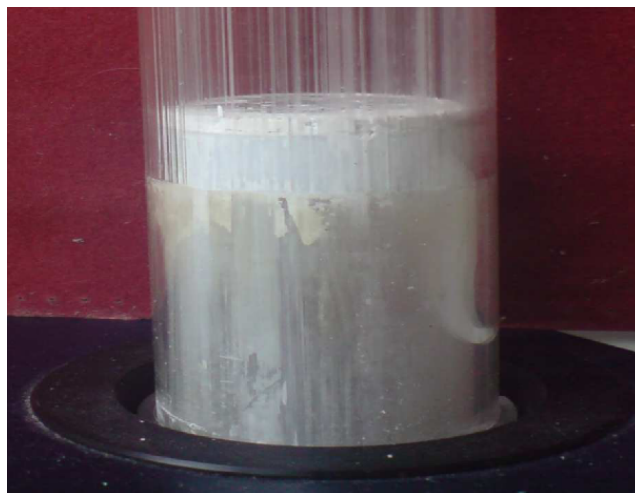
- Gently screw two plastic screws marked on Fig.13 by the green circles. Do not forget to use pads to keep entire system in correct position.
  - Apply some tension on the belt and tighten the metal screws marked on Fig.13 by the red circle. Do not put on the top cover of the rotator, yet.
  - Connect the rotator to the Kappabridge, switch on the KLY5 and run the initialization routine.
  - Open the **Auxiliary commands** window (Execute|Auxiliary commands). Click on the **INITIAL POSITION** button, wait until this procedure is finished and check the position of the marks as shown on Fig.16 A, B, C and D.
  - If the previous step was successful then press the **SET SUPPLY** button and check resulting value of the driving voltage. It is in the instrument units and it should be in the range 1200-1400. If the value is lower then try to increase the tension on the belt a little bit, if it is higher then try to loose the belt somewhat. It is better to reach the lower values in the range from 1200 up to 1300. If the voltage is in the desired range, put on the top cover, use the three plastic screws to fix cover (screw them with care) and your rotator is ready for use.
- ⚠ It is necessary to perform calibration and holder correction routine after the rotator adjustment.



**Figure 17:** Auxiliary commands window

#### 5.2.4 Cleaning of Up/Down Mechanism

The Up/Down mechanism gets dirty after some time of use. Fig.18 shows example of heavy contamination. It is heavily loaded especially during the high / low temperature measurement, when the number of up/down cycles is significantly greater than during the anisotropy measurement and the mass of the load is also higher. The dust and the small flakes of the Teflon spacer accumulate on the inner surface of the plastic tube, which consequently causes creation of the scratches on the inner surface of the tube. Accumulated particles also increase the friction in the system.



**Figure 18:** Example of heavy contaminated Up/Down mechanism

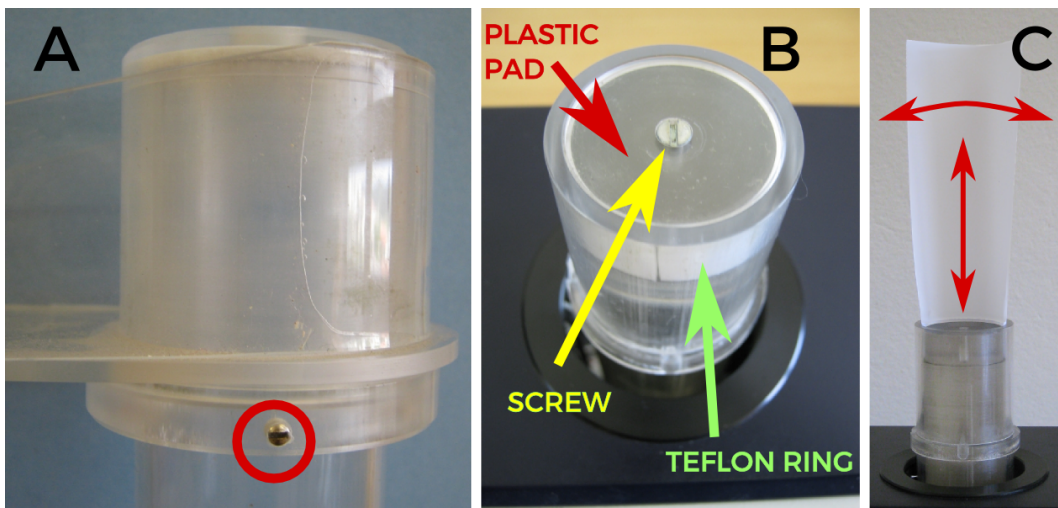
The Up/Down Mechanism should be cleaned in the case that the mechanism makes suspicious noise during the movement and/or if:

- The time of the movement of the holder from lower to upper position is longer than **3.6 s**.
- If the massive linear white contamination traces are present on the inner surface of the cylinder.
- Some "strange" noise is present.

The Up/Down execution time can be checked using  and  buttons in **Auxiliary commands** window (Execute|Auxiliary commands) of **SAFYR7** program.

### Cleaning procedure

- See Fig.19 for reference.
- Open the **Auxiliary commands** window (Execute|Auxiliary commands) and set the Up/Down Mechanism to the down position using **DOWN** button.
- After loosening the small screw (Fig.19A) remove the arm of the holder. Please use the proper size of screwdriver not to damage the screw.
- Check the position of the white Teflon ring (Fig.19B) to reinstall it later into the same position and angular orientation. Then remove the screw and the plastic pad and, at last, the white Teflon ring.



**Figure 19:** Cleaning of the Up/Down mechanism

- Prepare several strips of the paper like this: about 30 cm in length of trapezoid shape, with bases 5 and 2 cm, thickness of about 0.1 mm. Standard office paper for printers is fine.
- Using the paper strips clean the space inside the cylinder. Insert the paper into the gap between the inner cylinder and outer tube and clean the inner cylinder space by moving papers along the inner surface of the cylinder and simultaneously by moving them a little bit up and down (Fig.19C).
- Wash the Teflon ring in the water, dry and reinstall it, checking its proper position and angular orientation inside the cylinder. Insert the washer and tighten it gently by the fixing screw. Mount the arm of the holder and fix it gently again by the screw.

- Check the Up/Down execution time using the  and  buttons in the **Auxiliary commands** window (Execute|Auxiliary commands) of **SA-FYR7** program. Up time with installed rotator or furnace must be lower than **3.6 s**.
- Do not lubricate the inner cylinder by any lubricant. **Do not use alcohol for cleaning** (may cause damage of cylinder due to evaporation heat). In case that the cleaning does not fix the problem, do not try to solve it yourself, contact the manufacturer.

## 6 Appendix

### 6.1 Specimen coordinate system

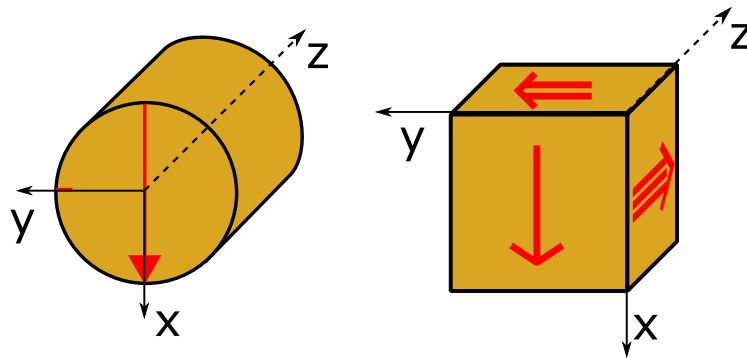


Figure 20: Specimen coordinate system

### 6.2 List of Magnetic Anisotropy Factors

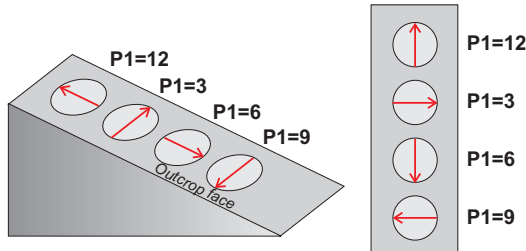
$k_1 > k_2 > k_3$  are principal normed susceptibilities and  $n_1, n_2, n_3$  are their respective natural logarithms. Bold numbers indicate default set of AGICO.

Factor No.	Mathematical expression	Usual Abbreviation
1	$\frac{15}{2} \frac{(k_1 - k)^2 + (k_2 - k)^2 + (k_3 - k)^2}{(3k)^2}$	
<b>2</b>	$\exp \sqrt{2((n_1 - n)^2 + (n_2 - n)^2 + (n_3 - n)^2)}$	P'
3	$\sqrt{2[(n_1 - n)^2 + (n_2 - n)^2 + (n_3 - n)^2]}$	lnP'
<b>4</b>	$\frac{k_1}{k_3}$	P
5	$\ln \frac{k_1}{k_3}$	lnP
6	$100 \frac{k_1 - k_3}{k_1}$	
7	$\frac{k_1 - k_3}{k_2}$	
8	$\frac{k_1 - k_3}{k}$	
<b>9</b>	$\frac{k_1}{k_2}$	L
10	$\ln \frac{k_1}{k_2}$	lnL
11	$\frac{k_1 - k_2}{k}$	
12	$\frac{2k_1}{k_2 + k_3}$	
<b>13</b>	$\frac{k_2}{k_3}$	F

14	$\ln \frac{k_2}{k_3}$	InF
15	$\frac{k_1+k_2}{2k_3}$	
16	$\frac{k_1+k_3}{2k_2}$	
17	$\frac{2k_2}{k_1+k_3}$	
18	$\frac{1-k_3}{k_2}$	
19	$\frac{2k_1-k_2-k_3}{k_1-k_3}$	
20	$\frac{(k_1+k_2)/2-k_3}{k}$	
21	$\frac{k_2-k_3}{k}$	
22	$\frac{k_1}{\sqrt{k_2 k_3}}$	
23	$\frac{k_1 k_3}{k_2^2}$	
<b>24</b>	$\frac{k_1-k_2}{(k_1+k_2)/2-k_3}$	Q
25	$\frac{k_1-k_2}{k_2-k_3}$	
26	$\frac{k_2-k_3}{k_1-k_2}$	
27	$\arcsin \sqrt{\frac{k_2-k_3}{k_1-k_2}}$	
<b>28</b>	$\frac{k_2^2}{k_1 k_3}$	E
29	$k_2 \frac{k_1-k_2}{k_1(k_2-k_3)}$	
30	$\frac{k_2/k_3-1}{k_1/k_2-1}$	
<b>31</b>	$\frac{2n_2-n_1-n_3}{n_1-n_3}$	T
<b>32</b>	$\frac{2k_2-k_1-k_3}{k_1-k_3}$	U
33	$\frac{k_1+k_2-2k_3}{k_1-k_2}$	
34	$\frac{\sqrt{((k_1-k)^2+(k_2-k)^2+(k_3-k)^2)/3}}{k}$	R
35	$(k_1 k_2 k_3)^{\frac{1}{3}}$	
36	$\frac{k_3(k_1-k_2)}{k_1(k_2-k_3)}$	
37	$\frac{k_3(k_1-k_2)}{k_2^2-k_1 k_3}$	
38	$\frac{(k_1-k_2)(2k_1-k_2-k_3)}{(k_2-k_3)(k_1+k_2-2k_3)}$	

### 6.3 Orientation parameters

#### Parameter P1

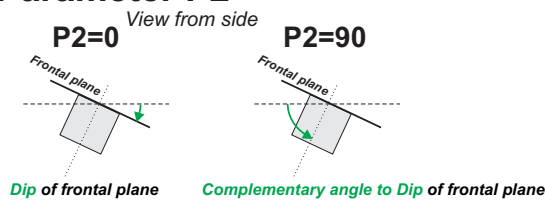


P1 is a clock value orientation of the **Arrow** which represents the x-axis of Specimen coordinate system (right hand rule, see *Legend*). The **Arrow** may be drawn:

- P1=12 Upslope
- P1=3 To the Right
- P1=6 Downslope
- P1=9 To the Left

Note that the **Azimuth** of the **Arrow** may, or may not be measured (see Parameter P3).

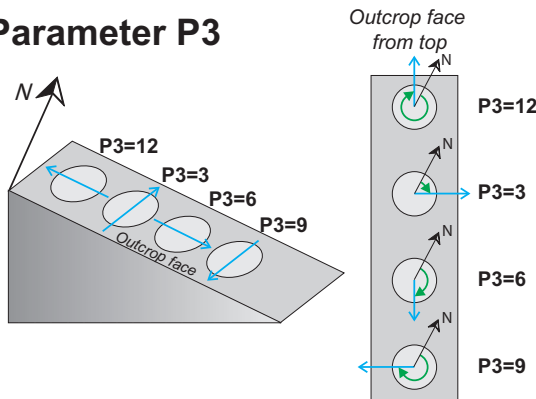
#### Parameter P2



P2 indicates which angle is measured as the specimen inclination.

- P2=0 **Dip** of specimen frontal plane
- P2=90 **Plunge** of specimen z-axis (Complementary angle to Dip of specimen frontal plane)

#### Parameter P3

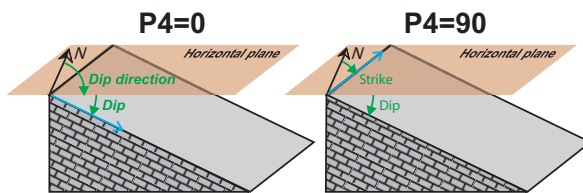


P3 is a clock value that indicates which **Direction** on the specimen frontal plane (x-y plane) is measured using geological compass and expressed as **Azimuth**.

- P3=12 Antipode of Dip direction
- P3=3 Right-handed Strike
- P3=6 Dip direction
- P3=9 Left-handed Strike

Note that the measured **Direction** may, or may not, coincide with **Arrow** (see Parameter P1).

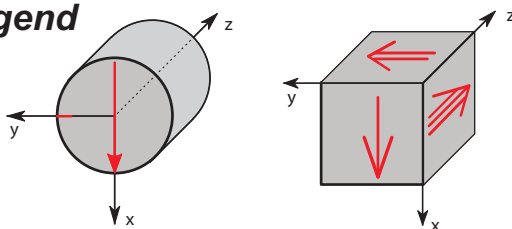
#### Parameter P4



P4 indicates how mesoscopic foliation adjacent to the specimen is measured.

- P4=0 **Dip direction/Dip** notation is used
- P4=90 **Strike/Dip** notation is used (right hand rule)

#### Legend



- Red Markings drawn on specimen
- Blue Measured directions (not drawn)
- Green Orientation angles

**Azimuth** is measured as a clockwise angle from North and it is expressed in degrees <0-360°. Anticlockwise angles are not allowed!

Figure 21: Orientation parameters

## 6.4 EC Declaration of Conformity

We,

AGICO, s.r.o., Ječná 29a, CZ - 621 00 Brno, IČO 607 313 54,

declare that the product:

Name:	Modular system for measuring in-phase and out-of phase magnetic susceptibility, anisotropy of in-phase and out-of phase magnetic susceptibility and temperature variation of in-phase and out-of phase magnetic susceptibility.	
Modulus Type:	KLY5	indicator of in-phase and out-of phase susceptibility and its anisotropy at variable fields,
Modifications:	KLY5-A	indicator of in-phase and out-of phase magnetic susceptibility and its anisotropy with rotating sample,
	KLY5-B	indicator of in-phase and out-of phase magnetic susceptibility and its anisotropy,
Modulus Type:	CS4	indicator of temperature variation of susceptibility from room temperature to 700 °C,
Modulus Type:	CSL	indicator of temperature variation of susceptibility from -192 °C to room temperature,
Manufacturer:	AGICO, s.r.o., Ječná 29a, CZ - 621 00 Brno, IČO 607 313 54	
Place of production:	AGICO, s.r.o., Ječná 29a, CZ - 621 00 Brno, IČO 607 313 54	

fulfills the safety requirements for electrical equipment for measurement, control, and laboratory use:



Safety tests

Certificated by Engineering Test Institute, Brno, Czech Republic.  
Certificate number E-31-01024-16.

Instrument is certificated by using Directive 2014/35/EU. ČSN EN 61010-1 ed.2:2011  
Certification scheme: ČSN EN ISO/IEC 17067:2014, Scheme 1a

Electromagnetic compatibility test

Testing by ITC (Institute for testing and certitacion), Uherske Hradiště, Czech Republic. Test report number: 414103103AE1.  
EN 61326-1:2013  
EN 55022:2010  
EN61000-3-2:2014  
EN61000-3-3:2013  
EN61000-4-2:2009  
EN61000-4-3:2006  
EN61000-4-4:2012  
EN61000-4-5:2006  
EN61000-4-6:2009  
EN61000-4-11:2004

Responsible person: Bc. Petr Pokorný, development engineer

## 6.5 Warranty

AGICO warrants that this product will be free from defects in materials and workmanship for a period of usually 1 (one) year from date of installation. However, if the installation is performed later than 3 (three) months after the date of shipment due to causes on side of Customer, the warranty period begins three months after the date of shipment. If any such product proves defective during this warranty period, AGICO, at its option, either will repair the defective product without charge for parts and labor, or will provide a replacement in exchange for the defective product.

In order to obtain service under this warranty, Customer must notify AGICO of the defect before the expiration of the warranty period and make suitable arrangements for the performance of service. AGICO will decide if the repair is to be performed by AGICO technician or AGICO delegated serviceman in customers laboratory, or product shall be sent for repair to the manufacturer. In latter case, customer shall be responsible for packaging and shipping the defective product to the AGICO service centre. In both cases, all the costs related to a warranty repair shall be at expenses of AGICO.

The warranty becomes invalid if the Customer modifies the instrument or fails to follow the operating instructions, in case of failure caused by improper use or improper or inadequate maintenance and care, or if the Customer attempts to install the instrument without explicit written permission of AGICO company. AGICO shall not be obligated to furnish service under this warranty

- to repair damage resulting from attempts by personnel other than AGICO representatives to install, repair or service the product;
- to repair damage resulting from improper use or connection to incompatible equipment; or
- to service a product that has been modified or integrated with other products when the effect of such modification increases the time or difficulty of servicing the product.

This warranty is given by AGICO with respect to this product in lieu of any other warranties, expressed or implied. AGICO and its vendors disclaim any implied warranties of merchantability or fitness for a particular purpose. AGICO's responsibility to repair or replace defective products is the sole and exclusive remedy provided to the Customer for breach of this warranty. AGICO and its vendors will not be liable for any indirect, special, incidental, or consequential damages irrespective of whether AGICO or vendor has advance notice of the possibility of such damages.