

## Features:

- Frequency Range: 17 – 21 GHz
- P1dB: 35 dBm
- IM3 Level -45dBc @ Po=20dBm/tone
- Gain: 27 dB
- Vdd =6 V
- Ids = 1500 to 2800 mA
- Input and Output Fully Matched to 50 Ω

## Applications:

- Communication systems
- Microwave instrumentations
- Point to Point Radios

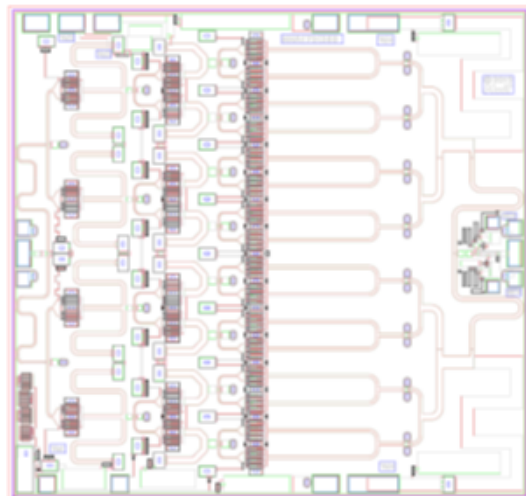

Die size: 2.95mm X 2.80mm X 0.05mm

## Description:

The MMA-172135D is a broadband GaAs MMIC Power amplifier with 3-Watt output power and high gain of 27dB over full 17 to 21GHz frequency range. This amplifier was optimally designed for high linearity applications at 12dB back-off from P-1 condition.

## Absolute Maximum Ratings: (Ta= 25 °C)\*

SYMBOL	PARAMETERS	UNITS	Min.	Max.
Vds	Drain-Source Voltage	V		6.5
Vg	Gate-Source Voltage	V	-2.1	0
Ig	First Gate Current	mA	-17	17
Pd	Power Dissipation	W		16.8
Pin max	RF Input Power	dBm		20
Toper	Operating Temperature	°C		-40 to +85
Tch	Channel Temperature	°C		+150
Tstg	Storage Temperature	°C		-55 to +150
Tmax	Max. Assembly Temp (20 sec max)	°C		+250

\*Operation of this device above any one of these parameters may cause permanent damage.

**Electrical Specifications:** *V<sub>ds</sub>=6V, V<sub>g</sub>=-0.85V, I<sub>ds</sub>=2000mA, T<sub>a</sub>=25 °C Z<sub>0</sub>=50 ohm*

Parameter	Units	Typical Data
<b>Frequency Range</b>	GHz	17 - 21
<b>Gain (Typ / Min)</b>	dB	27 / 26
<b>Gain Flatness (Typ / Max)</b>	+/-dB	1 / 1.5
<b>Input RL(Typ/Max)</b>	dB	12/10
<b>Output RL(Typ/Max)</b>	dB	12/10
<b>Output P1dB(Typ/Min)</b>	dBm	34.5/33.5
<b>IM3 Level @Po=20dBm/tone</b>	dBc	-45
<b>Output Psat(Typ/Min)</b>	dBm	36/35.5
<b>Operating Current at P1dB (Typ/Max)</b>	mA	2000 / 2500
<b>Thermal Resistance</b>	°C /W	3.8

(1) Output IM3 is measured with two tones at output power of 20 dBm/tone separated by 20 MHz.

## Typical RF Performance: $V_{ds}=6V$ , $V_g=-0.85V$ , $I_{ds}=2000mA$ , $Z_0=50\text{ ohm}$ , $T_a=25\text{ }^\circ\text{C}$

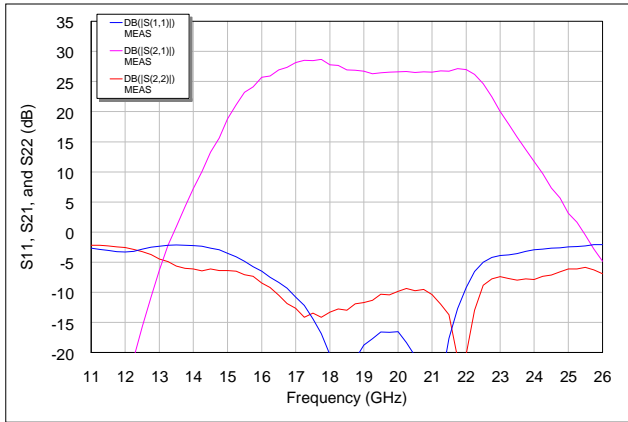

S11[dB], S21[dB], and S22[dB] vs. Frequency

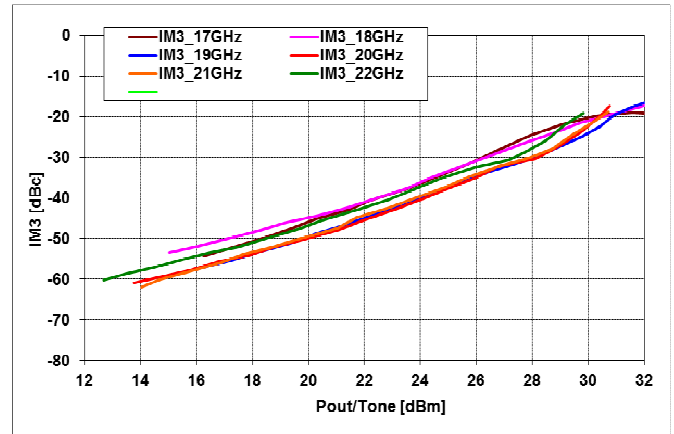

IM3 Level [dBc] vs. output power/ tone [dBm]

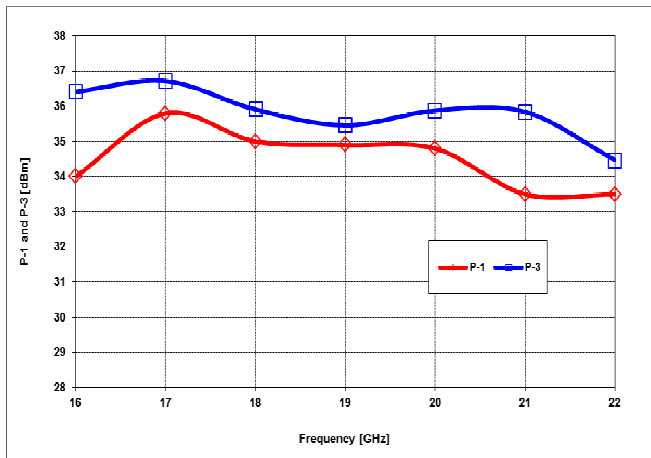

P-1 and Psat vs. Frequency

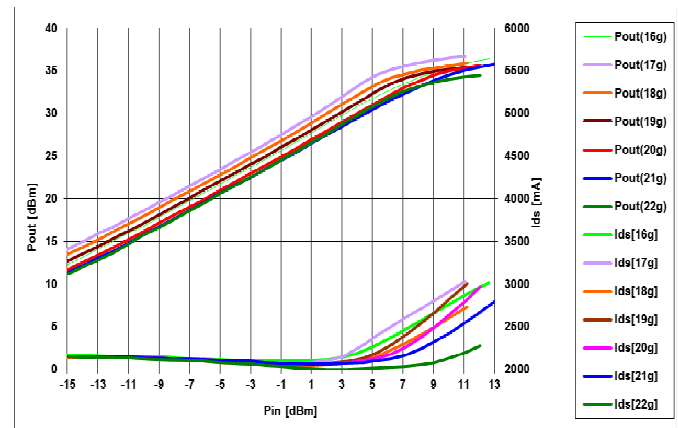

Pout[dBm], and Ids[mA] vs. Input power [dBm]

## Typical Bias dependent RF Performance:

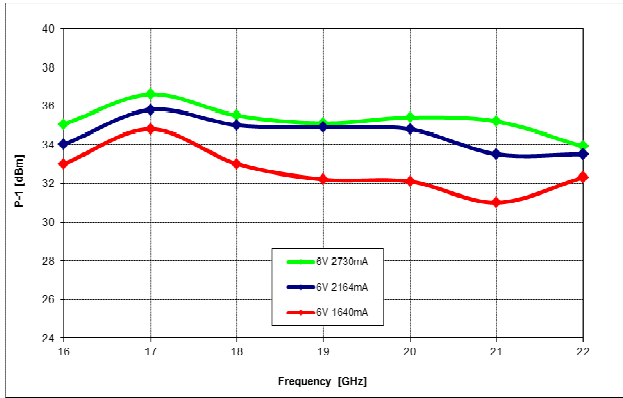

Bias dependent P1 vs. Frequency

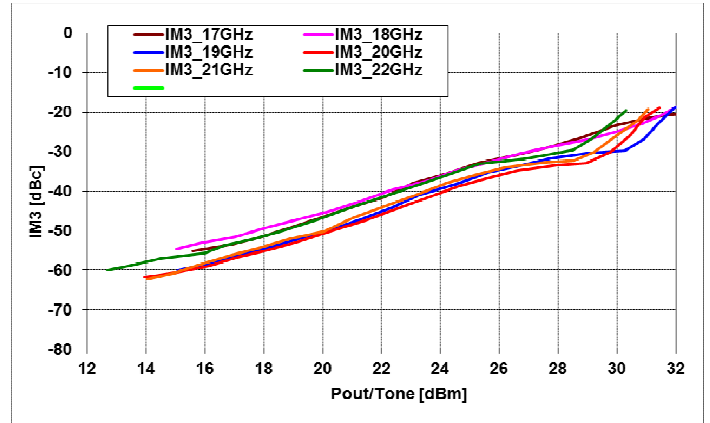

IM3 Level [dBc] vs. output power/tone [dBm]  
@Vds=6V, Idsq=2.5A

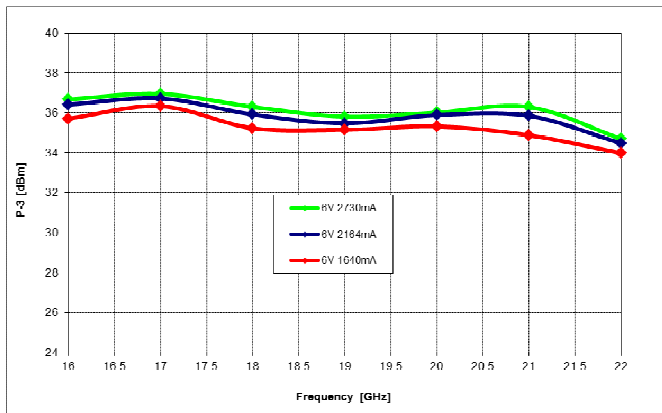

Bias dependent P-3 vs. Frequency

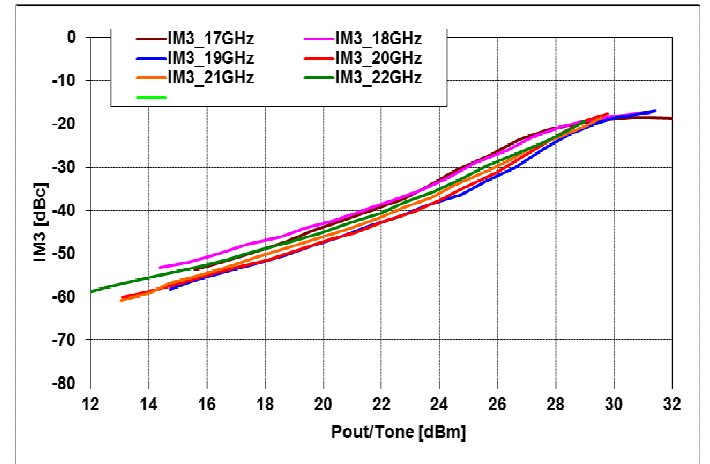

Pout[dBm], and Ids[mA] vs. Input power [dBm]  
@Vds=6V, Idsq=1.5A

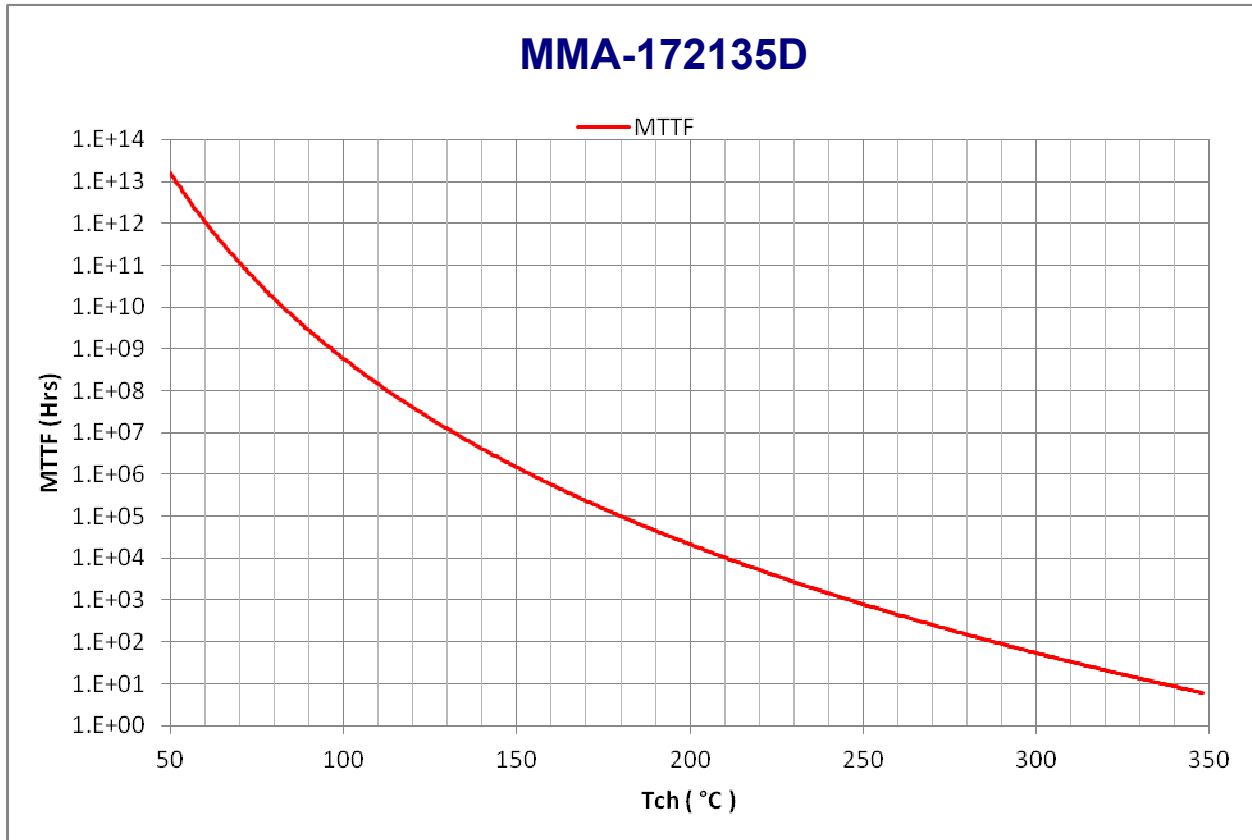

This plot is based on MTTF data provided by wafer foundry and is scaled to the size of this MMIC size.

---

## Applications

The **MMA-172135D** MMIC power amplifier is designed for use as a power stage amplifier in microwave transmitters. It is ideally suited for 17 to 21GHz band point to point radio applications requiring a flat gain response and excellent linearity performance.

## Biasing and Operation

The recommended bias conditions for best performance for the **MMA-172135D** are  $V_{DD} = 6.0V$ ,  $I_{dsq} = 2000mA$ . Performance improvements are possible depending on applications. The drain bias voltage range is 5 to 6V and the quiescent drain current biasing range is 1500mA to 2800mA. A single DC gate supply connected to  $V_g$  will bias all the amplifier stages. Muting can be accomplished by setting  $V_g$  to the pinch-off voltage ( $V_{p}=-2V$ ). The gate voltage ( $V_g$ ) should be applied prior to the drain voltages ( $V_{d1}$ ,  $V_{d2}$ ,  $V_{d3}$ ) during power up and removed after the drain voltages during power down. The RF input and output ports are DC decoupled internally. Typical DC supply connection with bi-passing capacitors for the **MMA-172135D** is shown in following pages.

## Assembly Techniques

GaAs MMICs are ESD sensitive. ESD preventive measures must be employed in all aspects of storage, handling, and assembly. MMIC ESD precautions, handling considerations, die attach and bonding methods are critical factors in successful GaAs MMIC performance and reliability.

## Application Circuit:

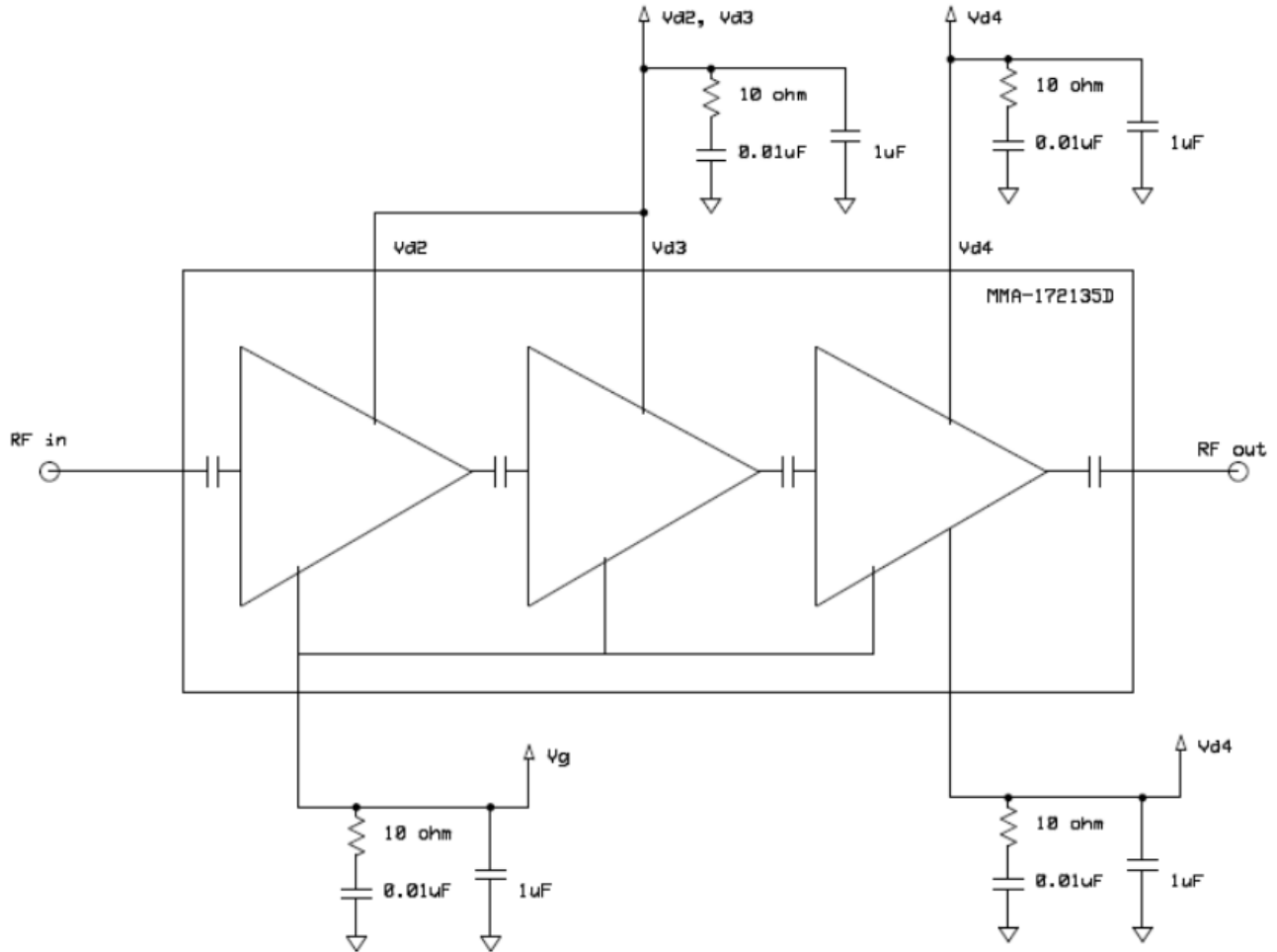

## Pad Sizes:

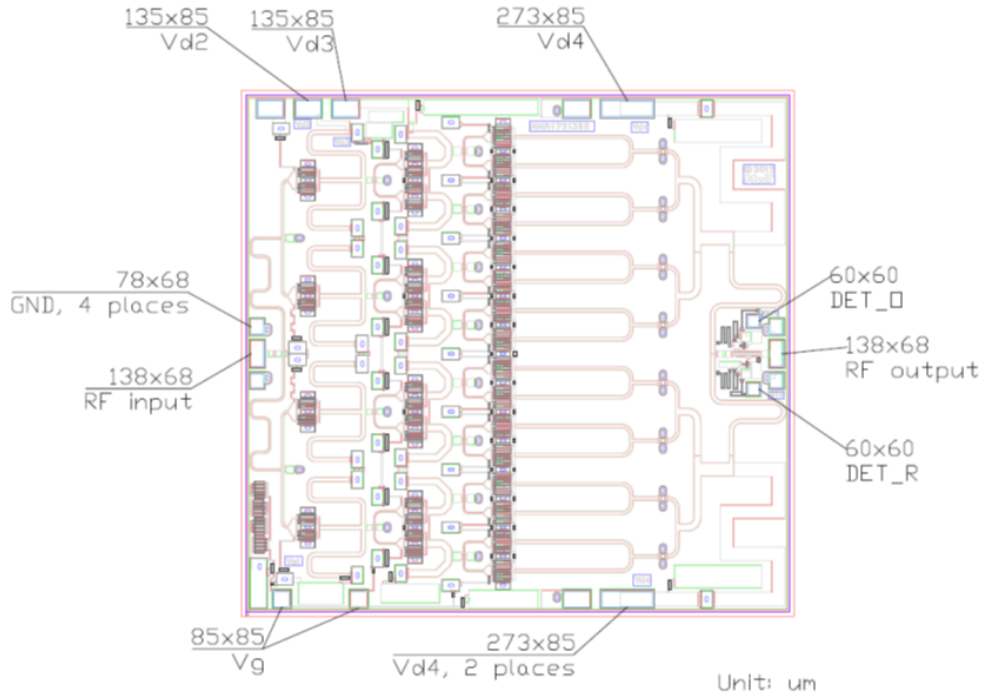

## Pad Locations:

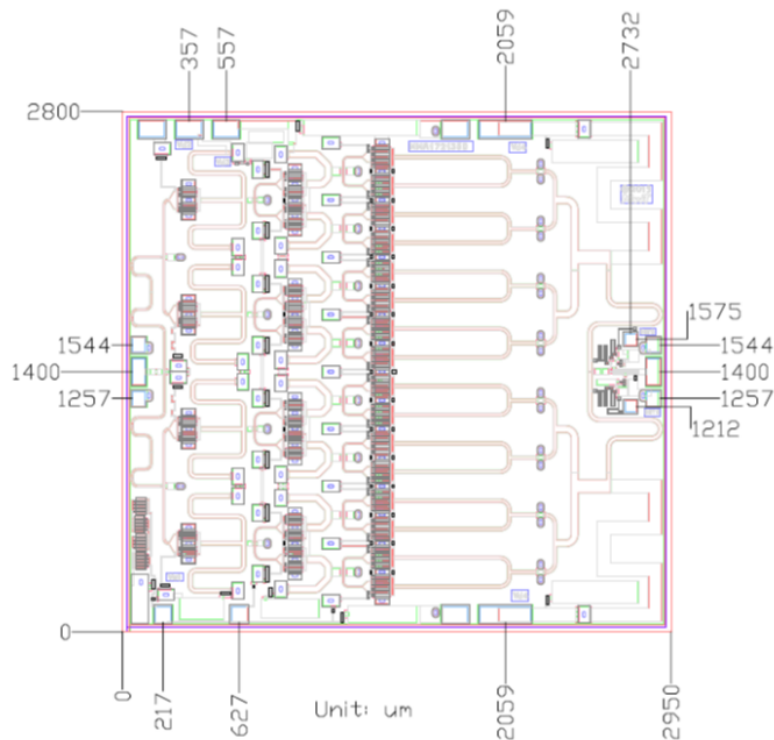



## Recommended Application Board Design:

Board Material is 10mil (Dielectric) thickness Rogers 4350B with 0.5oz copper clads. The board material and mounting pattern, as defined in the data sheet, optimizes RF performance and is strongly recommended. An electronic drawing of the land pattern is available upon request from MwT Sales & Application Engineering.

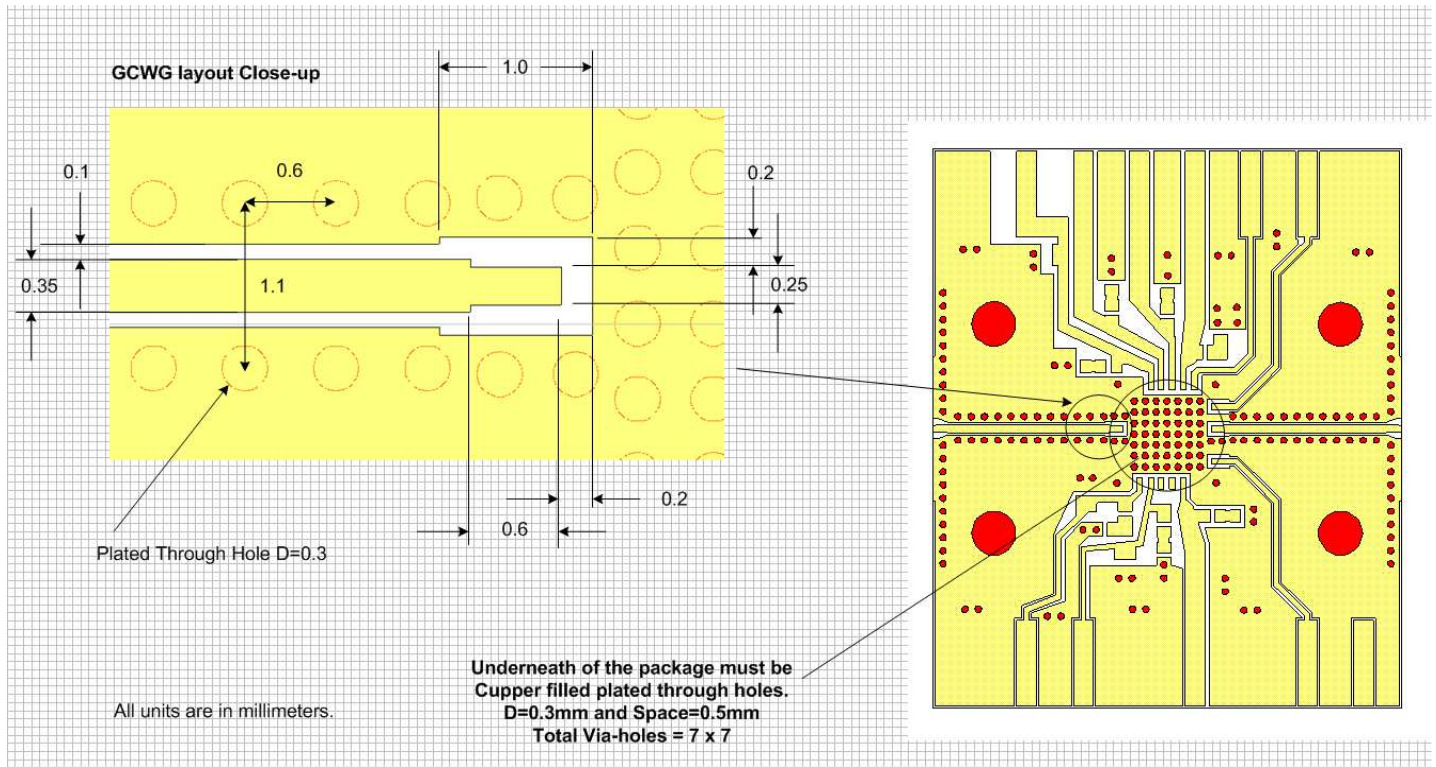

Copper filled thru vias  
D=0.3mm, Space=0.5mm  
7x7

For best thermal  
dissipation, 3mm square  
Copper filled PCB is  
recommended.

