

GROUND FASTENING LAYOUT (SECTION A-A)

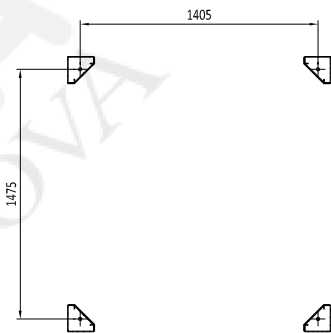

INLET FLANGE DETAIL

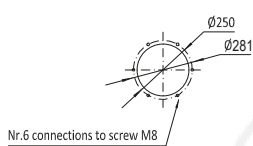

OUTLET FLANGE DETAIL

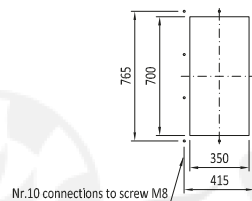

TECHNICAL SPECIFICATIONS

ITEM CODE	OPF-R 2x2	
Weight	kg	1100
Number of filtering elements	nr	4
Filtering surface	m ²	84
Filtering efficiency	99,999% on 0,5 micron dust particles	
Max working negative pressure	Pa	5000
Working Temperature	°C	-10<T<40
Pneumatic feeding (ISO Class 2.4.1 according 8573-1:2010)	Ø	12
Electric feeding	400 V- 50 Hz	
Cartridge cleaning system	pulse-jet	
Number of cleaning valves	nr	4
Type of cleaning valves	Ø1" - 24 VDC	
Compressed air tank working pressure	bar	5,5
PERFORMANCE CHARACTERISTICS		
Nominal air flow	m ³ /h	3300
Nominal static pressure	Pa	3340
Nominal fan power	kW	5,5
Max compressed air consumption	NI/min	360
Average level of sound pressure LpA_1.5m (UNI EN ISO 3746)	dB(A)	<80

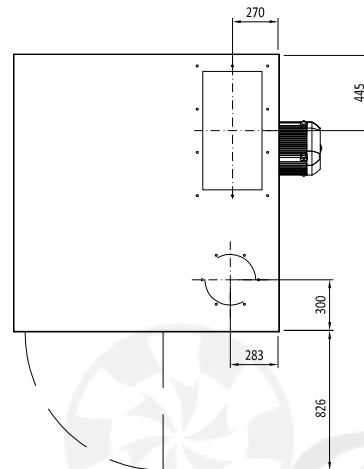
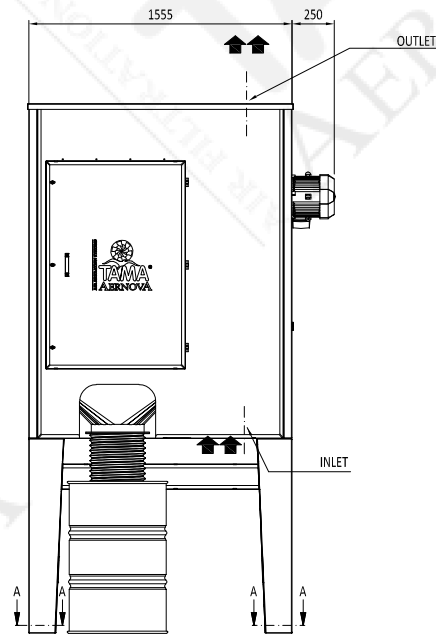
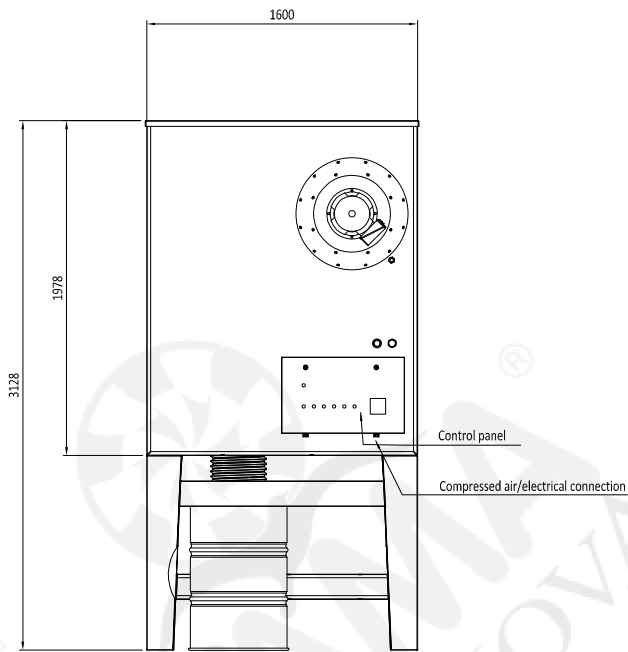

GROUND FASTENING LAYOUT (SECTION A-A)

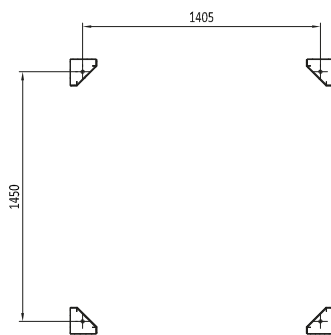

INLET FLANGE DETAIL

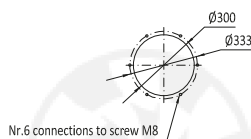

OUTLET FLANGE DETAIL

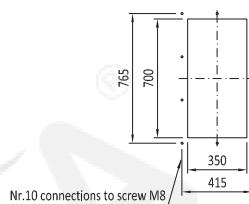

TECHNICAL SPECIFICATIONS

ITEM CODE	OPF-R 2x3	
Weight	kg	1200
Number of filtering elements	nr	6
Filtering surface	m ²	126
Filtering efficiency	99,999% on 0,5micron dust particles	
Max working negative pressure	Pa	5000
Working Temperature	°C	-10<T<40
Pneumatic feeding (ISO Class 2.4.1 according 8573-1:2010)	Ø	12
Electric feeding	400 V - 50 Hz	
Cartridge cleaning system	pulse-jet	
Number of cleaning valves	nr	6
Type of cleaning valves	Ø1" - 24 VDC	
Compressed air tank working pressure	bar	5,5
PERFORMANCE CHARACTERISTICS		
Nominal air flow	m ³ /h	5000
Nominal static pressure	Pa	3130
Nominal fan power	kW	7,5
Max compressed air consumption	NI/min	360
Average level of sound pressure LpA_1.5m (UNI EN ISO 3746)	dB(A)	<80

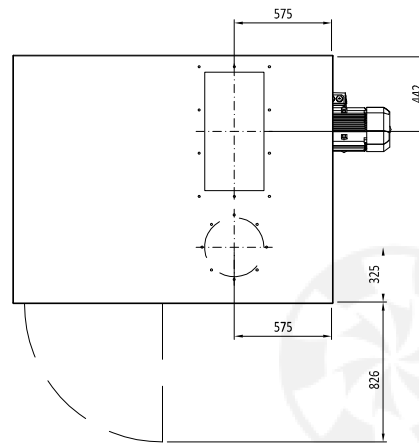
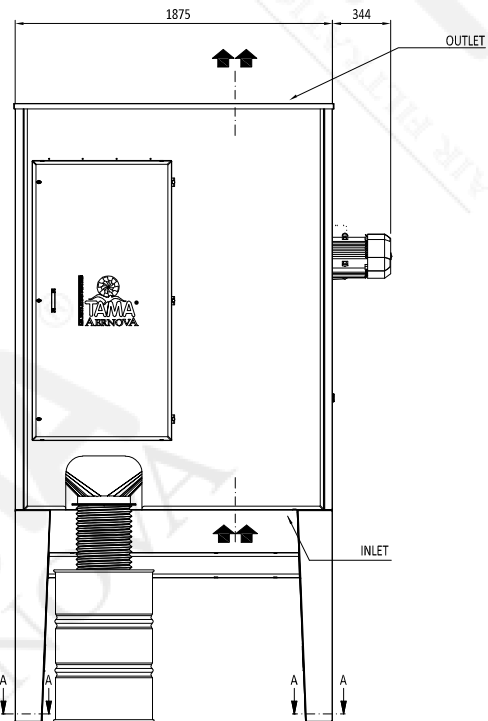
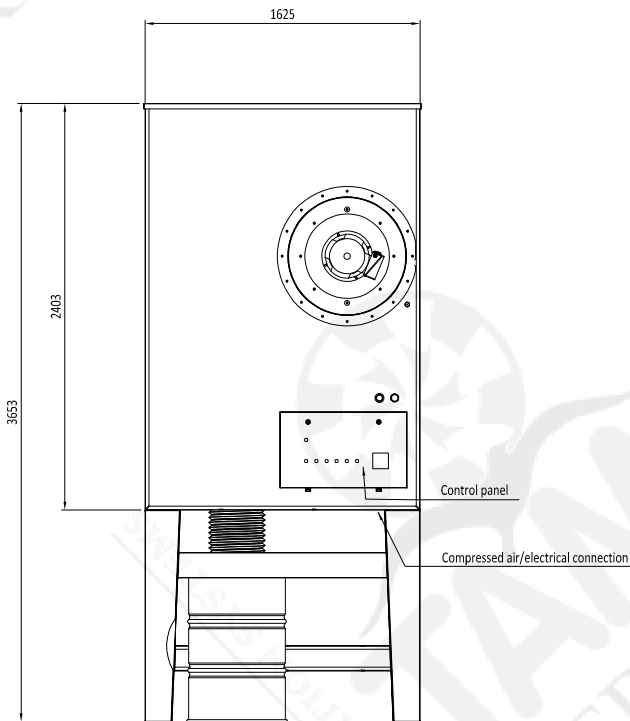

GROUND FASTENING LAYOUT (SECTION A-A)

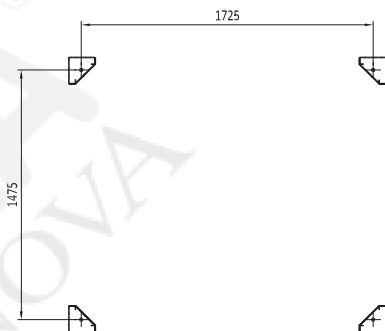

INLET FLANGE DETAIL

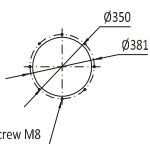

Nr.8 connections to screw M8

OUTLET FLANGE DETAIL

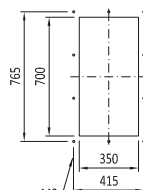

Nr.10 connections to screw M8

TECHNICAL SPECIFICATIONS

ITEM CODE	OPF-R 2x4	
Weight	kg	1600
Number of filtering elements	nr	8
Filtering surface	m ²	168
Filtering efficiency	99,999% on 0,5 micron dust particles	
Max working negative pressure	Pa	5000
Working Temperature	°C	-10 < T < 40
Pneumatic feeding (ISO Class 2.4.1 according 8573-1:2010)	Ø	12
Electric feeding	400 V - 50 Hz	
Cartridge cleaning system	pulse-jet	
Number of cleaning valves	nr	8
Type of cleaning valves	Ø 1" - 24 VDC	
Compressed air tank working pressure	bar	5,5

PERFORMANCE CHARACTERISTICS

Nominal air flow	m ³ /h	6600
Nominal static pressure	Pa	3550
Nominal fan power	kW	11
Max compressed air consumption	NI/min	360
Average level of sound pressure LpA_1.5m (UNI EN ISO 3746)	dB(A)	<80

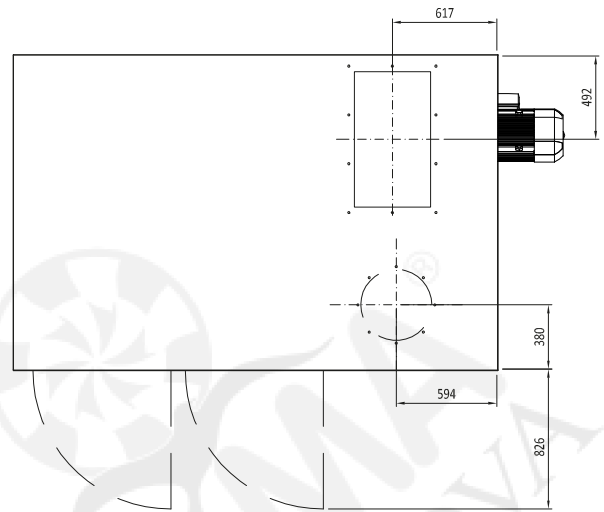
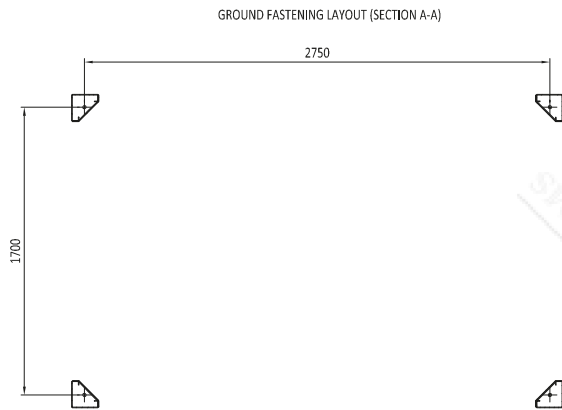
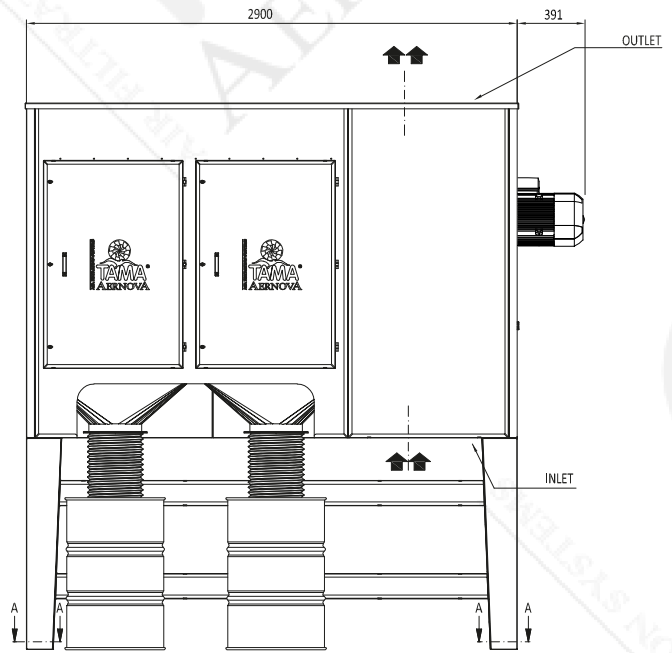
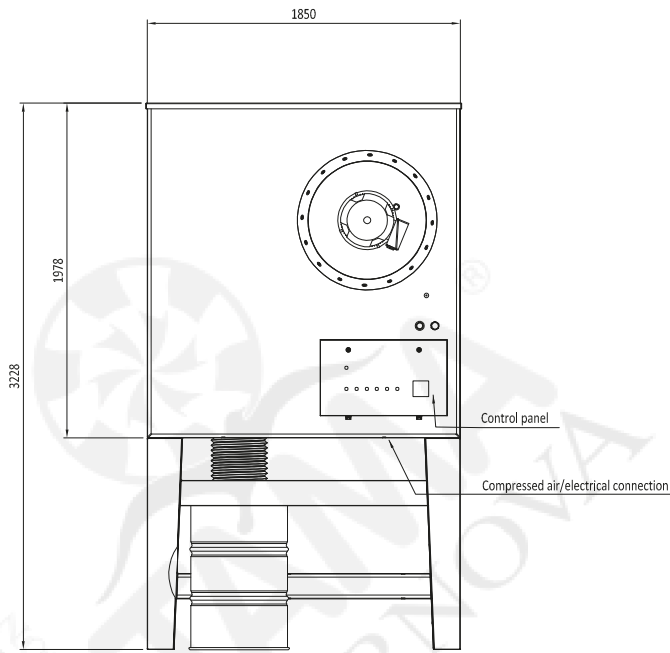

INLET FLANGE DETAIL

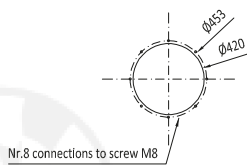

OUTLET FLANGE DETAIL

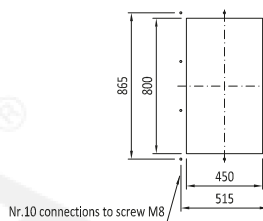

TECHNICAL SPECIFICATIONS			
ITEM CODE	OPF-R 4x3		
Weight	kg	1750	
Number of filtering elements	nr	12	
Filtering surface	m ²	252	
Filtering efficiency	99,999% on 0,5 micron dust particles		
Max working negative pressure	Pa	5000	
Working Temperature	°C	-10 < T < 40	
Pneumatic feeding (ISO Class 2.4.1 according 8573-1:2010)	Ø	12	
Electric feeding	400 V - 50 Hz		
Cartridge cleaning system	pulse-jet		
Number of cleaning valves	nr	12	
Type of cleaning valves	Ø1" - 24 VDC		
Compressed air tank working pressure	bar	5,5	
PERFORMANCE CHARACTERISTICS			
Nominal air flow	m ³ /h	9900	
Nominal static pressure	Pa	3500	
Nominal fan power	kW	15	
Max compressed air consumption	NI/min	360	
Average level of sound pressure LpA_1.5m (UNI EN ISO 3746)	dB(A)	<80	

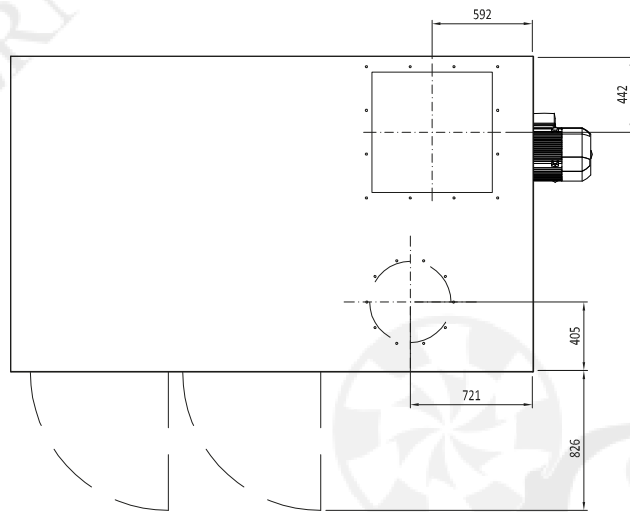
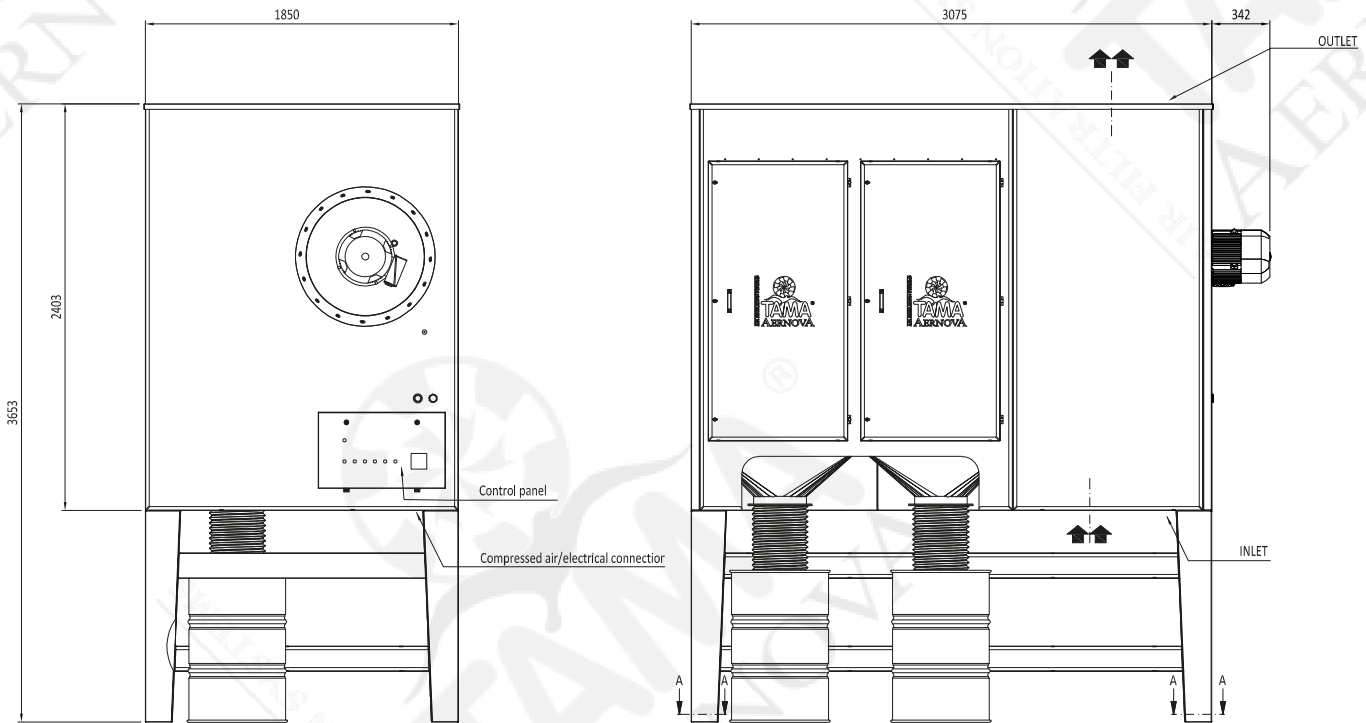

GROUND FASTENING LAYOUT (SECTION A-A)



INLET FLANGE DETAIL

OUTLET FLANGE DETAIL

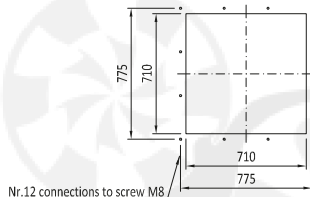
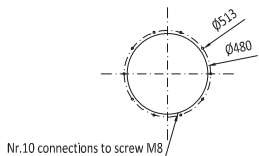

TECHNICAL SPECIFICATIONS		
ITEM CODE	OPF-R 4x4	
Weight	kg	2100
Number of filtering elements	nr	16
Filtering surface	m ²	336
Filtering efficiency	99,999% on 0,5micron dust particles	
Max working negative pressure	Pa	5000
Working Temperature	°C	-10<T<40
Pneumatic feeding (ISO Class 2.4.1 according 8573-1:2010)	Ø	12
Electric feeding	400 V - 50 Hz	
Cartridge cleaning system	pulse-jet	
Number of cleaning valves	nr	16
Type of cleaning valves	Ø1" - 24 VDC	
Compressed air tank working pressure	bar	5,5
PERFORMANCE CHARACTERISTICS		
Nominal air flow	m ³ /h	13200
Nominal static pressure	Pa	3600
Nominal fan power	kW	18,5
Max compressed air consumption	NI/min	360
Average level of sound pressure LpA_1.5m (UNI EN ISO 3746)	dB(A)	<80