

PrimeLine™ Syringe Pumps

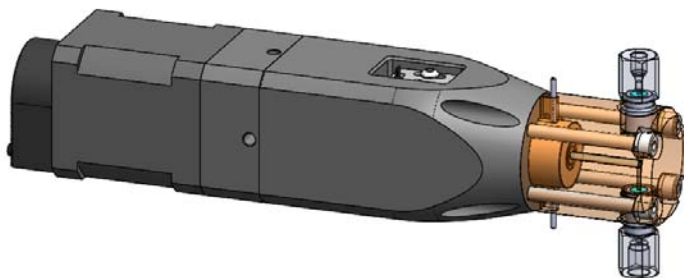

Features

- Spring loaded check valves allow operation in horizontal or vertical mounting orientation
- Graphical user interface via USB connection
- Wash seal option for pumping buffers
- Stepper motor with drive/controller
- Available with high pressure stainless steel
- OEM & material options are available
- Modbus RTU, RS485 serial communications protocol for OEM software control



ASI

ASI Model 576 Syringe Pumps outperformed competitors in head-to-head engineering trials. Flow precision, was closed as the critical evaluation metric by an independent engineering team. ASI was best-in-class for low flow ($\mu\text{L}/\text{min}.$) for pressures up to 9,000 PSI. Applications requiring such high precision includes: HPLC, LCMS, Sampling systems, Metering liquids and Sample preparation.

Unmatched flow precision at high pressure make the ASI 576 Syringe Pump the top choice for design engineers.

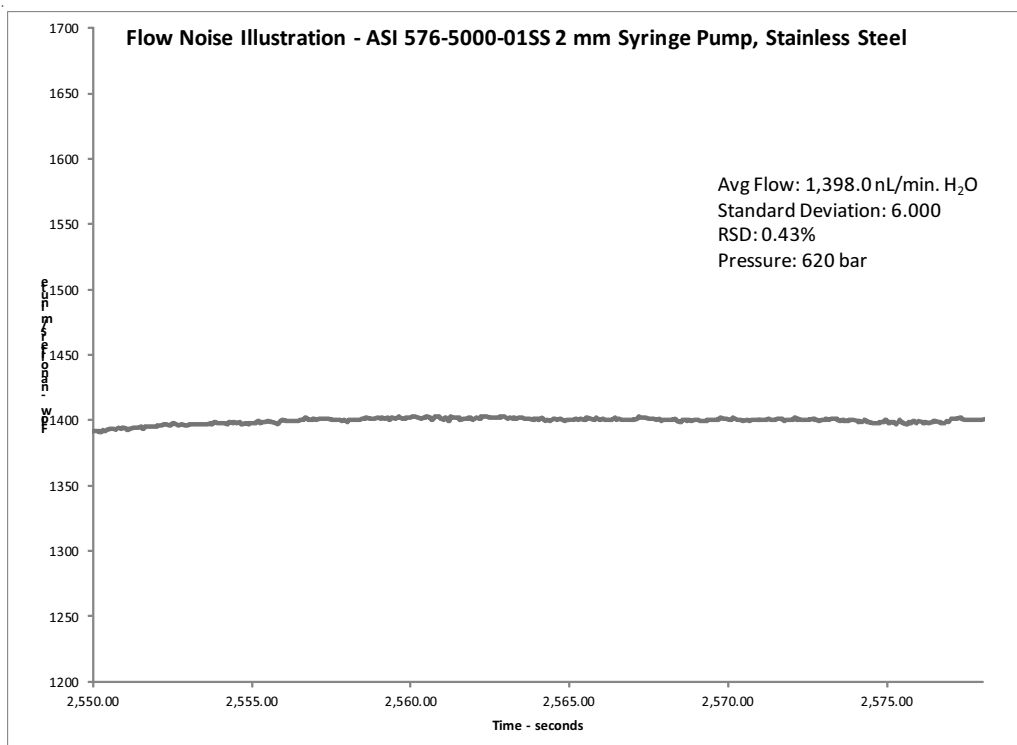
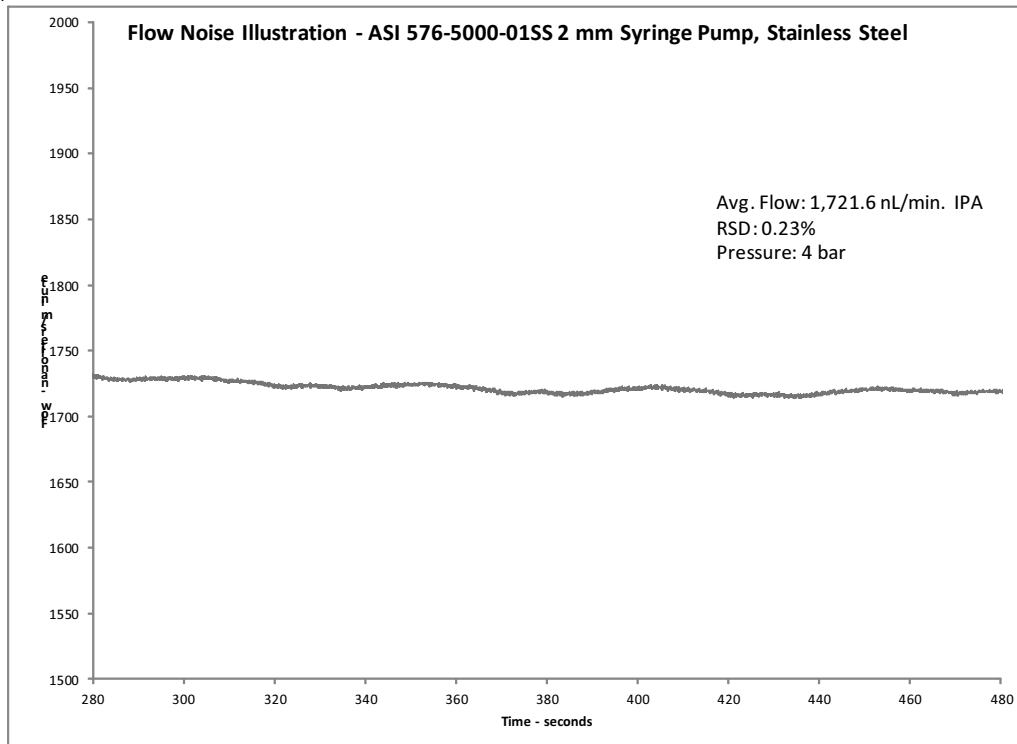

Competitor #1

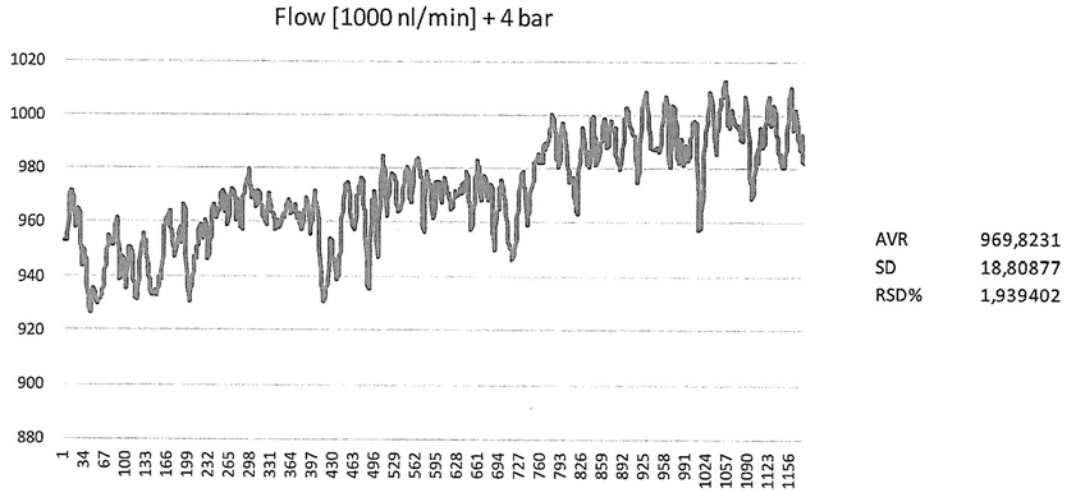

Competitor #2

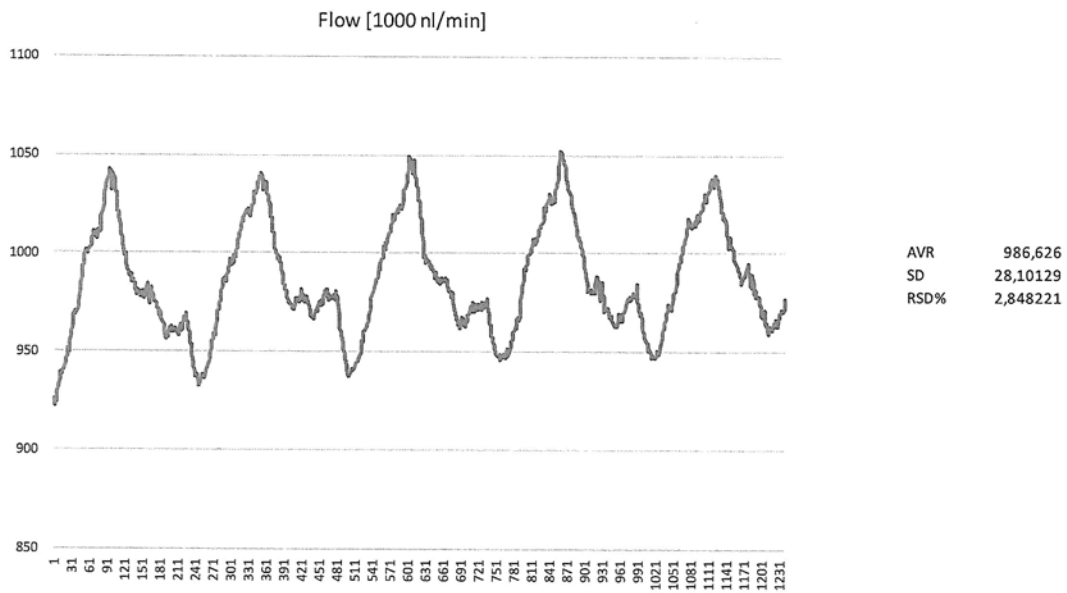

Specifications

Motor Description:

NEMA 17 triple stack step motor - pump controller with motor drive & controller

Power:

100 - 240 VAC, 50 - 60 Hz, 1 A Max

OEM Power Option:

24 VDC, 3A Max

Operating Temperature:

4 - 40° C

Dimensions:

13.75" L x 3" W x 4.1" H (with cover)



Standard Check Valve Configuration

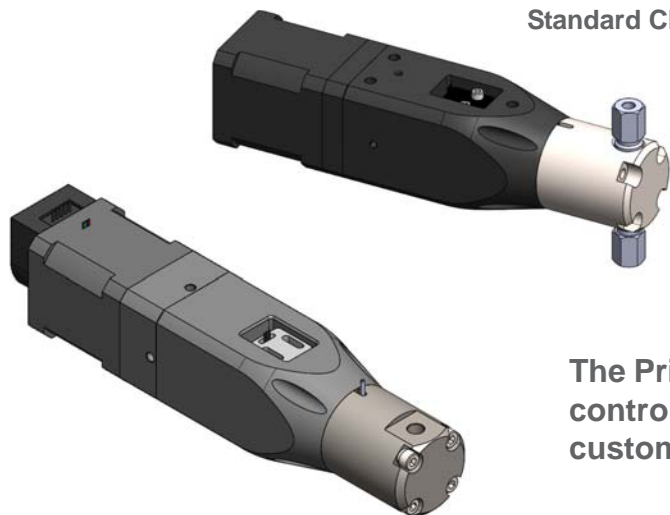

The PrimeLine Syringe Pump without integral drive/controller for stepper motor, check valves or other custom features are available, please contact us.

Single Port and Encoder options

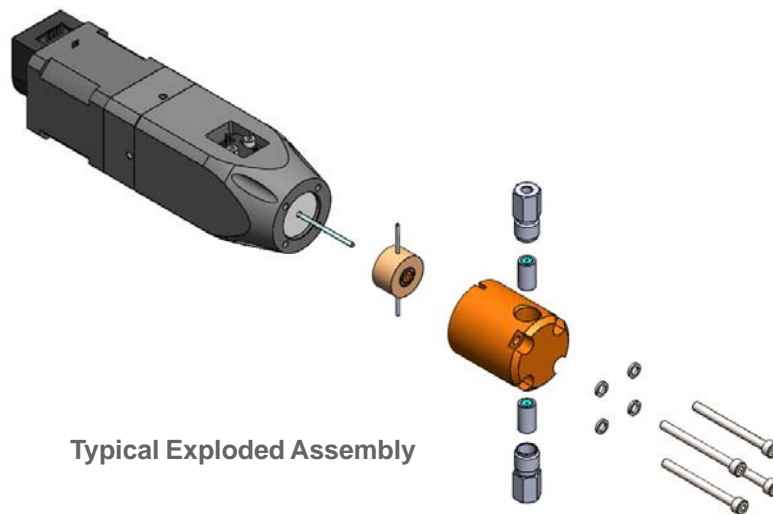

Typical Exploded Assembly

OEM Inquiries are welcome!

Analytical Scientific Instruments US, Inc.
3023 Research Drive Richmond CA 94806 USA
www.hplc-asi.com Phone: 510-669-2250 info@hplc-asi.com

