

**Magnetek**  
ELECTROBAR® ELITE  
Conductor Bar System



# ELECTROBAR<sup>®</sup> ELITE

## ENCLOSED CONDUCTOR BAR SYSTEMS

Magnetek proudly offers ELECTROBAR<sup>®</sup> Elite, our most advanced conductor bar system. The collector trolley and conductors are captured inside the line element extrusion and can't be disengaged. The collector trolley is advanced with a chain which tolerates large movements lateral to the direction of motion. The system is simple to install, with only one "stick" to hang and align.

### LOWER TOTAL SYSTEM COST — EASY TO INSTALL AND MAINTAIN

- Electrobar Elite reduces installation time when compared with traditional conductor bar systems. Maintenance requirements are minimized, providing lower installation and lifetime maintenance costs.
- System components are lightweight and rigid, allowing a single person to assemble the system.
- Line elements are easily slipped into the snap-in hangers, which mount with one threaded rod to the hanger bracket.
- Joint covers, power feeds and end caps simply snap together over the line elements. Much of the assembly is done by hand, using a minimum number of tools.
- Line elements are connected with torque limiting bolts whose heads twist off when enough torque has been applied. This assures proper connection of conductors with smooth transitions from section to section for the collector brushes.
- Collector brushes are normally serviced by removing the trolley from the end of the system. The brushes are easy to remove and put back into the trolley, allowing a rapid return to service after maintenance. The collector assembly can only be put back into the line element in one orientation, preventing cross connecting power and ground.

### MAXIMUM VERSATILITY

- Compact design allows installation in tight spaces where other systems will not fit.
- No expansion joints are required in systems under 460 feet.
- Low friction collectors ease movement of workstation bridge cranes.
- IP23 rated so it is finger safe and resistant to rain at up to a 60 degree angle from vertical.
- Rubber dust exclusion strips are available to minimize contamination of conductors through the line element trolley gap.
- High speed collectors available for speeds exceeding 325 fpm.
- Standard line element operating temperature range -20°C to 55°C.
- High temperature line elements available for temperatures above 55°C to 75°C.
- Curved elements available with minimum 32" radius.
- Ventilated line elements prevent condensation build up.
- Trolley introduction gates ease maintenance of collector trolleys when three or more bridges are used on a single crane runway.

Many parts of the Electrobar Elite system are made from plastic insulating materials. The insulating covers for normal temperature use are made of PVC, the plastic hangers are made from thermoplastic materials as are the plastic parts of the collectors. If your application uses materials or chemicals that can evaporate or get into the air and onto the conductor bar parts, please consult with Magnetek about the suitability of this product in your environment.

# LINE ELEMENTS

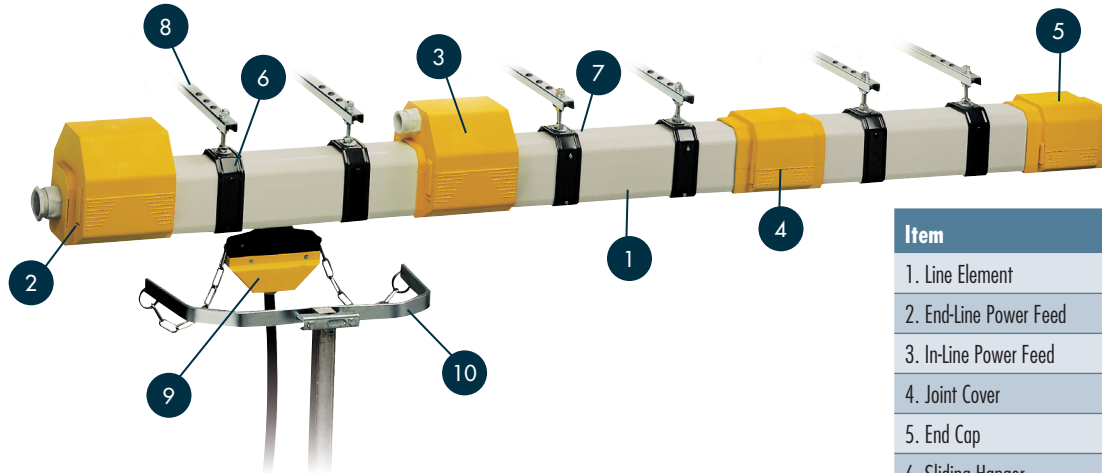

Item	Page Number
1. Line Element	3
2. End-Line Power Feed	4
3. In-Line Power Feed	4
4. Joint Cover	4
5. End Cap	4
6. Sliding Hanger	5
7. Anchor Hanger	5
8. Mounting Bracket	5
9. Collector	6
10. Tow Bracket	6
11. Dust Exclusion Seals (pictured pg. 7)	7
12. Transfer Funnels (pictured pg. 7)	7
13. Expansion Element (pictured pg. 8)	8

## STANDARD FEATURES & BENEFITS

- Operating temperature range -20°C to 55°C.
- Collector trolley captured by line element and can't be disengaged.
- Snap together covers, power feeds and hangers.
- Lightweight, rigid construction.
- Ease of installation, lower total system cost, and low maintenance.
- Improved safety (finger safe rating of IP23).

## 1. 4-POLE AND 5-POLE LINE ELEMENTS

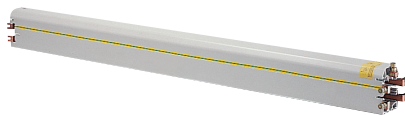

- Line Elements are constructed of self-extinguishing PVC with copper conductors. 20 Amp Line elements use steel conductors.
- Maximum rated operational voltage 600 volts, 460V for high temperature line elements.

### 4-POLE LINE ELEMENTS

Catalog Number	Description	Length		Weight Lbs.
		Meters	Feet	
FM-4204	20 Amp, 4-Pole Line Element	4	13.123	15.00
FM-4203		3	9.843	11.25
FM-4202		2	6.562	7.50
FM-4201		1	3.281	3.75
FM-4604	60 Amp, 4-Pole Line Element	4	13.123	15.88
FM-4603		3	9.843	11.91
FM-4602		2	6.562	7.94
FM-4601		1	3.281	3.97
FM-4104	100 Amp, 4-Pole Line Element	4	13.123	17.64
FM-4103		3	9.843	13.23
FM-4102		2	6.562	8.82
FM-4101		1	3.281	4.41
FM-4134	130 Amp, 4-Pole Line Element	4	13.123	21.16
FM-4133		3	9.843	15.87
FM-4132		2	6.562	10.58
FM-4131		1	3.281	5.29
FM-8284-TR	200 Amp, 4-Pole Line Element	4	13.123	31.72
FM-8283-TR		3	9.843	23.79
FM-8282-TR		2	6.562	15.86
FM-8281-TR		1	3.281	7.93

### 5-POLE LINE ELEMENTS

Catalog Number	Description	Length		Weight Lbs.
		Meters	Feet	
FM-5204	20 Amp, 5-Pole Line Element	4	13.123	15.88
FM-5203		3	9.843	11.91
FM-5202		2	6.562	7.94
FM-5201		1	3.281	3.97
FM-5604	60 Amp, 5-Pole Line Element	4	13.123	16.76
FM-5603		3	9.843	12.57
FM-5602		2	6.562	8.38
FM-5601		1	3.281	4.19
FM-5104	100 Amp, 5-Pole Line Element	4	13.123	18.48
FM-5103		3	9.843	13.86
FM-5102		2	6.562	9.24
FM-5101		1	3.281	4.62
FM-5134	130 Amp, 5-Pole Line Element	4	13.123	23.80
FM-5133		3	9.843	17.85
FM-5132		2	6.562	11.90
FM-5131		1	3.281	5.95
FM-8285-TR	200 Amp, 5-Pole Line Element	4	13.123	37.04
FM-8289-TR		3	9.843	27.78
FM-8286-TR		2	6.562	18.52
FM-8287-TR		1	3.281	9.26

# SYSTEM COMPONENTS

## 2. & 3. POWER FEEDS

Designed to feed power to the system either from the end or along the line element run.

Allows for quick power connection with a snap together cover.

Power feed selection based upon location and power feed cord diameter.

### END-LINE POWER FEED

Catalog Number	Description	Cable Dia. In.	Weight Lbs.
FM-1200	20-100 Amp, 4 & 5-Pole, M25 Cable Grip	0.51 to 0.75	0.9
FM-1230	20-100 Amp, 4 & 5-Pole, M32 Cable Grip	0.59 to 0.98	0.9
FM-1250	20-100 Amp, 4 & 5-Pole, M40 Cable Grip	0.83 to 1.25	0.9



End-Line Feed Box

### IN-LINE POWER FEED

Catalog Number	Description	Cable Dia. In.	Weight Lbs.
FM-1300	20-100 Amp, 4 & 5-Pole, M25 Cable Grip	0.51 to 0.75	0.66
FM-1330	20-100 Amp, 4 & 5-Pole, M32 Cable Grip	0.59 to 0.98	0.66

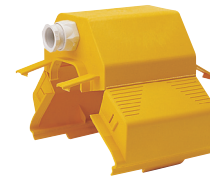

In-Line Feed Box

### IN-LINE POWER FEED WITH JUNCTION BOX

Catalog Number	Description	Cable Dia. In.	Weight Lbs.
FM-1332	20-100 Amp, 4 -Pole, M40 Cable Grip	0.83 to 1.25	3.75
FM-1329	20-100 Amp, 5 -Pole, M40 Cable Grip	0.83 to 1.25	3.75



In-Line Feed Box with Junction Box

### PRE-FABRICATED POWER FEED ON 1 METER LINE ELEMENT (NOT SHOWN)

Catalog Number	Description	Cable Dia. In.	Weight Lbs.
FM-1313	130 Amp, 4-Pole with 2 Meter Connecting Cables	0.63	17.6
FM-8299-TR	200 Amp, 4-Pole with 2 Meter Connecting Cables	0.81	28.6
FM-1317	130 Amp, 5-Pole with 2 Meter Connecting Cables	0.63	19.8
FM-8294-TR	200 Amp, 5-Pole with 2 Meter Connecting Cables	0.81	34.32

## 4. JOINT COVER

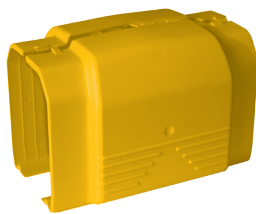

Self centering, snap-on joint cover, no tools required for assembly.

Catalog Number	Description	Weight Lbs.
FM-2000	Joint Covering Flange for All Systems	0.44

## 5. END CAP



Snaps over the end of a line element and includes end stop to prevent over travel of collector.

Catalog Number	Description	Weight Lbs.
FM-2400	End Cap for All Systems	0.66

# SYSTEMS COMPONENTS

## 6. & 7. MOUNTING HANGERS



Galvanized steel construction and premounted M8 x 60 bolt. Snaps onto line element.

### SLIDING HANGER

Catalog Number	Description	Weight Lbs.
FM-1510	Snap-In Hanger, New Style	0.22
Two (2) required for 20 to 130 Amp, 4 meter line elements. Three (3) required for 200 Amp, 4 meter line elements.		



Anchor Hangers secure the line element to the structure. Galvanized steel construction and premounted M8 x 60 bolt with (2) anchoring screws.

### ANCHOR HANGER

Catalog Number	Description	Weight Lbs.
FM-1500	Anchor Hanger, New Style	0.22
Two (2) anchor hangers required on systems with an expansion.		

## 8. HANGER MOUNTING BRACKETS

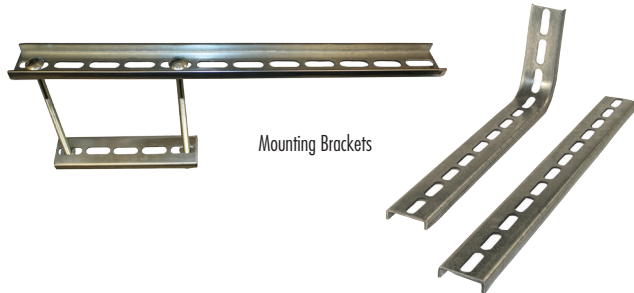

Mounting Brackets

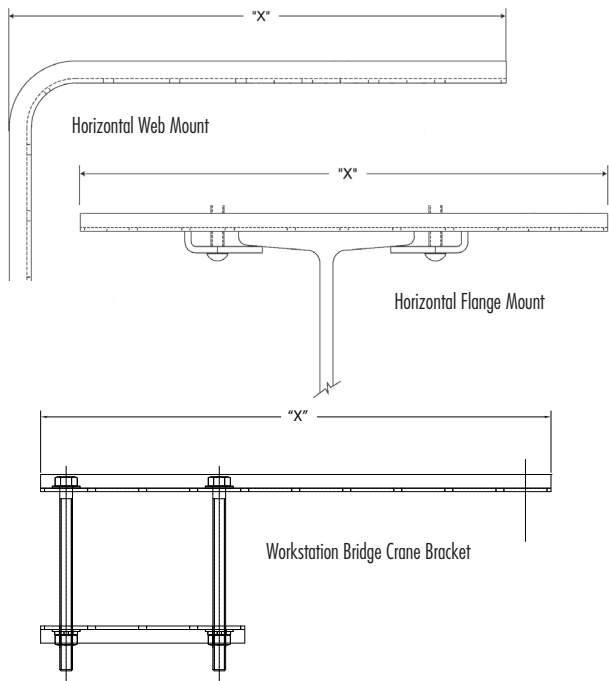

### WEB MOUNTING BRACKETS

Catalog Number	Description	"X" Dimension	Weight Lbs.
BKS-W15-G	Galvanized, Web Mounted, 15 in.	11 in.	1.5
BKS-W18-G	Galvanized, Web Mounted, 18 in.	14 in.	1.9
BKS-W24-G	Galvanized, Web Mounted, 24 in.	20 in.	2.2

### FLANGE MOUNTING BRACKETS

Catalog Number	Description	"X" Dimension	Weight Lbs.
BKS-F18-G	Galvanized, Flange Mounted, 18 in.	18 in.	2.2
BKS-F24-G	Galvanized, Flange Mounted, 24 in.	24 in.	2.7

To order Flange Mount Brackets with two mounting clamps, add "A" after F18 or F24.

### WORKSTATION BRIDGE CRANE MOUNTING BRACKETS

Catalog Number	Description	"X" Dimension	Weight Lbs.
BKS-GBL-2K	Galvanized, for 4 in. x 4 in. tube	15 in.	3.5
BKS-GBL-4K	Galvanized, for 5.5 in. x 4.5 in. tube	18 in.	4.5
BKS-GBL-4K2	Galvanized, for 6 in. x 6 in. tube	18 in.	4.5

# COLLECTOR ASSEMBLIES

## 9. STANDARD (RIGID) COLLECTOR TROLLEY

Collector selection based on amperage requirements.

The collector assembly can be installed only in one orientation to the line element, insuring the ground conductor and the ground collector brush are always together.

The brushes snap into the collector assembly for quick and easy replacement.

Factory stocked collectors come standard with (1) meter of cable and are for systems without curves or dust protection.

### RIGID COLLECTOR TROLLEY FOR 4-POLE SYSTEMS

Catalog Number	Description	Amp Rating	Weight Lbs.
FM-2043-1M	Single Collector Trolley with 1 Meter Cable	40 Amp	1.32
FM-4047-1M	Double Collector Trolley with Two 1 Meter Cables	80 Amp	2.42
FM-5049-1M	Triple Collector Trolley with Three 1 Meter Cables	120 Amp	3.52
FM-4514	Cleaning Collector Trolley (not pictured)		0.88

### RIGID COLLECTOR TROLLEY FOR 5-POLE SYSTEMS

Catalog Number	Description	Amp Rating	Weight Lbs.
FM-2051-1M	Single Collector Trolley with 1 Meter Cable	40 Amp	1.32
FM-4051-1M	Double Collector Trolley with Two 1 Meter Cables	80 Amp	2.42
FM-5059-1M	Triple Collector Trolley with Three 1 Meter Cables	120 Amp	3.52
FM-4525	Cleaning Collector Trolley (not pictured)		0.88

Collectors shown are for standard applications composed of straight line elements. For all other applications, please consult the factory for an application specific quotation.



Single Collector



Double Collector



Triple Collector

### REPLACEMENT PARTS

Catalog Number	Description
FM-0022	Carbon Brush
FM-0118	Brush for Cleaning Collectors

## 10. TOW BRACKETS

Tow Brackets (standard carriers) provide the mechanical link between the collector trolley and the moving equipment.

Galvanized steel brackets to be mounted onto a round tow bar 0.79" (20mm) to 1.97" (50mm) or a square tow bar 0.19" (20mm) to 1.57" (40mm).

Junction boxes are available for tow brackets. Consult the factory.

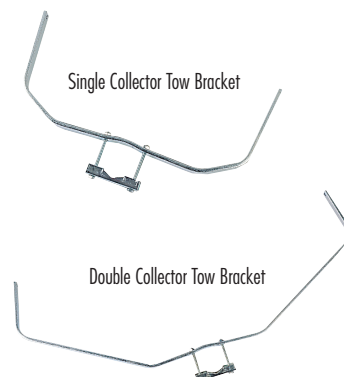

Catalog Number	Description	Weight Lbs.
FM-1600	Tow Bracket for Single Trolley	1.3
FM-1610	Tow Bracket for Double Trolley	2.4
FM-1630	Tow Bracket for Triple Trolley	5.7

# DUST EXCLUSION SEALS

## 11. DUST EXCLUSION SEALS

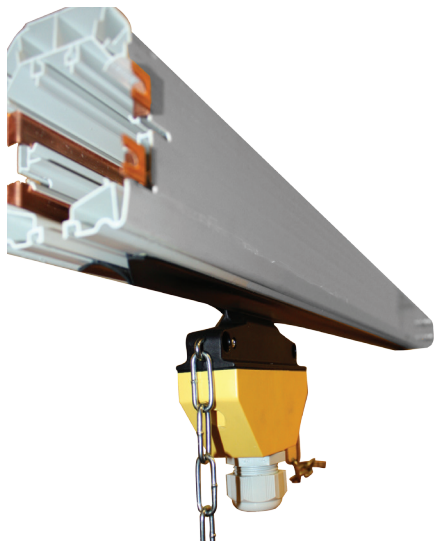

Rubber dust exclusion seals are available for line elements, in-line power feeds, joint covers, curves, trolley inlet gates and expansions. They are not used for end of line components, since the trolley does not pass through them. The catalog number is made by adding a -LV to the end of the standard catalog number. For example, a 20 Amp line element with dust exclusion seals is FM-4204-LV instead of the standard FM-4204. The seals can be added to stocked line elements, which allows good turnaround time for systems requiring dust exclusion. Suitable for use up to 55°C.

Silicone grease is used on the inside of the rubber seals to ease the travel of the collector trolleys.

Catalog Number	Description	Weight Lbs.
FM-0287	Dust Seal Grease	0.5

# TRANSFER FUNNELS

## 12. TRANSFER FUNNEL LINE ELEMENTS



- Transfer funnel is pre-mounted on 1 meter line element. Special lengths available upon request.
- Short funnels may be used for switch applications from 0.375" to 1" gap.
- Long funnels may be used when gap distance exceeds 1".
- Special collector trolleys and tow brackets are required. Contact factory.
- Funnels designed to accommodate ground to the right or left.
- IP23 "finger safe" Rated.

### SHORT FUNNEL ASSEMBLIES

Catalog Number	Description	Amp. Rating
FM-2501	4-Pole 1 Meter Element Ground Right	20
FM-2502	4-Pole 1 Meter Element Ground Left	20
FM-2517	4-Pole 1 Meter Element Ground Right	60
FM-2518	4-Pole 1 Meter Element Ground Left	60
FM-2525	4-Pole 1 Meter Element Ground Right	100
FM-2526	4-Pole 1 Meter Element Ground Left	100
FM-2533	4-Pole 1 Meter Element Ground Right	130
FM-2534	4-Pole 1 Meter Element Ground Left	130
FM-2541-TR	4-Pole 1 Meter Element Ground Right	200
FM-2542-TR	4-Pole 1 Meter Element Ground Left	200

### LONG FUNNEL ASSEMBLIES

Catalog Number	Description	Amp. Rating
FM-2551	4-Pole 1 Meter Element Ground Right	20
FM-2552	4-Pole 1 Meter Element Ground Left	20
FM-2567	4-Pole 1 Meter Element Ground Right	60
FM-2568	4-Pole 1 Meter Element Ground Left	60
FM-2575	4-Pole 1 Meter Element Ground Right	100
FM-2576	4-Pole 1 Meter Element Ground Left	100
FM-2583	4-Pole 1 Meter Element Ground Right	130
FM-2584	4-Pole 1 Meter Element Ground Left	130
FM-2591-TR	4-Pole 1 Meter Element Ground Right	200
FM-2592-TR	4-Pole 1 Meter Element Ground Left	200



# EXPANSION ELEMENTS

## 13. EXPANSION ELEMENT



The expansion element is designed to absorb the difference in expansion between the support structure and the electrification line. Expansions are needed in 20 Amp applications longer than 460 feet (140 meters).

Expansions are needed in 60 Amp and 100 Amp applications longer than 494 feet (150 meters).

Expansions are needed in 130 Amp and 200 Amp applications longer than 820 feet (250 meters).

When expansions are used, an extra single collector trolley must be used on each bridge.

### 4-POLE EXPANSION ASSEMBLY

Catalog Number	Description	Standard Length		Weight Lbs.
		Meters	Feet	
FM-8020	4-Pole Expansion Element 20 Amp	2	6.56	14.11
FM-8060	4-Pole Expansion Element 60 Amp	2	6.56	14.33
FM-8100	4-Pole Expansion Element 100 Amp	2	6.56	16.75
FM-8013	4-Pole Expansion Element 130 Amp	2	6.56	19.18
FM-8290-TR	4-Pole Expansion Element 200 Amp	2	6.56	25.13

### 5-POLE EXPANSION ASSEMBLY

Catalog Number	Description	Standard Length		Weight Lbs.
		Meters	Feet	
FM-8520	5-Pole Expansion Element 20 Amp	2	6.56	15.00
FM-8560	5-Pole Expansion Element 60 Amp	2	6.56	15.43
FM-8510	5-Pole Expansion Element 100 Amp	2	6.56	18.07
FM-8513	5-Pole Expansion Element 130 Amp	2	6.56	21.60
FM-8291-TR	5-Pole Expansion Element 200 Amp	2	6.56	28.88

For more information, contact Magnetek Material Handling or your local Magnetek Sales Representative.

N49 W13650 Campbell Drive  
Menomonee Falls, WI 53051  
Toll-Free Phone 800.288.8178  
Toll-Free Fax 800.298.3503  
Phone 262.783.3500  
Fax 262.783.3510

Canada Facility  
4090B Sladeview Crescent  
Mississauga, Ontario  
L5L 5Y5 Canada  
Phone 800.792.7253  
Fax 905.828.5707

[WWW.MAGNETEKMH.COM](http://WWW.MAGNETEKMH.COM)