

Spindle ball bearings (HY)* SM 61901 C

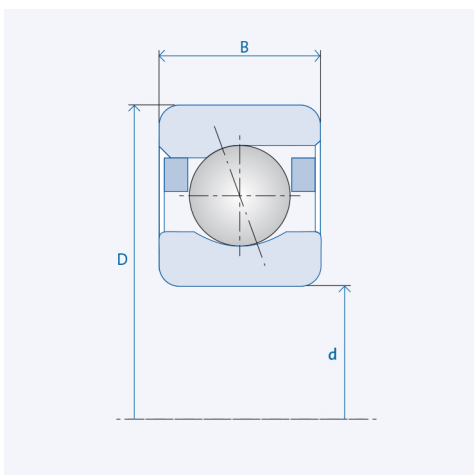

Precision class P4 / ABEC7

Components

Bearing designation:	(HY)* SM 61901 C
Bearing design:	SM
Series / size:	61901
Ball material:	Steel 100Cr6
Ball material HY :	Ceramic Si3N4
Cage:	TA (TXM available upon request)
Precision:	P4 (HG, UP, P2 upon request)
Main dimensions [d x D x B]:	12 x 24 x 6 mm

Technical data (Standard bearings)

Static load capacity C_0 :	990
Dynamic load capacity C:	2330
Speed limit n_{Fett} :	86250
Speed limit n_{Oj} :	115000

Technical data (Hybrid bearings)*

Static load capacity C_{0HY} :	695
Dynamic load capacity C_{HY} :	2330
Speed limit n_{Fett} :	107812.5
Speed limit n_{Oj} :	143750

Pre-tension

Light (L):	12 N
Axial rigidity (C_{ax}):	13 N/ μ m
Medium (M):	35 N
Axial rigidity (C_{ax}):	19 N/ μ m
Heavy (S):	70 N
Axial rigidity (C_{ax}):	26 N/ μ m
Spring preload (Ff):	70 N

The given speed limits apply to individual bearings with spring preload. Correction factors must be considered for all properties which deviate from this.

* All ball bearings are also available as hybrid ball bearings (HY).