

# Spindle ball bearings (HY)\* KH 6005 E

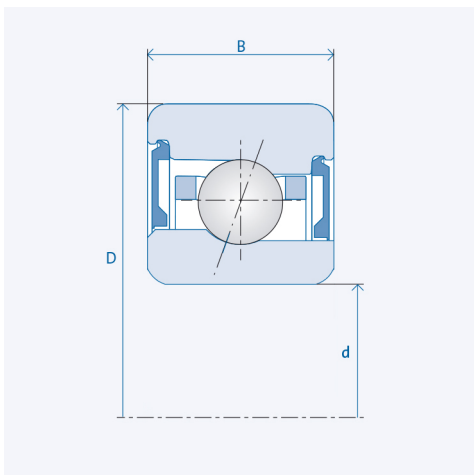

## Precision class P4 / ABEC7

### Components

Bearing designation:	(HY)* KH 6005 E
Bearing design:	KH
Series / size:	6005
Ball material:	Steel 100Cr6
Ball material HY :	Ceramic Si3N4
Cage:	TA (TXM available upon request)
Seal:	2RZ upon request
Precision:	P4 (HG, UP, P2 upon request)
Main dimensions [d x D x B]:	25 x 47 x 12 mm

### Technical data (Standard bearings)

Static load capacity $C_0$ :	3750
Dynamic load capacity C:	7100
Speed limit $n_{Fett}$ :	39750
Speed limit $n_{Oj}$ :	53000

### Technical data (Hybrid bearings)\*

Static load capacity $C_{0HY}$ :	2650
Dynamic load capacity $C_{HY}$ :	7100
Speed limit $n_{Fett}$ :	49687.5
Speed limit $n_{Oj}$ :	66250

### Pre-tension

Light (L):	60 N
Axial rigidity ( $C_{ax}$ ):	65 N/ $\mu$ m
Medium (M):	180 N
Axial rigidity ( $C_{ax}$ ):	96 N/ $\mu$ m
Heavy (S):	360 N
Axial rigidity ( $C_{ax}$ ):	125 N/ $\mu$ m
Spring preload (Ff):	340 N

The given speed limits apply to individual bearings with spring preload. Correction factors must be considered for all properties which deviate from this.

\* All ball bearings are also available as hybrid ball bearings (HY).