

Spindle ball bearings (HY)* KH 61901 C

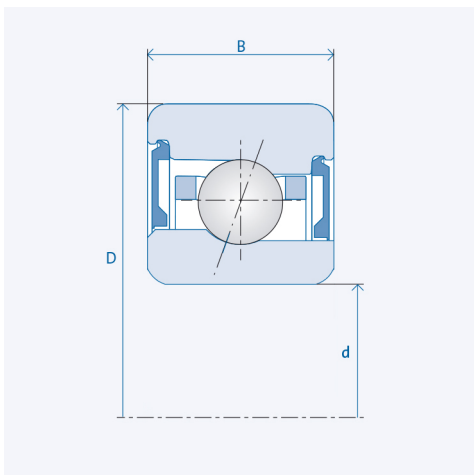

Precision class P4 / ABEC7

Components

Bearing designation:	(HY)* KH 61901 C
Bearing design:	KH
Series / size:	61901
Ball material:	Steel 100Cr6
Ball material HY :	Ceramic Si3N4
Cage:	TA (TXM available upon request)
Seal:	2RZ upon request
Precision:	P4 (HG, UP, P2 upon request)
Main dimensions [d x D x B]:	12 x 24 x 6 mm

Technical data (Standard bearings)

Static load capacity C_0 :	650
Dynamic load capacity C:	1480
Speed limit n_{Fett} :	90000
Speed limit n_{Oj} :	120000

Technical data (Hybrid bearings)*

Static load capacity C_{0HY} :	455
Dynamic load capacity C_{HY} :	1480
Speed limit n_{Fett} :	112500
Speed limit n_{Oj} :	150000

Pre-tension

Light (L):	7 N
Axial rigidity (C_{ax}):	12 N/ μ m
Medium (M):	22 N
Axial rigidity (C_{ax}):	19 N/ μ m
Heavy (S):	45 N
Axial rigidity (C_{ax}):	26 N/ μ m
Spring preload (Ff):	55 N

The given speed limits apply to individual bearings with spring preload. Correction factors must be considered for all properties which deviate from this.

* All ball bearings are also available as hybrid ball bearings (HY).