

LP-Series

Drop-In Replacement Low Profile Pancake Load Cells

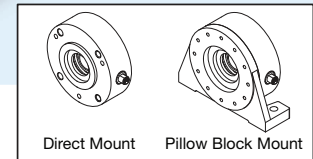

**NEW
PRODUCT
2019**



Montalvo LP Series Low Profile Pancake Load Cells

Drop-in replacement low profile pancake load cells featuring Montalvo's superior signal, superior construction, and superior reliability load cell technology. Our LP Series load cells are the ideal load cells for applications with narrower machine frames requiring a compact load cell. Our higher performance, higher accuracy, and higher durability load cells are available in three sizes with several bearing options for each size, a wide range of load ratings, and versatile mounting options to meet existing bolt patterns. Ideal as a drop-in replacement for existing applications requiring improved tension control performance or new installations looking to start with Better Web Control. The LP series delivers.

Features

- ▶ Versatile and compact - mount directly inside or outside machine frame or use mounting supports
- ▶ Hard stops - factory set for optimum protection and repeatability
- ▶ Overload protection 10+ times nominal load
- ▶ Stainless steel construction
- ▶ High degree of linearity and repeatability
- ▶ Wide load ranges
- ▶ Full bridge foil gauge measuring beam
- ▶ Thru-shaft option
- ▶ Multiple bearing options

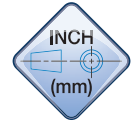

Dimensions - Load Cell

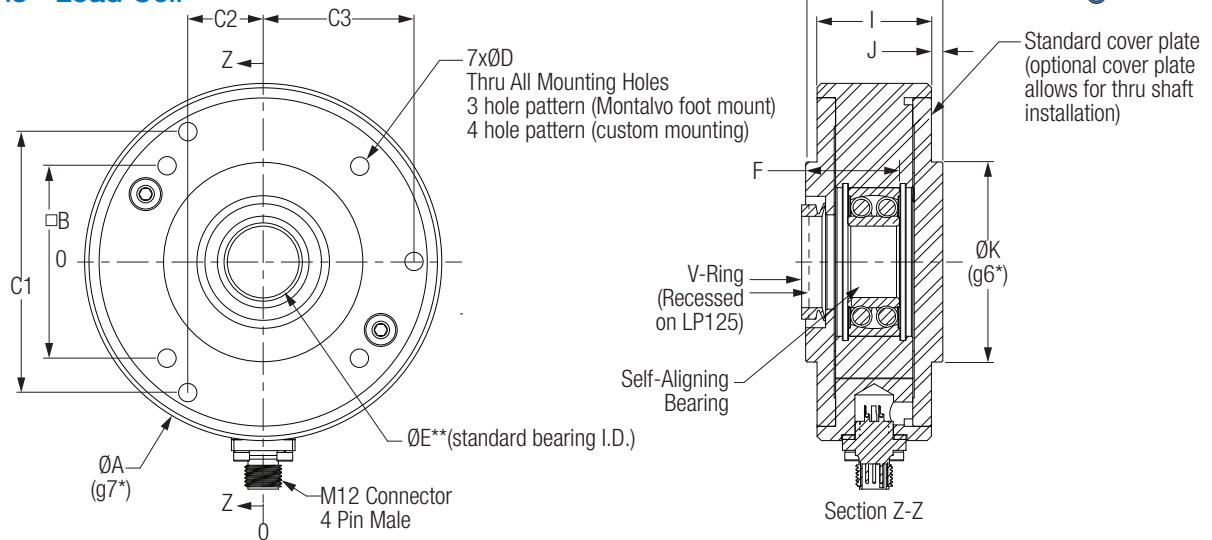

	A*	B	C1	C2	C3	D	E**	F	H	I	J	K*	V-Ring
LP-105	4.1339 (105)	2.088 (53)	3.068 (78)	0.886 (22.5)	1.772 (45)	0.260 (6.60)	0.669 (17)	0.984 (25)	1.496 (38)	1.260 (32)	0.118 (3)	2.362 (60)	$\begin{matrix} -0.000 \\ -0.001 \\ -0.010 \\ -0.028 \end{matrix}$ VA22
LP-125	4.9213 (125)	2.644 (67.2)	3.58 (91)	1.033 (26.2)	2.067 (52.5)	0.260 (6.60)	0.984 (25)	1.263 (32)	1.890 (48)	1.575 (40)	0.157 (4)	2.756 (70)	$\begin{matrix} -0.000 \\ -0.001 \\ -0.01 \\ -0.03 \end{matrix}$ VA32
LP-175	6.890 (175)	3.758 (95.46)	5.114 (129.9)	1.476 (37.50)	2.953 (75)	0.354 (9)	1.378 (35)	1.723 (43.75)	2.54 (64.50)	2.24 (56.5)	0.15 (4)	3.937 (100)	$\begin{matrix} -0.01 \\ -0.01 \\ -0.013 \\ -0.036 \end{matrix}$ VA45

* Note that g6 and g7 are ISO tolerances.

**Optional bearings available. See "Specifications" page.

Dimensions - Pillow Block Mount

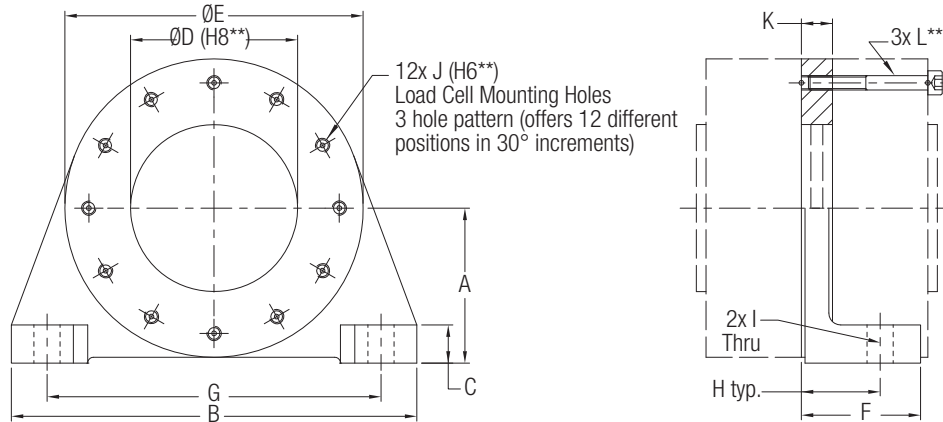

	A	B	C	D**	E	F	G	H	I	J**	K	L***
LP-105	2.756 (70)	6.10 (155)	0.51 (13)	2.362 (60)	4.252 (108)	1.77 (45)	4.72 (120)	1.181 (30)	0.492 (12.5)	M6x1.0	0.512 (13)	M6x1.0x45
LP-125	2.953 (75)	6.850 (174)	0.571 (14.5)	2.756 (70)	5.00 (127)	1.969 (50)	5.512 (140)	1.181 (30)	0.472 (12)	M6x1.0	0.394 (10)	M6x1.0x50
LP-175	4.207 (107)	8.811 (224)	0.709 (18)	3.937 (100)	7.087 (180)	2.762 (70.2)	7.480 (190)	1.847 (47)	0.61 (15.5)	M8x1.25	0.602 (15.3)	M8x1.25x70

** Note that 6H and H8 are ISO tolerances.

*** Mounting bolts are customer supplied.

How to Specify

Series-Size

LP-105, LP-125 or LP-175

Consider the following:

- Dimensions
- Bearing Size
- Load Rating
- Replacement Mounting

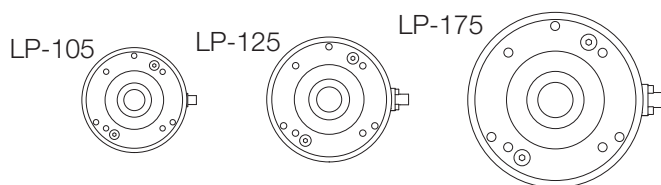

See Dimensions Page

Bearing I.D. (mm)

LP-105 17 (std.), 15, 12
 LP-125 25 (std.), 25T, 20
 LP-175 35 (std.), 40

Pick a bearing based on the diameter of the shaft

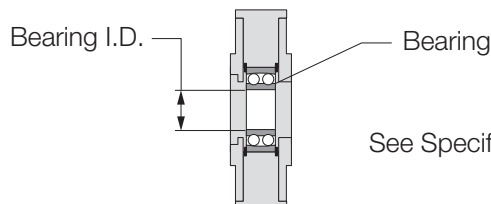

See Specifications Page for More Information

Load Rating lb (N)

LP-105 10 (50) / 25 (125) / 50 (250) / 100 (500) / 200 (1000)
 LP-125 25 (125) / 40 (200) / 75 (375) / 150 (750) / 300 (1500)
 LP-175 75 (375) / 150 (750) / 300 (1500) / 600 (3000)

- LR load rating
- P maximum tension (pull) on web
- B wrap angle
- W weight of roller in pounds
- A angle between F_t and vertical axis
- C angle between entering and exiting web
- F resultant force

F_t points ABOVE horizon

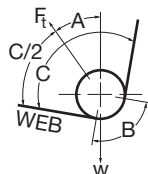

$$LR = \frac{4P \sin(B/2) - W \cos(A)}{2}$$

F_t points BELOW horizon

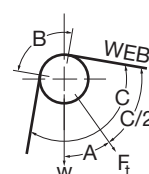

$$LR = \frac{4P \sin(B/2) + W \cos(A)}{2}$$

F_t is HORIZONTAL

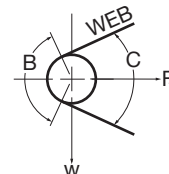

$$LR = \frac{4P \sin(B/2)}{2}$$

Note: It is recommended that Montalvo be contacted to ensure proper sizing.

Connector Position

- 6 o'clock (standard)
- 3/9 or 12 (available upon request)
- Position is relative to LOAD DIRECTION

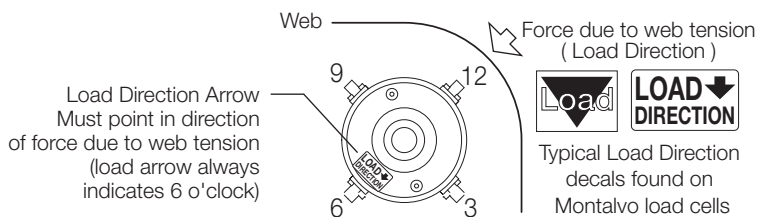

Cover

C or O

C (closed)

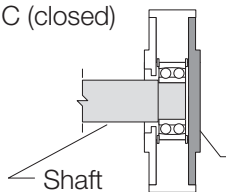

Closed Cover Plate - protects bearing

O (open)

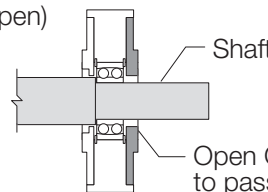

Open Cover Plate - allows shaft to pass thru load cell

Mount

S or P

S (standard)

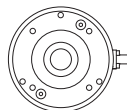

P (pillow block)

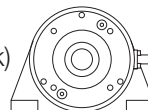

Example

LP125 - 20 - 750N - 6 - O - P

Series-Size
 Bearing
 Load

Mount
 Cover
 Connector Position

(include unit of measure (N or lb))

EST. 1947

montalvo

Better Web Control®

1-800-226-8710 / info@montalvo.com / www.montalvo.com

Technical details subject to change without notice. LP-US-05 © Montalvo

How It Works

The Montalvo LP-Series Load Cell is a one piece tension measuring transducer equipped with a self aligning ball bearing which allows both misalignment and axial movement of a sensing roller. Foil gauges are mounted on each side of the measuring beam and connected in a full bridge configuration. Web tension on the sensing roller bends the beams slightly thus deflecting the gauges. This produces an analog output proportional to the web tension. The load cell output is zero and gain calibrated.

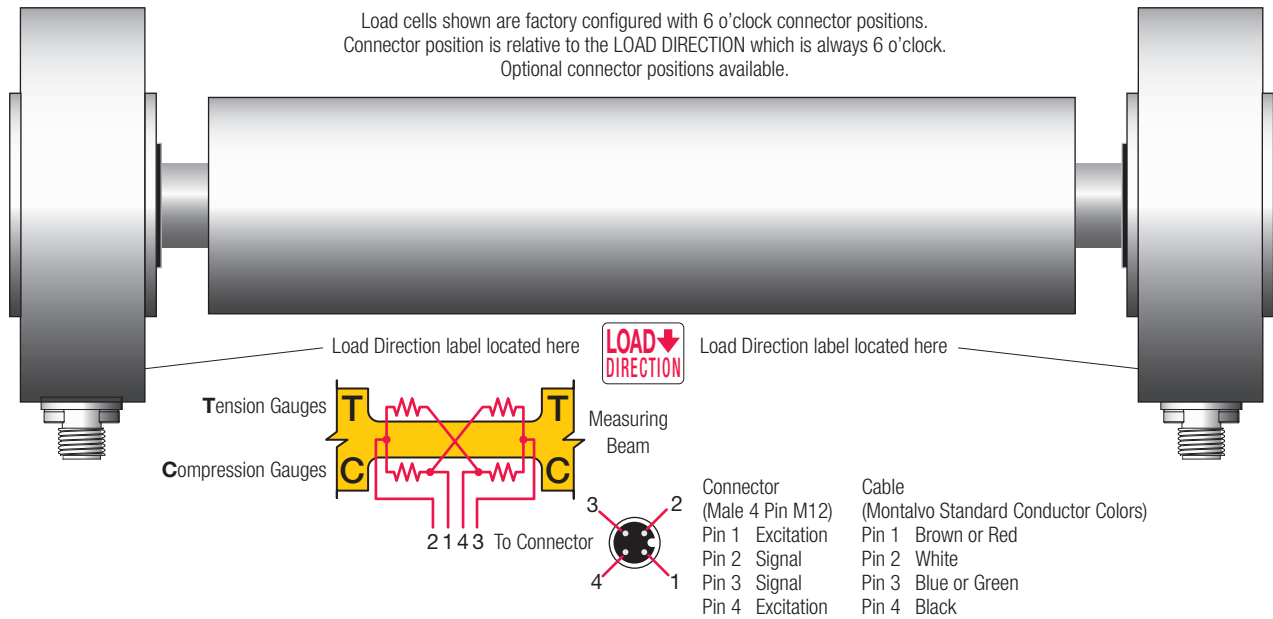

Specifications

Excitation 10 VDC
 Output..... 1mV/V, nominal @ full load
 Gauge Resistance..... 350 Ω
 Gauge Type full bridge foil
 Non-Repeatability..... ±1/4% full span
 Non-Linearity and Hysteresis (combined) ±1/2% full span
 Nominal Force F_{nom} lb (N)
 LP-105 10 (50) / 25 (125) / 50 (250) / 100 (500) / 200 (1000)
 LP-125 25 (125) / 40 (200) / 75 (375) / 150 (750) / 300 (1500)
 LP-175 75 (375) / 150 (750) / 300 (1500) / 600 (3000)
 Note: It is recommended that Montalvo be contacted to ensure proper sizing.
 Overload..... 10 x load rating
 Overload Stop Engagement 110-130% of full load
 Overload Protection (Axial)..... 0.2 x full load
 Connector Position..... 6 (Standard) (3/9 or 12 o'clock option)
 Amplifier (recommended) Montalvo M3300 or M3324

Classification IP54 (IP67 option)
 Temperature °F (°C)
 Operating Range..... -4 to +150 (-20 to +70)
 Coefficient (% per degree) 0.02 (0.01) typ.

Mechanical
 Deflection in (mm)..... 0.004 to 0.012 (0.1 to 0.3)
 Alignment..... 1° max.
 Material..... stainless steel
 Bearings* (Self Aligning) mm ID x OD x W
 LP-105 17 Standard..... 17 x 40 x 12
 15 Option 15 x 35 x 11
 12 Option 12 x 32 x 10
 LP-125 25 Standard..... 25 x 52 x 18
 25T (thin) Option 25 x 52 x 15 (with shims)
 20 Option 20 x 52 x 15 (with shims)
 LP-175 35 Standard..... 35 x 80 x 21 (with shims)
 40 Option 40 x 80 x 23

*Customer specified bearings available upon request - contact Montalvo for further information.

	207-856-2501 / 800-226-8710
	+86-21-52188010
	+45 75 57 27 11
	+49 (0)511 760 691 41

The Montalvo Corporation

EST. 1947 **montalvo**
 Better Web Control®

50 Hutcherson Drive, Gorham, Maine 04038 USA
 Fax: 1-800-644-5097 / 207-856-2509

1-800-226-8710 / info@montalvo.com / www.montalvo.com
 Technical details subject to change without notice. LP-US-05 © Montalvo