

Wall and floor standing installation
800 x 600x 400 mm (h x w x d)

6kW cabinets, 1-3 x MHE

OPUS HE 24-4.5 OC0864 F
OPUS HE 48-6.0 OC0864 F
OPUS HE 60-6.0 OC0864 F
OPUS HE 110-6.0 OC0864 F
OPUS HE 125-6.0 OC0864 F
OPUS HE 220-6.0 OC0864 F

12kW cabinets, 1-6 x MHE

OPUS HE 24-9.0 OC0864 F
OPUS HE 48-120 OC0864 F
OPUS HE 60-12.0 OC0864 F
OPUS HE 110-12.0 OC0864 F
OPUS HE 125-12.0 OC0864 F
OPUS HE 220-12.0 OC0864 F

6kW cabinets with Inverters and DC/DC Converters

1-3 x MHE Rectifiers 24-220VDC
1-3 x Inverters / bypass
1-3 x DC/DC Converters
Max 3 slots for INV + DC/DC



Product Description

OPUS HE Power Systems are robust, free convection cooled, N+1 redundant backup power solutions for critical infrastructure applications such as transmission and distribution substations, process industries, railway signalling and telecommunications.

OPUS HE DC power systems consist of MHE rectifiers, VID1+ controllers, Connections for mains and battery and load distribution MCB. System is configurable to meet requirements of the application. On top of 12 configurable relay alarms, system can be remotely monitored via modern communication protocols such as Ethernet TCP/IP, Modbus TCP/IP, SCADA IEC61850, SNMP and RS-232.

OC0864 800x600x400mm standard cabinet systems deliver maximum 12 kW output power at 48, 60, 110, 125 and 220 VDC and 9 kW at 24 VDC output. Cabinets have standard configurations for 3 or 6 rectifier modules and DC/AC inverters or DC/DC converters can be added to the system. Quantity of rectifiers, battery fuses, load distribution and many other features are configurable to match with requirements of the application.

Features

- Efficiency up to 97%
- Convection cooling – no fans
- Outputs 24, 48, 60, 110, 125, 220 VDC
- Flexible design with full front cabling
- VID1+ I/O controller, local and remote interfaces
12 x relays, Ethernet, Modbus, IEC61850, SNMP, RS-232
- Configurable load distribution
- Configurable battery fuses and discharging test
- Options: A+B parallel supply, IP21 roof, BLVD contactor, battery block voltage monitoring, inverters & DC/DC converters
- Safety:
Cabinet: EN61439-1, EN61439-2
Low voltage switchgear controlgear assemblies
Rectifiers: EN 62368-1, EN 50124-1 rail
- EMC:
Cabinet: EN61439-1, EN61439-2
Rectifiers: EN 61000-6-1 / -2 / -3 / -4 / -5
EN 50121-4 rail, ETSI EN 300386 (48/60V)

Technical Specifications

General construction		Environment and standards	
Cooling	Natural convection	Temp. range	-25 ... +60°C, see derating page 5, Start-up at -40°C
Protection	IP 20, Option IP21	Humidity max	95% relative humidity, non-condensing
Controller user interface	Display and local control in front door & web interface	Altitude	Max 3km, full power up to 2km above sea level Derating 2% per 100 m between 2-3km
Cabling	Default top entry Option bottom entry	Safety	Cabinet: EN61439-1, EN61439-2 Rectifiers: EN 62368-1, EN 50124-1 rail
Colour	Frame RAL 7037, door RAL 7024	EMC	Cabinet: EN61439-1, EN61439-2 Rectifiers: EN61000-6-1 / -2 / -3 / -4 Generic EN61000-6-5 Utility EN 50121-4 Rail, ETSI EN 300 386 (48/60V)
Dimensions & weight	Hght 800mm (w/o feet & IP21 roof) Width 600 mm Depth: 400 mm, rectifiers, converters only 490mm if inverters included		

AC Input	
AC connection	TN-S system, 3W + N + PE, (3-phases, neutral and protective earth wires)
Nominal input	220-240 VAC / 3 x 380-415 VAC TN-S system (options: 1- or 2-phase 100-250VAC, 3-phase 208-240VAC)
Input range	Max range: 85 – 300 VAC / 3 x 147–528 VAC Rated full power range: 180 – 275 VAC / 3 x 312–476 VAC (TN-S system) See derating curves below, 1200W per rectifier at 120VAC Temporary high voltage range 275 - 300VAC / 3 x 476 - 528VAC, continuous supply not recommended
Input frequency	Rated 45 - 66 Hz, reduced power at 35 - 45 Hz. Shut down at 35 Hz
Main Switch	63A, 4-pole (L1-L2-L3-N)
Rectifier input protection	MCB C16A / rectifier module
	24V 4.5kW 48V 6kW 60V 6kW 110V 6kW 125V 6kW 220V 6kW
Nominal current	8A @ 220/380V 11A @ 220/380VAC
Maximum phase current	12,5A @ 85-130V 12,5A @ 85-180VAC
Recommended mains fuse	3 x 25 A (TN-S)
	24V 9kW 48V 12kW 60V 12kW 110V 12kW 125V 12kW 220V 12kW
Nominal current	16A @ 220/380V 22A @ 220/380VAC
Maximum phase current	25A @ 85-130V 25A @ 85-180VAC
Recommended mains fuse	3 x 25 A (TN-S)

DC Output	24V	48V	60V	110V	125V	220V
Grounding	2-pole, floating					
Nominal voltage	24 VDC	48 VDC	60 VDC	108 VDC	120 VDC	216 VDC
Voltage factory setting, 2.27Vpc	27.24 VDC	54.48 VDC	68.10 VDC	122.58 VDC	136.20 VDC	245.16 VDC
Voltage range	21-33 VDC	42-59 VDC	51-72 VDC	90-150 VDC	100-160 VDC	178-280 VDC
Static voltage regulation	± 2 % @ load terminals (load, line, temp)			± 1 % @ load terminals (load, line, temp)		
Rectifier module output protection	MCB C63A	MCB C50A	MCB C40A	MCB C20A	MCB C20A	MCB C10A
	24V 4.5kW	48V 6kW	60V 6kW	110V 6kW	125V 6kW	220V 6kW
Quantity of rectifiers	Max 3 pcs					
Max current	187.5A @ 24V	125A @ 48V	100A @ 60V	55.5A @ 108V	50A @ 120V	27.8A @ 216V
Max Power	4.5kW	6kW	6kW	6kW	6kW	6kW
	24V 9kW	48V 12kW	60V 12kW	110V 12kW	125V 12kW	220V 12kW
Quantity of rectifiers	Max 6 pcs					
Max current	375A @ 24V	250A @ 48V	200A @ 60V	111A @ 108V	100A @ 120V	55.5A @ 216V
Max Power	9kW	12kW	12kW	12kW	12kW	12kW

Connection terminals	24V	48V	60V	110V	125V	220V
Mains terminal	X1 Mains input screw terminal blocks 10 mm ² , L1-L2-L3-N-PE					
DC Bulk Output XL1, included to BOM	Screw terminal 95mm ²	Screw terminal 95mm ²	Screw terminal 95mm ²	Screw terminal 50mm ²	Screw terminal 50mm ²	Screw terminal 50mm ²
DC load distribution	Configurable load distribution: 2-pole MCB +aux, connection to protection device directly					
Battery XB1-XB3, batt. qty configurable	Screw terminal 95mm ²	Screw terminal 95mm ²	Screw terminal 95mm ²	Screw terminal 50mm ²	Screw terminal 50mm ²	Screw terminal 50mm ²
Alarms & Inputs	Configurable relay alarms 12 pcs, Spring terminals 0.75mm ² ... 1.5mm ² cable Configurable alarm/temp. inputs 12 pcs, Spring terminals 0.75mm ² ... 1.5mm ² cable					

Battery and Load Connectios

Type A

Battery MCBs in air flow plate, max 125A, 2-pole, 1-3pcs

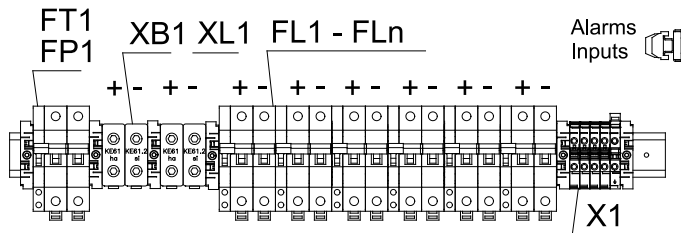
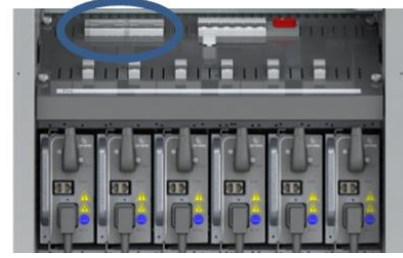

Type B

Battery Switch fuses, NH00 / NH01, max 250A, 2-pole, 1 pc

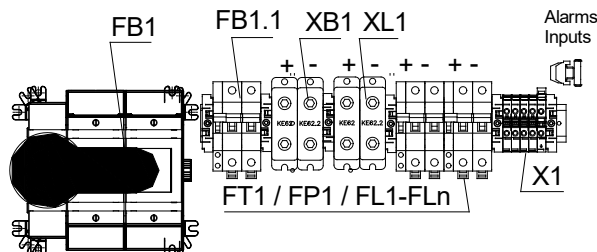
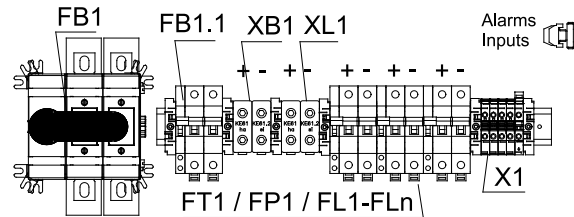

6kW (4.5kW) cabinets	24V 4.5kW	48V 6kW	60V 6kW	110V 6kW	125V 6kW	220V 6kW
MCB battery fuse Type A	MCB D125A 2-pole, 1-3pcs	MCB D125A 2-pole, 1-3pcs	MCB D125A 2-pole, 1-3pcs	MCB D63A 2-pole, 1-3pcs	MCB D63A 2-pole, 1-3pcs	MCB D63A 2-pole, 1-3pcs
Switch fuse battery fuse Type B	NH00 125A 2-pole, 1pc	NH00 125A 2-pole, 1pc	NH00 125A 2-pole, 1pc	NH00 63A 2-pole, 1pc	NH00 63A 2-pole, 1pc	NH00 63A 2-pole, 1pc

12kW (9kW) cabinets	24V 9kW	48V 12kW	60V 12kW	110V 12kW	125V 12kW	220V 12kW
MCB battery fuse Type A	MCB D250A 2-pole, 1pc	MCB D250A 2-pole, 1pc	MCB D250A 2-pole, 1pc	MCB D125A 2-pole, 1-3pcs	MCB D125A 2-pole, 1-3pcs	MCB D63A 2-pole, 1-3pcs
Switch fuse battery fuse Type B	NH01 250A 2-pole, 1pc	NH01 250A 2-pole, 1pc	NH01 250A 2-pole, 1pc	NH00 125A 2-pole, 1pc	NH00 125A 2-pole, 1pc	NH00 63A 2-pole, 1pc

Battery test option	MCB for external discharging test load
A+B parallel supply option	MCB + aux contact for System A + B parallel connection

DC output module	Configuration	Description
Bulk Output terminal, XL1	Included to cabinet BOM	Screw terminal 50-95mm ² 2-p, top of cabinet (wired)
Load MCB + aux, 2-pole, 2A – 63A	Select n x MCB code	Max 6cs of Load Distribution MCBs + aux contacts Max quantity depends on configurations and selected options Schneider C60H-DC series
Load MCB + aux, 1-pole, 2A – 63A	Option	Max 10cs of Load Distribution MCBs + aux contacts Max quantity depends on configurations and selected options 24V-60V models, Schneider iC60N series
Series diode (Blocking diode) module	Option	Semikron 160A, SKKD 162/16, heatsink P3/180

Block Diagram, Configurable Wall Cabinet options

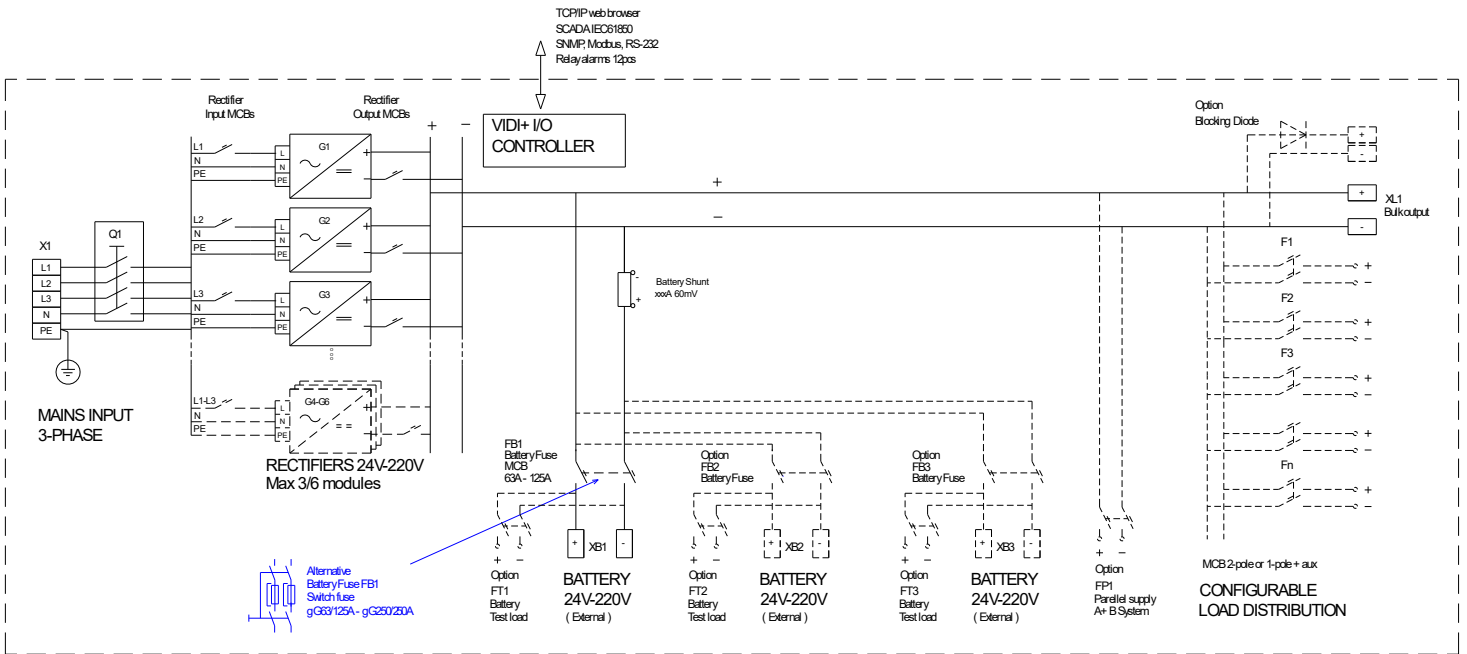

Mechanical Dimensions

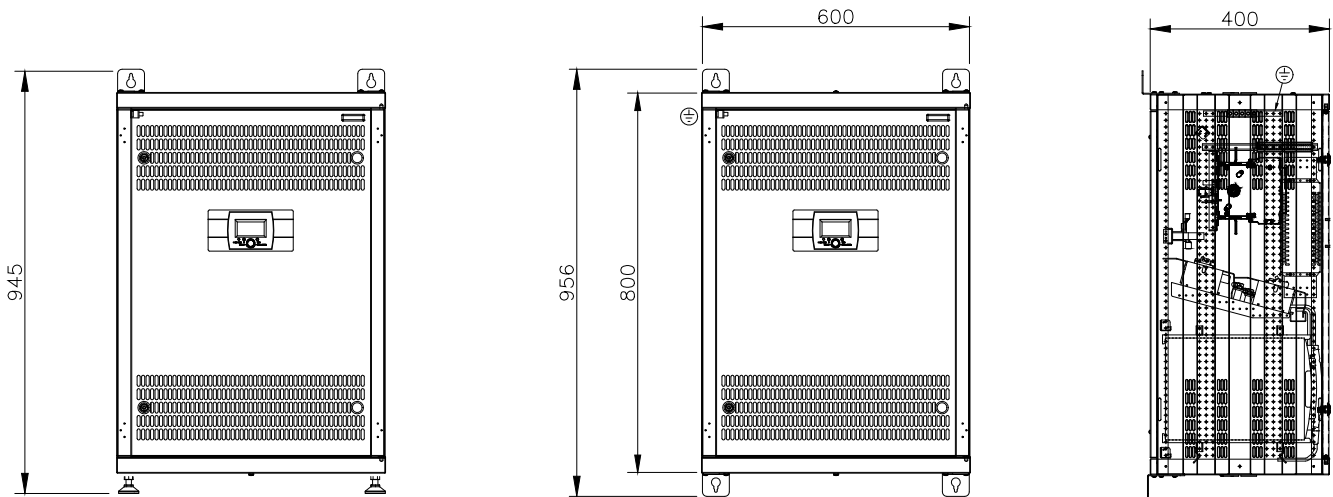

Derating curves

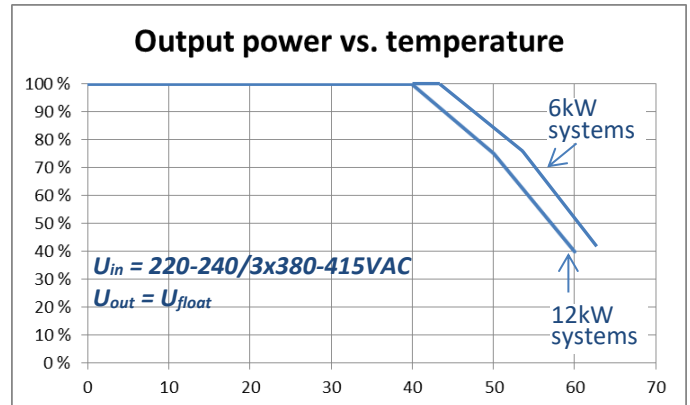
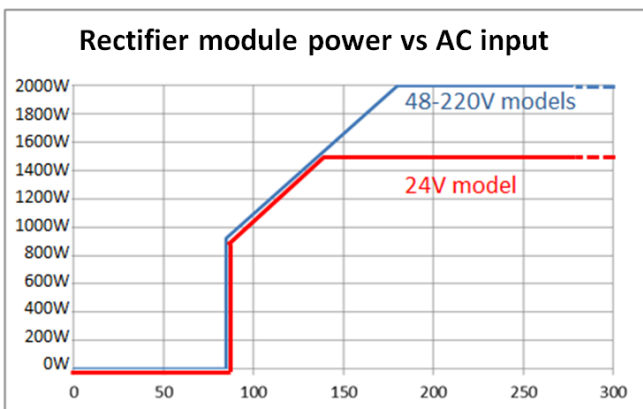

*) Derating curves are continuous power
Short time (<1h) 100% power up to +50°C

Optional configuration: Multi Voltage Systems including Inverters and DC/DC Converters

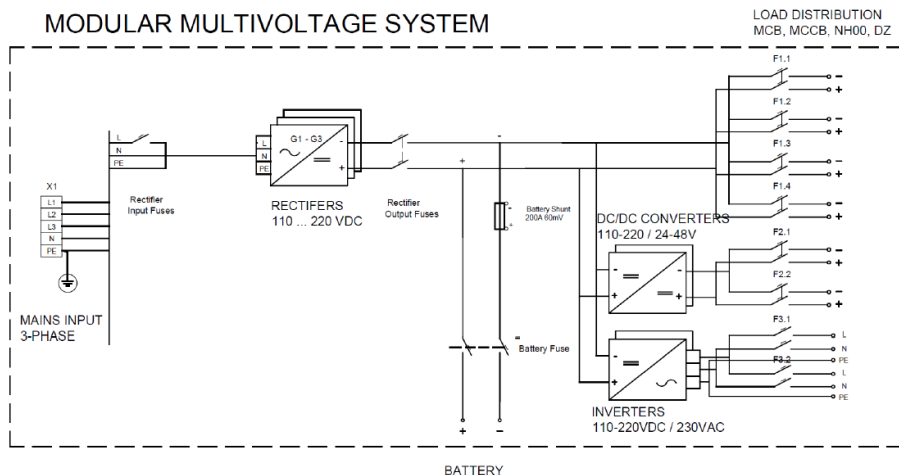
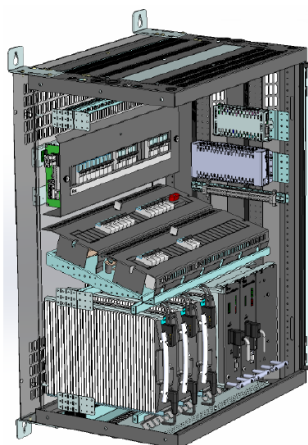

Application Note: Modernization of switching center panels, A + B double systems

OPUS OC864 Wall mountable modular charger, double system

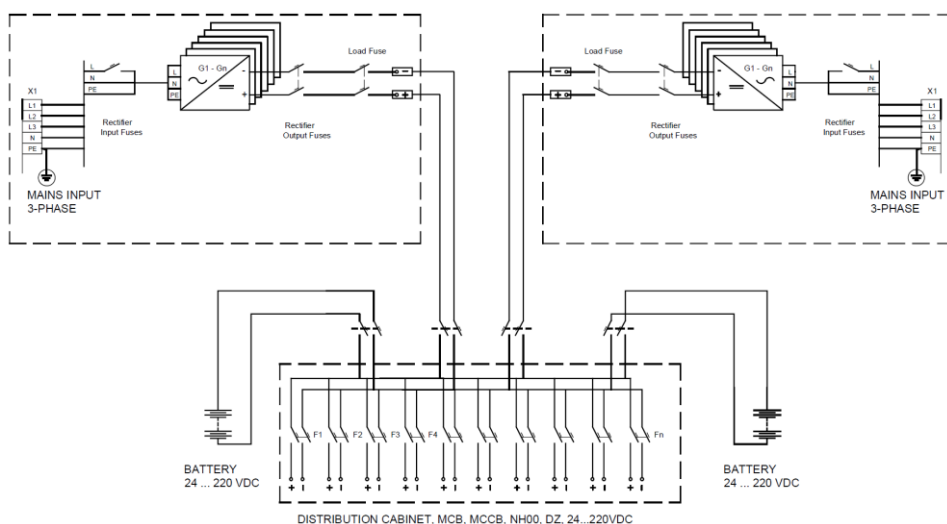
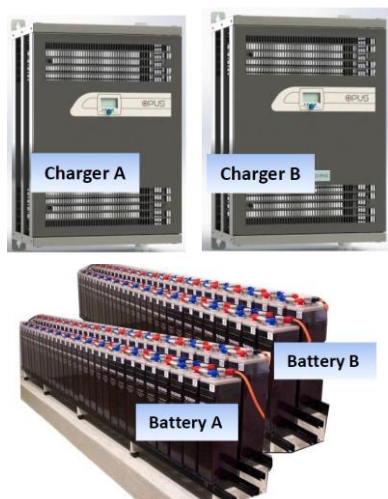

Order Information

Cabinet Systems MCB battery Fuses	Order Number	Cabinet Systems Switch Fuse battery Fuses	Order Number	Voltage / Current
OPUS HE 24-4.5 OC0864 F	922X015854	OPUS HE 24-4.5 OC0864 F	922X015866	24VDC / 62.5A – 187.5A
OPUS HE 24-9.0 OC0864 F	922X015855	OPUS HE 24-9.0 OC0864 F	922X015867	24VDC / 62.5A – 375A
OPUS HE 48-6.0 OC0864 F	922X015856	OPUS HE 48-6.0 OC0864 F	922X015868	48VDC / 41.7A – 125A
OPUS HE 48-12.0 OC0864 F	922X015857	OPUS HE 48-12.0 OC0864 F	922X015869	48VDC / 41.7A – 250A
OPUS HE 60-6.0 OC0864 F	922X015858	OPUS HE 60-6.0 OC0864 F	922X015870	60VDC / 33.3A – 100A
OPUS HE 60-12.0 OC0864 F	922X015859	OPUS HE 60-12.0 OC0864 F	922X015871	60VDC / 33.3A – 200A
OPUS HE 110-6.0 OC0864 F	922X015860	OPUS HE 110-6.0 OC0864 F	922X015872	110VDC / 18.5A – 55.5A
OPUS HE 110-12.0 OC0864 F	922X015861	OPUS HE 110-12.0 OC0864 F	922X015873	110VDC / 18.5A – 111A
OPUS HE 125-6.0 OC0864 F	922X015862	OPUS HE 125-6.0 OC0864 F	922X015874	125VDC / 16.7A – 50A
OPUS HE 125-12.0 OC0864 F	922X015863	OPUS HE 125-12.0 OC0864 F	922X015875	125VDC / 16.7A – 100A
OPUS HE 220-6.0 OC0864 F	922X015864	OPUS HE 220-6.0 OC0864 F	922X015876	220V / 18.5A – 27.8A
OPUS HE 220-12.0 OC0864 F	922X015865	OPUS HE 220-12.0 OC0864 F	922X015877	220VDC / 18.5A – 55.5A

Controllers, Description	Order number	Options, Description	Order number
Controllers, Description	94G910	VIDI-BM Block voltage monitoring	9040X0002338

Options, Description	Order number	System features
Temperature Sensor	94M268	Battery fuse blocks: See page 3 / price list / configuration files
IP21 Roof 600x435mm, height +90mm	832X015903	Load distribution: See page 3 / price list / configuration files
AC over voltage protection KIT 3L-N-PE	8320X0004402	Battery discharging test KIT, MCB 63A-125A, see config files
		Parallel supply KIT A+B system, MCB 63A-250A, see config