

- Few-cycle femtosecond pulses
- Stable performance with minimal intervention
- Measured pulses approaching transform limit
- Broadest spectral bandwidth commercially available
- Integrated pump laser

Overview

The **venteon** range of femtosecond oscillators uses ultra-short pulse laser technology and offers the shortest commercially available pulses at <5 fs (FTL), bandwidths >380 nm and average powers >900 mW. The compact monolithic design is optimised for low pump thresholds and contains an integrated pump laser. With long operational lifetimes, these instruments are highly reliable and extremely robust.

All **venteon** oscillators show an exceptional stability (Fig. 1) and beam shape (Fig. 2).

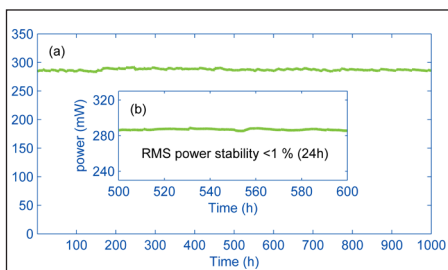

Fig. 1 Exceptional stability of the **venteon ultra** oscillator resulting from the optimised thermal and mechanical design.

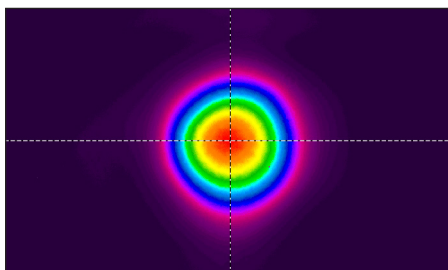

Fig. 2 Typical beam profile of the **venteon ultra** oscillator measured with a CCD camera.

The **venteon** cavity exclusively uses DCM mirrors that are created by ion beam sputtering techniques to ensure unsurpassed phase control and pulses that approach the theoretical values available. Laser Quantum supports clarity in reporting pulse duration and we always detail whether our figures are theoretical values based on Fourier transform calculations, or actual measured durations using **SPIDER** technology and instrumentation.

Minimal intervention



Sub-2-cycle pulse duration

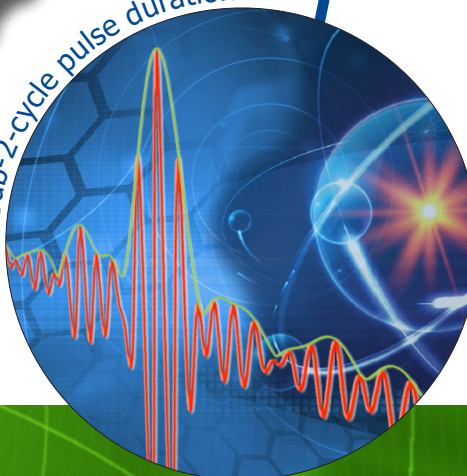

Broadband spectral output

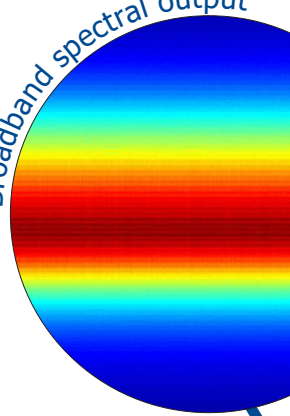

venteon one

The **venteon one** femtosecond oscillator is a versatile and robust option as an entry level to few cycle ultra-short pulses. Highly compact, with a footprint of 285 x 690 mm, it offers a wide spectral bandwidth of <200 nm leading to measured pulse durations of <8 fs. It is ideally suited to microscopy, spectroscopy and pump probe experiments that require a reliable and simple laser solution for ultra-short pulses with a moderate power.

venteon power

The **venteon power** femtosecond oscillator has been optimised to provide high output power at measured pulse durations less than 8 fs. The **venteon power** can be supplied with a CEP stabilised performance or state-ready for a CEP upgrade. It can also be equipped with a piezo transducer/linear actuator that allows for resonance free repetition rate locking to a suitable radio frequency reference source with locking bandwidths of up to 30 kHz.

venteon ultra

The **venteon ultra** femtosecond oscillator delivers >240 mW of <5.5 fs short pulses with an unrivalled spectral bandwidth ranging from 600 nm to 1200 nm specified with <5.5 fs @ -10 dBc. Due to this octave spanning output spectrum, the **venteon ultra** can be used for direct CEP stabilisation without any additional spectral broadening. The **venteon ultra** can be upgraded to a fully CEP stabilised laser, or with the necessary components to allow CEP upgrade at a later date.

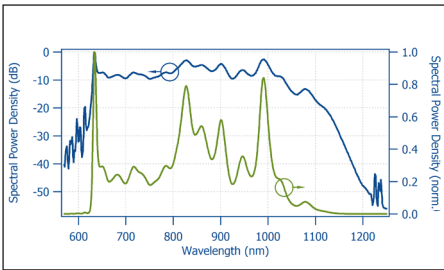

Typical **venteon ultra** spectrum spanning from >600 nm up to 1200 nm. This spectrum supports the shortest pulses commercially available and is ideally suited e.g. for a direct CEP stabilisation.

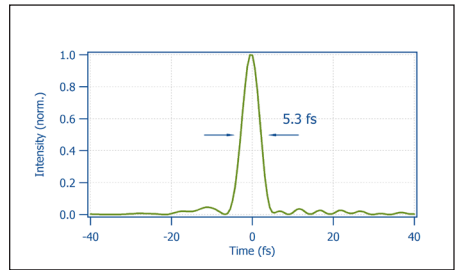

Typical **venteon ultra** pulse of <5.5 fs, measured with a **venteon SPIDER**.

venteon boost

The **venteon boost** femtosecond oscillator is optimized for maximum output pulse energy and power. Resulting pulse energies are larger than 11 nJ and average powers larger than 900 mW, representing the highest values delivered by a **venteon** oscillator. The **venteon boost** gives a measured pulse duration of <12 fs at a Fourier-transform-limited pulse duration of <10 fs.

venteon dual

The **venteon ultra** can be upgraded to the **venteon dual** via an additional module, representing the ideal front end for broadband few-cycle Optical Parametric Chirped Pulse Amplifier (OPCPA) applications. The **venteon dual** laser delivers two separate output ports for seeding an Yb-based amplifier pump stage and for the generation of broadband pulses as a signal for a subsequent NOPA stage.

venteon CEP5

The **venteon ultra** can also be upgraded to the **venteon CEP5** via an additional module, representing a fully configured ultra-short pulse carrier envelope phase (CEP) stabilised laser system with an integrated phase noise <100 mrad and sub-6 fs pulse duration.

Options and upgrades

Pulse train monitoring

An integrated high bandwidth (>10 GHz) photodiode can be used for repetition rate monitoring and to supply a signal to a **TL-1000** unit or external electronics.

Repetition rate control

Control of the repetition rate and active feedback is enabled by cavity mirrors mounted on piezoelectric actuators, enabling rapid feedback and long-term drift control simultaneously. In combination with the **TL-1000** repetition rate stabilisation unit, timing jitter <100 fs can be achieved. Alternatively, the piezos can be driven by customer supplied electronics.

Active locking of repetition rate and pulse timing

The **TL-1000** is an optional supporting unit that enables tight phase-locking of the repetition rate to an external reference with a residual timing jitter <100 fs.

CEPLoQ™ technology for the venteon CEP5

CEPLoQ™ technology directly modulates the pump power to maintain phase stabilisation without the use of an AOM. This leads to faster and more stable responses.



The **venteon** family is compatible with the Laser Quantum RemoteCom software that allows connection to the Laser Quantum support team for monitoring laser performance, diagnosing opportunities and carrying out laser optimisation.



Pump power modulation

Modulation access to the pump power with a bandwidth of >100 kHz and modulation depth up to ±1% is provided for feedback purposes.

Upgrades

	venteon one	venteon power	venteon ultra	venteon boost
Photodiode option	✓	✓	✓	✓
Repetition rate stabilisation option	✓	✓	✓	✓
CEP stabilisation		✓	✓	✓
CEP-zero stabilisation			✓	

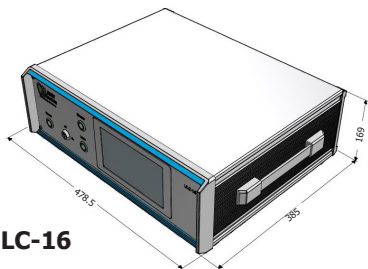
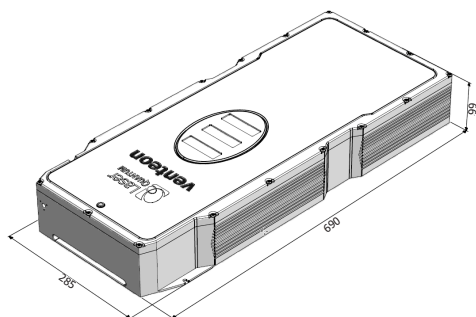

ULC-16

Other information

- Weight (head only): 33 kg
- Cooling system included
- 2 years/5000 hours (PSU 'on' time) full specification warranty



Drawings are for illustrative purposes only. Please contact Laser Quantum for complete engineer's drawings.

Specifications*

	venteon one	venteon power	venteon ultra	venteon boost
Average power output	>240 mW	>560 mW	>240 mW	>900 mW
Pulse energy (@80 MHz)	>3 nJ	>7 nJ	>3 nJ	>11 nJ
Central wavelength ¹	780 nm ± 30 nm	780 nm ± 30 nm	830 nm ± 30 nm	800 nm ± 30 nm
Spectral bandwidth (@-10 dBc)	>200 nm	>200 nm	>380 nm	>150 nm
Pulse duration (Measured) ²	<8 fs	<8 fs	<5.5 fs	<12 fs
Pulse duration (FTL)	<7.5 fs	<7.5 fs	<5 fs	<10 fs
RMS noise ³	<0.2 %	<0.1 %	<0.1 %	<0.1 %
Beam diameter ⁴	0.8 mm ± 0.3 mm	0.8 mm ± 0.3 mm	0.8 mm ± 0.3 mm	1.0 mm ± 0.3 mm
Divergence	<3 mrad	<3 mrad	<3 mrad	<3 mrad
M-squared	<1.2	<1.2	<1.2	<1.3
Power stability (RMS within 24 hrs)	<1 %			
Repetition rate ⁵	80 MHz			
Polarisation direction	horizontal			
Polarisation ratio	>100:1			
Operating temperature	21 °C +/- 3 °C			
Warm-up time	<20 min			
Weight (head only)	33 kg			

* Laser Quantum operates a continuous improvement programme which can result in specifications being improved without notice.

¹ Measured as the spectral centroid.

² Achieved using optional extra cavity dispersion compensation.

³ Noise bandwidth 1 Hz to 1 MHz.

⁴ FWHM beam diameter at laser exit.

⁵ Repetition rate accuracy +/-100 kHz. Other repetition rates available upon request.

LASER QUANTUM LTD

tel: +44 (0) 161 975 5300

email: info@laserquantum.com

web: www.laserquantum.com

LASER QUANTUM INC

tel: +1 510 210 3034

email: info@laserquantum.com

web: www.laserquantum.com

LASER QUANTUM GmbH

tel: +49 7531 368371

email: info@laserquantum.com

web: www.laserquantum.com