

Cascade

DCP-HTR

High-Performance DC Parametric Probe

000111100010

Overview

The DCP-HTR probe delivers fA-level measurement capability from -65°C to 300°C for advanced characterization and reliability testing. Its unique design offers superior guarding and shielding over-temperature, overcoming the high-temperature performance limitations of standard coaxial needles. For full-triaxial current/voltage over-temperature measurements, using triaxial cables, the DCP-HTR probe should be used with FormFactor's parametric probing systems with MicroChamber® and AttoGuard® technology. When used with MicroChamber, the DCP-HTR allows full utilization of semiconductor parametric test instruments. The optional probe tips with small diameter are ideal for probing pads as small as 30 µm x 30 µm.



Features / Benefits

Low-noise electrical performance	<ul style="list-style-type: none">• Ultra-low, fA-level current and fF-level capacitance measurements from -65°C to + 300°C
Microstrip probe tips	<ul style="list-style-type: none">• Guarantees fully-guarded measurements to fA and fF levels
Precision, industry-standard SSMC 50 Ω connectors	<ul style="list-style-type: none">• Individual connectors provide force-sense connection for quasi-Kelvin and CV measurements
Selection of probe tip diameters	<ul style="list-style-type: none">• Allows probing of different pad materials and sizes
Easily replaceable probe tips	<ul style="list-style-type: none">• Fast replacement of worn probes without the need for tools

General Specifications

Breakdown voltage	>500 V
Isolation resistance	>1 x 10E ¹³ Ω
Frequency response (3 dB)	150 MHz
Mounted temperature range	-65°C to +300°C (above 250°C: 8 hours max operation)
Typical leakage and noise current	±10 fA at -65°C to 200°C, ±20 fA at 200°C to 300°C
Residual capacitance	<100 fF (probe tip in air at room temperature)
Characteristic impedance	50 Ω
Body material	Gold plated
Connector type	SSMC
Minimum pad size	30 μm x 30 μm (10 μm radius tips required)

Tip Specifications

Tip material	Tungsten
Contact force	3 gram/25 μm
Scrub	Typically 2.5:1 skate ratio (25 μm overdrive = 10 μm skate)
MicroChamber compatible	Yes
AttoGuard compatible	Yes

PN (10-PK)	TIP SHAPE	TIP Ø (μm)	TIP Ø TOL (μm)	Depth (in.)	BEAM ANGLE
154-001	Radius	19	± 3.8	0.358	7°
154-003		10	± 2.5		
154-329	Flat	38	± 5		

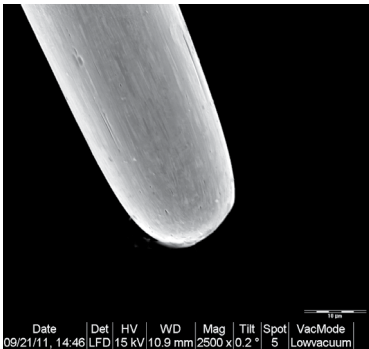

Radius Tip

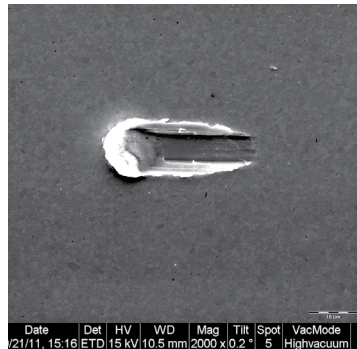

154-001 19 μm

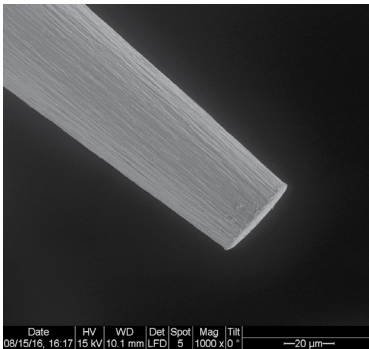

Flat Tip

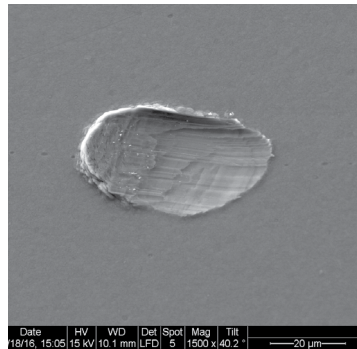

154-329 38 μm

Dimensions

DCP-HTR Probe Body

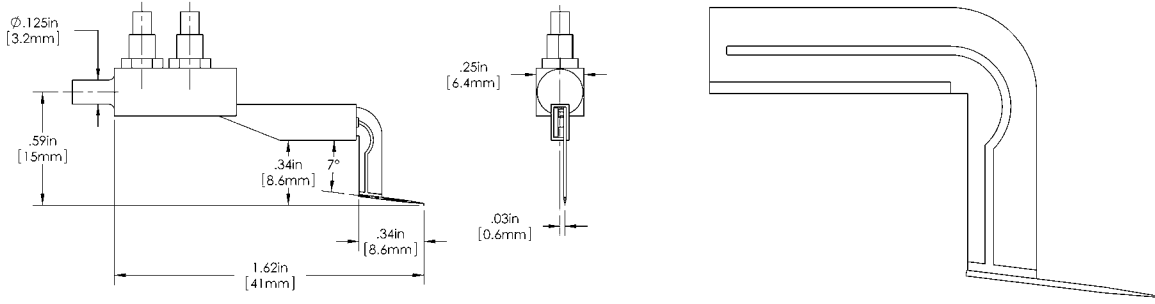

Tip Shape

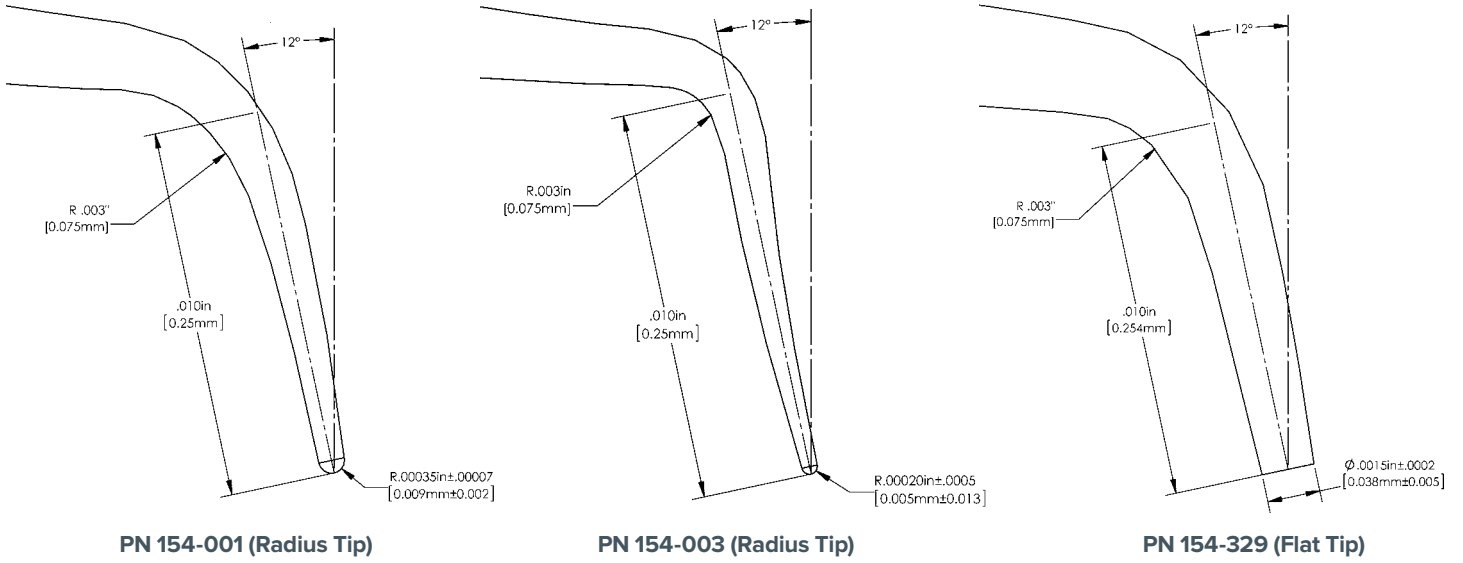

Dimensions

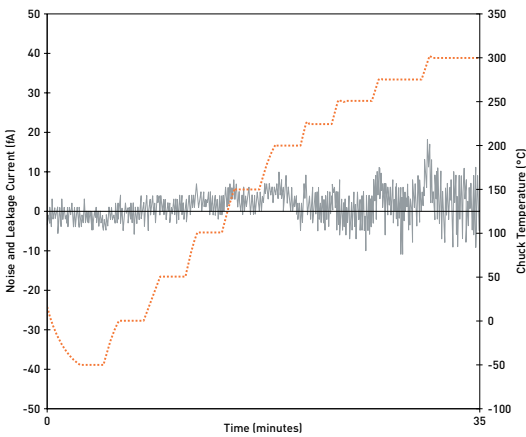

Typical DCP-HTR probe noise and leakage over temperature when used in conjunction with FormFactor probe station with MicroChamber and AttoGuard technology

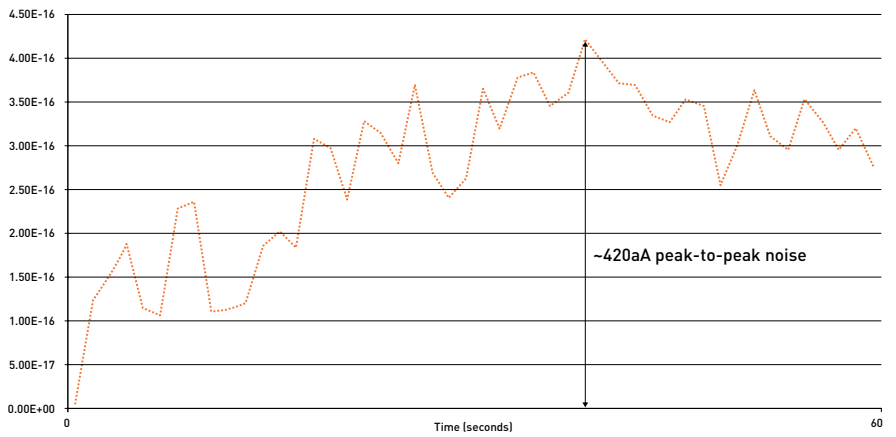

Typical DCP-HTR probe noise and leakage at ambient when used in conjunction with FormFactor probe station with MicroChamber and AttoGuard technology

➤ Regulatory Compliance

CE certified, CB compliance tested, certified for US and Canada (cNRTLus).

➤ Available Options

Warranty*	Fifteen months from date of delivery or twelve months from date of installation
Service contracts	Single- and multi-year programs available to suit your needs

* See FormFactor's Terms and Conditions of Sale for more details.

➤ Ordering Information

PART NUMBER	DESCRIPTION
DCP-HTR	DCP-HTR DC probe holder
151-286	Thermally-stable probe arms for DCP-HTR (for MS-1 positioners, triax)
151-287	Thermally-stable probe arms for DCP-HTR (for DCM positioners, triax)
151-288	Thermally-stable probe arms for DCP-HTR (for DCM positioners, coax)
154-001	Replaceable probe tips, box of 10, radius tip, 19 µm diameter
154-003	Replaceable probe tips, box of 10, radius tip, 10 µm diameter
154-329	Replaceable probe tips, box of 10, flat tip, 38 µm diameter
138-020	Edge Sense, single blade ceramic needle for DCP-HTR probe body

© Copyright 2018 FormFactor, Inc. All rights reserved.
FormFactor and the FormFactor logo are trademarks
of FormFactor, Inc. All other trademarks are the property
of their respective owners.

All information is subject to change without notice.

DCP-HTR-DS-0518