



RIFTEK
Sensors & Instruments



LASER SEAM TRACKING SYSTEM FOR WELDING AUTOMATION

RF627Weld Series

User's manual

Contents

1.	Safety precautions	5
2.	CE compliance	5
3.	Laser safety	5
4.	General information	5
5.	Structure	5
5.1.	Laser scanner	6
5.2.	Riftek Lamia software	6
5.3.	Controller	6
5.4.	Cables	7
5.4.1.	UNITRONIC® LiYCY (TP) cable	7
5.4.2.	RJ-45 Ethernet cable	8
5.4.3.	Power cable	8
5.5.	Calibration plate	8
6.	Operating principle	8
7.	Basic technical data	9
7.1.	Laser scanner	9
7.1.1.	Specification	9
7.1.2.	Working ranges and overall dimensions	9
7.2.	Controller	11
7.2.1.	Specification	11
7.2.2.	Overall dimensions	12
8.	Example of item designation when ordering	12
9.	Overall demands for mounting	12
10.	Ethernet interface	13
11.	Network configuration	13
12.	Connection procedure	14
13.	Setting parameters of the scanner	14
14.	Web page	14
15.	Riftek Lamia software	16
15.1.	System requirements	16
15.2.	Installation	16
15.3.	User's interface	17
15.3.1.	Main window	17
15.3.2.	"Settings" window	18
15.3.3.	"About" window	19
15.3.4.	Keyboard shortcuts	19
15.4.	"SEARCH" tab. Search, connection and settings	20
15.4.1.	Search for scanners	20
15.4.2.	Connection	21
15.4.3.	Setting parameters	23
15.4.3.1.	Procedure	23
15.4.3.2.	Parameters	23
15.4.3.2.1.	"Sensor" panel	23
15.4.3.2.2.	"Region of interest" panel	24
15.4.3.2.3.	"Network" panel	25
15.4.3.2.4.	"Stream" panel	26
15.4.3.2.5.	"Image processing" panel	26
15.4.3.2.6.	"Laser" panel	27
15.4.3.2.7.	"General" panel	27
15.4.3.2.8.	"RF625 compatibility" panel	27
15.5.	"MATHS" tab. Selecting a template for seam tracking	28
15.5.1.	General information	28
15.5.2.	Search parameters ("SEARCH" tab)	29
15.5.3.	Template parameters ("TEMPLATE" tab)	31
15.5.4.	List of measurements ("SELECT" tab)	32

15.5.5.	Built-in templates.....	34
15.5.5.1.	"Measurement" set.....	34
15.5.5.1.1.	Template 1 "Corner".....	34
15.5.5.1.2.	Template 2 "Step".....	35
15.5.5.1.3.	Template 3 "Triangle".....	36
15.5.5.1.4.	Template 4 "Gap".....	37
15.5.5.1.5.	Template 5 "Right edge".....	38
15.5.5.1.6.	Template 6 "Left line".....	39
15.5.5.1.7.	Template 7 "Right line".....	40
15.5.5.1.8.	Template 8 "Point".....	41
15.5.5.1.9.	Template 9 "Point, Y min".....	42
15.5.5.1.10.	Template 10 "Groove".....	43
15.5.5.1.11.	Template 11 "Angle".....	44
15.5.5.1.12.	Template 12 "Slope".....	45
15.5.5.1.13.	Template 13 "Gap width".....	46
15.5.5.1.14.	Template 14 "Amplitude".....	47
15.5.5.1.15.	Template 15 "Lowest / Highest point".....	48
15.5.5.1.16.	Template 16 "Hill".....	49
15.5.5.1.17.	Templates 17 and 18 "Radius and circle center".....	50
15.5.5.2.	"Welding" set.....	51
15.5.5.2.1.	Template 1 "Fillet weld".....	51
15.5.5.2.2.	Template 2 "Corner weld".....	52
15.5.5.2.3.	Template 3 "Lap weld".....	53
15.5.5.2.4.	Template 4 "Square-groove butt weld".....	54
15.5.5.2.5.	Template 5 "V-groove weld".....	55
15.5.5.2.6.	Template 6 "Left edge".....	56
15.5.5.2.7.	Template 7 "Right edge".....	57
15.5.5.2.8.	Template 8 "Spot weld".....	58
15.5.5.2.9.	Template 9 "Nearest point".....	59
15.5.5.2.10.	Template 10 "Slope".....	60
15.5.6.	Operations with templates.....	61
15.5.6.1.	Adding a template.....	61
15.5.6.2.	Copying a template.....	61
15.5.6.3.	Removing a template.....	61
15.5.6.4.	Changing the order.....	62
15.5.6.5.	Restoring a default set of templates.....	62
15.5.7.	Template Wizard.....	62
15.6.	"PROTOCOLS" tab. Working with welding robots.....	64
15.6.1.	General information.....	64
15.6.2.	Functional diagram.....	64
15.6.3.	Connection procedure.....	65
15.6.4.	Riftek P1 protocol.....	65
15.6.4.1.	General information.....	65
15.6.4.2.	Packets and parameters.....	66
15.6.4.3.	Types of calculations (commands) and assignment of registers.....	66
15.6.5.	R691 USI protocol.....	67
15.6.5.1.	General information.....	67
15.6.5.2.	Client (robot) requests.....	68
15.6.5.3.	Scanner answers.....	70
15.6.5.4.	Error codes.....	70
15.6.5.5.	Scanner status.....	71
15.6.5.6.	Example.....	71
15.6.6.	Riftek P2 protocol.....	71
15.6.6.1.	General information.....	71
15.6.6.2.	Holding registers.....	73
15.6.6.3.	Operation logic.....	73
15.6.7.	Riftek P3 protocol.....	74

- 15.6.7.1. General information..... 74
- 15.6.7.2. Explicit messaging..... 75
 - 15.6.7.2.1. Identity object (class 0x01)..... 75
 - 15.6.7.2.2. TCP/IP object (class 0xF5)..... 75
 - 15.6.7.2.3. Ethernet link object (class 0xF6)..... 76
- 15.6.7.3. Implicit messaging..... 76
 - 15.6.7.3.1. Assembly object (class 0x04)..... 76
 - 15.6.7.3.2. Input assembly (instance 0x65)..... 76
 - 15.6.7.3.3. Output assembly (instance 0x66)..... 77
 - 15.6.7.3.4. Configuration assembly (instance 0x64)..... 77
- 15.6.8. PureUDP protocol..... 78
 - 15.6.8.1. General information..... 78
 - 15.6.8.2. Holding registers..... 79
 - 15.6.8.3. Operation logic..... 80
- 15.6.9. Scanner calibration..... 80
 - 15.6.9.1. "Calibration" panel..... 80
 - 15.6.9.2. Calibration procedure..... 81
- 16. Firmware update..... 83
- 17. Maintenance..... 83
- 18. Troubleshooting..... 84
- 19. Warranty policy..... 84
- 20. Technical support..... 84
- 21. Revisions..... 85
- 22. Distributors..... 85

1. Safety precautions

- Use supply voltage and interfaces indicated in the scanner and controller specifications.
- When connecting / disconnecting cables, the power of the scanner and controller must be turned off.
- To obtain stable results, wait about 20 minutes after scanner activation to achieve uniform scanner warm-up.
- The scanner and controller must be grounded.

2. CE compliance

The system has been developed for use in industry and meets the requirements of the following Directives:

- EU directive 2014/30/EU. Electromagnetic compatibility (EMC).
- EU directive 2011/65/EU, “RoHS” category 9.

3. Laser safety

Scanners belong to 2M laser safety class according to IEC/EN 60825-1:2014.

Scanners make use of an c.w. 660 nm or 405 nm or 450 nm or 808 nm wavelength semiconductor laser. Maximum output power is 10 mW. The following warning label is placed on the scanner housing:

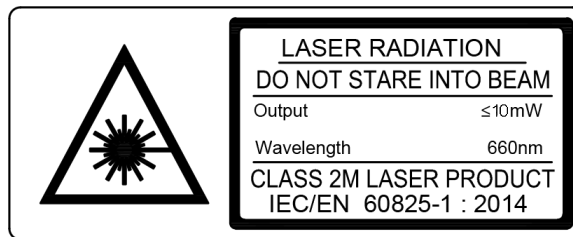

The following safety measures should be taken while operating the scanners:

- Do not target laser beam to humans.
- Do not disassemble the scanner.
- Avoid staring into the laser beam.

4. General information

The Seam Tracking System is designed to be used in robotic welding systems and is intended to automatically control the position of the welding head during the welding process.

5. Structure

The system includes the following components:

- Laser scanner RF627Weld.
- Riftek Lamia software.
- Controller (optional).
- Cables.
- Calibration plate.

5.1. Laser scanner

The system includes a laser scanner (RF627Weld Series) equipped with an air-cooling system, replaceable glasses and a special attachment mechanism designed to fix the scanner to the welding robot.

The housing of the scanner is made of anodized aluminum. The front panel of the housing has two windows: the output window and the window for receiving radiation reflected from the object under control.

The scanner has one connector, **Reset** button and LED indicators. Pressing the **Reset** button for 5 seconds will restart the scanner. If you press the **Reset** button for 1 second, a broadcast Hello packet will be sent. Red LED indicates that the firmware is loading; green LED indicates that the Ethernet connection is established.

The following configurations are available:

- red laser scanners, 660 nm;
- blue laser scanners (BLUE version), 405 or 450 nm;
- infrared laser scanners (IR version), 808 nm.

We use different lasers due to a wide range of applications. For example, the use of blue lasers instead of red ones is optimal for the control of shiny materials and high-temperature objects.

There are two operating modes in the full working range: Basic mode with the frequency of 484 Hz (profiles/second) and DS mode with the frequency of 938 Hz.

In addition, you can use the ROI function, which makes it possible to increase the working frequency of the scanner in the limited working range up to 5096 Hz in Basic mode and up to 6800 Hz in DS mode.

Specifications, working ranges and overall dimensions are given in section [7.1](#).

5.2. Riftek Lamia software

Riftek Lamia is a multifunctional software application designed to be used in automated industrial systems.

Riftek Lamia is intended for:

- recognizing, tracking and measuring geometric parameters of objects (for example, welding joints and welds) in real-time mode;
- connecting to the client controller to transmit results;
- data visualization.

A detailed description of Riftek Lamia software is given in section [15](#).

5.3. Controller

The controller is an industrial tablet PC that has Riftek Lamia software installed.



Figure 1

Designations:

1. RJ-45 Ethernet connector.
2. Wi-Fi / Bluetooth antenna.
3. USB 2.0 connectors.
4. Scanner connector.
5. Power button.
6. Power connector.

Since the controller has the Wi-Fi antenna, the user can connect to the controller via a remote desktop or via the SSH protocol by creating an access point.



The controller comes optional. Instead of the controller, the customer can use a PC with Riftek Lamia software installed and a power supply unit.

Technical characteristics and overall dimensions are given in section [7.2](#).

5.4. Cables

The system comes with three cables:

1. UNITRONIC® LiYCY (TP) cable.
2. RJ-45 Ethernet cable.
3. Power cable.

5.4.1. UNITRONIC® LiYCY (TP) cable

The UNITRONIC® LiYCY (TP) cable is used to connect the scanner to the controller.

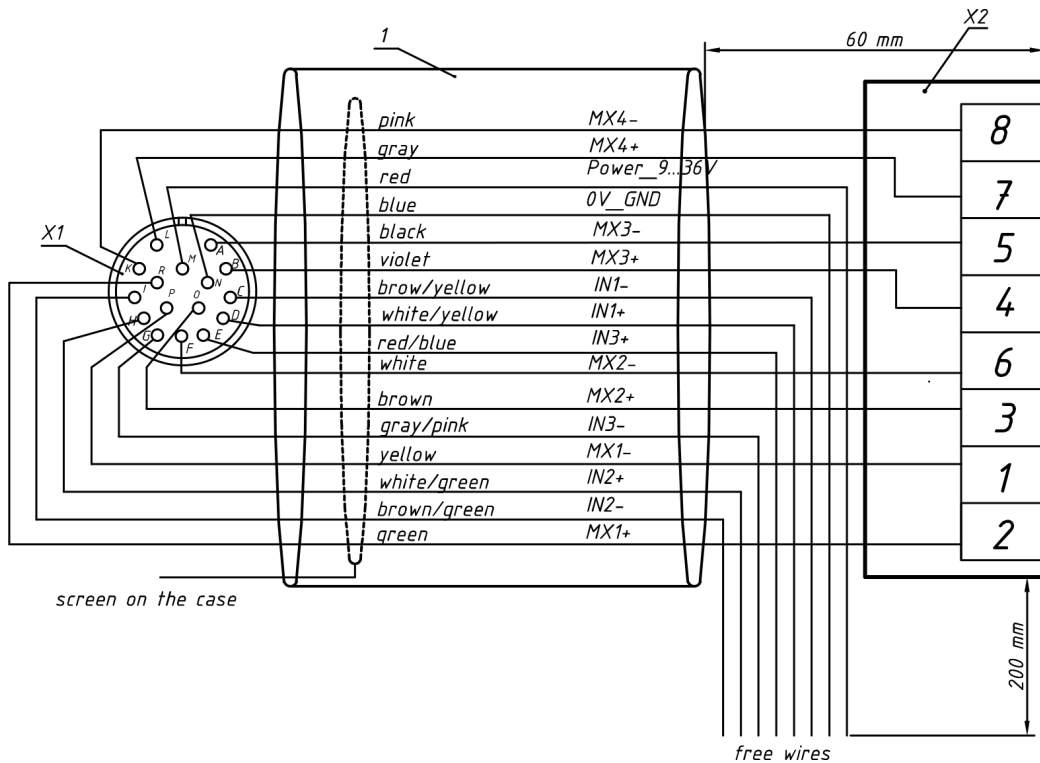

Designations:

Name	Description
X1	Binder 423 99 5456 15 16
X2	RJ-45
1	LAPP KABEL UNITRONIC® LiYCY (TP) cable, #0035150, 8x2x0.14

Assignment of cable wires is given in the table below:

Pin number	Wire color	Assignment
K	Pink	MX4-
L	Gray	MX4+
M	Red	Power 9...36V
N	Blue	0V GND
A	Black	MX3-
B	Violet	MX3+
C	Brown / Yellow	IN1-
D	White / Yellow	IN1+
E	Red / Blue	IN3+
F	White	MX2-
O	Brown	MX2+
G	Gray / Pink	IN3-
P	Yellow	MX1-
H	White / Green	IN2+
I	Brown / Green	IN2-
R	Green	MX1+



If the order does not include a controller, the UNITRONIC® LiYCY (TP) cable will be compressed to RJ-45 Ethernet and two power wires (red and brown).

5.4.2. RJ-45 Ethernet cable

The RJ-45 Ethernet cable is used to connect the scanner controller to the robot controller.

5.4.3. Power cable

The power cable is used to connect the scanner controller to 220V AC.

5.5. Calibration plate

The calibration plate is used to calibrate the scanner relative to the welding robot. The calibration procedure is described in par. [15.6.8.](#)

6. Operating principle

The laser scanner is mounted on the flange of the robot next to the welding torch. The scanning area is located directly in front of the welding electrode at a distance of several centimeters. The scanner controller processes the information received from the scanner in accordance with the selected mathematical algorithm that determines the exact coordinates of the welding joint. In real time, the scanner controller transmits the coordinates to the robot controller, and the robot controller corrects the position of the welding torch during the welding process.

7. Basic technical data

7.1. Laser scanner

7.1.1. Specification

Sampling rate, accuracy, resolution	
Nominal sampling rate (full working range)	484 profiles/s (standard mode), 938 profiles/s (DS mode)
Maximum sampling rate (ROI mode)	5096 profiles/s, 6800 profiles/s (DS mode)
Linearity (measurement error), Z axis	±0.05% of the range (standard mode), ±0.1% of the range (DS mode)
Linearity (measurement error), X axis	±0.2% of the range
Resolution, Z axis	0.01% of the range (standard mode), 0.02% of the range (DS mode)
Resolution, X axis	648 or 1296 points (programmable value)
Laser	
660 nm or 405 nm or 450 nm or 808 nm Class 2M according to IEC/EN 60825-1:2014	
Interface	
Basic	Ethernet / 1000 Mbps
Synchronization inputs	RS422, 3 channels
Power supply	9...30 V or 12...39 V for scanners with Blue laser
Power consumption, not more	6 W (without a built-in heater)
Environmental resistance	
Enclosure rating	IP67
Vibration	20 g / 10...1000 Hz, 6 hours for each of XYZ axes
Shock	30 g / 6 ms
Operating ambient temperature	-20...+40°C or -20...+120°C for scanners with built-in air cooling system
Storage temperature	-20...+70°C
Relative humidity	5-95% (no condensation)
Housing/windows material	aluminum/glass

7.1.2. Working ranges and overall dimensions

Range	MR, mm	SMR, mm	Xsmr, mm	Xemr, mm	Size, mm	Weight, g
68/25-22/24	25	68	22	24	Figure 2	0.7
69/130-35/130	130	69	35	130	Figure 3	0.7
91/250-65/180	250	91	65	180	Figure 4	0.7

Detailed CAD documentation (2D and 3D) is available on request at support@riftek.com.

Overall and mounting dimensions of laser scanners:

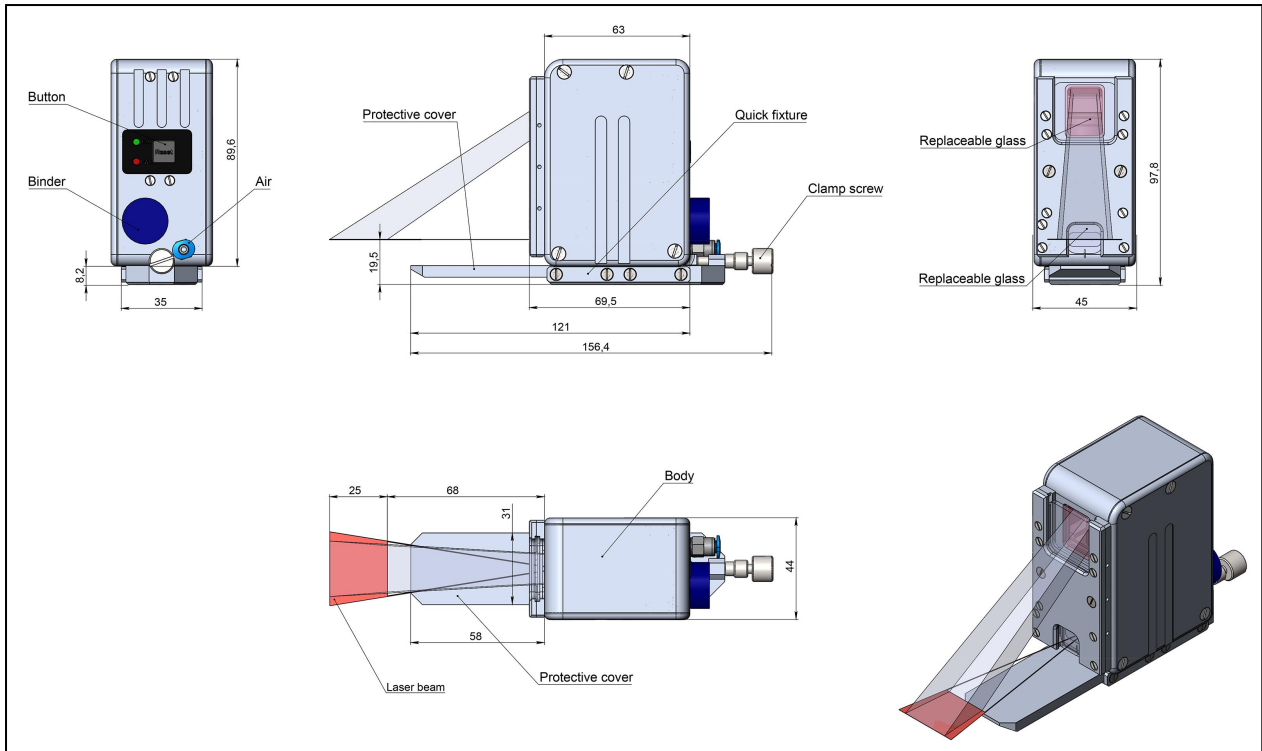

Figure 2

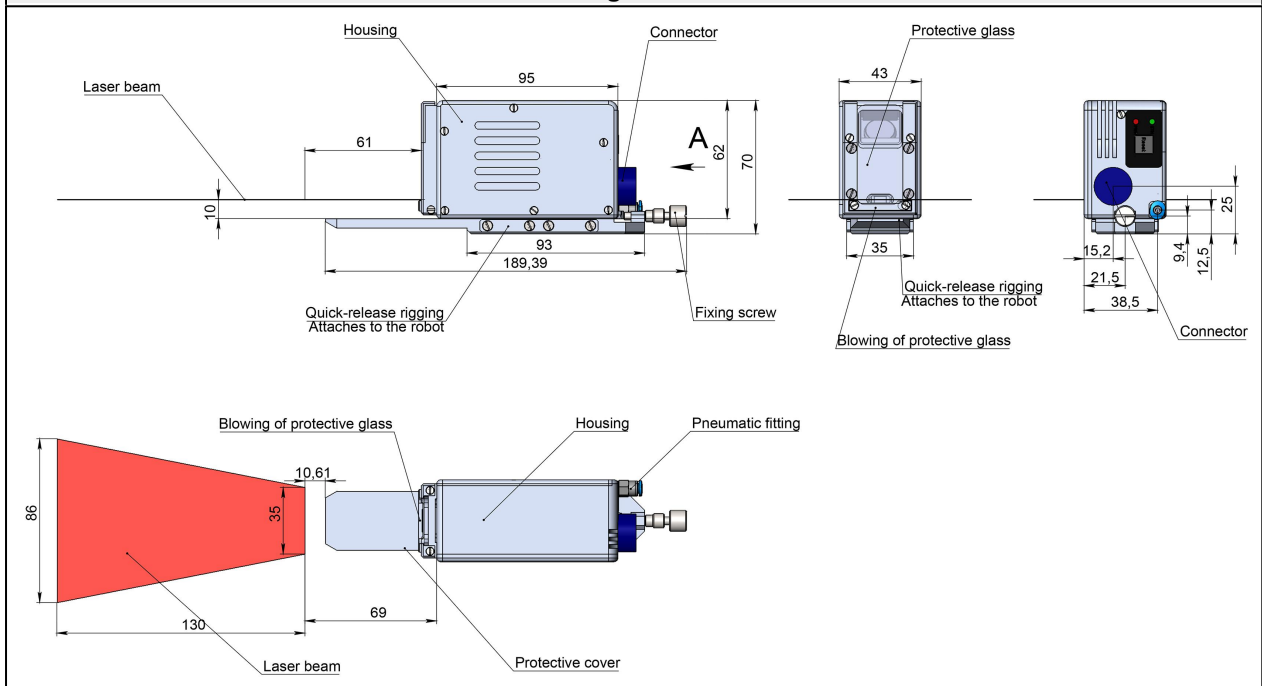

Figure 3

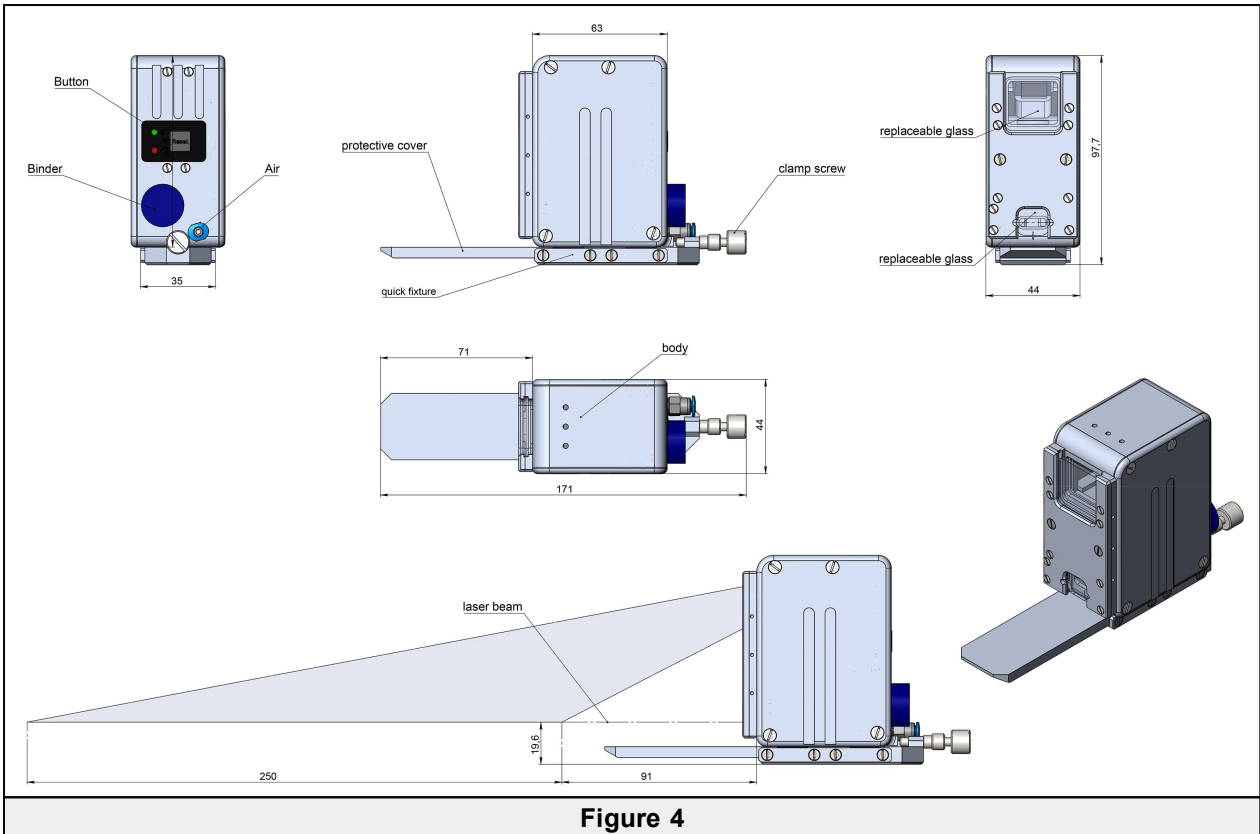

Figure 4

7.2. Controller

7.2.1. Specification

Parameter		Value
Screen size		10"
Screen resolution		1366x768
Screen type		IPS
Operating system		GNU/Linux
RAM		2 GB
Internal memory		32 GB
Power supply		220 V
Environmental resistance	Relative humidity	5-95% (no condensation)
	Operating ambient temperature	0...+45 °C
	Storage temperature	-20...+65 °C
Housing material		aluminum
Weight, gram		2500

7.2.2. Overall dimensions

Overall and mounting dimensions of the controller are shown in Figure 5:

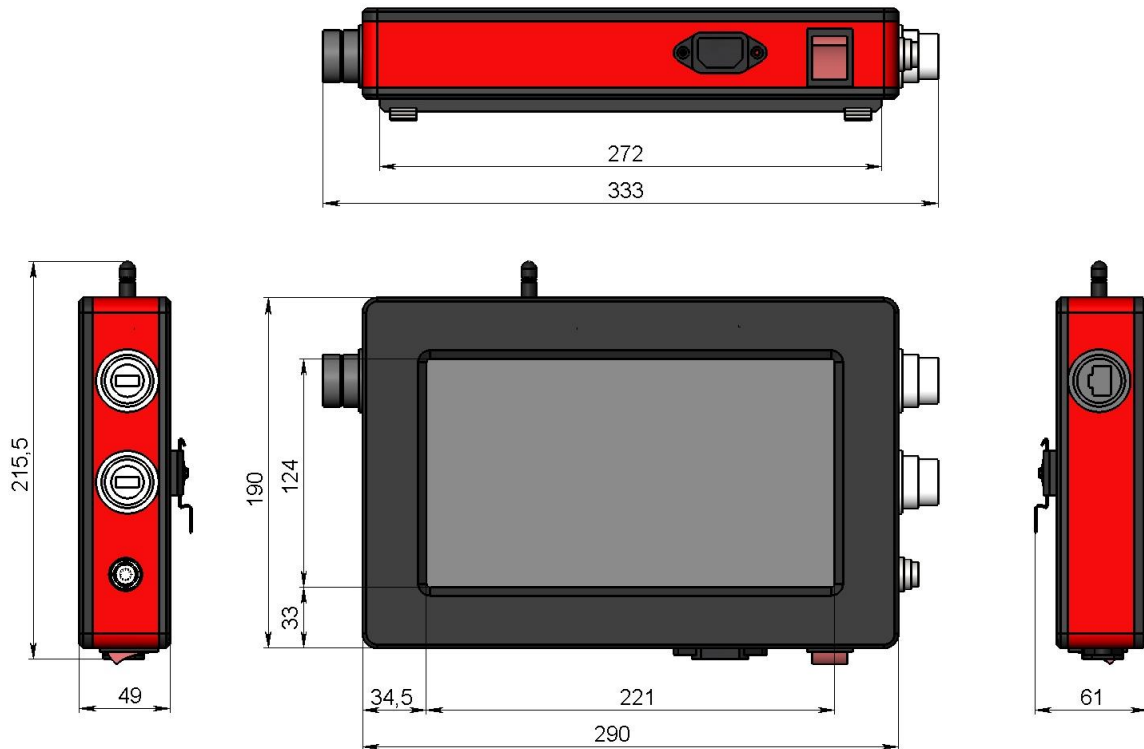

Figure 5

8. Example of item designation when ordering

RF627Weld.(WAVE)-SMR/MR-Xsmr/Xemr-M(R)-AC-C

Symbol	Description
(WAVE)	Laser wavelength. 660 nm – no symbol, 405 nm or 450 nm – BLUE, 808 nm – IR.
SMR	Beginning of the measuring range for Z, mm.
MR	Measuring range for Z, mm.
Xsmr	Measuring range for X-coordinate at the beginning of the measuring range for Z-coordinate, mm.
Xemr	Measuring range for X-coordinate at the end of the measuring range for Z-coordinate, mm.
M	Cable length, m.
R	Option, robot-cable.
AC	Built-in air cooling system. Ordering a water cooling system requires consultation with the manufacturer.
C	Controller.

Example. RF627Weld.BLUE-70/50-30/42-5-AC-C – Scanner with a blue laser, SMR - 70 mm, MR - 50 mm, Xsmr - 30 mm, Xemr - 42 mm, cable length - 5 m, air cooling system, controller.

9. Overall demands for mounting

The laser scanner is mounted on the robot flange next to the welding torch. The scanning area must be within the working range of the scanner. In addition, no foreign objects should be allowed to stay on the path of the incident and reflected laser radiation.

When scanning a surface with an intricate texture, the incidence of mirror component of the reflected radiation to the receiving window should be minimized.

**ATTENTION!**

The scanner and controller must be grounded. Static electricity may cause the failure of electronic components. To ground the controller, use the DIN rail.

10. Ethernet interface

Profiles are transferred between the scanner and the controller over the UDP protocol, the structure of packets is described in the Developer Guide. Download link:

https://riftek.com/upload/iblock/205/RF627_Software_Tools_eng.pdf

11. Network configuration

All scanners are shipped with the following network configuration unless otherwise specified in the order:

- Autonegotiation of connection speed (100/1000 Mbps)
- IP address of the scanner: 192.168.1.30
- Subnet mask: 255.255.255.0
- Gateway: 192.168.1.1
- Host IP address (device that receives profiles): 192.168.1.2
- Host port that receives data: 50001
- HTTP connection port (for connecting a browser): 80
- Service port of the scanner: 50011
- Ethernet/IP service port: 44818

If the order does not include a controller, it is necessary to configure the network card of the PC in the 192.168.1.* address space. An example:

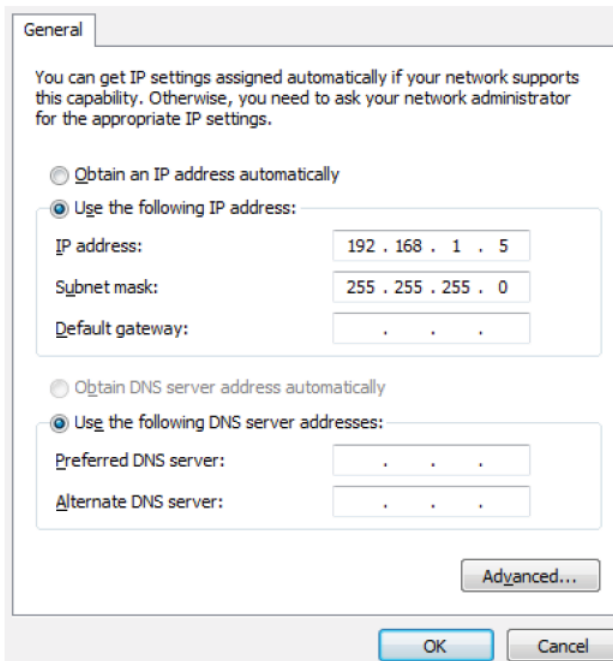

General

You can get IP settings assigned automatically if your network supports this capability. Otherwise, you need to ask your network administrator for the appropriate IP settings.

Obtain an IP address automatically

Use the following IP address:

IP address: 192 . 168 . 1 . 5

Subnet mask: 255 . 255 . 255 . 0

Default gateway:

Obtain DNS server address automatically

Use the following DNS server addresses:

Preferred DNS server:

Alternate DNS server:

Advanced...

OK Cancel

NOTE: Ethernet Jumbo frames are not supported by the scanner.

12. Connection procedure

System with controller		System without controller *	
#	Description	#	Description
1	Connect the scanner to the controller using a UNITRONIC® LiYCY (TP) cable.	1	Connect the scanner to the PC using a UNITRONIC® LiYCY (TP) cable compressed to RJ-45 Ethernet and two power wires.
2	Connect the scanner controller to the robot controller using an RJ-45 Ethernet cable.	2	Connect the PC to the robot controller using an RJ-45 Ethernet cable.
3	Connect the scanner controller to 220V AC using a power cable.	3	Connect the scanner to the power supply unit (red wire is a "plus" of the power supply unit, brown wire is a "minus" of the power supply unit).
4	Switch on the scanner controller by pressing the power button.	4	Make network settings as described in the previous section.
		5	Supply power to the system (9...30 V, or 12...39 V for scanners with blue laser).

NOTE 1: Within 8 seconds after powering on, the FPGA firmware is booting and the Ethernet interface is initializing (the red LED blinks). After that, the system is ready to operate (the green LED blinks).

NOTE 2: To turn off the system, press the power button on the controller, or turn off the power supply (for the system without controller).

13. Setting parameters of the scanner

To configure parameters of laser scanners RF627Weld, you can use both the web page or the Riftek Lamia software. For more information, read sections [14](#) and [15](#).

14. Web page

The web page is intended to check the operation and configure parameters of the scanner. To access the web page, enter the IP address of the scanner into the address bar of the web browser:

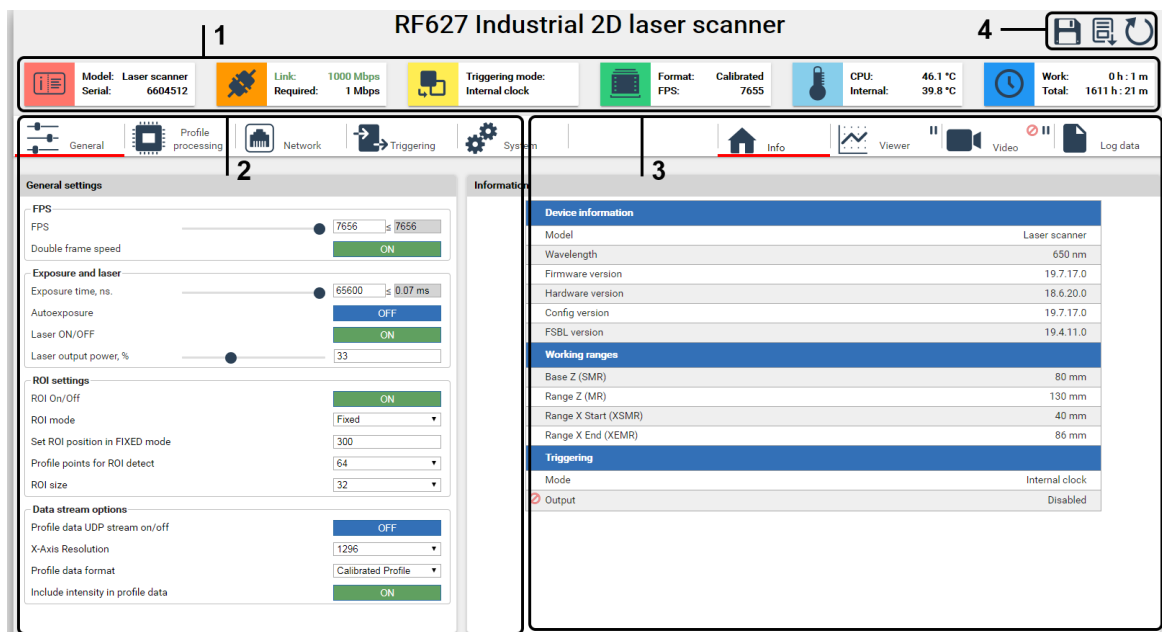







The web page contains four areas (shown above):

1. Scanner status indicators.
2. Parameterization tabs.

3. Result and status display tabs.

4. Control buttons.

Area 1 contains the following indicators:

Icon	Name	Description
	Device info	Model name and serial number of the scanner. Serial number is a unique identifier of the scanner and is assigned by the manufacturer.
	Connection status	The status of connection with the scanner. If the connection is established, the Link caption and the connection speed value will be displayed in this field. The Required caption displays the recommended connection speed required for correct operation of the device. The recommended speed depends on the operation mode of the scanner. If communication with the scanner is lost (for example, when the scanner is restarted or the connection is broken), the web page will be displayed, but the connection status will change to Disconnected .
	Triggering mode	Measurement triggering mode, in which the scanner is operating now.
	Profile settings	The current profile data format (Format) and the current number of profiles per second (FPS) sent by the scanner via the UDP protocol. The value may vary depending on the operating mode of the scanner and its settings.
	Temperature °C	Processor temperature (CPU) and internal temperature of the scanner (Internal) in °C. This information is used to assess the operating conditions of the scanner. Do not allow the temperature to rise to 90°C or more. When the permissible temperature is exceeded, the indicator starts blinking.
	Total work time	Operating time after switching on (Work) and total operating time of the scanner (Total).





Area 2 contains the following tabs:

- **General.** General scanner settings, including parameters of CMOS-sensor and data streams.
- **Profile processing.** Profile processing settings and control of profiles accumulation in scanner memory.
- **Network.** Network settings of the scanner.
- **Triggering.** Settings of input channels of the scanner (triggering modes) and output channel for synchronization of work of several scanners.
- **System.** System settings of the scanner, including support for compatibility modes, etc.

Area 3 contains the following tabs:

- **Info.** General information about the scanner (firmware version, working range, etc).
- **Viewer.** Viewing the current profile, or viewing profiles accumulated in internal memory with the ability to display as a 3D point cloud, or viewing the intensity image.
- **Video.** Video signal view.
- **Log data.** Information about the scanner operation.

Area 4 is located in the upper right corner and contains the control buttons:

Button	Name	Description
	Save configuration	Save settings to the flash memory of the scanner.
		The exclamation mark means that the parameters have been changed, but haven't been saved.
	Load defaults	Restore the factory settings. Important: It is necessary to restart the scanner after restoring the factory settings. Click the Restart device button.
	Restart device	Restart the scanner.

A detailed description of all settings is given in the User's Manual for Laser Scanners RF627 Series:

https://riftek.com/media/documents/rf627/manual2019/2D_Laser_Scanners_RF627_Series_eng.pdf

15. Riftek Lamia software

The Riftek Lamia software starts automatically after the controller is turned on. For the system without controller, the Riftek Lamia software must be installed on the PC or laptop.

15.1. System requirements

System requirements:

- Operating system Windows 7 and later, or GNU/Linux.
- Video card and video card drivers, which support OpenGL 2.1 and later, or GLES 3.0 and later.

NOTE: To avoid errors in the operation of the Riftek Lamia software, you must install the latest video card driver provided by the manufacturer. If you need help to install the video card driver, contact the manufacturer of the computer or the manufacturer of the video adapter. RIFTEK does not assist in installing the graphics drivers and provides the information in this document solely as advice for troubleshooting.

Radeon video card drivers: <http://support.amd.com/en-us/download>.

GeForce video card drivers: <http://www.geforce.com/drivers>.

Intel video card drivers: <https://downloadcenter.intel.com/product/80939/Graphics-Drivers>.

15.2. Installation

Before starting the installation process, read the following information.

The Riftek Lamia software is designed for 64-bit operating systems. To determine the version of your operating system, refer to the System Properties window or to your system administrator.

Download links:

Windows x64:

https://riftek.com/media/documents/software/lamia/LamiaInstaller_win_x86_64.zip

Linux x64:

https://riftek.com/media/documents/software/lamia/LamiaInstaller_linux_x86_64.zip

To start the installation process, you need to run the setup file:

- LamiaInstaller_win_x86_64.exe, or
- LamiaInstaller_linux_x86_64.run

When you run the setup file, the welcome window of the Setup Wizard appears. In this window, you need to click **Next >** and follow the guidelines in dialog boxes of the Setup Wizard.

15.3. User's interface

15.3.1. Main window



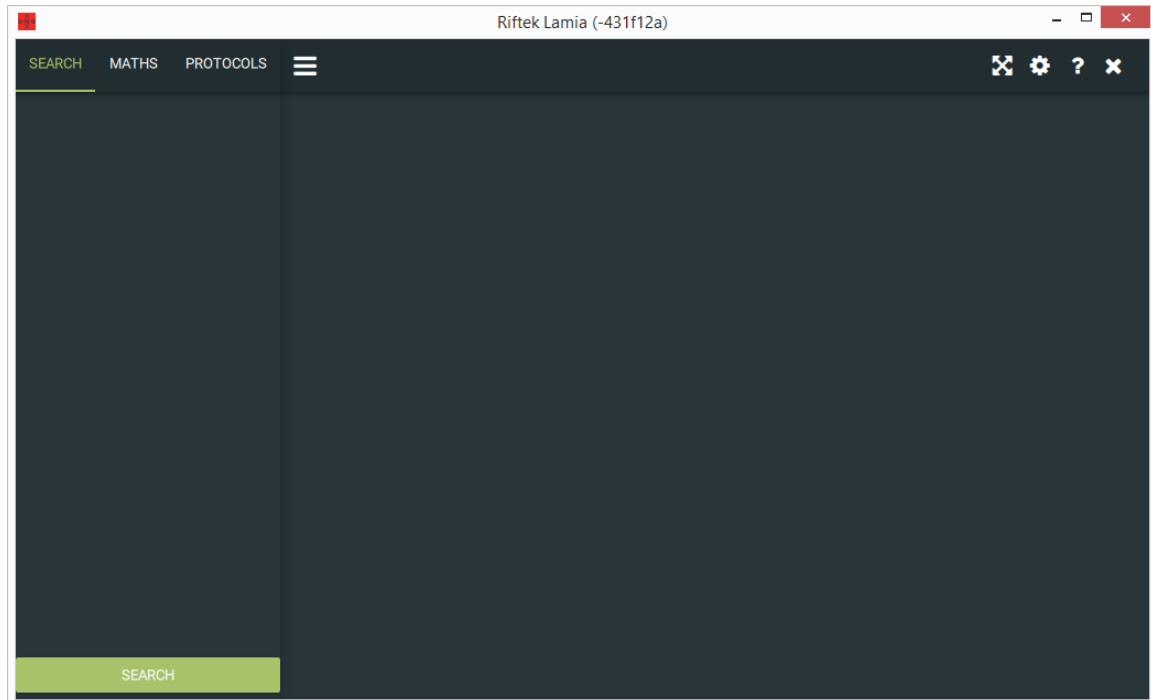



The main window:



Main tabs:

Tab	Description
SEARCH	Search for scanners and connection.
MATHS	Seam tracking and measurement.
PROTOCOLS	Protocols for communication with industrial robots.

Toolbar:

Icon	Assignment
	Hide / show the left panel.
	Switch to the full screen mode.
	Exit the full screen mode.
	Open the "Settings" window: application settings, language selection, and so on.
	Open the "About" window: information about Riftek Lamia, license activation.
	Close Riftek Lamia.

15.3.2. "Settings" window

To open the **Settings** window, click  in the toolbar. The **Settings** window:

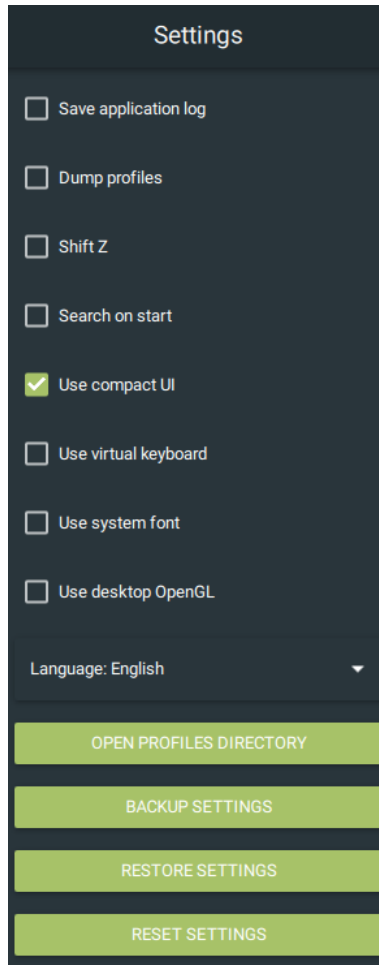

Program settings:

Item	Description
Save application log	Saving the application log to a file (app-log.txt).
Dump profiles	Saving each profile to a separate CSV file.
Shift Z	Shifting the obtained profile down by 50% of the Z range. This option must be enabled before establishing a connection with special scanners that have the Z coordinate values inverted.
Search on start	Enabling automatic search for scanners on the network when the application starts.
Use compact UI	Enabling the desktop version of the user interface.
Use virtual keyboard	Using the virtual keyboard.
Use system font	Using the operating system font in Riftek Lamia.
Use desktop OpenGL	Providing direct access to graphic equipment. This option accelerates the rendering speed for the user interface elements.
Language	Language selection.
OPEN PROFILES DIRECTORY	Opens a directory with profile files.
BACKUP SETTINGS	Saves the current user settings to backup.
RESTORE SETTINGS	Restores settings from backup.
RESET SETTINGS	Resets all program settings to factory settings: all user settings will be deleted, and the license will be deactivated.

15.3.3. "About" window

To view information about **Riftek Lamia**, click  in the toolbar. The **About** window:

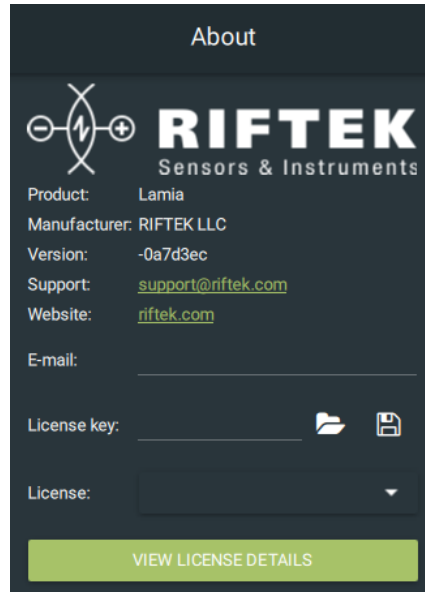

To activate the license, enter the email and the license key into the appropriate fields.

The program allows the user to download the activation key from a file. To do this, click the button  and then select the file with the activation key.

To save the activation key to a file, click .

To view information about the license, click **VIEW LICENSE DETAILS**. The information is presented on three tabs:

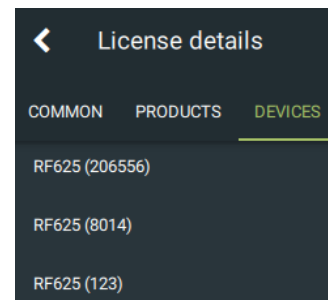
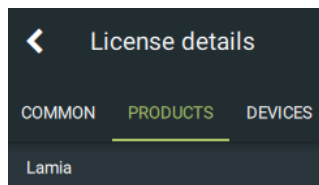
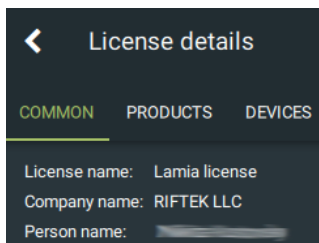

15.3.4. Keyboard shortcuts

Alt + 1	Switching to the SEARCH panel.
Alt + 2	Switching to the MATHS panel.
Alt + 3	Switching to the PROTOCOLS panel.
Ctrl + B	Switching to the Background maths mode. In this mode, the lines will be displayed on the profile.
Ctrl + F	Starting search for devices.
Ctrl + H	Hide / show the left panel.
Ctrl + Q	Close Riftek Lamia.
Ctrl + Shift + O	Calling the Settings window.
F1	Calling the About window.
F11	Switching to the full screen mode.

15.4. "SEARCH" tab. Search, connection and settings

15.4.1. Search for scanners

To start searching for the scanners, click the **SEARCH** button, or use the keyboard shortcut **Ctrl + F**. In addition, you can enable the **Search on start** option in the **Settings** window in order to start the search automatically when you start the program.

When the scanner is detected, the program activates the connection panel:

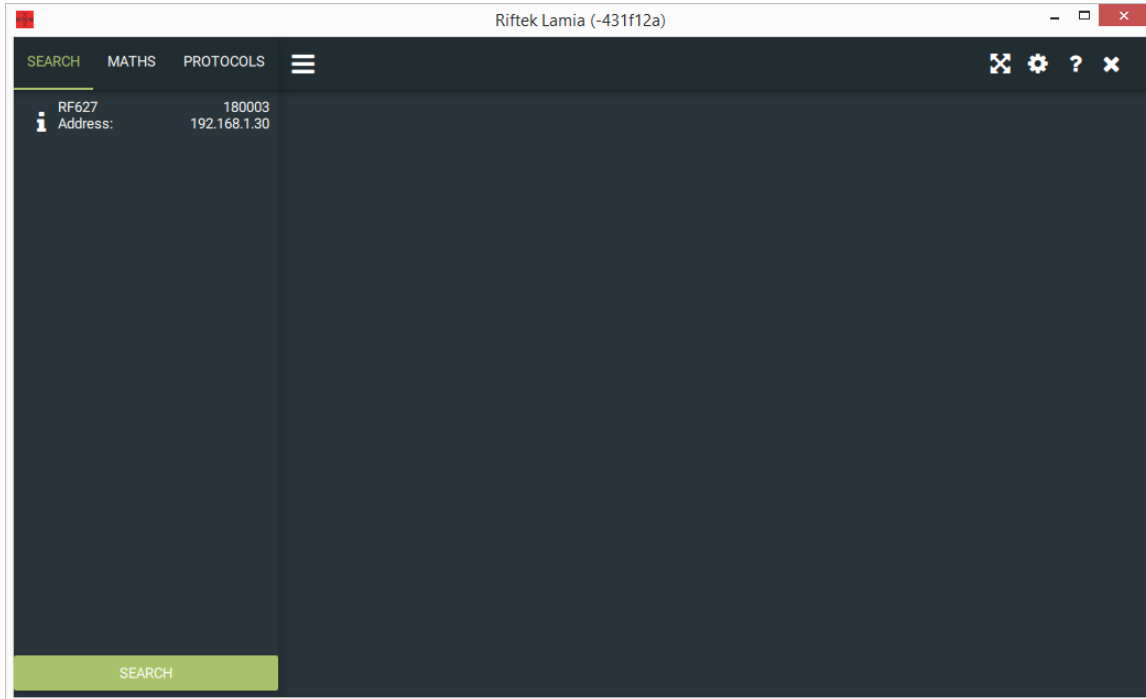

This panel displays the scanner series (RF627), serial number (180003), and IP address (192.168.1.30). To view additional information, click on the "i" icon:

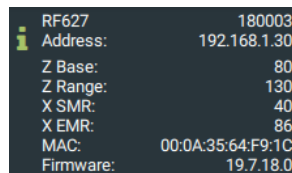

Information about the scanner:

Address	IP address of the scanner.
Z Base	Base distance, mm.
Z Range	Measurement range, mm.
X SMR	The range by X coordinate at the beginning of the working range by Z, mm.
X EMR	The range by X coordinate at the end of the working range by Z, mm.
MAC	MAC address.
Firmware	Firmware version.

15.4.2. Connection



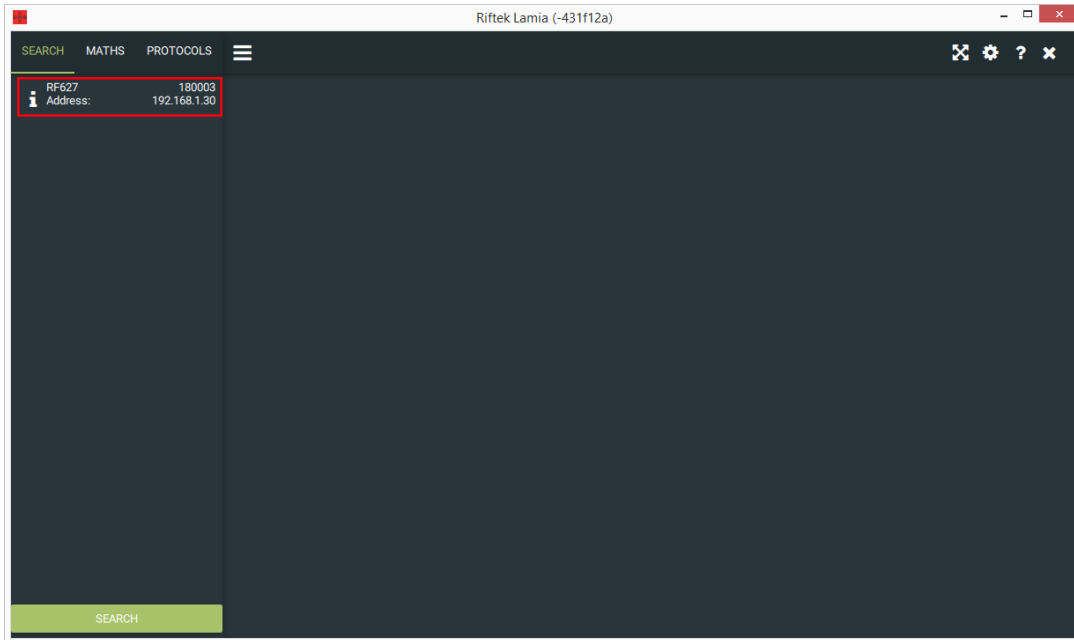

To connect to the scanner, click on the connection panel:

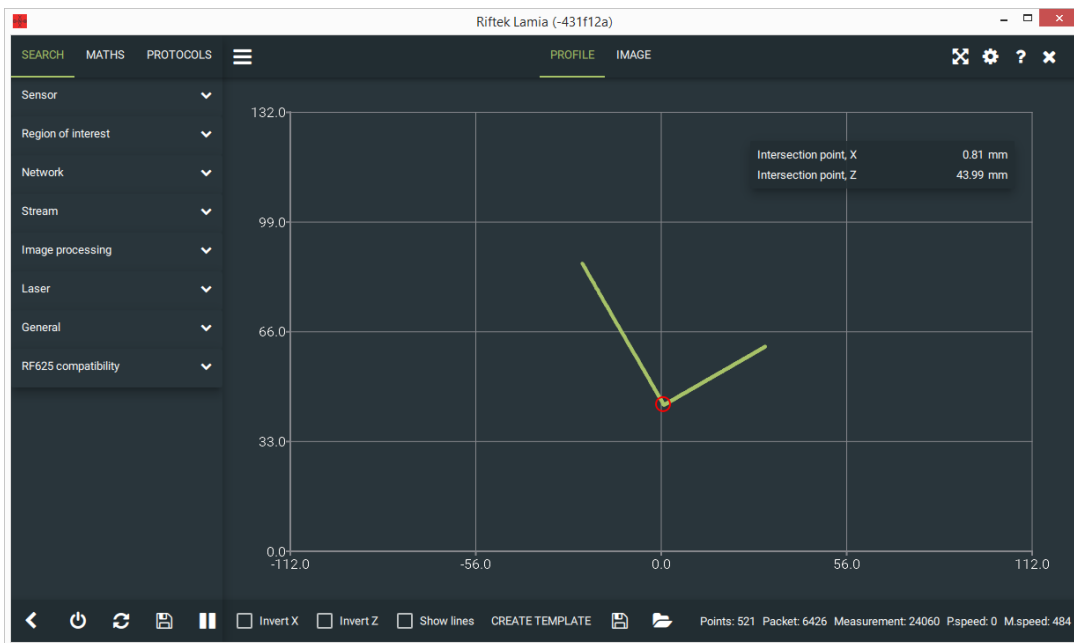



Upon successful connection, you will see the scanner parameters on the left side of the window, the **PROFILE** and **IMAGE** tabs, and the obtained profile:



Scanner parameters are described in the following paragraphs.
Buttons assignment:

Button	Assignment
	Disconnect from the scanner and return to the list of detected devices.
	Restart the scanner.
	Save the settings to the non-volatile memory of the scanner.
	Stop receiving a profile.

Tools for working with the profile:

Tool	Description
Invert X	Invert the profile along the X axis.
Invert Z	Invert the profile along the Z axis.
Show lines	Display the lines on the profile.
CREATE TEMPLATE	Create a math template from profile lines. A detailed description is given in par. 15.5.7.
	Save the current profile or measurement.
	Open the folder with saved profiles or the folder with saved measurements.

The status line in the lower part of the window displays:

Points	The number of points in the profile.
Packet	The number of packets sent by the scanner (internal counter of the scanner).
Measurement	The number of profiles measured by the scanner (internal counter of the scanner).
P.speed	Packet reception rate.
M.speed	Measurement speed.

You can hide the **SEARCH** tab by clicking the button  or by using the keyboard shortcut **Ctrl+H**:

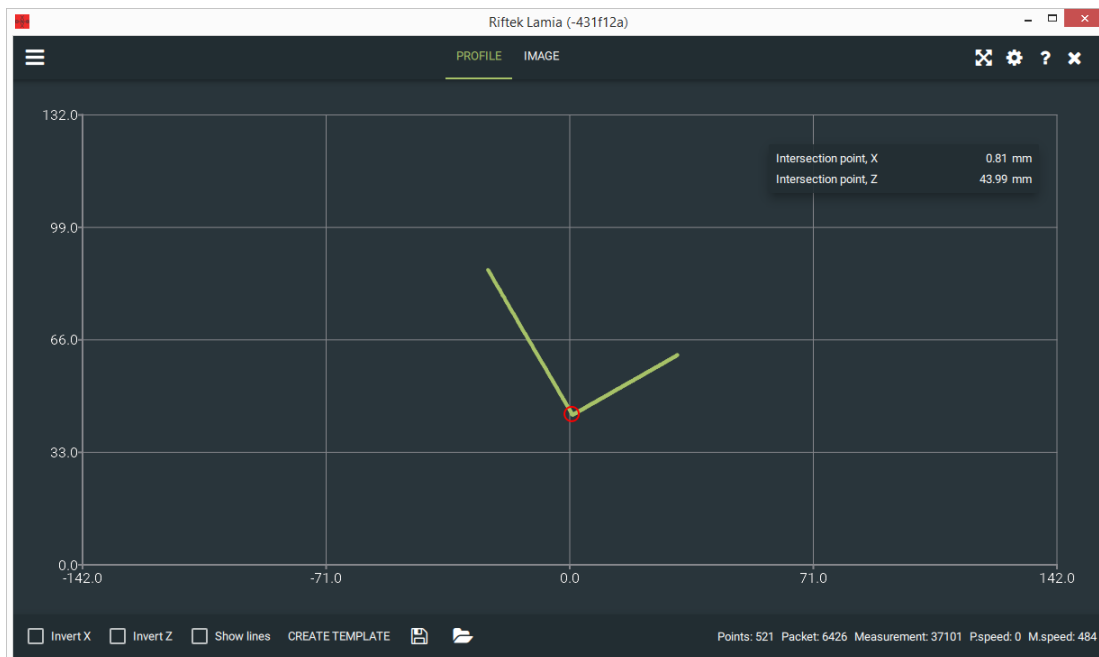

By moving the object or the scanner, you can observe changes in the profile.

Zooming is done by rotating the mouse wheel. To return to the original scale, double-click on the visualization area. To move a profile, you need to left-click on the profile and, holding the button pressed, drag it.

The scanner can operate in the image transmission mode. The image transmission rate is about 10 frames per second.

To switch to the image observation mode, go to the **IMAGE** tab:

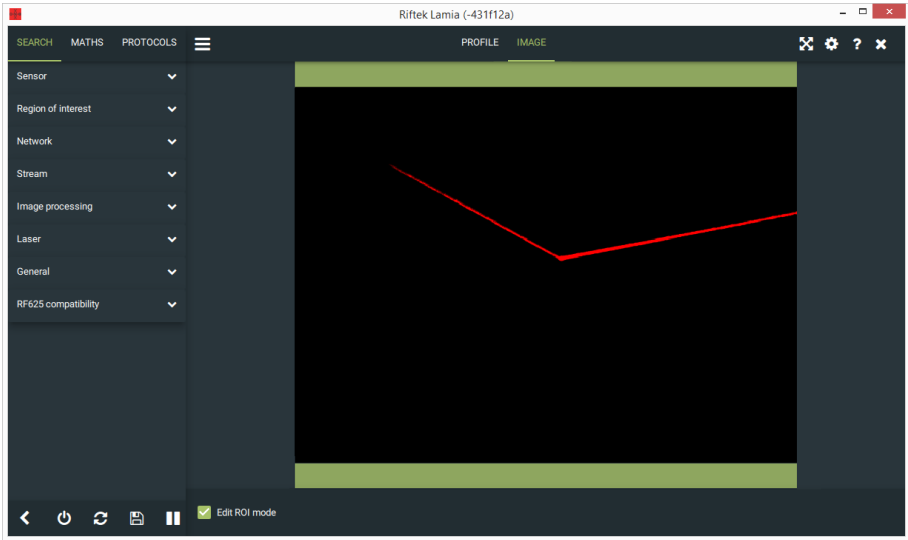

15.4.3. Setting parameters

15.4.3.1. Procedure

Connect to the scanner by clicking on the connection panel. Then expand the parameters panel you need and make changes. All settings, except for network parameters, are applied immediately. For the network parameters to take affect, you need to click  and restart the scanner.

All changes are made in RAM and will be lost when you restart the scanner. Always save them to the nonvolatile memory before restarting the scanner.

15.4.3.2. Parameters

15.4.3.2.1. "Sensor" panel

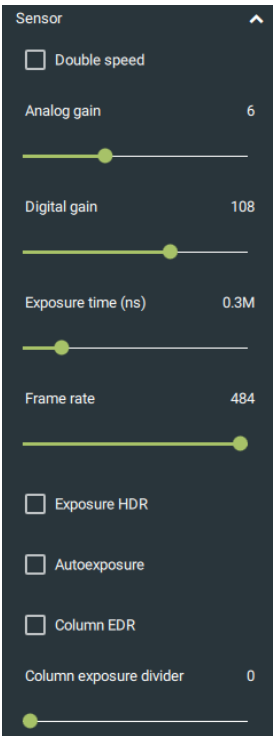

Parameter	Factory value	Description
Double speed	OFF	Enable / disable the double frame rate mode: <ul style="list-style-type: none"> • ON - enabled, the scanner works in DS mode; • OFF - disabled, the scanner works in standard mode. Note: In this mode, the linearity of the scanner for Z is reduced from $\pm 0.05\%$ to $\pm 0.1\%$ of the measuring range for Z.
Analog gain	6	Analog gain of the signal generated by each pixel of the image. Valid values: from 1 to 15.
Digital gain	108	Digital gain of the signal generated by each pixel of the image. Valid values: from 96 to 114.
Exposure time (ns)	300000	The exposure time of the CMOS sensor (signal accumulation time) in nanoseconds, step - 10 ns. The minimum value is 3000 ns, the maximum possible value depends on the frame rate, the ROI and DS modes, and is limited to 1/FPS. Note: The laser automatically turns on during the exposure time only.
Frame rate	484	The current number of profiles (frames) per second that the scanner processes and transmits.
Exposure HDR	OFF	This mode is designed to expand the dynamic range of the sensor. It is used in the control of complex objects containing areas with different reflectivity. The expansion of the dynamic range is achieved due to the use of a piecewise linear response of the CMOS sensor.
Autoexposure	OFF	Enable / disable the autoexposure mode: <ul style="list-style-type: none"> • OFF - manual mode; • ON - autoexposure mode.
Column EDR	OFF	This mode is designed to expand the dynamic range of the sensor. It is used in the control of complex objects containing areas with different reflectivity. The expansion of the dynamic range is achieved due to different exposure times for the even and odd columns of the CMOS sensor. For odd columns, the exposure time is lower. Exposure time reduction is determined by the Column exposure divider coefficient.
Column exposure divider	5	Exposure time reduction coefficient for odd columns of the CMOS sensor. It determines how many times the exposure time for odd columns is reduced relative to the main exposure time. It is available only when the Column EDR mode is enabled. Possible values: 5, 10, 15, 20.

15.4.3.2.2. "Region of interest" panel

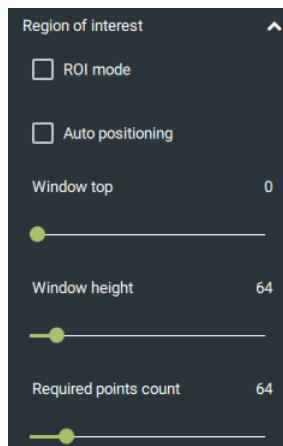

Parameter	Factory value	Description
ROI mode	OFF	Enable/disable the ROI mode: <ul style="list-style-type: none"> • ON - enabled; • OFF - disabled.

Parameter	Factory value	Description
		When this mode is enabled, the CMOS sensor processes a part of the active area set by the Window top and Window height parameters. The frequency of profiles increases inversely with the size of the region of interest (Window height).
Auto positioning	OFF	Automatic control of the position of the region of interest. The region of interest automatically moves within the working range of the scanner in order to keep the profile image within the boundaries of the specified area. This mode makes it possible to work in the entire working range of the scanner with the increased speed. Note: If this mode is enabled, the position of the region of interest is fixed and is determined by the Window top parameter. The size of the area is determined by the Window height parameter.
Window top	300	The position of the upper boundary of the region of interest in manual mode. Valid values: from 0 to (488 - Window height).
Window height	64	The size of the region of interest. Valid values: from 24 to 480.
Required points count	324	This parameter is active in the Auto positioning mode. It sets the number of points in the profile, which indicates that the profile is located within the region of interest. If the number of points in the region of interest is less than the specified value, the scanner automatically starts searching for the profile on the entire field of the CMOS sensor (the region of interest expands to the entire CMOS sensor with a corresponding change in speed). When the specified number of profile points is detected, the scanner automatically returns to the specified ROI size. Valid number of points: from 1 to 648. The size of the region of interest is determined by the Window height parameter. The Window top parameter is changed automatically.

15.4.3.2.3. "Network" panel

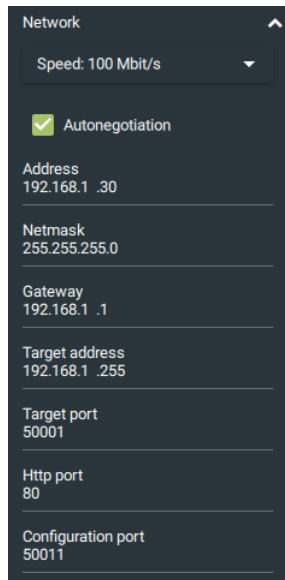

Parameter	Factory value	Description
Speed	-	Connection speed. Available modes: <ul style="list-style-type: none"> • 100 Mbps; • 1 Gbps.
Autonegotiation	ON	Automatic negotiation of connection speed.
Address	192.168.1.30	IP address of the scanner.
Netmask	255.255.255.0	Subnet mask.

Parameter	Factory value	Description
Gateway	192.168.1.1	Gateway address.
Target address	192.168.1.2	IP address of the PC (or other network device) receiving profiles.
Target port	50001	Port number of the PC (or other network device) receiving profiles, to which the scanner must send UDP packets with profiles.
Http port	80	Scanner port number for connecting via HTTP to access the scanner web page.
Configuration port	50011	Scanner port number for the service protocol.

 In order for the changes to take effect, it is necessary to save them to the nonvolatile memory of the scanner and then restart the scanner.

15.4.3.2.4. "Stream" panel

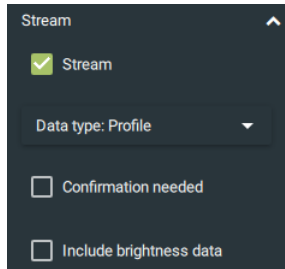

Parameter	Factory value	Description
Stream	ON	Enable/disable the UDP data stream.
Data type	Profile	Data transfer formats: pixels, profile, interpolated pixels, interpolated profile.
Confirmation needed	OFF	Enable/disable the requirement to confirm delivery of UDP packets with profiles.
Include brightness data	OFF	Include the point intensity values into the profile package: Note: The data format description is given in the Developer Guide.

15.4.3.2.5. "Image processing" panel

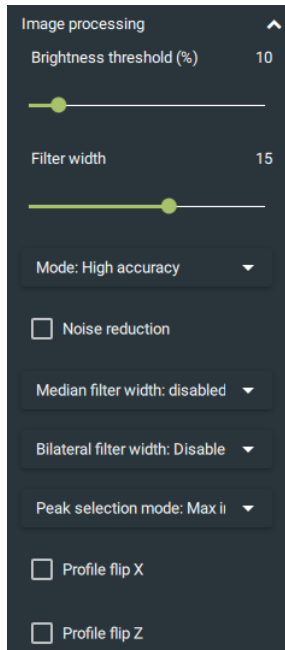

Parameter	Factory value	Description
Brightness threshold (%)	10	The level of profile detection on the image. Increasing this parameter allows to decrease the influence of image noise. Range of values: 0...100%. If the value is "100%", the image is not processed.
Filter width	25	The width of the filter for primary processing of image points. Valid values: from 1 to 25.
Mode	High accuracy	Two modes are available: High accuracy and Welding. The Welding mode is intended to be used with the scanners installed on welding robots and operating under conditions of strong light interference.
Noise reduction	OFF	Removing unstable points from the profile. The points are considered unstable if they are not detected at least once in 128 profiles in a row.
Median filter width	Disabled	The size (number of points) of the sliding window of the median filter. Valid values: 0, 3, 5, 7, 9, 11, 13, 15. If the value is "0", the filter is disabled.
Bilateral filter width	Disabled	The size (number of points) of the sliding window of the bilateral smoothing filter. Valid values: 0, 3, 5, 7, 9, 11, 13, 15. If the value is "0", the filter is disabled.
Peak selection mode	Max intensity	The algorithm for determining the peak brightness in the image column to obtain the profile point. It is used to suppress false images resulting from multiple reflections on complex profiles. Modes: <ul style="list-style-type: none"> • Max intensity – Selecting the peak with the greatest brightness. • First – Selecting the first peak in the column above. • Last – Selecting the last peak in the column above. • Index 2...6 – Selecting the peak with the corresponding number.
Profile flip X	OFF	Flip the profile along the X axis of the scanner.
Profile flip Z	OFF	Flip the profile along the Z axis of the scanner.

15.4.3.2.6. "Laser" panel

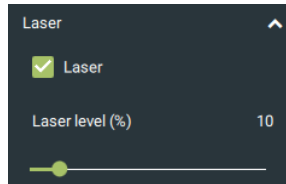

Parameter	Factory value	Description
Laser	ON	Turn on / off the laser.
Laser level (%)	10	Laser output power level. Range of values: 0...100%.

15.4.3.2.7. "General" panel

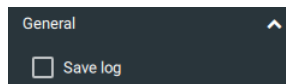

Parameter	Factory value	Description
Save log	ON	Recording information about the operations performed.

15.4.3.2.8. "RF625 compatibility" panel

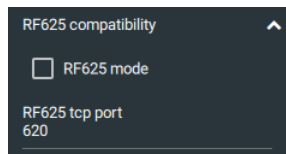

Parameter	Factory value	Description
RF625 mode	OFF	Compatibility with RF625 scanners.
RF625 tcp port	620	TCP port of the RF625 scanner.

15.5. "MATHS" tab. Selecting a template for seam tracking

15.5.1. General information

The **MATHS** panel contains two sets of built-in templates: **Measurement** and **Welding**. By default, the **Measurement** set is selected. To work with the **Welding** set, click on the list of sets at the lower left corner of the window and select **Welding**. You will see:



Riftek Lamia automatically recognizes the weld seam for tracking in accordance with the selected math algorithm (template). There is no need to set the tracking area manually.







To select a template, you need to click on its icon. After selecting, **Riftek Lamia** automatically finds an appropriate profile and displays the calculated parameters. These parameters are sent to the robot controller in accordance with the selected protocol.

The user can configure template settings, change the order, remove unnecessary templates, or add the new ones.

The area of templates contains the button intended to add templates to the area -



The toolbar description:

Element	Description
	Apply the math algorithm (template). If you disable this option, the area of templates will not be active.
	The Robot view option. When this option is enabled and connection with the robot is established, the template requested by the robot will be selected automatically. When the Robot view option is enabled, the area of templates is not active.
	Restore a default set of templates.
	Show template settings.
	Copy the selected template.
Set	Select a set of templates: Welding or Measurement.
	Edit mode.

15.5.2. Search parameters ("SEARCH" tab)

The image obtained from the scanner is not an exact copy of the object profile and may contain gaps, false images and noises caused by, for example, the surface heterogeneity, laser reflections, influence of the external light sources and electrical noise, and so on. Optimal search parameters make it possible to find the profile on the image, which is the most similar to the selected template.

To configure search parameters, it is necessary to double-click on the template icon, or click one time and then click . The search parameters are displayed on the **SEARCH** tab:

29

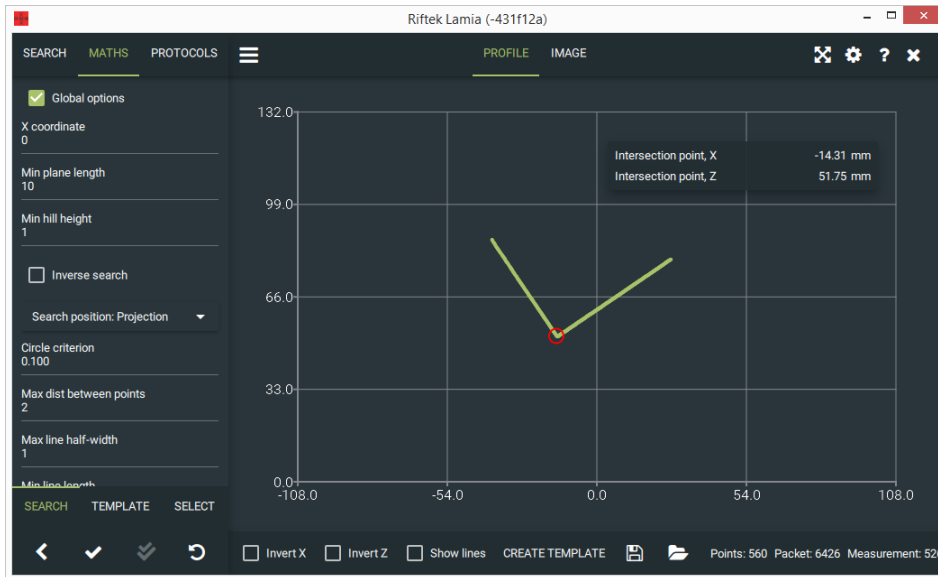

Buttons assignment:

Button	Assignment
	Go back to the main panel.
	Save and apply changes for the selected template.
	Save and apply changes of some parameters for all templates (works only for "Invalid sequence", "Search distance", "2D offset X", "2D offset Z"). This button will be active after clicking .
	Reset all changes to the last saved settings.

Search parameters:

Parameter	Factory value	Description
Global options	On	Select this option to display and use global (common) search parameters for all templates, or disable this option to set different search parameters for templates.
X coordinate	0	X coordinate of the profile point in accordance with which the Y coordinate will be calculated.
Minimum plane length	10	The minimum length of a plane area on the profile. Unit of measurement - millimeters.
Minimum hill height	1	The minimum height of the hill area over the flat area. Unit of measurement - millimeters.
Inverse search	Off	Invert the Z coordinate.
Search position (Projection, Center of	Projection	Search for a point in accordance with the set position: Projection – a projection of the highest point onto a plane, Center of mass – a center

Parameter	Factory value	Description
mass, Top, Butt center)		of mass of a hill, Top – the highest point, Butt center - a middle point between two joining surfaces.
Circle criterion	0.1	The maximum value of the circle quality, with which a profile will be defined as a circle. The circle quality = the standard deviation of the profile points from the circle / circle radius. The range of values: 0..1 (the higher the value, the "worse" the circle). The "0" value is supposed to be set for detecting a perfect circle.
Maximum distance between points*	2	* See a description in the Table below.
Maximum line half-width*	1	
Minimum line length*	4	
Cut-Off border state	Off	Enable / Disable the border, beyond which the found points are not valid.
Cut-Off border range, %	5	The size of the cut-off border. This parameter specifies a percentage of reducing the range of valid values.
Search distance	15	The distance from the previous point, within which the emergence of a new point is valid. Unit of measurement - millimeters.
Invalid sequence	20	The number of invalid points. The points are considered invalid if the distance between these points is greater than the "Search distance". After the end of the invalid sequence, a new point will be taken as valid.
Search range	1.5	The tolerance for the "X coordinate" parameter. Unit of measurement - millimeters.
3D offset X	0	3D offset of one point selected in the "Select" tab. These parameters are applied only for the Riftek P2 protocol.
3D offset Y	0	
3D offset Z	0	
2D offset X	0	2D offset of all points selected in the "Select" tab. These parameters are applied for all protocols.
2D offset Z	0	

* The scanner obtains a profile as a set of points. When searching for a template in a profile, the software combines points into contour lines in accordance with the rules described in the Table below.

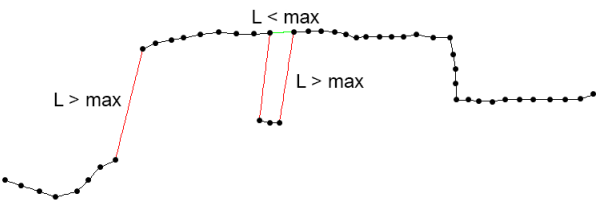
Rule	Description
Maximum distance between points	This rule sets the maximum distance between points along Z axis. If the distance between points is less than this value, these points will be taken as one contour line. Unit of measurement - millimeters. An example of splitting the profile into contour lines: 
Maximum line half-width	This rule sets the maximum distance from a point to a line. If the distance is less than this value, the point will be considered belonging to this line. Unit of measurement - millimeters.
Minimum line length	This rule sets the minimum length of the line. All lines, which less than this value, will be considered as a noise, and will be cut off. Unit of measurement - millimeters.



When you have changed search parameters, it is necessary to save them in order for the changes to take effect.

15.5.3. Template parameters ("TEMPLATE" tab)

Templates consist of the lines (profile lines that the scanner "sees"). These lines are numbered starting from "0". The length and position of the lines are determined by special parameters called *constraints*. To view / configure template parameters, double-click on the template icon and go to the **TEMPLATE** tab.

The **TEMPLATE** tab contains a list of constraints that form a template description.

Each constraint is shown as follows:

- Name of the constraint.
- Line index (starts from 0).
- Parameters for the specific constraint type.



When you have changed template parameters, it is necessary to save them in order for the changes to take effect.

There are six types of constraints:

1. Line length

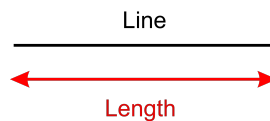

The constraint of the line length (L). This constraint is defined by the lower and upper boundaries set in millimeters ("Minimum" and "Maximum" fields respectively). One or both boundaries may be set as "Undefined".

2. Endpoint distance

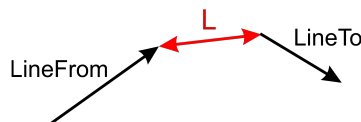

The constraint of the distance (L) from the end of one line (*LineFrom*) to the start of another line (*LineTo*). This constraint is defined by the lower and upper boundaries set in millimeters ("Minimum" and "Maximum" fields respectively). One or both boundaries may be set as "Undefined".

3. Rotation angle

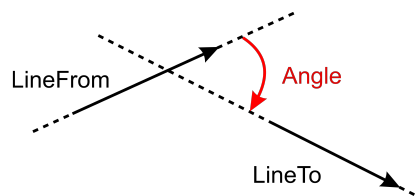

The constraint of the angle of rotation (*Angle*) in degrees from one line (*LineFrom*) to another line (*LineTo*). This constraint is defined by the lower and upper boundaries set in millimeters ("Minimum" and "Maximum" fields respectively), and by the direction of rotation. If any of the constraints is absent, set the values "Undefined" and "None" for lower / upper boundaries and for the direction of rotation respectively.

NOTE: The minimum and maximum values of the angle of rotation can vary in the range of 0 to 180°.

4. Endpoint shift in direction

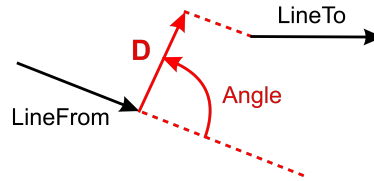

The constraint of shift of the starting point of a line (*LineTo*) relative to the end of another line (*LineFrom*). This constraint is defined by the lower and upper boundaries set in millimeters ("Minimum" and "Maximum" fields respectively). If any of the constraints is absent, it must be set as "Undefined". The direction of shift is defined by "Angle" that varies in the range of -180° to 180° counterclockwise relative to the *LineFrom* line (if the **Angle from the starting line** checkbox is selected), or to the *LineTo* line (if the **Angle from the starting line** checkbox is not selected).

5. Endpoint distance with check

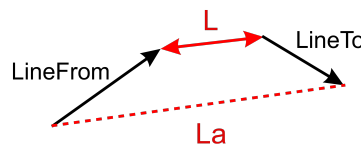

This constraint is similar to *Endpoint distance*, but has an additional verification on the subject that the distance (*L*) from the end of one line (*LineFrom*) to the start of another line (*LineTo*) is less than the distance between other ends (*La*). This prevents the situation, in which the wrong lines can be used, because formally they can fit in the constraints.

6. Inclination angle

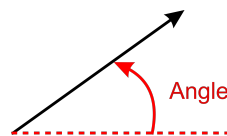

The constraint of the inclination angle (*Angle*). This constraint is defined by the lower and upper boundaries ("Minimum" and "Maximum" fields respectively). If any of constraints is absent, it must be set as "Undefined".

NOTE: The values can vary in the range of -180° to 180° , positive values correspond to the counterclockwise rotation.

15.5.4. List of measurements ("SELECT" tab)

The **SELECT** tab contains a list of measurements for the selected template.

 When you have changed a list of measurements, it is necessary to click in order for the changes to take effect.

There are nine measurement types:

1. Line length

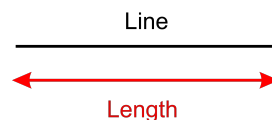

The line length in mm.

2. Intersection point

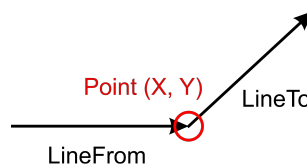

The coordinates (X, Y) of the intersection point.

3. Rotation angle

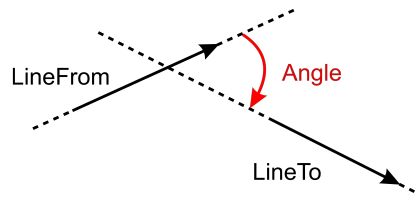

The rotation angle (*Angle*) between the *LineFrom* line and the *LineTo* line.

4. Line point

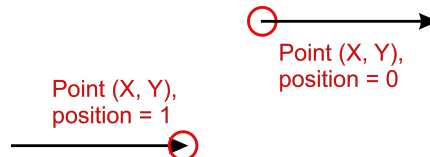

The coordinates (X, Y) of a specific point on the line. This measurement is defined by the "position" parameter, where "0" is the start of the line, and "1" is the end of the line (values outside of the range [0; 1] are possible).

5. Far line in direction

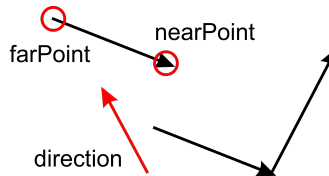

The coordinates of the two extreme points of the farthest line (*farPoint* and *nearPoint*), and the inclination angle of this line. The direction is defined by a nonzero vector ("direction"), the rotation angle of which is measured counterclockwise and varies in the range from -180° to 180° .

6. Angle between lines

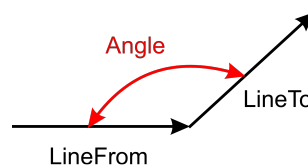

The angle between lines *LineFrom* and *LineTo* from above. The values can vary in the range from 0° to 360° .

7. Inclination angle

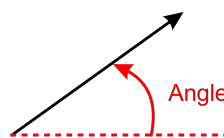

The inclination angle (*Angle*) of the line. The values can vary in the range from -180° to 180° ; positive values correspond to the counterclockwise rotation.

8. Point between 2 points

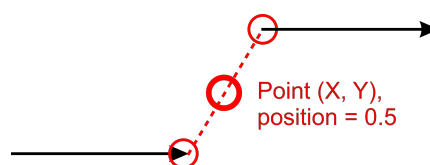

The measurement of the point position on the line between other two points. This position is defined by the "position" parameter, where "0" is the start of the line, and "1" is the end of the line.

9. Endpoint shift in direction

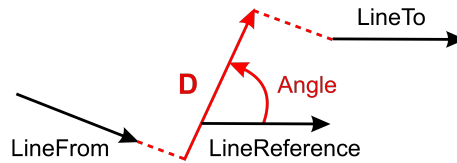

The measurement of the endpoint shift (D) of the *LineTo* line relative to the endpoint of the *LineFrom* line along the direction. The direction of shift is defined by the angle (*Angle*), which is measured counterclockwise relative to the *LineReference* line and varies in the range from 180° to 180° .

15.5.5. Built-in templates

The software offers two sets of built-in templates: **Measurement** and **Welding**.

By default, the software shows the **Measurement** set. To change a set, click on the list of sets at the lower left corner of the window and select **Welding**.

Every template description contains a table with the following columns:

- *Constraints* - a list of constraints applied for this template (see p. [15.5.3](#)).
- *Measurements* - a list of measurements performed by this template (see p. [15.5.4](#)).
- *Parameters* - a list of search parameters applied for this template (see p. [15.5.2](#)).

15.5.5.1. "Measurement" set

15.5.5.1.1. Template 1 "Corner"

Template 1 consists of two lines and calculates the coordinates of the intersection point of these lines.

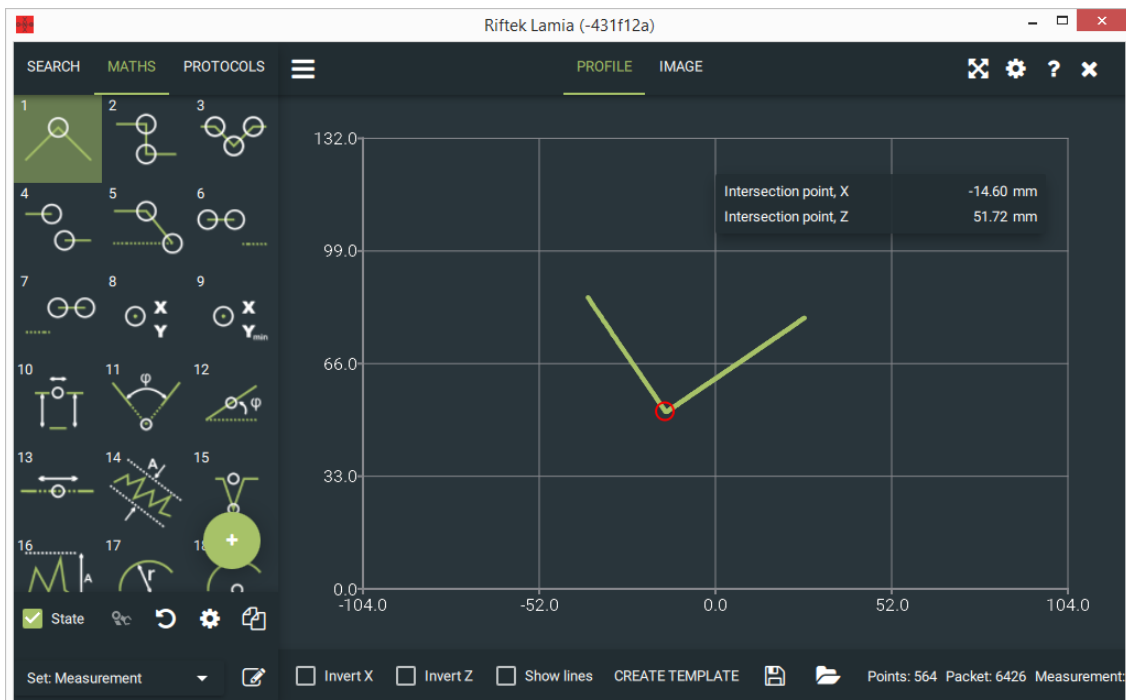

Constraints	Measurements	Parameters
<p>Endpoint distance with check</p> <ul style="list-style-type: none"> Distance between lines 0 and 1; the minimum distance is undefined, the maximum distance is 20 mm. <p>Rotation angle</p> <ul style="list-style-type: none"> Angle of rotation from line 0 to line 1 (30°...150°); the direction of rotation is undefined. 	<p>Lines intersection</p> <ul style="list-style-type: none"> Intersection point of lines 0 and 1. 	-

15.5.5.1.2. Template 2 "Step"

Template 2 consists of three lines and calculates the coordinates of the intersection points of these lines.

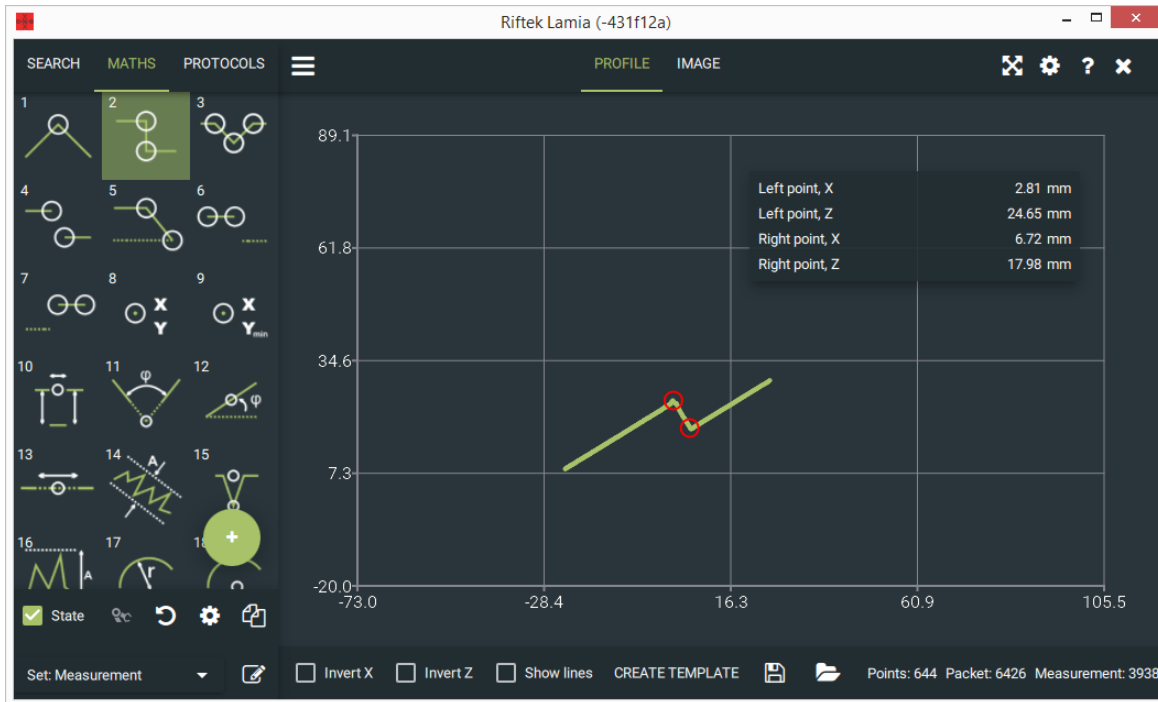

Constraints	Measurements	Parameters
<p>Endpoint distance with check</p> <ul style="list-style-type: none"> Distance between lines 0 and 1; the minimum distance is undefined, the maximum distance is 10 mm. Distance between lines 1 and 2; the minimum distance is undefined, the maximum distance is 10 mm. <p>Rotation angle</p> <ul style="list-style-type: none"> Angle of rotation from line 0 to line 1 (60°...120°); the direction of rotation is undefined. Angle of rotation from line 1 to line 2 (60°...120°); the direction of rotation is undefined. 	<p>Lines intersection</p> <ul style="list-style-type: none"> Left point (intersection point of lines 0 and 1). Right point (intersection point of lines 1 and 2). 	-

15.5.5.1.3. Template 3 "Triangle"

Template 3 consists of four lines and calculates the coordinates of the intersection points of these lines.



Constraints	Measurements	Parameters
<p>Endpoint distance with check</p> <ul style="list-style-type: none"> Distance between lines 0 and 1; the minimum distance is 0 mm, the maximum distance is 1 mm. Distance between lines 1 and 2; the minimum distance is 0 mm, the maximum distance is 1 mm. Distance between lines 2 and 3; the minimum distance is 0 mm, the maximum distance is 1 mm. <p>Rotation angle</p> <ul style="list-style-type: none"> Angle of rotation from line 0 to line 1 (15°...75°); the direction of rotation – right. Angle of rotation from line 1 to line 2 (45°...135°); the direction of rotation – left. Angle of rotation from line 2 to line 3 (15°...75°); the direction of rotation – right. 	<p>Lines intersection</p> <ul style="list-style-type: none"> Left point (intersection point of lines 0 and 1). Top point (intersection point of lines 1 and 2). Right point (intersection point of lines 2 and 3). 	-

15.5.5.1.4. Template 4 "Gap"

Template 4 consists of two lines and calculates the coordinates of the left line endpoint and the starting point of the right line.



Constraints	Measurements	Parameters
<p>Endpoint distance with check</p> <ul style="list-style-type: none"> Distance between lines 0 and 1; the minimum distance is 0.4 mm, the maximum distance is undefined. <p>Rotation angle</p> <ul style="list-style-type: none"> Angle of rotation from line 0 to line 1 (0°...20°); the direction of rotation is undefined. 	<p>Line point</p> <ul style="list-style-type: none"> Left point (endpoint of line 0). Right point (starting point of line 1). 	-

15.5.5.1.5. Template 5 "Right edge"

Template 5 consists of two lines and calculates the coordinates of the extreme points of the rightmost line.

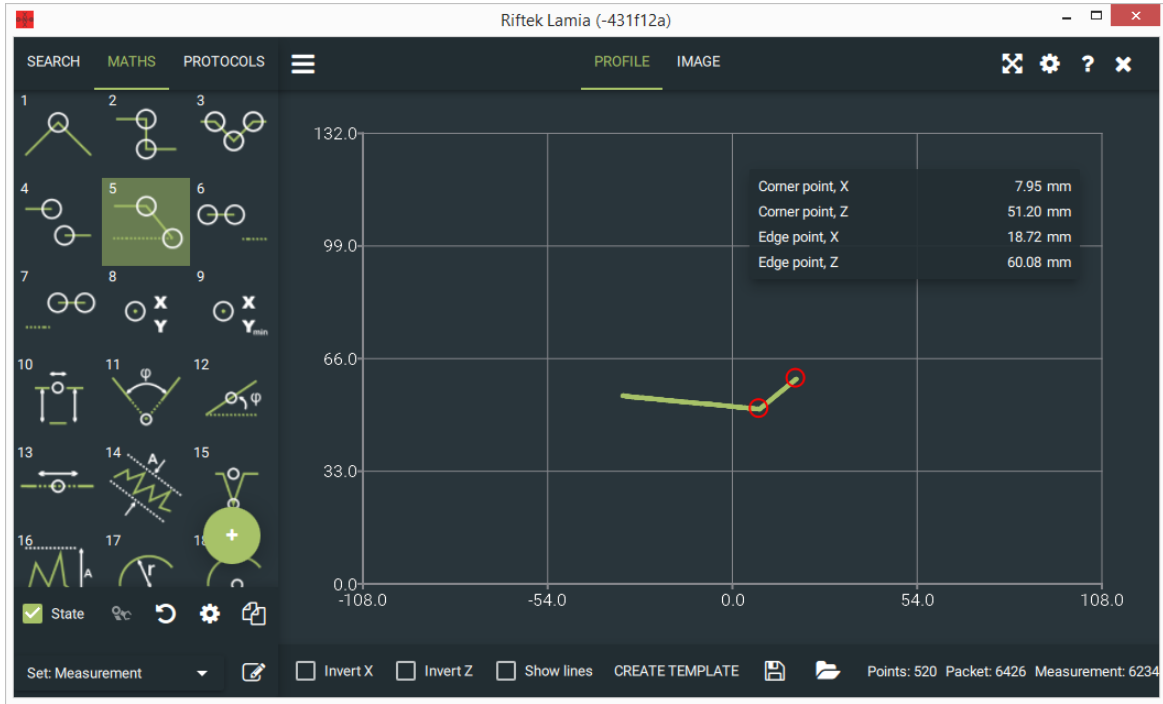

Constraints	Measurements	Parameters
<p>Endpoint distance with check</p> <ul style="list-style-type: none"> Distance between lines 0 and 1; the minimum distance is undefined, the maximum distance is 20 mm. <p>Rotation angle</p> <ul style="list-style-type: none"> Angle of rotation from line 0 to line 1 (30°...150°); the direction of rotation is undefined. 	<p>Lines intersection</p> <ul style="list-style-type: none"> Corner point (intersection point of lines 0 and 1). <p>Line point</p> <ul style="list-style-type: none"> Edge point (end point of line 1). 	-

15.5.5.1.6. Template 6 "Left line"

Template 6 calculates the coordinates of the extreme points of the leftmost line and its angle of inclination.



Constraints	Measurements	Parameters
-	Far line in direction <ul style="list-style-type: none"> • Left point, Right point (extreme points of the leftmost line). • Inclination angle of the leftmost line. 	-

15.5.5.1.7. Template 7 "Right line"

Template 7 calculates the coordinates of the extreme points of the rightmost line and its angle of inclination.



Constraints	Measurements	Parameters
-	Far line in direction <ul style="list-style-type: none"> • Right point, Left point (extreme points of the rightmost line). • Inclination angle of the rightmost line. 	-

15.5.5.1.8. Template 8 "Point"

Template 8 calculates the Z-coordinate of the profile point in accordance with the user-defined X-coordinate. Go to the **Search** tab in order to set the X-coordinate (see par. [15.5.2](#)).

41

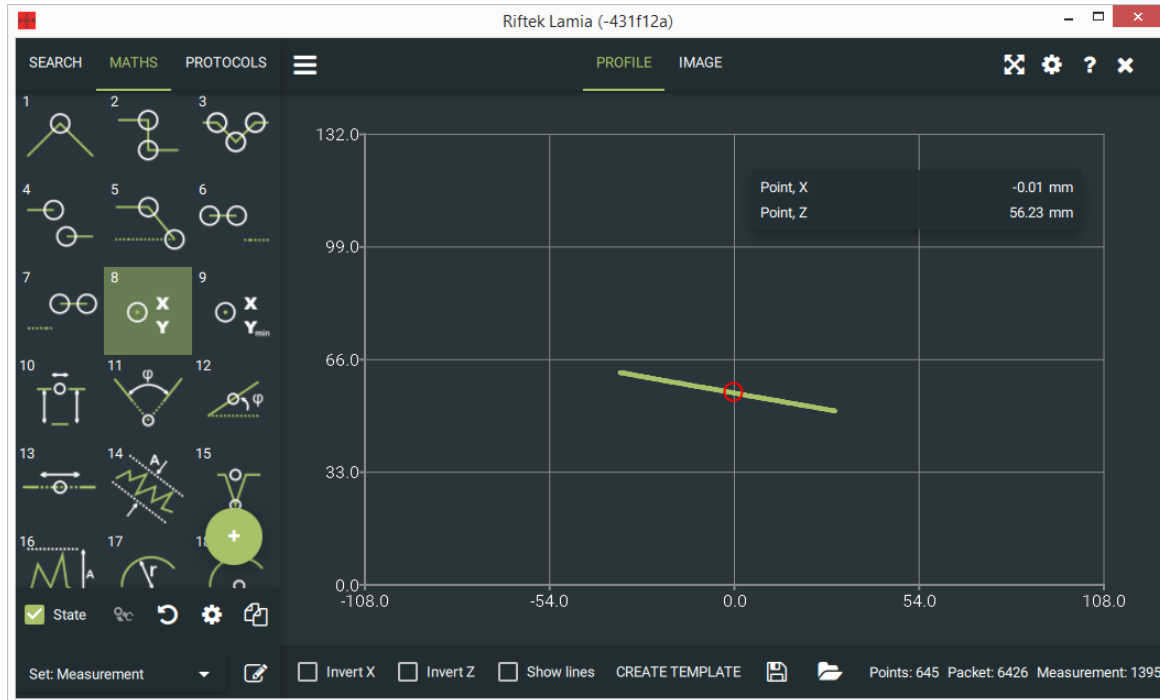

Constraints	Measurements	Parameters
-	<ul style="list-style-type: none"> Z-coordinate of the profile point 	<ul style="list-style-type: none"> X-coordinate of the profile point

15.5.5.1.9. Template 9 "Point, Y min"

Template 9 calculates the X-coordinate of the profile point at the minimum Z-coordinate.



Constraints	Measurements	Parameters
-	<ul style="list-style-type: none"> X-coordinate of the profile point 	-

15.5.5.1.10. Template 10 "Groove"

Template 10 consists of three lines and calculates the height, width and middle of the groove. The height of the groove is calculated by the left and right edges. The width is calculated as the distance between the points, from which the groove begins.

43

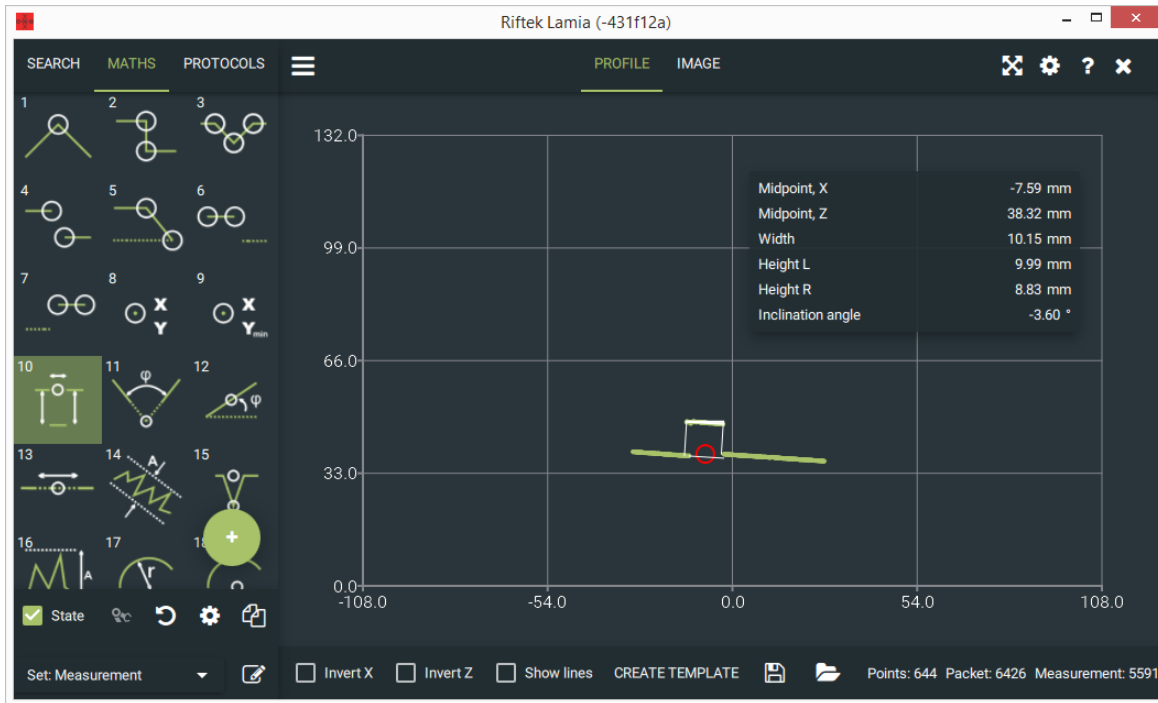

Constraints	Measurements	Parameters
<p>Endpoint shift in direction</p> <ul style="list-style-type: none"> Distance between lines 0 and 1; the minimum distance is 5 mm, the maximum distance is 20 mm, the angle is 90° from the first line. Distance between lines 1 and 2; the minimum distance is 5 mm, the maximum distance is 20 mm, the angle is -90° from the first line. <p>Rotation angle</p> <ul style="list-style-type: none"> Angle of rotation from line 0 to line 1 (must be < 22.5°); the direction of rotation is undefined. Angle of rotation from line 1 to line 2 (must be < 22.5°); the direction of rotation is undefined. 	<p>Point between 2 points</p> <ul style="list-style-type: none"> Midpoint (between the end of line 0 and the start of line 2). <p>Endpoint shift in direction</p> <ul style="list-style-type: none"> Width (distance between the end point of line 0 and the starting point of line 2 at the angle of 0° relative to line 1). Height L (distance between the starting point of line 1 and the end point of line 0 at the angle of 90° relative to line 1). Height R (distance between the end point of line 1 and the starting point of line 2 at the angle of 90° relative to line 1). <p>Inclination angle</p> <ul style="list-style-type: none"> Inclination angle of line 1. 	-

15.5.5.1.11. Template 11 "Angle"

Template 11 consists of two lines, and calculates the angle between these lines, and the coordinates of the intersection point of these lines.



Constraints	Measurements	Parameters
<p>Endpoint distance with check</p> <ul style="list-style-type: none"> Distance between lines 0 and 1; the minimum distance is undefined, the maximum distance is 20 mm. <p>Rotation angle</p> <ul style="list-style-type: none"> Angle of rotation from line 0 to line 1 (30°...150°); the direction of rotation is undefined. 	<p>Lines intersection</p> <ul style="list-style-type: none"> Intersection point of lines 0 and 1. <p>Angle between lines</p> <ul style="list-style-type: none"> Angle between lines 0 and 1. 	-

15.5.5.1.12. Template 12 "Slope"

Template 12 consists of one line and calculates its angle of inclination and coordinates of a middle point.

45



Constraints	Measurements	Parameters
<p>Line length</p> <ul style="list-style-type: none"> Line length; the minimum length is 5 mm, the maximum length is undefined. 	<p>Inclination angle</p> <ul style="list-style-type: none"> Inclination angle of the line. <p>Line point</p> <ul style="list-style-type: none"> Midpoint (a middle point of the line). 	-

15.5.5.1.13. Template 13 "Gap width"

Template 13 consists of two lines that represent the profiles of two surfaces, and calculates the coordinates of a middle point between them and the gap width.



Constraints	Measurements	Parameters
<p>Line length</p> <ul style="list-style-type: none"> Line 0; the minimum length is 20 mm, the maximum length is undefined. Line 1; the minimum length is 20 mm, the maximum length is undefined. <p>Endpoint distance with check</p> <ul style="list-style-type: none"> Distance between lines 0 and 1; the minimum distance is 2 mm, the maximum distance is undefined. <p>Rotation angle</p> <ul style="list-style-type: none"> Angle of rotation from line 0 to line 1; the minimum value is undefined, the maximum value is 10°; the direction of rotation is undefined. 	<p>Point between 2 points</p> <ul style="list-style-type: none"> Midpoint (between the end point of line 0 and the starting point of line 1). <p>Endpoint shift in direction</p> <ul style="list-style-type: none"> Width (distance between the end point of line 0 and the starting point of line 1). 	-

15.5.5.1.14. Template 14 "Amplitude"

Template 14 measures the maximum and minimum height of the surface profile, and calculates the difference between the maximum and minimum values.

The amplitude is calculated relative to the approximated line.



Constraints	Measurements	Parameters
-	<ul style="list-style-type: none"> • Amplitude. • Inclination angle of the line. 	-

15.5.5.1.15. Template 15 "Lowest / Highest point"

Template 15 is intended to track the position of the lowest / highest part of the profile, and to measure parameters of this part (height and width), and the inclination angle of a flat part. The search position can be customized in the **Search** tab (see par. 15.5.2).

By default, this template is in the mode for measuring the lowest part. In order to measure the highest part, it is necessary to select **Inverse search** in the **Search** tab.

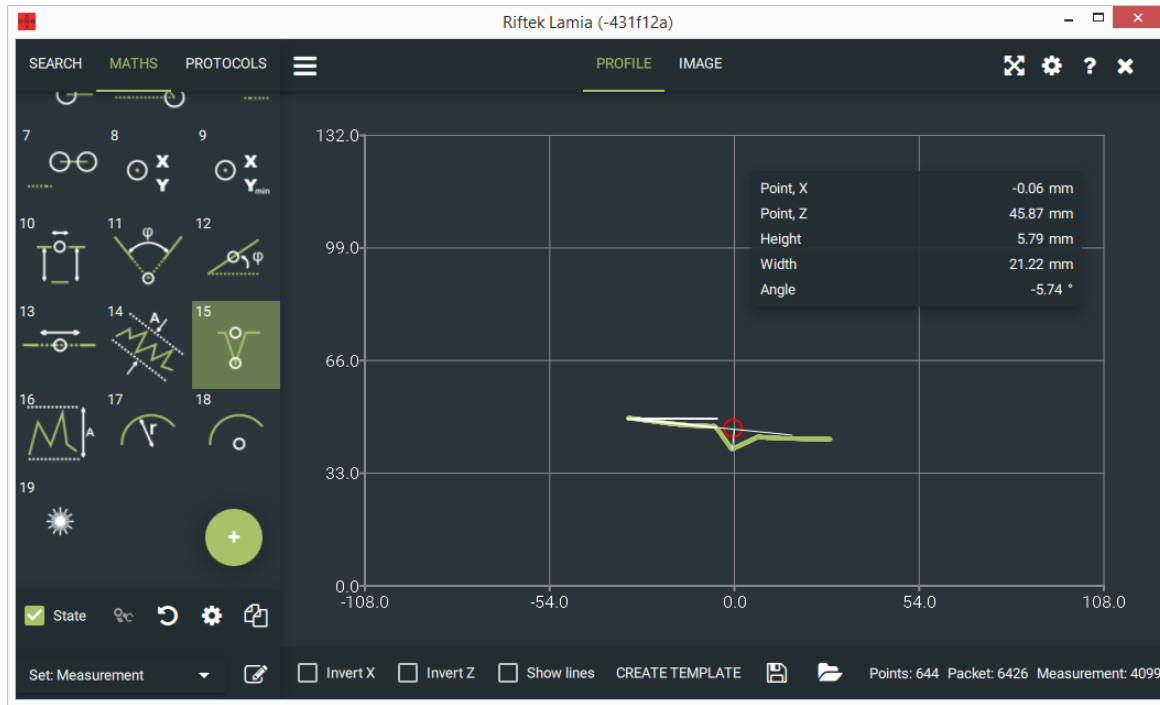

Constraints	Measurements	Parameters
-	<ul style="list-style-type: none"> • Point (coordinates of the point set by Search position) • Height • Width • Angle (inclination angle of a flat area) 	<p>Minimum plane length – The minimum length of a flat area, from which the measurement of a hill will start.</p> <p>Minimum hill height.</p> <p>Inverse search – Invert the Y-coordinate in order to measure the hollows.</p> <p>Search position:</p> <ul style="list-style-type: none"> • Projection • Center of mass • Top • Butt center

15.5.5.1.16. Template 16 "Hill"

Template 16 detects the longest line on the profile and measures its angle of inclination. This template also detects the hill on this line, and measures its height and the Z coordinate at X = 0. This template calculates the Z coordinate of the profile point or the Z coordinate of the approximated line point, depending on what value of the Z coordinate is the least.

49

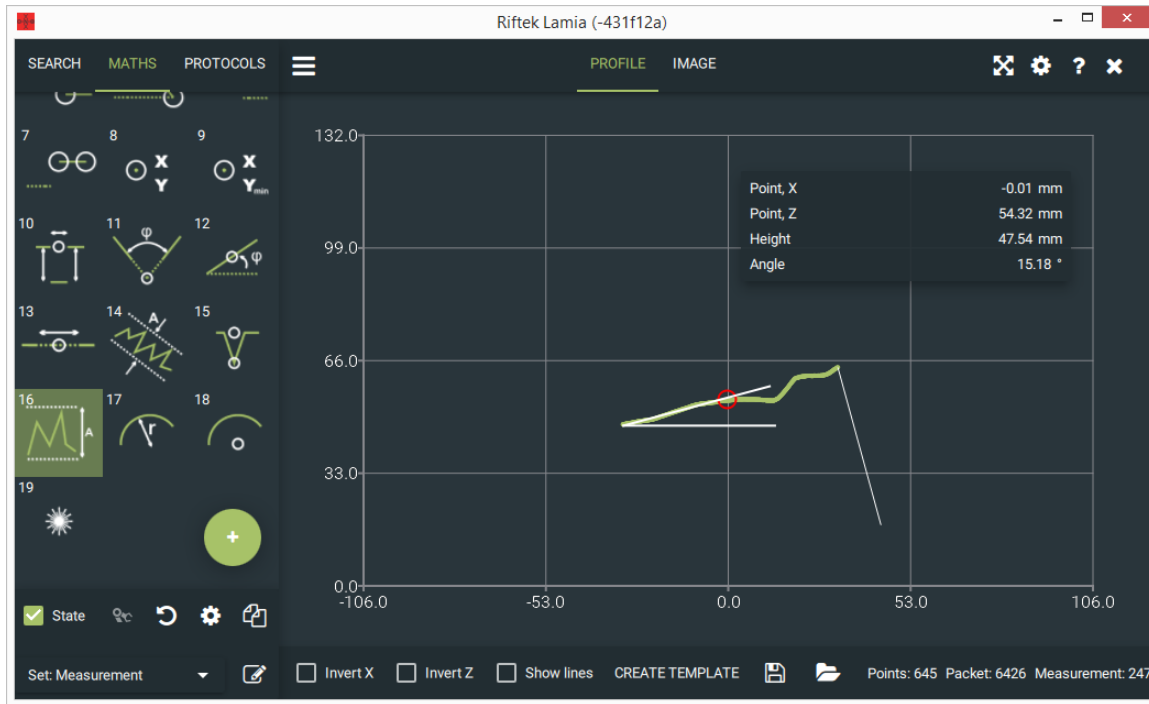

Constraints	Measurements	Parameters
-	<ul style="list-style-type: none"> • Z-coordinate of the profile point (or of the approximated line point) at X = 0. • Hill height relative to the longest line. • Inclination angle of the longest line. 	-

15.5.5.1.17. Templates 17 and 18 "Radius and circle center"

Templates 17 and 18 are intended to measure the radius and the coordinates of circle center.

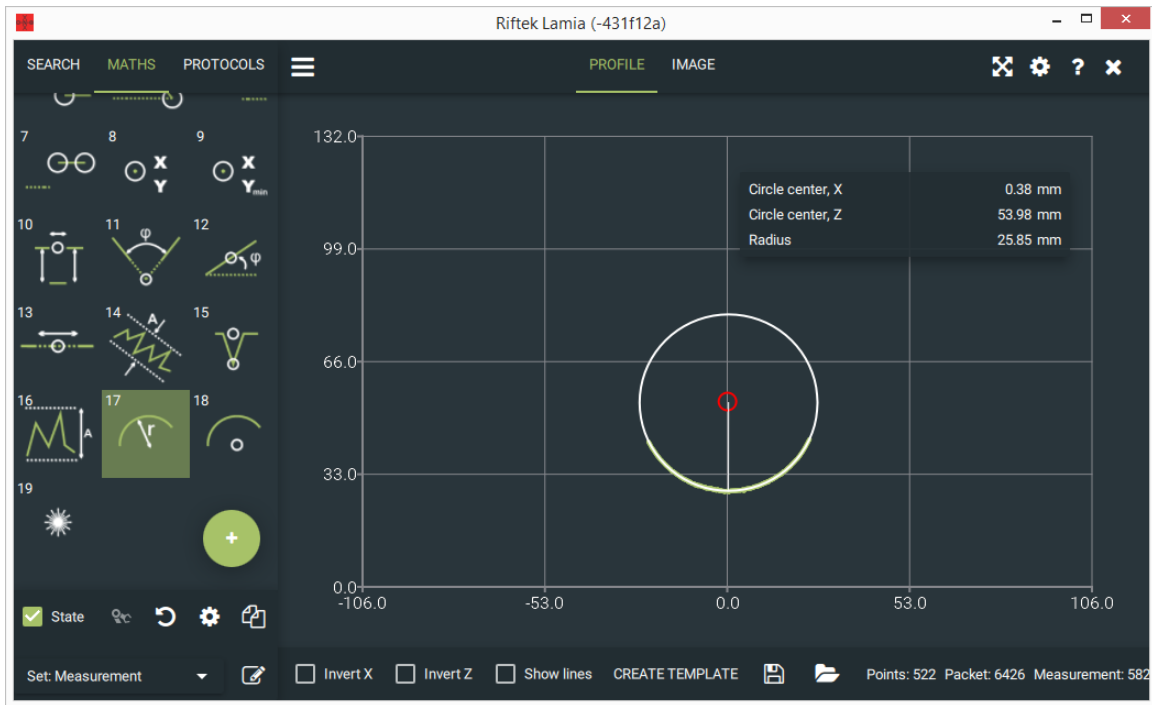

Constraints	Measurements	Parameters
-	<ul style="list-style-type: none"> • Circle center • Radius 	<p>Circle criterion (see par. 15.5.2) – the maximum value of the circle quality, with which a profile will be defined as a circle. The circle quality = the standard deviation of the profile points from the circle / circle radius. The range of values: 0..1 (the higher the value, the "worse" the circle). The "0" value is supposed to be set for detecting a perfect circle.</p>

 For template 18, only coordinates of the circle center will be sent to the robot.

15.5.5.2. "Welding" set

15.5.5.2.1. Template 1 "Fillet weld"

Template 1 is intended to be used for fillet welds. The algorithm looks for two profile lines and calculates coordinates of their point of intersection. This point of intersection can be used as the tracking point.

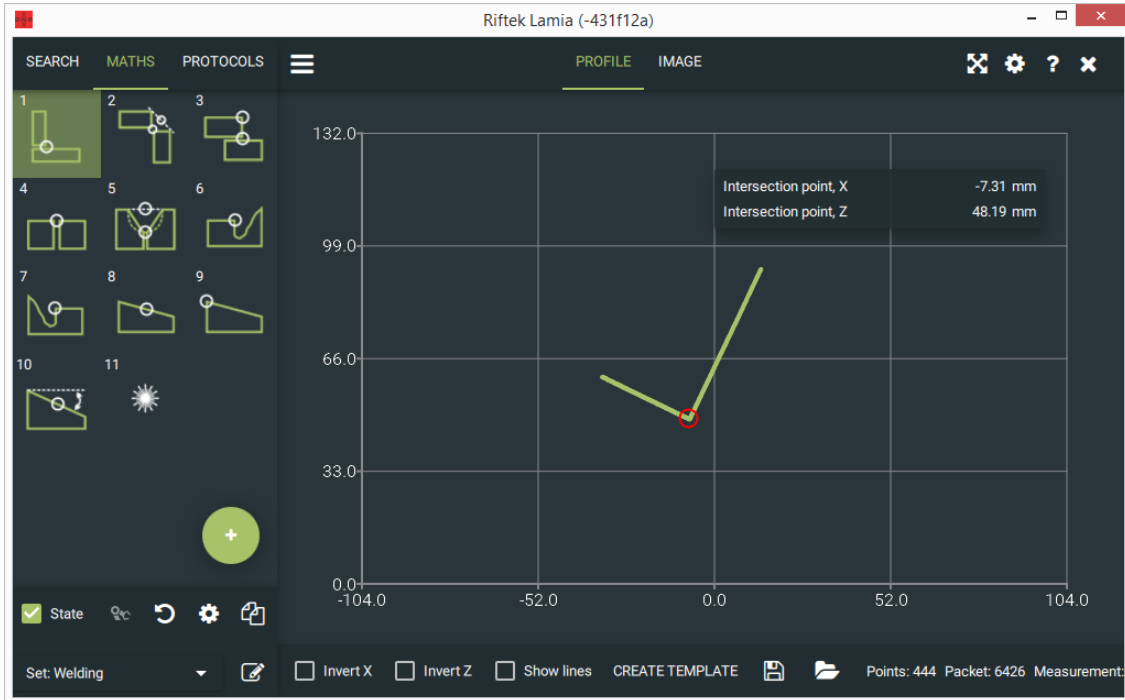

51

Constraints	Measurements	Parameters
<p>Endpoint distance with check</p> <ul style="list-style-type: none"> Distance between lines 0 and 1; the minimum distance is undefined, the maximum distance is 20 mm. <p>Rotation angle</p> <ul style="list-style-type: none"> Angle of rotation from line 0 to line 1 (30°...150°); the direction of rotation is undefined. 	<p>Lines intersection</p> <ul style="list-style-type: none"> Intersection point of lines 0 and 1. 	-

15.5.5.2.2. Template 2 "Corner weld"

Template 2 is intended to be used for corner welds. The algorithm allows the user to select the tracking point:

- Corner point, or
- Midpoint

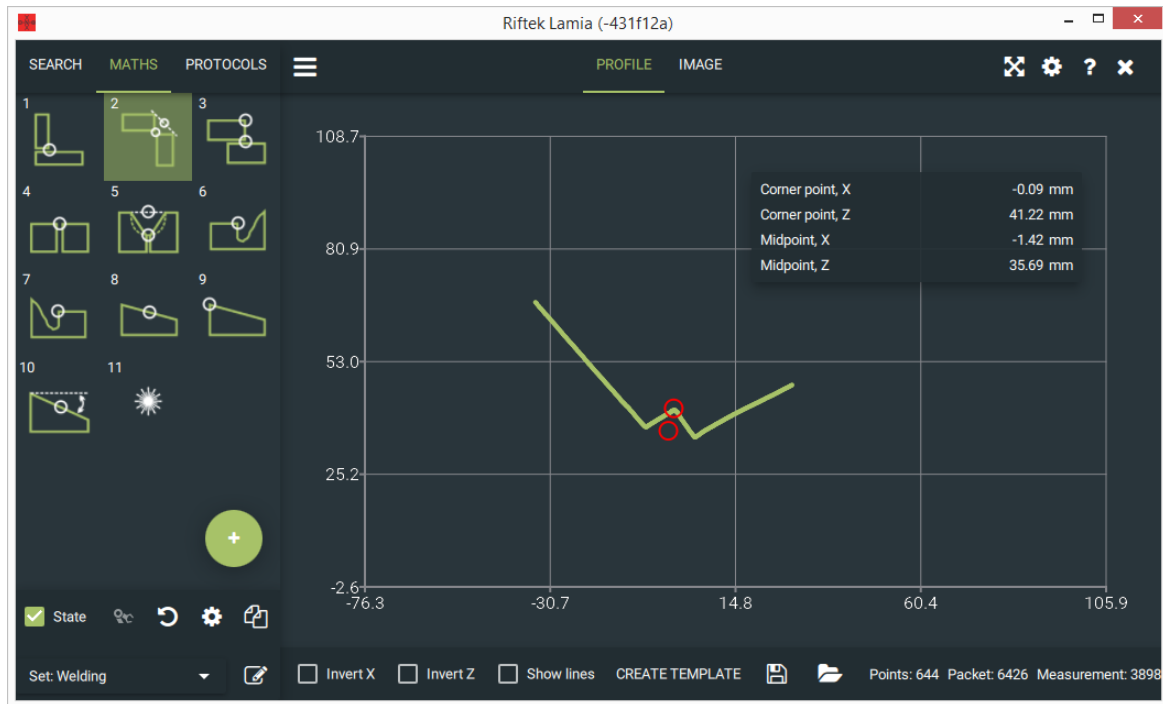

Constraints	Measurements	Parameters
<p>Endpoint distance with check</p> <ul style="list-style-type: none"> • Distance between lines 0 and 1; the minimum distance is undefined, the maximum distance is 5 mm. • Distance between lines 1 and 2; the minimum distance is undefined, the maximum distance is 5 mm. • Distance between lines 2 and 3; the minimum distance is undefined, the maximum distance is 5 mm. <p>Rotation angle</p> <ul style="list-style-type: none"> • Angle of rotation from line 0 to line 1 (60°...120°); the direction of rotation - left. • Angle of rotation from line 1 to line 2 (60°...120°); the direction of rotation - right. • Angle of rotation from line 2 to line 3 (60°...120°); the direction of rotation - left. 	<p>Lines intersection</p> <ul style="list-style-type: none"> • Corner point (intersection point of lines 1 and 2). <p>Point between 2 points</p> <ul style="list-style-type: none"> • Midpoint (between the endpoint of line 0 and the starting point of line 3). 	-

15.5.5.2.3. Template 3 "Lap weld"

Template 3 is intended to be used for lap welds. The algorithm looks for three profile lines and calculates the coordinates of their points of intersection, which can be taken as the tracking points.

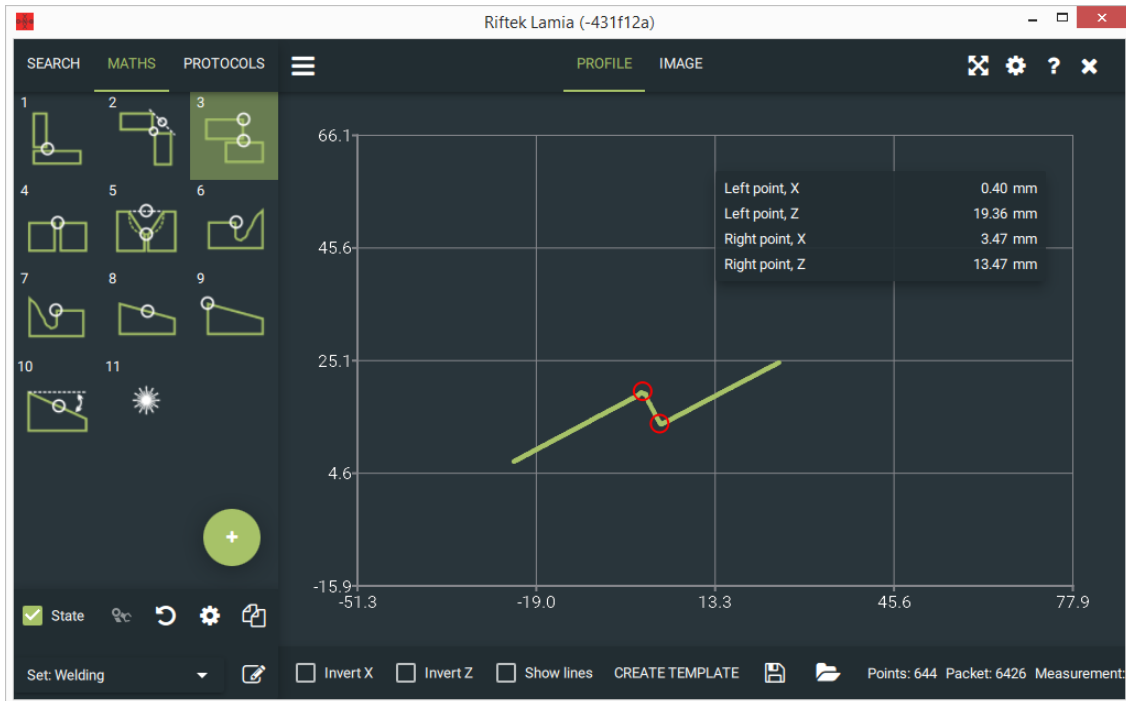

Constraints	Measurements	Parameters
<p>Endpoint distance with check</p> <ul style="list-style-type: none"> Distance between lines 0 and 1; the minimum distance is undefined, the maximum distance is 10 mm. Distance between lines 1 and 2; the minimum distance is undefined, the maximum distance is 10 mm. <p>Rotation angle</p> <ul style="list-style-type: none"> Angle of rotation from line 0 to line 1 (60°...120°); the direction of rotation is undefined. Angle of rotation from line 1 to line 2 (60°...120°); the direction of rotation is undefined. 	<p>Lines intersection</p> <ul style="list-style-type: none"> Left point (intersection point of lines 0 and 1). Right point (intersection point of lines 1 and 2). 	<p>-</p>

15.5.5.2.4. Template 4 "Square-groove butt weld"

Template 4 is intended to be used for square-groove butt welds. The algorithm looks for two profile lines and calculates the coordinates of a middle point between them, which can be taken as the tracking point. The algorithm also calculates the gap width.



Constraints	Measurements	Parameters
<p>Line length</p> <ul style="list-style-type: none"> Line 0; the minimum length is 20 mm, the maximum length is undefined. Line 1; the minimum length is 20 mm, the maximum length is undefined. <p>Endpoint distance with check</p> <ul style="list-style-type: none"> Distance between lines 0 and 1; the minimum distance is 2 mm, the maximum distance is undefined. <p>Rotation angle</p> <ul style="list-style-type: none"> Angle of rotation from line 0 to line 1; the minimum value is undefined, the maximum value is 10°; the direction of rotation is undefined. 	<p>Point between 2 points</p> <ul style="list-style-type: none"> Midpoint (between the end point of line 0 and the starting point of line 1). <p>Endpoint shift in direction</p> <ul style="list-style-type: none"> Width (distance between the end point of line 0 and the starting point of line 1). 	-

15.5.5.2.5. Template 5 "V-groove weld"

Template 5 can be used for V-grooves as well as for U-grooves, J-grooves and bevel grooves.

To select the tracking point, it is necessary to set the **Search position** in the **SEARCH** tab (see section [14.6.2](#)).

The algorithm also calculates the height and width of the groove and the inclination angle of a flat area.

55

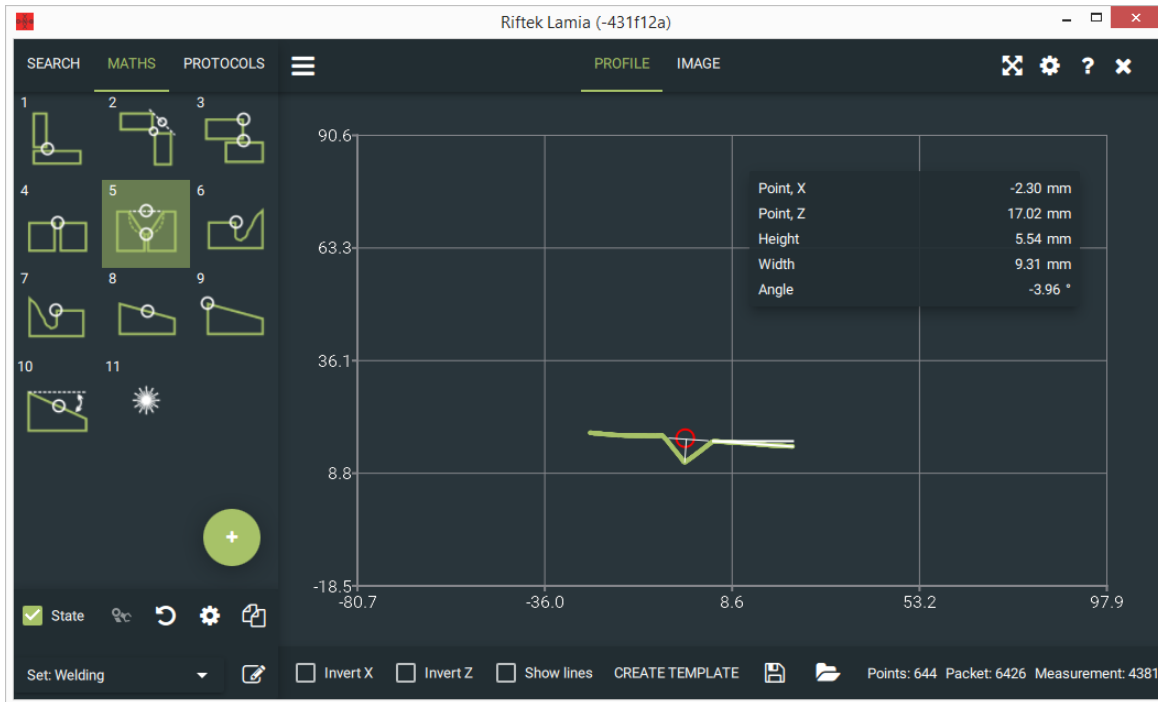

Constraints	Measurements	Parameters
-	<ul style="list-style-type: none"> Point (coordinates of the point set by Search position) Height Width Angle (inclination angle of a flat area) 	<p>Minimum plane length – The minimum length of a flat area, from which the measurement of a hill will start.</p> <p>Minimum hill height.</p> <p>Search position:</p> <ul style="list-style-type: none"> Projection Center of mass Top Butt center

15.5.5.2.6. Template 6 "Left edge"

Template 6 is intended to be used in a case when the geometry of one side of the groove does not allow to receive a correct information for tracking and the other side gives clear information.

The algorithm looks for the leftmost line of the all profile lines and calculates the coordinates of its right point and the angle of inclination. The right point can be taken as the tracking point.

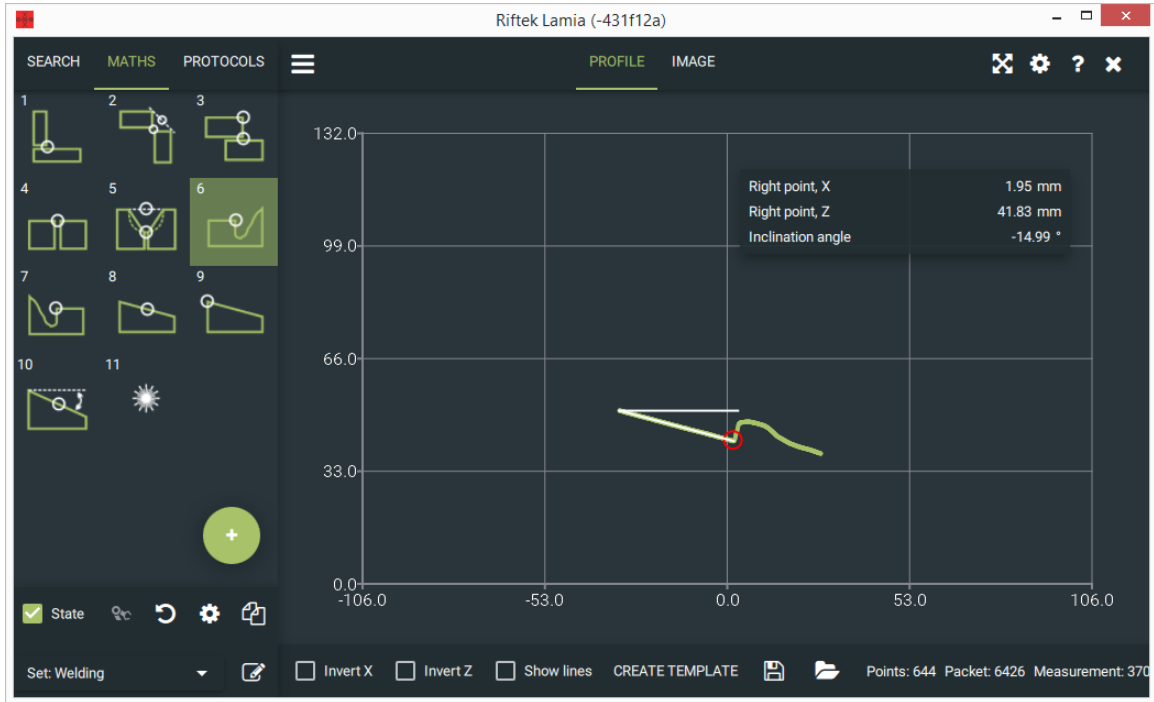

Constraints	Measurements	Parameters
-	Far line in direction <ul style="list-style-type: none"> • Right point (coordinates of the right point of the leftmost line). • Inclination angle of the leftmost line. 	-

15.5.5.2.7. Template 7 "Right edge"

Template 7 is intended to be used in a case when the geometry of one side of the groove does not allow to receive a correct information for tracking and the other side gives clear information.

The algorithm looks for the rightmost line of the all profile lines and calculates the coordinates of its left point and the angle of inclination. The left point can be taken as the tracking point.

57



Constraints	Measurements	Parameters
-	Far line in direction <ul style="list-style-type: none"> • Left point (coordinates of the left point of the rightmost line). • Inclination angle of the rightmost line. 	-

15.5.5.2.8. Template 8 "Spot weld"

Template 8 is intended to be used for spot welds.

The algorithm allows the user to set the X-coordinate of the tracking point in accordance with which the Z-coordinate will be calculated. If necessary, the user can set the tolerance for this X-coordinate (**Search range**). Both parameters are customized in the **SEARCH** tab (see section [14.6.2](#)).



Constraints	Measurements	Parameters
-	<ul style="list-style-type: none"> Z-coordinate 	<ul style="list-style-type: none"> X-coordinate Search range

15.5.5.2.9. Template 9 "Nearest point"

Template 9 is intended to be used in a case when the tracking point is the nearest point of the profile.

The algorithm calculates the X-coordinate of the tracking point at the minimum Z-coordinate.



Constraints	Measurements	Parameters
-	<ul style="list-style-type: none"> • X-coordinate of the profile point 	-

15.5.5.2.10. Template 10 "Slope"

Template 10 is intended to be used for finding the edges of sheet metal with the thickness of several millimeters. The algorithm looks for one profile line and calculates its angle of inclination and coordinates of a middle point.



60

Constraints	Measurements	Parameters
<p>Line length</p> <ul style="list-style-type: none"> Line length; the minimum length is 5 mm, the maximum length is undefined. 	<p>Inclination angle</p> <ul style="list-style-type: none"> Inclination angle of the line. <p>Line point</p> <ul style="list-style-type: none"> Midpoint (a middle point of the line). 	-

15.5.6. Operations with templates

15.5.6.1. Adding a template

To add a template into the area of templates, click . The following window appears:

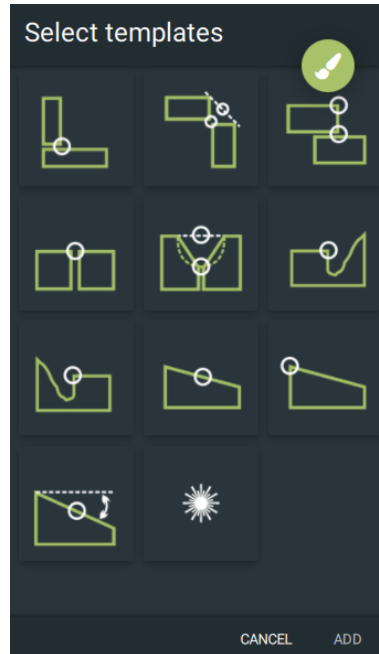



Select a template (or several templates) and click **ADD**.
To close the window, click **CANCEL**.

15.5.6.2. Copying a template

To create a copy, select a template and click . The copied template will be added to the end of the list.

15.5.6.3. Removing a template

Enable the **Edit** mode by clicking . The pictogram  will change its color to green and you will see the "remove" pictogram  on each template:

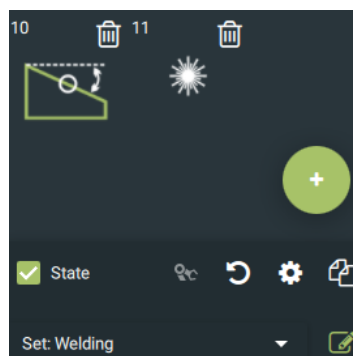

To remove a template, click .

NOTE 1: The program doesn't prompt to confirm the action, and you cannot restore a template that was removed.

NOTE 2: Always disable the **Edit** mode after editing.

15.5.6.4. Changing the order

Enable the **Edit** mode as described in the previous section.

To change the order, hold the left mouse key pressed and drag the template to the required position.

NOTE: Always disable the **Edit** mode after editing.

15.5.6.5. Restoring a default set of templates

To restore a default set of templates, click . You will be prompted to confirm the action:

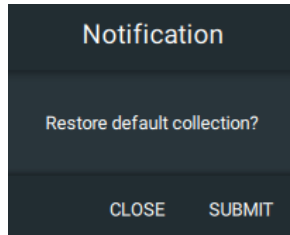

Click **SUBMIT** to confirm the action, otherwise – click **CLOSE**.

After confirming, the current set of templates will be replaced with the default one.

15.5.7. Template Wizard

The Template Wizard allows the user to create mathematical templates from the profile lines. To call the Template Wizard, click the **CREATE TEMPLATE** button:



The following window appears:

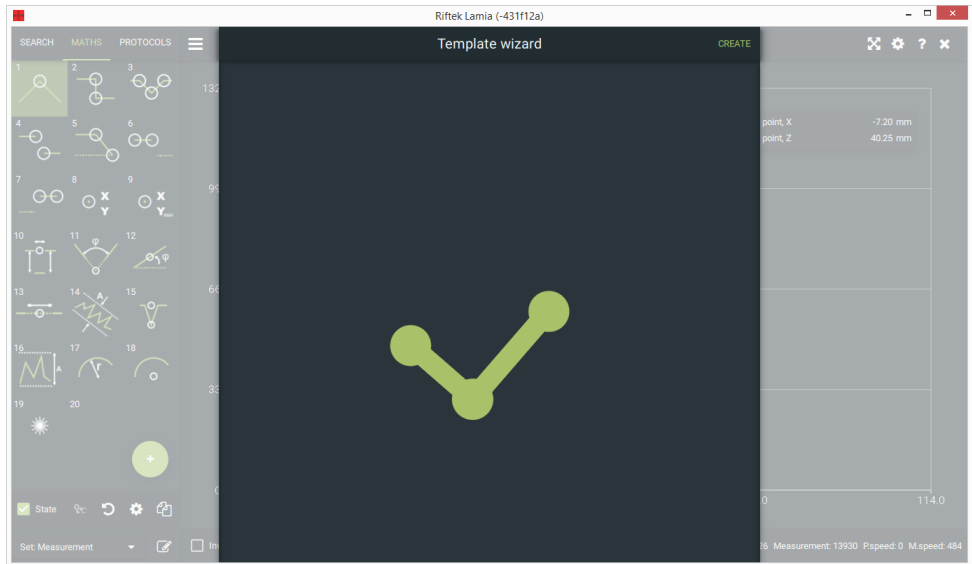

When you click on the extreme point of the line, the following actions are available:

- Add measurement.
- Line from here.
- Move.
- Delete line.

When you click on any other point, the following actions are available:

- Add constraint.
- Add measurement.
- Delete line.
- Move.

The user can create new lines, as well as delete and move existing ones. To draw a new line from the extreme point, select the **Line from here** option. To move a line, use the **Move** option, to delete - **Delete line**. To create a new line (not from the extreme point of the existing one), click in the place from which you want to draw a line, and then in the place where its end point will be.

To set the constraint type for a new template, select the required item in the **Add constraint** menu. The constraint types are described in par. [15.5.3](#). The program will display the added constraint type. Then you need to configure its parameters:

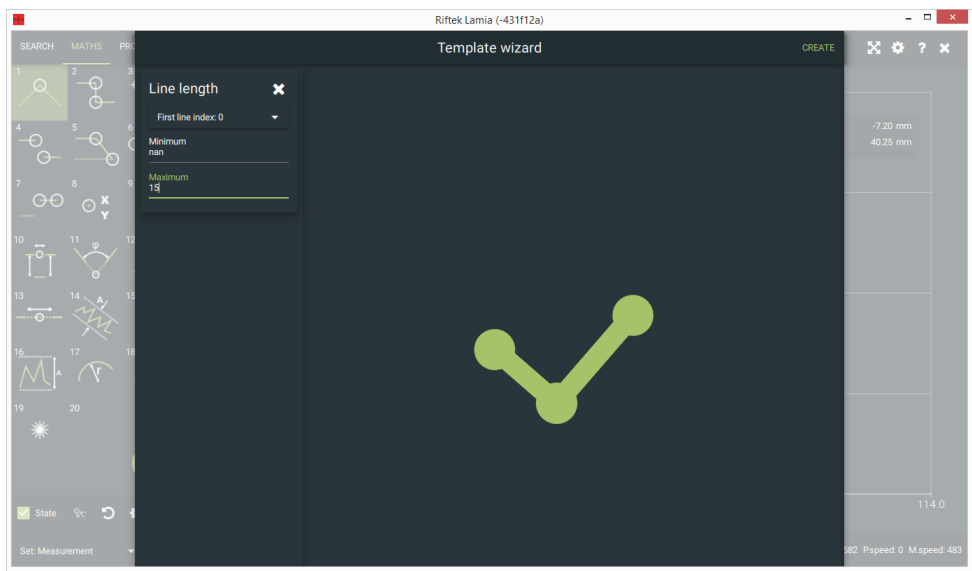

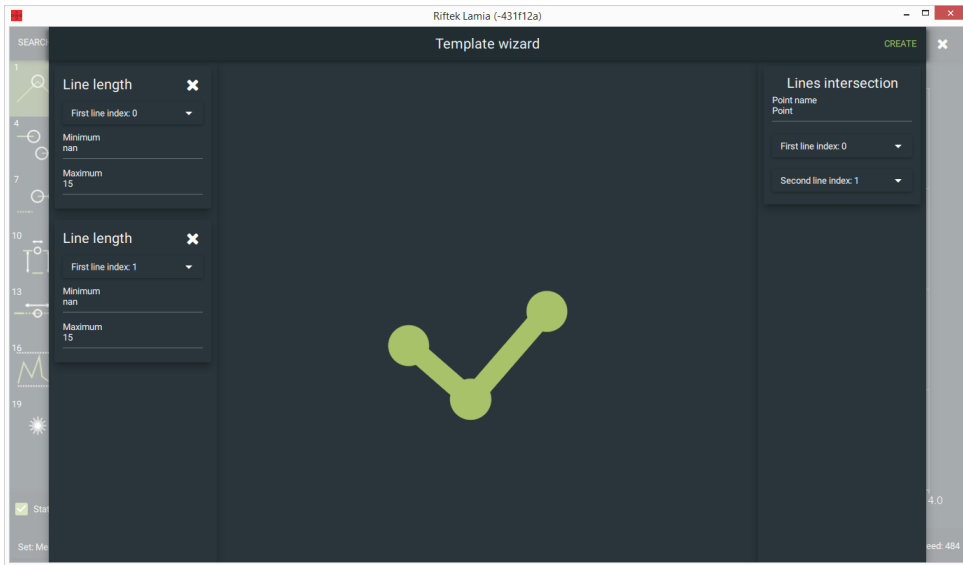

To add the measurement type for a new template, select the required item in the **Add measurement** menu. The measurement types are described in par. [15.5.4](#). The program will display the added measurement type. Then you need to configure its parameters:



When all template parameters are set, click the **CREATE** button in the upper right corner of the window. A new template will be added to the template selection area.

In addition, there is another way to call the Template Wizard:

- Open the **Select templates** window by clicking on .
- In the **Select templates** window, click on .

15.6. "PROTOCOLS" tab. Working with welding robots

15.6.1. General information

The Riftek Lamia software offers the following protocols: Riftek P1, R691 USI, Riftek P2, Riftek P3.

NOTE: The Riftek P1 and R691 USI protocols cannot be used with the "Welding" set.

In the PROTOCOLS tab, parameters and buttons are displayed in accordance with the selected protocol. A detailed description of the protocols is given in the sections below.

 Before using the Riftek P2 and Riftek P3 protocols, it is necessary to calibrate the scanner. The calibration procedure is described in par. [15.6.8](#).

15.6.2. Functional diagram

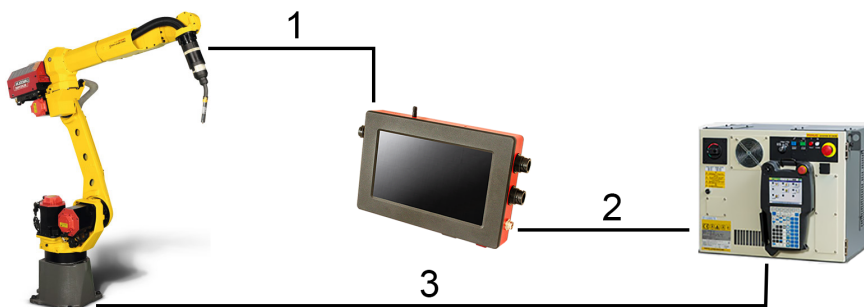

#	Description
1	The scanner fixed to the robot transmits data to the controller (or to the PC with the Riftek Lamia software installed).
2	Riftek Lamia processes the data in accordance with the selected math algorithm and transmits the results to the robot controller over the selected protocol.
3	The robot controller makes decisions based on the received information. For example, corrects the position of the welding torch during the welding process.

15.6.3. Connection procedure



Important!

Before connecting to the robot, it is necessary to activate the license for the Riftek Lamia software. The license activation procedure is described in par. [15.3.4](#).

To connect to the robot, start Riftek Lamia and perform the following steps:

Step	Description
1	Click the SEARCH button and connect to the scanner.
2	Go to the PROTOCOLS tab and click LOCK SENSOR. NOTE: This step is performed only once when connecting a new scanner. If the scanner has previously been connected to the robot, you do not need to click the LOCK SENSOR button again.
3	Select a protocol and configure parameters.
4	Enable the "State" option.

15.6.4. Riftek P1 protocol

15.6.4.1. General information

The **Riftek P1** protocol is based on the client-server model (**Riftek Lamia** is a client, a robot is a server) and uses port 502 by default.

All values are hexadecimal, byte order – from left to right.

After turning on/off the Modbus function, the scanner must be rebooted. The TCP connection temporary deactivates the Modbus function; when activating the Modbus function (the scanner finds the IP address and successfully connects to port 502), other scanner functions will be deactivated (including TCP).

The **PROTOCOLS** tab with the **Riftek P1** protocol selected:

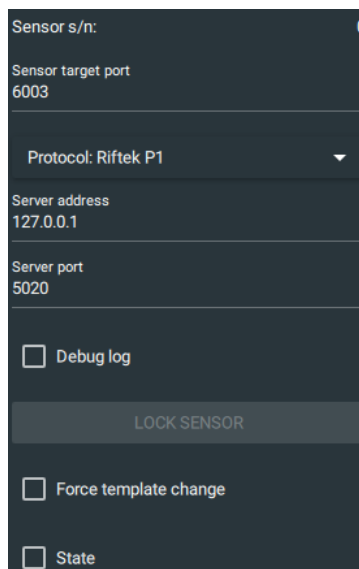

Parameters and buttons:

Parameter	Description
Sensor s/n	Serial number of the scanner.
Sensor target port	UDP port to which the scanner sends profiles (6003 by default).
Protocol	Protocol selection.
Server address	IP address of the robot.
Server port	Robot port (502 by default).
Debug log	Save the debug log: time and type of request from the robot, bytes of commands, the response time of the program, response bytes, error text.
LOCK SENSOR	Lock the scanner to the protocol settings.
Force template change	Forced template change for every received packet.
State	Enable the selected protocol.



When the **State** option is enabled, you cannot change parameters in the **PROTOCOLS** tab.

15.6.4.2. Packets and parameters

Send packet 1 with delay (ms).

Displacement	Length	Field	Description
0	2	TrID1	Transaction ID (set by the client, copied by the server in response)
2	2	ProtoID	Protocol type (0 = Modbus)
4	2	Len1	Quantity of following bytes
6	1	UnitID	Slave address
7	1	Fn1	Function number = 4
8	2	Adr1	Starting register address
10	2	Cnt1	Quantity of registers

Wait for the response, check the high-order bit of the 36th byte: 1 - perform calculations, 0 - send zeroes in response. Send packet 2 (with results).

Displacement	Length	Field	Description
0	2	TrID1	Transaction ID (set by the client, copied by the server in response)
2	2	ProtoID	Protocol type (0 = Modbus)
4	2	Len1	Quantity of following bytes
6	1	UnitID	Slave address
7	1	Fn2	Function number = 16
8	2	Adr2	Starting register address
10	2	Cnt2	Quantity of registers
12	1	BCnt2	Byte counter
13	2	REG[1]	1st register
15	2	REG[2]	2nd register
...
13+2*(Cnt2-1)	2	REG[Cnt2]	The last register

15.6.4.3. Types of calculations (commands) and assignment of registers

Data transmission from the scanner to the robot:

13-16 bytes - the 1st control point, coordinate X

17-20 bytes - the 1st control point, coordinate Z

21-24 bytes - the 2nd control point, coordinate X

25-28 bytes - the 2nd control point, coordinate Z
 29-32 bytes - the 3rd control point, coordinate X (not used)
 33-36 bytes - the 3rd control point, coordinate Z (not used)
 Unit of measurement of all values – micrometer. X – signed, Z – unsigned.
 The value "99" is reserved as erroneous.

Data transmission from the robot to the scanner:

the 27th byte **Polynom Degree** - the polynom degree (experimentally proved, when degree is less than 7, the returned result can be incorrect, by default "10" - see the Notes column in the Table below)

28-29 bytes **CenterX** - the center of search area of control points along X-axis*

30-31 bytes **Amplitude** - the half-width of search area of control points along X-axis*

32-33 bytes **MaxBreak** - the limit value of distance between the points. If distance between the points is greater than this value, then this position is taken as the gap*

the 34th byte **LightDir** - the direction of laser radiation (0 = L, 1 = R)

the 35th byte **CMD** - the type of mathematical calculation (see Table)

The most significant bit in the 36th byte (**Strobe**) is the data transmission request (strobe bit).

* Values CenterX, Amplitude and MaxBreak are specified in 0.1mm. CenterX is signed, and the rest are unsigned.

The Measurement set (see par. [15.5.5.1](#)):

Calculation type	Command number (Byte 35)	Notes
Template 1	0	When the Polynom Degree transmission = 0, an adaptive algorithm of calculations will be used (priority of tracking in the window with polynom degree = 7). In other calculations, PolynomDegree transmission = 0 means that a default value is used.
Template 2	1	
Template 3	2	
Template 4	3	
Template 5	4	
Template 6	5	
Template 7	6	
Template 8	7	The X value is specified by CenterX
Turn off the laser	80h	
Turn on the laser	81h	

15.6.5. R691 USI protocol

15.6.5.1. General information

The **R691 USI** protocol is based on the client-server model (**Riftek Lamia** is a server, a robot is a client), works over TCP, and uses port 5020 by default.

The **PROTOCOLS** tab with the **R691 USI** protocol selected:

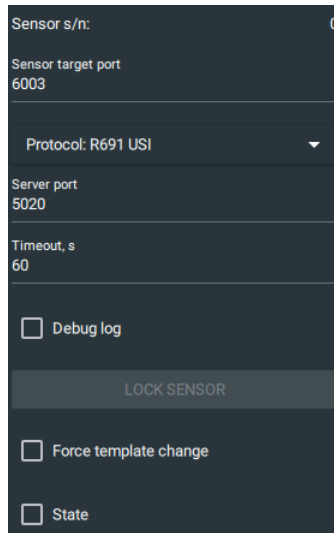

Parameters and buttons:

Parameter	Description
Sensor s/n	Serial number of the scanner.
Sensor target port	UDP port to which the scanner sends profiles (6003 by default).
Protocol	Protocol selection.
Server port	Host PC port (5020 by default).
Timeout, s	Time after which the protocol will be disabled if there are no commands or requests from the robot.
Debug log	Save the debug log: time and type of request from the robot, bytes of commands, the response time of the program, response bytes, error text.
LOCK SENSOR	Lock the scanner to the protocol settings.
Force template change	Forced template change for every received packet.
State	Enable the selected protocol.

 When the **State** option is enabled, you cannot change parameters in the **PROTOCOLS** tab.

15.6.5.2. Client (robot) requests

The robot sends requests to the scanner by packets of at least 3 bytes in length. The first byte indicates if the robot sends a command (02h) or requests data (01h). The second byte is the number of commands or data for this packet (usually 1). The third byte indicates the command or the data request.

#	Request	Read / Write (byte 0)	Number of variables	Command or Data	Value
1	Sensor On	02h	01h	13h	01h
2	Sensor Off	02h	01h	06h	00h
3	Start track (Laser on and measure)	02h	01h	06h	01h
4	End track (Laser off)	02h	01h	06h	00h
5	Set joint ID	02h	01h	10h	xx (joint number in hex)
6	Request joint data	01h	06h	08h 09h 0Ah 0Bh 0Ch 0Dh *	Important! It is necessary to transfer all six values.
7	Request status	01h	01h	06h	—
8	Request joint ID	01h	01h	10h	—

The robot waits for a response from the scanner for 80 ms.

After 80 ms without a response, the robot sends the same request again.

After 300 ms without a response, a Timeout Alarm will be posted and the connection will be broken.

*** Request 6 (Request joint data) requests six values in the following order:**

- | | |
|-------------|------------------|
| 1. Offset X | 4. GAP |
| 2. Offset Y | 5. MISMATCH |
| 3. Offset Z | 6. AREA (Region) |

Measurements are sent to the robot in accordance with the selected template.

The Measurement set:

Template #	Measurements
1	Offset Y: the X coordinate of the intersection point of two lines Offset Z: the Z coordinate of the intersection point of two lines
2	Offset Y: the X coordinate of the highest point along the Z axis Offset Z: the Z coordinate of the highest point along the Z axis
3	Offset Y: the X coordinate of the selected point Offset Z: the Z coordinate of the selected point Note. If there are more than one point selected, only coordinates of the first point will be sent to the robot.
4	Offset Y: the X coordinate of the highest point along the Z axis Offset Z: the Z coordinate of the highest point along the Z axis
5	Offset Y: the X coordinate of the selected point Offset Z: the Z coordinate of the selected point Note. If there are more than one point selected, only coordinates of the first point will be sent to the robot.
6	Offset Y: the X coordinate of the most right point Offset Z: the Z coordinate of the most right point
7	Offset Y: the X coordinate of the most left point Offset Z: the Z coordinate of the most left point
8	Offset Y: the X coordinate set by the user Offset Z: the Z coordinate in accordance with the set X coordinate
9	Offset Y: the X coordinate of the lowest point along the Z axis Offset Z: the Z coordinate of the lowest point along the Z axis
10	Offset Y: the X coordinate of the center point Offset Z: the Z coordinate of the center point
11	Offset Y: the X coordinate of the intersection point of two lines Offset Z: the Z coordinate of the intersection point of two lines
12	Offset Y: the X coordinate of the center point Offset Z: the Z coordinate of the center point
13	Offset Y: the X coordinate of the center point Offset Z: the Z coordinate of the center point Gap: gap width
14	-
15	Offset Y: the X coordinate of the point set by "Search position" Offset Z: the Z coordinate of the point set by "Search position"
16	Offset Y: the X coordinate = 0 Offset Z: the Z coordinate at X = 0 Gap: inclination angle Mismatch: hill height
17	Offset Y: the X coordinate of the circle center (sent as an integer, not multiplied by 100) Offset Z: the Z coordinate of the circle center (sent as an integer, not multiplied by 100) Gap: radius (sent as an integer, not multiplied by 100)

Template #	Measurements
18	Offset Y: the X coordinate of the circle center Offset Z: the Z coordinate of the circle center

The Welding set:

Template #	Measurements
1	Offset Y: the X coordinate of the intersection point of two lines Offset Z: the Z coordinate of the intersection point of two lines
2, 3	Offset Y: the X coordinate of the selected point Offset Z: the Z coordinate of the selected point Note. If there are more than one point selected, only coordinates of the first point will be sent to the robot.
4	Offset Y: the X coordinate of the center point Offset Z: the Z coordinate of the center point Gap: gap width
5	Offset Y: the X coordinate of the point set by "Search position" Offset Z: the Z coordinate of the point set by "Search position"
6	Offset Y: the X coordinate of the most right point Offset Z: the Z coordinate of the most right point
7	Offset Y: the X coordinate of the most left point Offset Z: the Z coordinate of the most left point
8	Offset Y: the X coordinate set by the user Offset Z: the Z coordinate in accordance with the set X coordinate
9	Offset Y: the X coordinate of the lowest point along the Z axis Offset Z: the Z coordinate of the lowest point along the Z axis
10	Offset Y: the X coordinate of the center point Offset Z: the Z coordinate of the center point

15.6.5.3. Scanner answers

For commands 1-5 (see [Client \(robot\) requests](#)), the scanner answers with only one byte (82h).

For requests 6-8, the scanner answers as follows: the first byte is 82h, the second byte is an error code, then two bytes for each value (high byte, low byte).

15.6.5.4. Error codes

Error code	Description
0	No error.
1	External alarm (not used).
2	Invalid checksum (not used).
3	Correction (not used).
4	Timeout (not used).
5	Camera alarm (not used).
6	Bad end (not used).
7	Correct message (not used).
8	Unknown parameter (not used).
9	Setup error (not used).
10	Temperature alarm (not used).
11	Value out of range (not used).
12	Data not available (joint not found).

15.6.5.5. Scanner status

For request 7 (status request), the robot expects a 16-bit status word with the following meaning:

Bit number	Value	Decimal bit value
0	No Alarm	1
1	No External Alarm	2
2	No Temperature Alarm	4
3	Not too cold	8
4	Not too hot	16
5	No shut down	32
6	Laser Off	64
7	Laser Down	128
8	Laser Power control disabled	256
9	Flash Checksum invalid	512
10	Calibration Data missing	1024
11	Laser Ready(0x800)	2048
12	Laser On(0x1000)	4096
13	Reserved	8192
14	Reserved	16384
15	Reserved	32768

NOTE: Bits 6, 11, 12 must be set by the scanner and will be used by the robot. Data values are transmitted in the two's complement system.

15.6.5.6. Example

Robot request for status:

[01H] [01H] [06H]

Sensor answer:

[82H] Answer from sensor

[00H] No error

[08H] High byte of status1

[40H] Low byte of staus1

Decimal:

08H*256 2048

40H + 64

= 2112

64 = Bit 6 > Laser Off

2048 = Bit 11 > Laser Ready (0x800)

15.6.6. Riftek P2 protocol

15.6.6.1. General information

Modbus TCP protocol.

The **Riftek P2** protocol is based on the client-server model (a robot is a client, **Riftek Lamia** is a server), works over TCP, and uses port 502 by default.

The server does not consider the device address and responds to any Modbus TCP command.

Data is transmitted via reading/writing of holding registers. Command codes:

Command code	Description
0x03	Read holding registers.
0x10	Write holding registers.

The **PROTOCOLS** tab with the **Riftek P2** protocol selected:

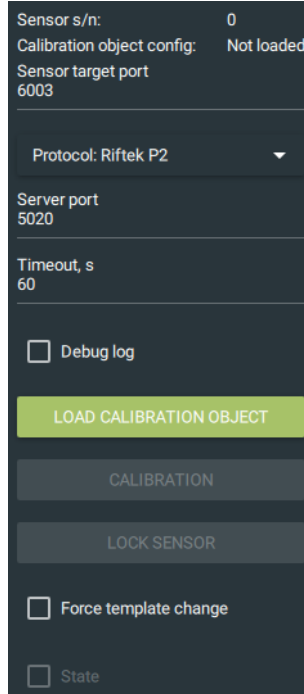

Parameters and buttons:

Parameter	Description
Sensor s/n	Serial number of the scanner.
Sensor target port	UDP port to which the scanner sends profiles (6003 by default).
Protocol	Protocol selection.
Server port	Host PC port (502 by default).
Timeout, s	Time after which the protocol will be disabled if there are no commands or requests from the robot.
Debug log	Save the debug log: time and type of request from the robot, bytes of commands, the response time of the program, response bytes, error text.
LOAD CALIBRATION OBJECT	Load the calibration object file (for example, calibration_object_CUSTOMER_1.json). If you don't have it, contact technical support at support@riftek.com .
CALIBRATION	Show the "Calibration" panel. NOTE: This button is active only when the "State" option is enabled.
LOCK SENSOR	Lock the scanner to the protocol settings.
Force template change	Forced template change for every received packet.
State	Enable the selected protocol.

- 1. It is necessary to calibrate the scanner before using this protocol. See par. [15.6.8](#).
- 2. When the **State** option is enabled, you cannot change parameters in the **PROTOCOLS** tab.

15.6.6.2. Holding registers

Read holding registers:

16 bit	15 bit	Scanner 3D Point X * 10 (absolute value).
	1 bit	Least significant bit.
16 bit	15 bit	Scanner 3D Point Y * 10 (absolute value).
	1 bit	Least significant bit.
16 bit	15 bit	Scanner 3D Point Z * 10 (absolute value).
	1 bit	Least significant bit.
16 bit	8 bit	The latest counter that was received from the robot (unsigned).
	8 bit	Reserved.
16 bit	15 bit	Robot P * 10 (absolute value).
	1 bit	Least significant bit.
16 bit	15 bit	Robot R * 10 (absolute value).
	1 bit	Least significant bit.
16 bit	15 bit	Scanner 2D Point X * 10 (absolute value).
	1 bit	Least significant bit.
16 bit	15 bit	Scanner 2D Point Y * 10 (absolute value).
	1 bit	Least significant bit.

Write holding registers:

16 bit	15 bit	Robot X * 10 (absolute value).
	1 bit	Least significant bit.
16 bit	15 bit	Robot Y * 10 (absolute value).
	1 bit	Least significant bit.
16 bit	15 bit	Robot Z * 10 (absolute value).
	1 bit	Least significant bit.
16 bit	8 bit	Robot W * 10 (absolute value).
	8 bit	Least significant bit.
16 bit	15 bit	Robot P * 10 (absolute value).
	1 bit	Least significant bit.
16 bit	15 bit	Robot R * 10 (absolute value).
	1 bit	Least significant bit.
16 bit	8 bit	Packet counter (unsigned).
	8 bit	Command (unsigned): 0 - no command, 1 - laser ON, 2 - laser OFF. If the command is the same as previous, nothing will happen.
16 bit	8 bit	Template set selection (unsigned): 0 - Measurement, 1 - Welding. If the template set number is the same, nothing will happen.
	8 bit	Template selection (unsigned). If the template number is the same, nothing will happen.

15.6.6.3. Operation logic

1) The robot writes at least six registers (will be taken only six, starting with zero) by six coordinates in the following format: 15 bit - value, 1 least significant bit - sign. The float value transmitted by the robot will be multiplied by 10 in order to contain 1 digit after the point.

2) The robot reads at least eight registers. Riftek Lamia returns eight registers, containing:

- 3D coordinates (XYZ) of a point found by a template (in the robot coordinate system);
- 3 angles that were returned by the robot the last time (by a command 0x10);
- coordinates (XZ) of a point found by a template (in the scanner coordinate system).

Each value is multiplied by 10 to be transmitted and occupies 1 register. The format: 15 bit - value, 1 least significant bit - sign.

For any commands different from mentioned here, Riftek Lamia will respond with the garbage values, or write data, which will not be taken into account in Riftek Lamia.

15.6.7. Riftek P3 protocol

15.6.7.1. General information

The Riftek P3 protocol is based on the EtherNet/IP protocol. It is an industrial protocol that allows bidirectional data transfer with PLCs. EtherNet/IP encapsulates the object-oriented Common Industrial Protocol (CIP).

To EtherNet/IP-enabled devices on the network, the Riftek Lamia information is seen as a collection of objects, which have attributes that can be queried.

The PLC sends a command to establish a connection with Riftek Lamia. The PLC then periodically queries the attributes of the assembly objects for its latest measurement results. In EtherNet/IP terminology, the PLC is a scanner and the Riftek Lamia software is an adapter.

The default EtherNet/IP ports are used. Port 44818 is used for TCP connections and UDP queries. Port 2222 is used for UDP I/O Messaging.

Riftek Lamia supports unconnected or connected explicit messaging (with TCP), as well as implicit (or I/O) messaging (with UDP). For information on explicit messaging assemblies and objects, see the "Explicit messaging" section below.

For information on implicit messaging assemblies and objects, see the "Implicit messaging" section.

The **PROTOCOLS** tab with the **Riftek P3** protocol selected:

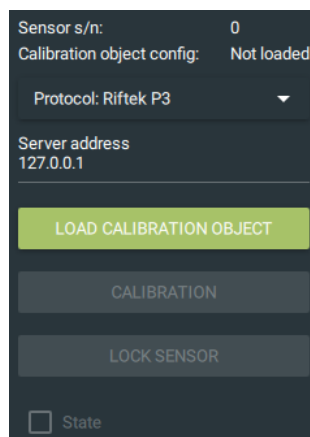

Parameters and buttons:

Parameter	Description
Sensor s/n	Serial number of the scanner.
Protocol	Protocol selection.
Server address	TCP/IP address of the robot controller.

Parameter	Description
LOAD CALIBRATION OBJECT	Load the calibration object file (for example, calibration_object_CUSTOMER_1.json). If you don't have it, contact technical support at support@riftek.com .
CALIBRATION	Show the "Calibration" panel. NOTE: This button is active only when the "State" option is enabled.
LOCK SENSOR	Lock the scanner to the protocol settings.
State	Enable the selected protocol.



1. It is necessary to calibrate the scanner before using this protocol. See par. [15.6.8](#).
2. When the **State** option is enabled, you cannot change parameters in the **PROTOCOLS** tab.

75

15.6.7.2. Explicit messaging

Riftek Lamia supports all required objects for explicit messaging, such as the Identity object, TCP/IP object, and Ethernet link object. In addition, an Assembly object is used for sending and receiving data.

The Assembly object contains Input and Output assemblies: the input assembly (16 bytes), the output assembly (16 bytes). The data attribute (0x03) of the assembly objects is a byte array. The data attribute can be accessed with the Get Attribute and Set Attribute commands.

15.6.7.2.1. Identity object (class 0x01)

Attribute	Name	Type	Value	Description	Access
1	Vendor ID	UINT	803	Vendor ID	Get
2	Device Type	UINT	12	Device Type	Get
3	Product Code	UINT	32	Product Code	Get
4	Revision	USINT USINT	0.0	Byte 0 - Major Revision Byte 1 - Minor Revision	Get
6	Serial number	UDINT	32-bit value	License number	Get
7	Product Name	SHORT STRING	"RIFTEK_LAMIA"	Lamia Product Name	Get

15.6.7.2.2. TCP/IP object (class 0xF5)

Attribute	Name	Type	Value	Description	Access
1	Status	UDINT	0	TCP interface status	
2	Configuration Capability	UINT	0		
3	Configuration Control	UINT	0	Product Code	
4	Physical Link Object	Structure		Path size (UINT) Path (Padded EPATH)	
5	Interface Configuration	Structure		IP Address (UDINT) Network Mask (UDINT), Gateway Address (UDINT) Name Server (UDINT) Secondary Name (UDINT) Domain Name (UDINT)	

15.6.7.2.3. Ethernet link object (class 0xF6)

Attribute	Name	Type	Value	Description	Access
1	Interface Speed	UDINT	1000	Ethernet interface data rate (mbps)	Get
2	Interface Flags	UDINT		Bit 0: Link Status 0 - Inactive 1 - Active Bit 1: Duplex 0 - Half Duplex 1 - Full Duplex	Get
3	Physical Address	Array of 6 USINTs		MAC address (for example: 11 22 33 44 55 66)	Get

15.6.7.3. Implicit messaging

Implicit messaging uses UDP and is faster than explicit messaging, and is ideal for time-critical applications. However, implicit messaging is layered on top of UDP. UDP is connectionless and data delivery is not guaranteed. For this reason, implicit messaging is only suitable for applications where occasional data loss is acceptable.

15.6.7.3.1. Assembly object (class 0x04)

For implicit messaging, the Lamia Ethernet/IP object model includes the following assemblies: Input Assembly (instance 0x65), Output Assembly (instance 0x66), Configuration Assembly (instance 0x64).

All assembly object instances are static. Data in a data byte array in an assembly object are stored in the big endian format.

15.6.7.3.2. Input assembly (instance 0x65)

Input assembly:

Information	Value
Class	0x04
Instance	0x65
Attribute Number	3
Length	16 bytes

Input assembly information:

Byte	Name	Description
0-1	3D X coordinate	0-14 bits: 3D X coordinate of scanner * 10 (module) 15 bit: Least significant sign bit
2-3	3D Y coordinate	0-14 bits: 3D Y coordinate of scanner * 10 (module) 15 bit: Least significant sign bit
4-5	3D Z coordinate	0-14 bits: 3D Z coordinate of scanner * 10 (module) 15 bit: Least significant sign bit
6	Counter	The latest counter received from the robot (unsigned)
7	Reserved	Reserved for future use
8-9	P coordinate	0-14 bits: P coordinate of robot * 10 (module) 15 bit: Least significant sign bit
10-11	R coordinate	0-14 bits: R coordinate of robot * 10 (module) 15 bit: Least significant sign bit
12-13	2D X coordinate	0-14 bits: 2D X coordinate of scanner * 10 (module)

Byte	Name	Description
		15 bit: Least significant sign bit
14-15	2D Y coordinate	0-14 bits: 2D Y coordinate of scanner * 10 (module) 15 bit: Least significant sign bit

15.6.7.3.3. Output assembly (instance 0x66)

Output assembly:

Information	Value
Class	0x04
Instance	0x66
Attribute Number	3
Length	16 bytes

Output assembly information:

Byte	Name	Description
0-1	X coordinate	0-14 bits: X coordinate of robot * 10 (module) 15 bit: Least significant sign bit
2-3	Y coordinate	0-14 bits: Y coordinate of robot * 10 (module) 15 bit: Least significant sign bit
4-5	Z coordinate	0-14 bits: Z coordinate of robot * 10 (module) 15 bit: Least significant sign bit
6-7	W coordinate	0-14 bits: W coordinate of robot * 10 (module) 15 bit: Least significant sign bit
8-9	P coordinate	0-14 bits: P coordinate of robot * 10 (module) 15 bit: Least significant sign bit
10-11	R coordinate	0-14 bits: R coordinate of robot * 10 (module) 15 bit: Least significant sign bit
12	Counter	Packet Counter (unsigned)
13	Command	Command selection (unsigned): 0 - no command, 1 - turn on the laser, 2 - turn off the laser. NOTE: If the command is identical to the previous sent command, nothing will happen.
14	Set of templates	Choosing a set of templates (unsigned): 0 - Measurement, 1 - Welding. NOTE: If the template set number is repeated, nothing will happen.
15	Template	Template selection (unsigned). NOTE: If the template number is repeated, nothing will happen.

Coordinate bits:

2 ¹⁴	2 ¹³	2 ¹²	2 ¹¹	2 ¹⁰	2 ⁹	2 ⁸	2 ⁷	2 ⁶	2 ⁵	2 ⁴	2 ³	2 ²	2 ¹	2 ⁰	Sign
-----------------	-----------------	-----------------	-----------------	-----------------	----------------	----------------	----------------	----------------	----------------	----------------	----------------	----------------	----------------	----------------	------

15.6.7.3.4. Configuration assembly (instance 0x64)

Information	Value
Class	0x04
Instance	0x64
Attribute Number	3
Length	0 bytes

15.6.8. PureUDP protocol

15.6.8.1. General information

The **PureUDP** protocol is based on the client-server model (a robot is a client, Riftek Lamia is a server) and uses the listening port 5020 by default (the server sends a response to the client to the port, which is calculated as follows: the listening port of the server + 1 (by default, 5020 + 1 = 5021). The server does not consider the device address and responds to any commands coming to the port. Data is transmitted via reading/writing of holding registers. Command codes:

Command code	Description
0x01	Read holding registers.
0x02	Write holding registers.

The **PROTOCOLS** tab with the **PureUDP** protocol selected:

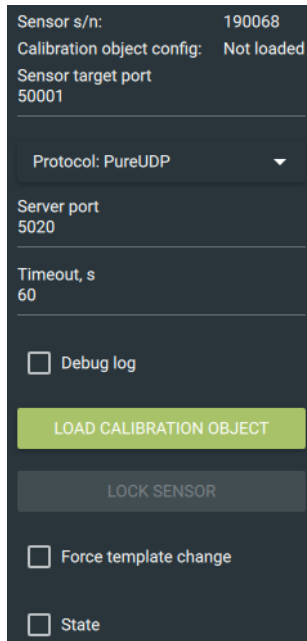

Parameters and buttons:

Parameter	Description
Sensor s/n	Serial number of the scanner.
Sensor target port	UDP port to which the scanner sends profiles (50001 by default).
Protocol	Protocol selection.
Server port	Host PC port (5020 by default).
Timeout, s	Time after which the protocol will be disabled if there are no commands or requests from the robot.
Debug log	Save the debug log: time and type of request from the robot, bytes of commands, the response time of the program, response bytes, error text.
LOAD CALIBRATION OBJECT	Load the calibration object file (for example, calibration_object_CUSTOMER_1.json). If you don't have it, contact technical support at support@riftek.com .
CALIBRATION	Show the "Calibration" panel. NOTE: This button is active only when the "State" option is enabled.
LOCK SENSOR	Lock the scanner to the protocol settings.

Parameter	Description
Force template change	Forced template change for every received packet.
State	Enable the selected protocol.



1. It is necessary to calibrate the scanner before using this protocol. See par. 15.6.8.
2. When the **State** option is enabled, you cannot change parameters in the **PROTOCOLS** tab.

15.6.8.2. Holding registers

Read holding registers:

16 bit	15 bit	Scanner 3D Point X * 10 (absolute value).
	1 bit	Least significant bit.
16 bit	15 bit	Scanner 3D Point Y * 10 (absolute value).
	1 bit	Least significant bit.
16 bit	15 bit	Scanner 3D Point Z * 10 (absolute value).
	1 bit	Least significant bit.
16 bit	8 bit	The latest counter that was received from the robot (unsigned).
	8 bit	Reserved.
16 bit	15 bit	Robot P * 10 (absolute value).
	1 bit	Least significant bit.
16 bit	15 bit	Robot R * 10 (absolute value).
	1 bit	Least significant bit.
16 bit	15 bit	Scanner 2D Point X * 10 (absolute value).
	1 bit	Least significant bit.
16 bit	15 bit	Scanner 2D Point Y * 10 (absolute value).
	1 bit	Least significant bit.

Write holding registers:

16 bit	15 bit	Robot X * 10 (absolute value).
	1 bit	Least significant bit.
16 bit	15 bit	Robot Y * 10 (absolute value).
	1 bit	Least significant bit.
16 bit	15 bit	Robot Z * 10 (absolute value).
	1 bit	Least significant bit.
16 bit	8 bit	Robot W * 10 (absolute value).
	8 bit	Least significant bit.
16 bit	15 bit	Robot P * 10 (absolute value).
	1 bit	Least significant bit.
16 bit	15 bit	Robot R * 10 (absolute value).
	1 bit	Least significant bit.
16 bit	8 bit	Packet counter (unsigned).
	8 bit	Command (unsigned): 0 - no command, 1 - laser ON, 2 - laser OFF. If the command is the same as previous, nothing will happen.
16 bit	8 bit	Template set selection (unsigned): 0 - Measurement, 1 - Welding. If the template set number is the same, nothing will happen.
	8 bit	Template selection (unsigned). If the template number is the same, nothing will happen.

15.6.8.3. Operation logic

1) The robot writes at least six registers (will be taken only six, starting with zero) by six coordinates in the following format: 15 bit - value, 1 least significant bit - sign. The float value transmitted by the robot will be multiplied by 10 in order to contain 1 digit after the point.

2) The robot reads at least eight registers. Riftek Lamia returns eight registers, containing:

- 3D coordinates (XYZ) of a point found by a template (in the robot coordinate system);
- 3 angles that were returned by the robot the last time (by a command 0x10);
- coordinates (XZ) of a point found by a template (in the scanner coordinate system).

Each value is multiplied by 10 to be transmitted and occupies 1 register. The format: 15 bit - value, 1 least significant bit - sign.

For any commands different from mentioned here, Riftek Lamia will respond with the garbage values, or write data, which will not be taken into account in Riftek Lamia.

15.6.9. Scanner calibration

15.6.9.1. "Calibration" panel



Calibration is required only for Riftek P2 and Riftek P3 protocols.

To activate the **Calibration** panel, it is necessary to select the **Riftek P2** or **Riftek P3** protocol in the **PROTOCOLS** tab and click the **CALIBRATION** button. The **Calibration** panel appears:

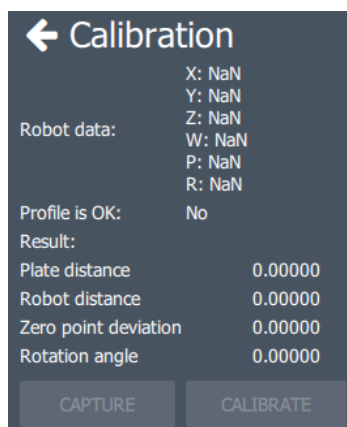

Calibration data:

Data	Description
Robot data	Current coordinates of the robot.
Profile is OK	Shows whether the current profile is suitable for calibration or not (Yes / No). The profile is taken from the scanner at the moment when the robot sends the coordinates.
Result	Calibration result (Success / Fail).

Calibration parameters:

Parameter	Maximum valid value	Description
Plate distance	0.2 mm	The standard deviation of all measured points of the plate from a reference plate at each position with a direct translation of coordinates

Parameter	Maximum valid value	Description
		from the reference system of the scanner to the reference system of the plate (test of independent calibrations of the scanner with respect to a plate).
Robot distance	1.0 mm	The standard deviation of all measured points of the plate from a reference plate at each position with indirect translation of coordinates from the reference system of the scanner to the reference system of the plate through the intermediate reference system of the arm and the reference system of the robot (scanner calibration test with respect to the arm).
Zero point deviation	1.0 mm	The standard deviation of a zero point in the reference system of the scanner (X=Z=0) during its translation to the reference system of the scanner through the reference system of the arm, robot and plate (scanner calibration test with respect to the arm).
Rotation angle	0.02 rad	Root-mean-square rotation angle of the reference system of the scanner in its conversion through the reference system of the arm, robot and plate (scanner calibration test with respect to the arm).

Buttons assignment:

Button	Assignment
CAPTURE	<p>Capture the current pair "Robot coordinates + profile". The button is active only when Robot data shows values different from NaN, and when the profile is suitable for calibration. When you click the button, the pair is added to a list below:</p> <div style="border: 1px solid gray; padding: 5px; width: fit-content; margin: 10px auto;"> <div style="display: flex; justify-content: space-between; border-bottom: 1px solid gray; padding-bottom: 5px;"> CAPTURE CALIBRATE </div> <p>Robot: XYZ : -0.6 -0.7 -0.8 WPR: -0.9 -1.0 -1.1 </p> <p>Profile: Valid</p> </div> <p>To remove a pair from a list, click </p>
CALIBRATE	Calibrate the scanner. The button is active only when there are at least 3 pairs ("Robot coordinates + profile") in the list.

To go back to the **PROTOCOLS** panel, click

15.6.9.2. Calibration procedure

1. Fix the scanner. Make sure that the scanner is immobile relative to the robot arm.
2. Determine the direction of the X axis of the scanner relative to its housing.
3. Place the calibration plate so that the arrow on the plate and the X axis of the scanner are approximately in the same direction (the angle must be less than 90°).

The plate must be immobile relative to the robot during the calibration.

4. Place the scanner so that a laser line is in the center of the plate, and the Z axis of the scanner is approximately perpendicular to the plate surface as shown in the picture below.



5. Start **Riftek Lamia** to perform the calibration:

- Click **SEARCH** to find a scanner.
- Connect to the scanner.
- Go to the **PROTOCOLS** tab and click **LOCK SENSOR**.
- Select **Riftek P2** or **Riftek P3** from a list of protocols.
- Click the **LOAD CALIBRATION OBJECT** button and select the calibration object

file.

- Specify the **Server port** (for **Riftek P2**), or the **Server address** (for **Riftek P3**).
- Enable the **Debug log** option (for **Riftek P2**).
- Enable the **State** option.
- Click the **CALIBRATION** button to open the calibration panel. When the **State**

option is enabled, the **Robot data** must show NaN values for each coordinate. If there is nothing, go back to the **PROTOCOLS** tab, disable the **State** option and enable it again.

6. Make sure that the current position of the scanner is suitable for calibration (the program must show "Profile is OK: Yes"). An example of a profile suitable for calibration is shown in the screenshot below.

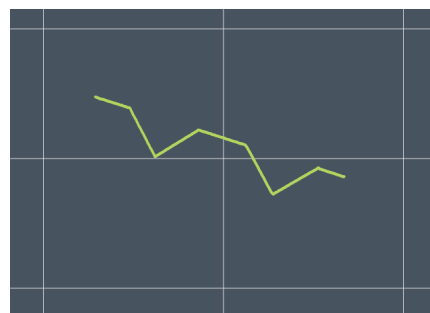

7. Click **CAPTURE**. The pair "Robot coordinates + profile" will appear below the buttons.

8. Change the position of the scanner to the most different from the previous ones (be sure to use all the angles and coordinates).

9. Repeat steps 6-8 for different positions (from 7 to 10).

10. Click **CALIBRATE** (not available when there are less than 3 pairs "Robot coordinates + profile"). The calibration process may take a long time.

11. If the result is "Success", make sure that the values of [calibration parameters](#) do not exceed the maximum valid values. Otherwise, it will be necessary to repeat the calibration.

12. The calibration is complete.

For every request from a robot, a scanner gives XYZ coordinates of the found point into the first three registers (in a robot coordinate system), and XZ coordinates of the found

point into the last two registers (in a scanner coordinate system). Before the calibration or after the failed calibration, conversion of a point to 3D is performed by using blank conversion rules or incorrect conversion rules respectively, i.e. the scanner will send invalid 3D results in such cases.

16. Firmware update

The scanner firmware can be updated only on the scanner web page. To update the firmware, go to the **Firmware update** tab.

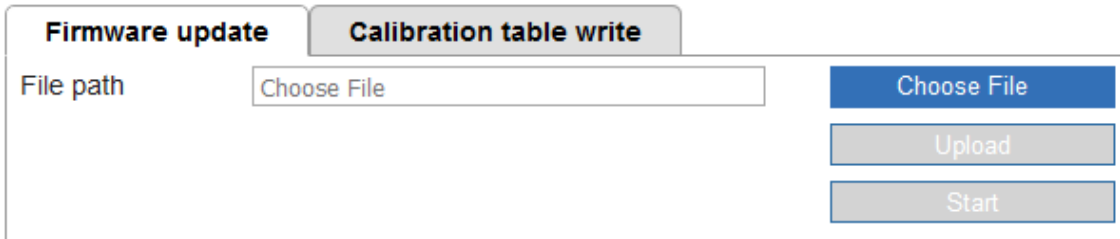

- Click **Choose File** and select the firmware file.
- Click **Upload** to upload the selected file.
- Click **Start** to start the update process. You will see:

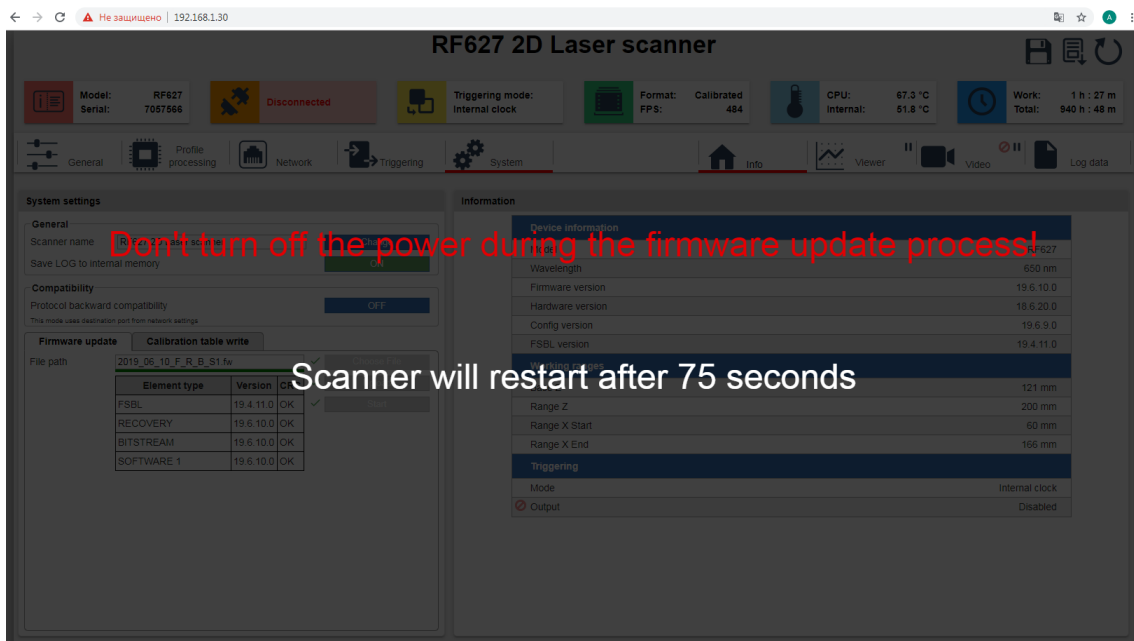

Don't turn off the power during the firmware update process!

Scanner will restart after 75 seconds

Element type	Version	OK
FSBL	19.4.11.0	OK
RECOVERY	19.6.10.0	OK
BITSTREAM	19.6.10.0	OK
SOFTWARE 1	19.6.10.0	OK

If the IP address settings haven't been changed after completing the firmware update process and restarting the scanner, the web interface will automatically reboot without waiting for the timer to expire. If the network settings have been changed, the web interface will reboot with the default IP address (192.168.1.30) after the timer expires.

17. Maintenance

Laser scanners are virtually maintenance free. As these are optical systems, they are sensitive to dust and sputter on the front windows. Cleaning is best done with a soft cloth. Do not use scratching cleaners or other aggressive media.

It is necessary to remove fingerprints from the windows, because fingerprints degrade the quality of profiles.

In order to remove fingerprints or grease, clean the windows with 20 % alcohol and soft paper.

18. Troubleshooting

Problem	Cause	Solution
No laser light	No power supply, or less than 9 V / 12 V (red laser / blue laser).	Check the power supply.
	Laser output power is too low.	Check the Laser output power parameter on the web page.
	Scanner electronics failure.	Contact the technical support.
Scanner is not detected on the network	No power supply, or less than 9 V / 12 V (red laser / blue laser).	Check the power supply.
	Ethernet cable is not connected.	Check the cable.
	Firewall doesn't pass the packages.	Add exceptions or disable the firewall.
	Scanner is already connected in another software.	Drop connections.
	Scanner freezes.	Restart the scanner.
	Scanner electronics failure.	Contact the technical support.
No profile	Incorrect Host IP address.	Make sure that the IP address of the device that receives profiles is 192.168.1.2. See section 11.
	The object is beyond the working range of the scanner.	Make sure that the object is within the working range of the scanner.
	ROI mode is enabled and the object is beyond the ROI area.	Check ROI settings on the web page.
Obtaining an incorrect profile	Scanner windows are not clean.	Clean the windows with a soft cloth (do not use scratching cleaners or other aggressive media).
	Incorrect scanner settings.	Check general settings on the web page.
Incorrect profile reflection and distortions in measurements	May occur when the current firmware version is under 20190717 and you update it to the firmware version from 20190717 to 20191112 (provided that the "Image Flip" option was used during calibration).	Update the firmware to a version later than 20191113. To restore the profile orientation, contact the technical support.

19. Warranty policy

Warranty assurance for the Laser Seam Tracking System for Welding Automation RF627Weld Series – 24 months from the date of shipping; warranty shelf-life – 12 months.

20. Technical support

Technical support for issues related to incorrect work of the system is free. When contacting technical support, please provide the serial number and firmware version of the scanner, Riftek Lamia version, and describe the problem in details.

Technical support contacts:

- E-mail: support@riftek.com
- Skype: riftek_support

21. Revisions

Date	Revision	Description
19.08.2019	1.0.0	Starting document.
12.05.2020	1.1.0	Updated the description of the Riftek Lamia software.
03.08.2020	1.1.1	Updated Figures 2, 3, 4 in par. 7.1.2 .