

RD Standard differential pressure switches

Pneumatics or hydraulic fluid control

Power generation safety equipments

Pressurized chambers control

Level measurement

Conforms to CE

These instruments compare a pre-established adjustable set point to the received process pressure.

Equipped with one or two snap action microswitches, they are used for controlling the process cycles, or operate an alarm when pressure reaches set point value.

Depending on options selected, adjustable differential deadband is available. Featuring possibility to adjust change on rise and change on fall limits or enabling to get rid of undesired repetitive on/off around set point.



Technical Data (20°C)

Operating temperature	See pages 2 and 3
Storage temperature	From - 40...70 °C
Reproductibility	± 2 % of F.S.
Reading accuracy	± 5 % of full scale
Conform to CE	Low Voltage Directive DBT 73/23/CE Pressure Directive PED 97/23/CE
Degree of protection	IP 65, NF EN 60529

Manufacturing

Cover	Blue ZAMAK protected Captive screws for cover attachment
Case	Black ZAMAK protected
Wall mounting	Removable bracket
Earth connection	Internal
Electrical connection	Internal terminal block with P.E. 11 cable gland for cable between 7 and 10.5 mm diameter
Pressure connection	G 1/2 or female 1/4 NPT
Adjustment element	External adjustment screw fitter with an antivibration system locking the set point and the deadband, protected by screwed lead seal on in option Internal mechanism of bichromate - treated cadmium-plated steel

Important

Normal operation is between 10 % and 90 % of the selected scale. Deadband values given in the table (see overleaf) are defined under these conditions.

All circuits must be equipped with a safety system protecting them against excess pressure.

All pulsating circuits must be fitted with pulsation dampeners. When mechanical vibrations are present, these should be reduced as much as possible by installing the pressure switches on antivibration mounts. For the switch to be correctly calibrated, the operating static pressure must be known.

**BOURDON
HAENNI**

made to measure



Operating ranges

RDDP - RDPN - RDPH - RDHN low pressure

RDDP : standard sensing element with treated steel flanges and diaphragm Viton.

RDPN : standard sensing element with 1.4404 (316L) stainless steel flange and Viton diaphragm.

SCALE	Code	Maxi P	static P Maxi	MICROSWITCH								DIMENSIONS
				Adjustable deadband				Max Fixed deadband		Max Fixed deadband		
				N (tropicalized) At 10 % of scale	A (SI) At 90 % of scale	M (gold) At 10 % of scale	C (SH) At 90 % of scale	E (GS) At 10 % of scale	E (GS) At 90 % of scale	H (SRC) At 10 % of scale	D (GSH) At 90 % of scale	J (SRJ) At 90 % of scale
mbar		mbar	bar	mbar	mbar	mbar	mbar	mbar	mbar	mbar	mbar	
2.5 to +2.5	110	5	0.15					0.3	0.4			
2 to 10	111	10	0.15	1.2 to 10	1.6 to 10	4.5 to 10	4.5 to 10	0.3	0.4	1.5	2	Fig. 1
2 to 50	121	50	0.15	1.7 to 30	2.2 to 30	5 to 30	5.5 to 30	0.4	0.5	2	3	Fig. 1
2 to 100	131	100	0.15	1.7 to 40	2.5 to 40	5.5 to 40	10 to 40	0.5	0.7	2	3	Fig. 1
10 to 200	156	200	1	8 to 80	10.5 to 80	25 to 80	40 to 80	2.5	3.4	10	13	Fig. 2
10 to 400	157	400	1	15 to 150	20 to 150	30 to 150	45 to 150	4.5	6	18	24	Fig. 2

RDPH : sensing element with standing overpressures with treated steel flanges and diaphragm Viton

RDHN : sensing element with standing overpressure with 1.4404 (316L) stainless steel flanges and diaphragm according to (1), (3).

SCALE	Code	Maxi P	static P Maxi	MICROSWITCH								DIMENSIONS
				Adjustable deadband				Max Fixed deadband		Max Fixed deadband		
				N (tropicalized) At 10 % of scale	A (SI) At 90 % of scale	M (gold) At 10 % of scale	C (SH) At 90 % of scale	E (GS) At 10 % of scale	E (GS) At 90 % of scale	H (SRC) At 10 % of scale	D (GSH) At 90 % of scale	J (SRJ) At 90 % of scale
mbar		mbar	bar	mbar	mbar	mbar	mbar	mbar	mbar	mbar	mbar	
2 to 10	111 ⁽¹⁾	10	0 to 5	1.2 to 10	1.6 to 10	4.5 to 10	4.5 to 10	0.3	0.4	1.5	2	Fig. 3
2 to 20	112 ⁽³⁾	50	0 to 5	1.7 to 20	2.2 to 20	5 to 20	5.5 to 20	0.4	0.5	2	3	Fig. 3
2 to 50	121 ⁽³⁾	50	0 to 5	1.7 to 30	2.2 to 30	5 to 30	5.5 to 30	0.4	0.5	2	3	Fig. 3
2 to 100	131 ⁽³⁾	100	0 to 5	1.7 to 40	2.5 to 40	5.5 to 40	10 to 40	0.5	0.7	2	3	Fig. 3
10 to 200	156 ⁽¹⁾	200	5.5 to 50	8 to 80	10.5 to 80	35 to 80	45 to 80	2.5	3.4	10	13	Fig. 4
10 to 400	157 ⁽¹⁾	400	5.5 to 50	15 to 150	20 to 150	40 to 150	50 to 150	4.5	6	18	24	Fig. 4
10 to 1000	158 ⁽¹⁾	1000	5.5 to 50	18 to 150	22 to 150	45 to 150	60 to 150	5	7	22	26.5	Fig. 4
10 to 700	161 ⁽¹⁾	700	5.5 to 80	20 to 200	30 to 200	60 to 350	90 to 350	6	8	24	36	Fig. 5
10 to 1500	162 ⁽¹⁾	1500	5.5 to 80	20 to 300	30 to 300	60 to 350	100 to 350	6	8	24	36	Fig. 5
10 to 2000	163 ⁽¹⁾	2000	5.5 to 80	30 to 300	60 to 300	90 to 350	200 to 350	9	12	36	72	Fig. 5

- (1) Viton diaphragm
(3) Nitrile, Butyl rubber diaphragm

T° fluid : -15... 150° C
T° ambient : -10... 55° C

} RDDP/RDPN
} RDPH/RDHN

These microswitches can be implemented with two simultaneous contacts : W (2xC)

Warning : in this case, deadbands are multiplied by 1.5

For microswitches G : consult us

Operating ranges

RDPW - RDWN low pressure, RDDP - RDPN medium pressure

RDPW : standard sensing element, treated steel flanges, EPDM diaphragm not perturbed by static pressure variations.

RDWN : standard sensing element, 1.4404 (316L) stainless steel flanges and Viton diaphragm, not perturbed by static pressure variations.

SCALE	Code	Maxi P	Static P Maxi	MICROSWITCH								DIMENSIONS
				Adjustable deadband				Max Fixed deadband		Max Fixed deadband		
				N (tropicalized) (SI) At 10 % of scale	A (SI) At 90 % of scale	M (gold) At 10 % of scale	C (SH) At 90 % of scale	E (GS) At 10 % of scale		H (SRC) At 10 % of scale	D (GSH) At 90 % of scale	
mbar		mbar	bar	mbar	mbar	mbar	mbar	mbar	mbar	mbar	mbar	
10 to 200	156	200	20	8 to 80	10.5 to 80	35 to 80	45 to 80	2.5	3.4	10	13	Fig. 6
10 to 400	157	400	20	15 to 150	20 to 150	40 to 150	50 to 150	4.5	6	18	24	Fig. 6
10 to 1000	158	1000	20	18 to 150	22 to 150	45 to 150	60 to 150	5	7	22	26.5	Fig. 6
10 to 700	161*	700	20	30 to 250	45 to 250	130 to 450	150 to 450	13	15	36	54	Fig. 7
10 to 1500	162*	1500	20	30 to 300	45 to 300	130 to 450	150 to 450	13	15	36	54	Fig. 7
10 to 2000	163*	2000	20	45 to 300	90 to 300	180 to 450	300 to 450	18	25	54	108	Fig. 7

T° fluid : -15...150° C

* G 1/4 : female connection

T° ambient : -10...55° C

RDDP : standard sensing element with brass base plate, Tombac bellow or nickel-plated piston.

RDPN : standard sensing element with stainless steel base plate, stainless steel bellow or nickel plated piston.

SCALE	Code	Maxi P	static P Maxi	MICROSWITCH								DIMENSIONS
				Adjustable deadband				Max Fixed deadband		Max Fixed deadband		
				N (tropicalized) (SI) At 10 % of scale	A (SI) At 90 % of scale	M (gold) At 10 % of scale	C (SH) At 90 % of scale	E (GS) At 10 % of scale		H (SRC) At 10 % of scale	D (GSH) At 90 % of scale	
bar		bar	bar	bar	bar	bar	bar	mbar	mbar	bar	bar	
0.05 to 0.5	211	0.5	7	0.09 to 0.3	0.1 to 0.3	0.15 to 0.4	0.2 to 0.4	25	30	0.11	0.12	Fig. 1
0.05 to 1	221	1	7	0.09 to 0.3	0.1 to 0.3	0.15 to 0.4	0.22 to 0.4	25	30	0.11	0.12	Fig. 1
0.15 to 0.5	214*	0.5	15	0.14 to 0.5	0.18 to 0.5	-	-	55	60	0.17	0.22	Fig. 2
0.15 to 1	224*	1	15	0.14 to 0.6	0.20 to 0.6	-	-	55	60	0.17	0.24	Fig. 2
0.15 to 4	234*	4	15	0.14 to 1.5	0.25 to 1.5	0.65 to 2	0.8 to 2	55	65	0.17	0.3	Fig. 2
0.8 to 4	235	4	30	0.7 to 2.5	1.1 to 2.5	0.75 to 2.5	1.1 to 2.5	70	100	0.84	1.35	Fig. 2
0.8 to 10	245	10	30	0.7 to 2.5	1.1 to 2.5	0.75 to 2.5	1.1 to 2.5	70	100	0.84	1.35	Fig. 2
1.5 to 10	246	10	65	1.2 to 5	2.5 to 5	2.5 to 6	3.5 to 6	180	240	1.45	3	Fig. 2
1.5 to 20	256	20	65	1.2 to 5	2.5 to 5	2.5 to 6	3.5 to 6	180	240	1.45	3	Fig. 2
2.5 to 20	257**	20	220	2.5 to 20	3.5 to 20	6 to 20	7 to 20	800	1000	3	4.2	Fig. 2
2.5 to 30	258**	30	220	3 to 20	4 to 20	6 to 20	7 to 20	850	1000	3.6	4.8	Fig. 2
15 to 120	651	120	600	15 to 100	25 to 100	25 to 100	35 to 100	12 bar	15 bar	18	30	Fig. 2

* Static P maxi = 30 bar for stainless steel version

** measuring element in stainless steel only

T° fluid : -50... 80° C (RDDP)

-50... 200° C (RDPN)

T° ambient : -25... 55° C (all versions)

These microswitches can be implemented with two simultaneous contacts : W (2x C)

Warning : in this case, deadbands are multiplied by 1.5

For microswitches G : consult us

Cable identification, current rating

Cable identification

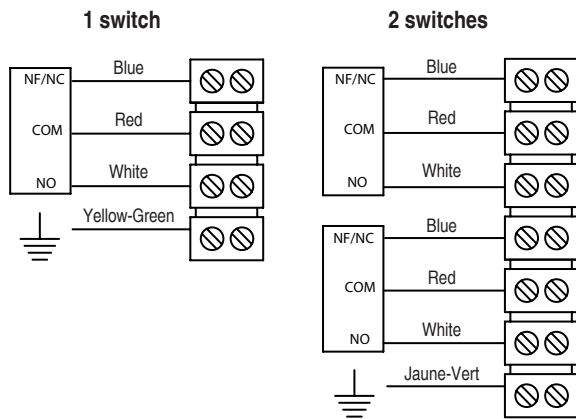

Current rating

Microswitch type SPDT

A	Standard Adjustable deadband	0.1 A min.; 10 A max. 250 Vac max. or 220 Vcc max.
B	2 simultaneous contact Adjustable deadband	0.1 A min.; 10 A max. 250 Vac max. or 220 Vcc max.
C	Hermetic Adjustable deadband	5 mA min.; 4A max. 250 Vac max. or 220 Vcc max.
W	2 hermetically contact Adjustable deadband	5 mA min.; 4A max. 250 Vac max. or 220 Vcc max.
E	Ultra sensitive Fixed deadband	0.2 A min.; 10A max. 250 Vac max. or 30 Vcc max.
F	2 contacts ultra sensitive Fixed deadband	0.2 A min.; 10A max. 250 Vac max. or 30 Vcc max.
G	2 contacts décalables Fixed deadband	0.2 A min.; 10A max. 250 Vac max. or 30 Vcc max.
D	Hermetically ultra sensitive Fixed deadband	0.4 A min.; 10A max. 30 Vcc max.
V	2 hermetically contact ultra sensitive Fixed deadband	0.4 A min.; 10A max. 30 Vcc max.
M	Gold contact Adjustable deadband	10 mA min.; 50 mA max. 250 Vac max. or 220 Vdc max.
N	Tropicalized Adjustable deadband	0,1 A min.; 10A max. 250 Vac max. or 48 Vdc max.
H	1 changeover switch with manual reset opening on rise Fixed deadband	0.1 A min.; 10A max. 250 Vac max. or 30 Vcc max.
J	1 changeover switch with manual reset opening on fall Fixed deadband	0.1 A min.; 10A max. 250 Vac max. or 30 Vcc max.

Operating principle

An element which is sensitive to a differential pressure actuates one or two microswitches via levers. The set point and the deadband are adjusted by springs.

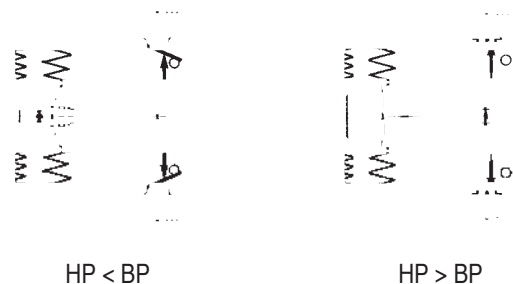

Accessories

Adaptor for welded connection :
in steel ZRM1 or stainless steel ZRMN1

Steel or s.s. 1.4401 (AISI 316) siphon

Chemical seal (for code 221 to 451)

Isolating valve.

Manifold.

Pulsation dampener.

Dimensions (mm)

Watertight case



Sensing element RDDP / RDPN / RDPH / RDHN / RDPW / RDWN low pressure range

Fig.1
RDDP / RDPN - 110 - 111 - 121 - 131
weight : 3 kg

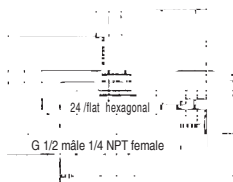

Fig.2
RDDP / RDPN - 156 - 157
weight : 2.8 kg

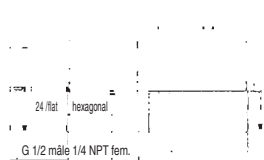

Fig.3
RDPH / RDHN - 111 - 121 - 131
weight : 10 kg

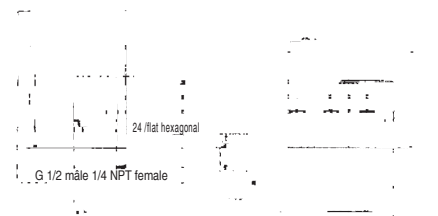

Fig.4
RDPH / RDHN - 150
weight : 6.4 kg

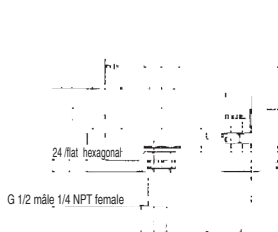

Fig.5
RDPH / RDHN - 160
weight : 7 kg

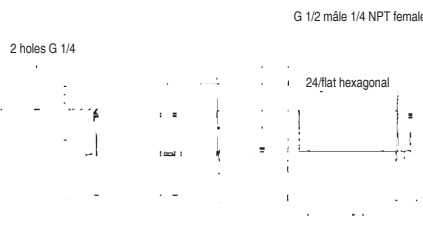
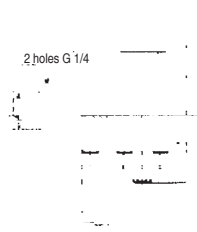

Fig.6
RDPW / RDWN - 150
weight : 6.6 kg



Fig.7
RDPW / RDWN - 160
weight : 7 kg



Dimensions (mm)

RDDP / RDPN medium pressure range

Fig.1
RDDP / RDPN 211 - 221
weight : 3 kg

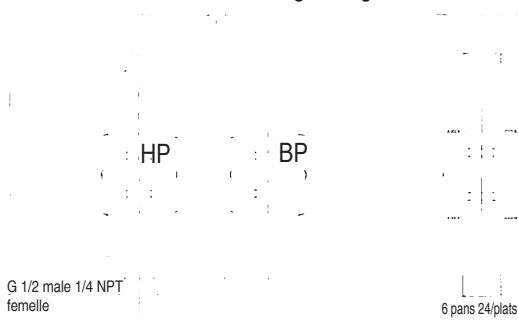
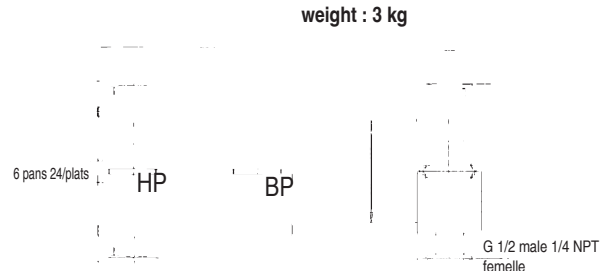

Fig.2
RDDP / RDPN 214 - 224 - 234 - 235 - 245 -
246 - 256 - 257 - 258 - 651
weight : 3 kg



Options

Other cables glands
 All stainless steel construction (screws and sensing element)
 for aggressive environments
 French electricity (EDF) version
 (consult SEPTEN ZDP, ZDPH, ZDPW leaflet)
 Specific connection

Cleanliness for oxygen service **Code 0765**
 Stainless steel tag plate and wire **Code 9941**
 Connection on pipe 2 " dia. **Code 0407**
 Adjustment of the set point **Code SETP**

Ordering Details - RD

		RDxxxxxxxx				
Model	1' digit					
Pressostat		R				
Type	2'...4' digit					
Code 110 to 163						
DDP			DDP			
DPH			DPH			
DPW			DPW			
DPN			DPN			
DPHN			DHN			
DPWN			DWN			
Code 211 to 651						
DDP			DDP			
DPN			DPN			
Microswitch **	5' digit					
1 standard changeover switch			A			
2 simultaneous changeover switches			B			
1 hermetically changeover switch			C			
1 hermetically scaled ultra sensitive changeover switch			D			
1 ultra sensitive changeover switch			E			
2 ultra sensitive changeover switches			F			
2 movable changeover switches			G			
2 hermetically ultra sensitive changeover switches			V			
2 hermetically changeover switches			W			
1 gold contact changeover switch			M			
1 tropicalized changeover switch			N			
1 changeover switch with manual reset opening on rise			H			
1 changeover switch with manual reset opening on fall			J			
Pneumatic changeover NO			Z			
Pneumatic changeover NF			Y			
Protection	6' digit					
Standard			A			
Hydraulic connection	7' digit					
G 1/4 female (161, 162, 163 only)			H			
G 1/2			3			
1/2 NPT male			6			
1/4 NPT female			8			
Pressure range	8'...10' digit					
See codes in table					xxx	

Code	Measurement range mbar	RDDP RDPN	RDPH RDHN	RDPW RDWN
110	-2.5 + 2.5	X		
111	2 + 10	X	X	
112	2 + 20		X	
121	2 + 50	X	X	
131	2 + 100	X	X	
156	10 + 200	X	X	X
157	10 + 400	X	X	X
158	10 + 1000		X	X
161	10 + 700		X	X
162	10 + 1500		X	X
163	10 + 2000		X	X

Code	Measurement range bar	RDDP RDPN
211	0.05 + 0.5	X
221	0.05 + 1	X
214	0.15 + 0.5	X
224	0.15 + 1	X
234	0.15 + 4	X
235	0.8 + 4	X
245	0.8 + 10	X
246	1.5 + 10	X
256	1.5 + 20	X
257	2.5 + 20	X
258	2.5 + 30	X
651	15 + 120	X

** SPDT microswitches only

Electronuclear versions: ZDPN-SHM or CHM, ZDPH-SHM or CHM, ZDPW-SHM or CHM