

# D-150-G/R-150-G SERIES

Self-Modulating Temperature Control Valves



## Technical Specifications

Simple yet efficient design requires minimum maintenance. Heavy duty construction assures long valve life. Valves are temperature actuated, self-powered, fully balanced, and applicable to heating (D-150-G) or cooling (R-150-G) processes using water, oil, steam or other fluids

### Features

#### Standard Features

- *Self Contained, Completely Automatic* - Simply install and set temperature from a variety of ranges. No further adjustments or external power required.
- *Compact Design* - Requires minimum installation space with minimum piping requirements.
- *Versatile* - Designed for a wide variety of applications, both heating and cooling.

Minimal pressure drop across valve

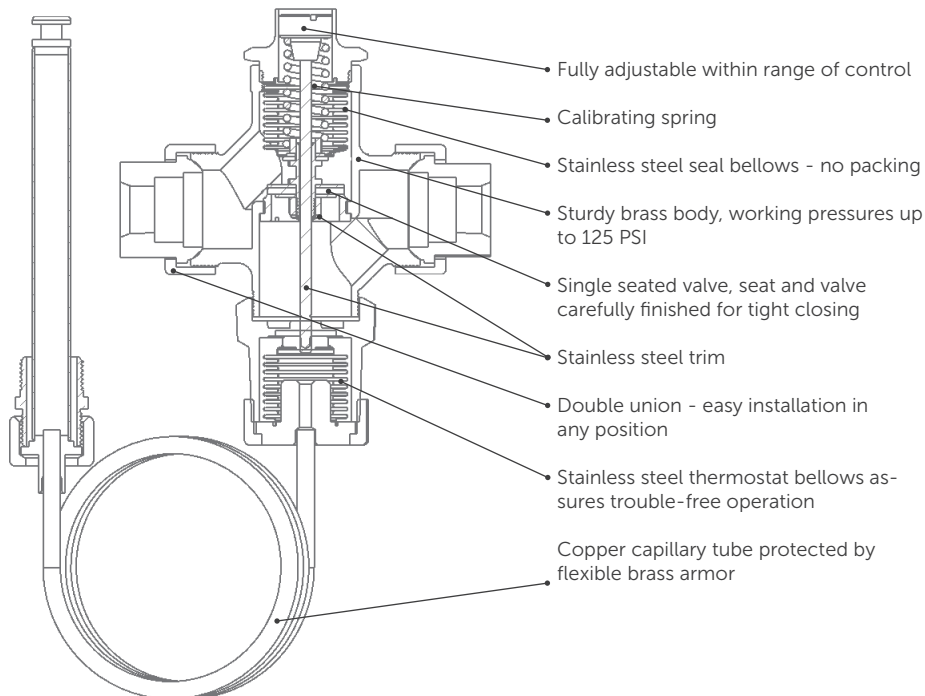

Free-flowing, modulating valve provides energy savings with continuous and accurate control

#### Optional Features

- Flanged bulb for duct mounting
- Calibrated adjusting screw with wheel handle for quick adjustment
- Plain brass bulb, less adaptor, for open tank or cabinet mounting
- Brass bulb with lock nut for bracket mounting
- Union fitting on capillary for closed tank
- 6 ft. plastic coated capillary and bulb for plating tanks (no tank adaptor)
- 6 ft. stainless steel capillary and bulb
- 1/16" weephole on outlet side of valve for constant flow
- Brass and stainless steel bulb wells
- Other options available - consult factory

## Specifications

### Heating - Steam Requirements

Use the chart to the right to find the amount of steam required to heat a given amount of water. The example shows that, if it is desired to heat 450 GPH of water from 60° to 160°F (100° rise), the amount of steam required would be 350 lbs./hr. For fuel oil, about half as much steam is required. Using the same figures as to the right for example - 450 GPH of oil and 100°F rise, the steam requirement would be 350/2 or 175 lbs./hr.

| Inlet & Outlet Sizes | Cv   | Weight, lbs. | For HEATING<br>closes on rising temperature | For COOLING<br>opens on rising temperature |
|----------------------|------|--------------|---|--|
|                      |      |              | Series No.<br>Direct-acting                 | Series No.<br>Reverse-acting               |
| 1/2"                 | 3.03 | 8            | D-150-G                                     | R-150-G                                    |
| 3/4"                 | 6.03 | 8            | D-151-G                                     | R-151-G                                    |
| 1"                   | 9.51 | 8            | D-152-G                                     | R-152-G                                    |

- Pressure ratings - lbs. **0-125**
- Inlet & outlet **Double union**
- Valve body - straightway **Brass body**
- Valve trim **Stainless steel seat and stainless steel & silicone valve disc**
- Valve construction **Single-seated, balanced, with stainless steel seal bellows**
- Standard capillary length **6', longer or shorter Lengths available.**
- Standard temperature ranges available **55°-95°F 130°-170°F**  
**85°-125°F 150°-190°F**  
**105°-145°F 175°-215°F**  
**185°-225°F**

Special: **80°-170°F**  
temperature ranges **110°-190°F**  
(other ranges available - consult factory for details) **165°-225°F**

*NOTE: When ordering, specify size, model number, temperature range, capillary length, working pressure, shut-off temperature (controls are factory set at middle of range unless otherwise specified)*

### Valve Operates In Any Mounting Position

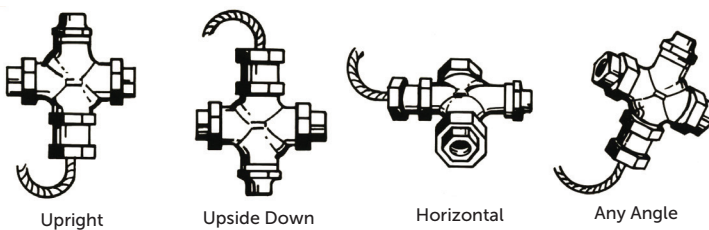

### Capacities and Sizing

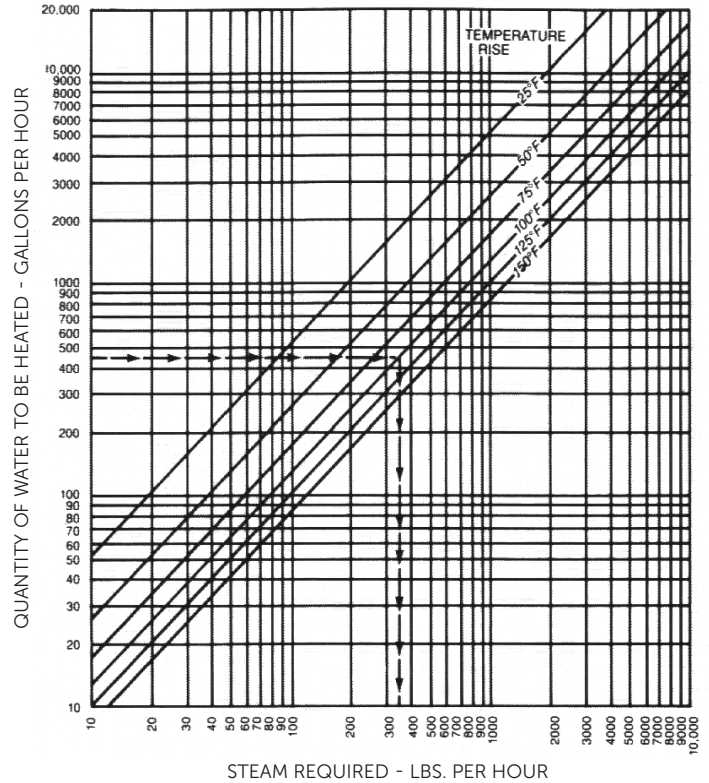

### Dimensions D-150-G and R-150-G Controls

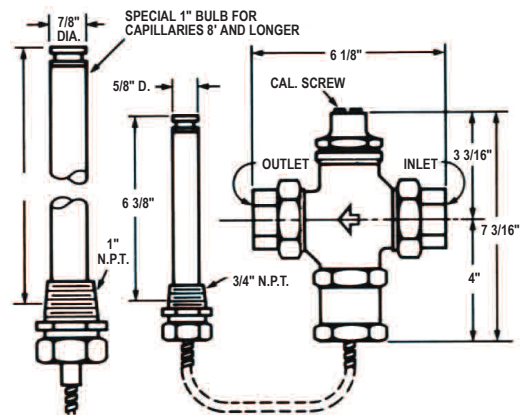

### Bulb Wells - Available in stainless steel or brass

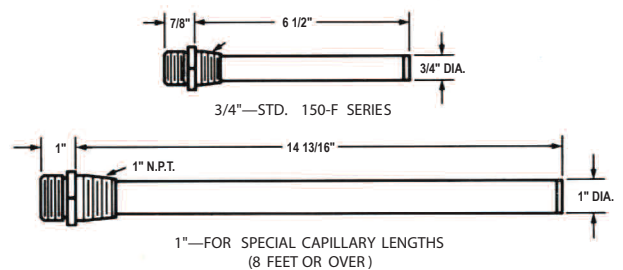

## Specifications

### Heating - Valve Size

Use this chart to determine the correct size valve to deliver a given amount of steam. The example shows that, if 350 lbs./hr. of steam is required and the steam pressure drop available at the control is 50 lbs./sq. in., a 3/4" D-151-G control valve will be adequate.

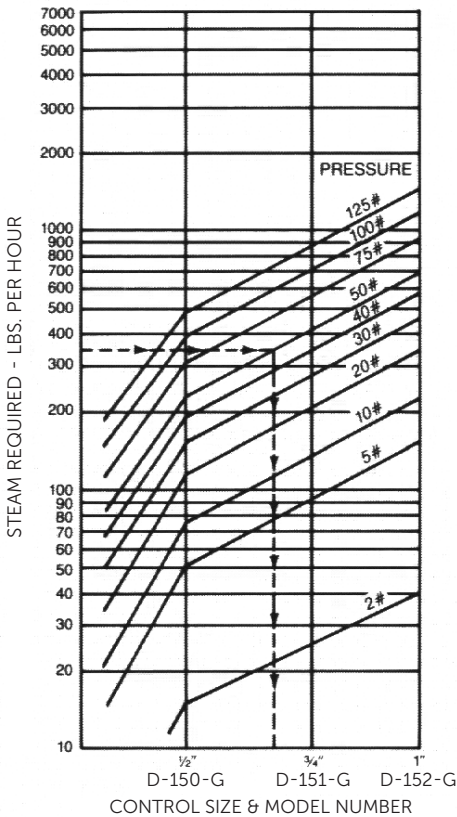

### Cooling - Water

Use this chart to find the correct size reverse-acting or cooling valve to deliver the required water flow. In the example shown, a requirement of 52 G.P.M. at 100 lbs./sq. in. supply pressure indicates that a 3/4" R-151-G control valve will be needed.

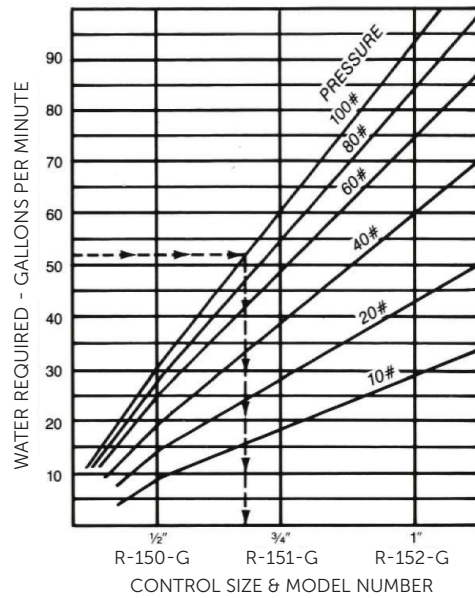

## Typical Applications

### D-150-G Heating - Storage Water Heater

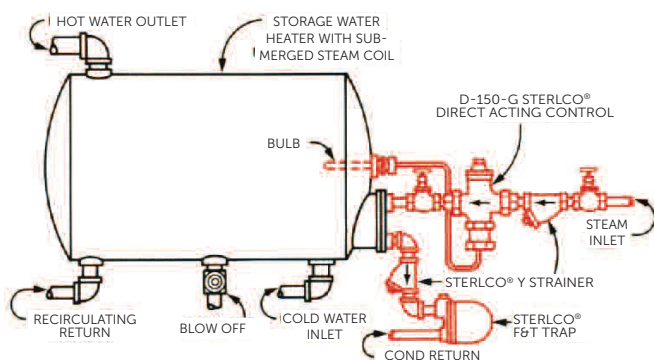

### R-150-G Cooling - Heat Exchanger

